

DETAILS

Product Number	F13325_ANGELINA-S
Family	ANGELINA
Type	Reflector
Color	metal
Diameter	82 mm
Height	31 mm
Style	round
Optic Material	PC
Holder Material	
Fastening	
Status	production ready
ROHS Compliant	Yes
Date Updated	31/01/2017



OPTICAL PROPERTIES

LED	Viewing Angle	Light Beam	Efficiency	cd/lm	Connector
BXRA ES Rectangle	17 deg	Spot	94 %	3.000	IDEAL: 50-2100BL + 50-2100AN
V22 Gen6	29 deg	Spot	92 %	1.600	IDEAL: 50-2204-CT + 50-2100AN
V13 Gen7	20 deg	Spot	94 %	2.600	TE: 2213254-2 + OPTIC CLIP Z50 TYPE1 2213194-1
V22 Gen7	sim: 21	Spot	sim: 94 %	sim: 3.038	IDEAL: 50-2204-CT + 50-2100AN
V13 Gen7	sim: 16	Spot	sim: 93 %	sim: 4.580	IDEAL: 50-2103CT + 50-2100AN
CLL03x/CLU03x	19 deg	Spot	94 %	2.710	IDEAL: 50-2103CT + 50-2100AN
CLL03x/CLU03x	22 deg	Spot	94 %	2.450	TE: 2213254-2 + OPTIC CLIP Z50 TYPE1 2213194-1
CLU720/721	17 deg	Spot	94 %	2.700	TE: 2213254-2 + OPTIC CLIP Z50 TYPE1 2213194-1
CLU720/721	15 deg	Spot	94 %	3.100	IDEAL: 50-2103CT + 50-2100AN
CLL04x/CLU04x	30 deg	Spot	92 %	1.600	IDEAL: 50-2204-CT + 50-2100AN
CLU730/731	18 deg	Spot	92 %	2.700	IDEAL: 50-2204-CT + 50-2100AN
CXA/B 30xx	28 deg	Spot	94 %	1.730	IDEAL: 50-2234C + 50-2100AN
CXA/B 25xx	22 deg	Spot	94 %	2.280	IDEAL: 50-2102CR + 50-2100AN
CXA/B 1816 & CXA/B 1820 & CXA 1850	16 deg	Spot	94 %	3.290	IDEAL: 50-2101CR + 50-2100AN
CXA/B 3590	40 deg	Spot	93 %	1.190	IDEAL: 50-2303CR + 50-2300AN
COB 10W/13W/17W/24W	17 deg	Spot	94 %	3.020	IDEAL: 50-2100LG + 50-2100AN
LUXEON K16	22 deg	Spot	94 %	2.320	TE: 2213134-2 + OPTIC CLIP Z50 TYPE1 2213194-1
LUXEON K12	20 deg	Spot	94 %	2.660	TE: 2213134-2 + OPTIC CLIP Z50 TYPE1 2213194-1
LUXEON CoB 1204/1205	19 deg	Spot	94 %	3.100	TE: 2213130-2 + OPTIC CLIP Z50 TYPE1 2213194-1
LUXEON CoB 1208	21 deg	Spot	93 %	2.700	TE: 2213130-2 + OPTIC CLIP Z50 TYPE1 2213194-1
LUXEON CoB 1204/1205	17 deg	Spot	94 %	2.980	IDEAL: 50-2100SH + 50-2100AN
LUXEON CoB 1208	20 deg	Spot	94 %	2.610	IDEAL: 50-2100SH + 50-2100AN
LUXEON CoB 1211	26 deg	Spot	91 %	1.700	IDEAL: 50-2204-CT + 50-2100AN
CXM-14	20 deg	Spot	94 %	2.530	TE: 2213254-2 + OPTIC CLIP Z50 TYPE1 2213194-1
COB L-Type (LES 11)	16 deg	Spot	91 %	3.080	IDEAL: 50-2100NC + 50-2100AN

OPTICAL PROPERTIES

LED	Viewing Angle	Light Beam	Efficiency	cd/lm	Connector
COB J-Type	20 deg	Spot	94 %	2.530	IDEAL: 50-2103NC + 50-2100AN
COB L-Type (LES 11)	22 deg	Spot	94 %	2.160	Molex: 180580-0005
COB L-Type (LES 11)	17 deg	Spot	92 %	2.660	TE: 2213382-2 + OPTIC CLIP Z50 TYPE1 2213194-1
PrevaLED Core Z3 LES9	14 deg	Spot	94 %	3.800	TE: OPTIC CLIP Z50 TYPE1 2213194-1
PrevaLED Core Z3 LES19	23 deg	Spot	94 %	2.210	TE: OPTIC CLIP Z50 TYPE1 2213194-1
PrevaLED Core Z3 LES23	27 deg	Spot	94 %	1.800	TE: OPTIC CLIP Z50 TYPE1 2213194-1
Soleriq S13	20 deg	Spot	94 %	2.800	TE: 2213401-2 + OPTIC CLIP Z50 TYPE1 2213194-1
Soleriq S19	22 deg	Spot	94 %	2.380	TE: 2213407-2 + OPTIC CLIP Z50 TYPE1 2213194-1
PrevaLED Core AC (LEP-800)	16 deg	Spot	94 %	3.100	TE: OPTIC CLIP Z50 TYPE1 2213194-1
PrevaLED Core AC (LEP-2000)	23 deg	Spot	93 %	2.100	TE: OPTIC CLIP Z50 TYPE1 2213194-1
PrevaLED Core Z4 LES19	21 deg	Spot	94 %	2.300	TE: OPTIC CLIP Z50 TYPE1 2213194-1
Soleriq P13	20 deg	Spot	93 %	2.510	TE: 2213401-2 + OPTIC CLIP Z50 TYPE1 2213194-1
Soleriq S13 Gen2	19 deg	Spot	93 %	2.700	TE: 2213254-2 + OPTIC CLIP Z50 TYPE1 2213194-1
Soleriq S13 Gen2	17 deg	Spot	91 %	2.600	IDEAL: 50-2103CT + 50-2100AN
Fortimo SLM 2000 G3	24 deg	Spot	91 %	2.300	TE: OPTIC CLIP Z50 TYPE1 2213194-1
Fortimo SLM 3000 G3	24 deg	Spot	91 %	2.300	TE: OPTIC CLIP Z50 TYPE1 2213194-1
Fortimo SLM 4500 G3	28 deg	Spot	89 %	1.900	TE: OPTIC CLIP Z50 TYPE1 2213194-1
Fortimo LED SLM L9 G4 standard	15 deg	Spot	94 %	3.400	TE: OPTIC CLIP Z50 TYPE1 2213194-1
Fortimo LED SLM L13 G4 standard	18 deg	Spot	94 %	2.900	TE: OPTIC CLIP Z50 TYPE1 2213194-1
Fortimo LED SLM L15 G4 standard	20 deg	Spot	93 %	2.400	TE: OPTIC CLIP Z50 TYPE1 2213194-1
Fortimo LED SLM L19 G4 standard	26 deg	Spot	92 %	1.900	TE: OPTIC CLIP Z50 TYPE1 2213194-1
Fortimo SLM G5 LES 9 Standard	15 deg	Spot	92 %	3.200	TE: OPTIC CLIP Z50 TYPE1 2213194-1
Fortimo SLM G5 LES 15 Standard	21 deg	Spot	91 %	2.240	TE: OPTIC CLIP Z50 TYPE1 2213194-1
Fortimo SLM G5 LES 19 Standard	26 deg	Spot	90 %	1.770	TE: OPTIC CLIP Z50 TYPE1 2213194-1
Fortimo SLM G5 LES 13 Standard	19 deg	Spot	92 %	2.600	TE: OPTIC CLIP Z50 TYPE1 2213194-1
Fortimo SLM 1211 L19 G6 Standard	26 deg	Spot	92 %	1.800	TE: OPTIC CLIP Z50 TYPE1 2213194-1
LC026B/LC040B	24 deg	Spot	93 %	2.100	TE: 2213258-2 + OPTIC CLIP Z50 TYPE1 2213194-1
LC040C	18 deg	Spot	92 %	2.600	TE: 2213382-2 + OPTIC CLIP Z50 TYPE1 2213194-1
Mega Zenigata (GW6DME)	21 deg	Spot	92 %	2.770	TE: 2213130-2 + OPTIC CLIP Z50 TYPE1 2213194-1
Mega Zenigata (GW6DME)	20 deg	Spot	94 %	2.650	IDEAL: 50-2100SH + 50-2100AN
STARK SLE G2 LES19	22 deg	Spot	92 %	2.600	TE: OPTIC CLIP Z50 TYPE1 2213194-1
STARK SLE G2 LES23	26 deg	Spot	91 %	2.100	TE: OPTIC CLIP Z50 TYPE1 2213194-1
STARK SLE G2 LES26	28 deg	Spot	90 %	1.800	TE: OPTIC CLIP Z50 TYPE1 2213194-1
STARK SLE G3 LES19	23 deg	Spot	90 %	2.200	TE: OPTIC CLIP Z50 TYPE1 2213194-1
STARK SLE G3 LES23	28 deg	Spot	91 %	1.800	TE: OPTIC CLIP Z50 TYPE1 2213194-1
SLE G4 LES23 H	28 deg	Spot	93 %	1.700	TE: OPTIC CLIP Z50 TYPE1 2213194-1
SLE G4 LES19 H	22 deg	Spot	92 %	2.300	TE: OPTIC CLIP Z50 TYPE1 2213194-1
SLE G5 LES15	20 deg	Spot	93 %	2.500	TE: 2213254-2 + OPTIC CLIP Z50 TYPE1 2213194-1
SLE G5 LES19 H	23 deg	Spot	94 %	2.200	TE: OPTIC CLIP Z50 TYPE1 2213194-1
SLE G5 LES23 H	28 deg	Spot	94 %	1.760	TE: OPTIC CLIP Z50 TYPE1 2213194-1
WU-M-461	20 deg	Spot	94 %	2.660	TE: OPTIC CLIP Z50 TYPE1 2213194-1
WU-M-462	26 deg	Spot	94 %	2.030	TE: OPTIC CLIP Z50 TYPE1 2213194-1



PRODUCT DATASHEET
ANGELINA series
last update 31/1/2017

WU-M-464

26 deg

Spot

94 %

2.040

TE: OPTIC CLIP Z50 TYPE1 2213194-1



PRODUCT DATASHEET
ANGELINA series
last update 31/1/2017

WU-M-484

21 deg

Spot

93 %

2.430

TE: OPTIC CLIP Z50 TYPE1 2213194-1



PRODUCT DATASHEET
ANGELINA series
last update 31/1/2017

WU-M-485

27 deg

Spot

93 %

1.870

TE: OPTIC CLIP Z50 TYPE1 2213194-1



PRODUCT DATASHEET
ANGELINA series
last update 31/1/2017

WU-M-486

26 deg

Spot

93 %

1.880

TE: OPTIC CLIP Z50 TYPE1 2213194-1

D

C

B

A

4

4

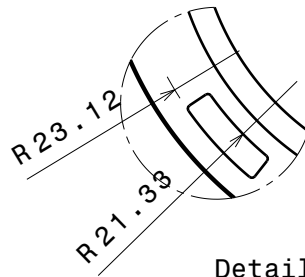
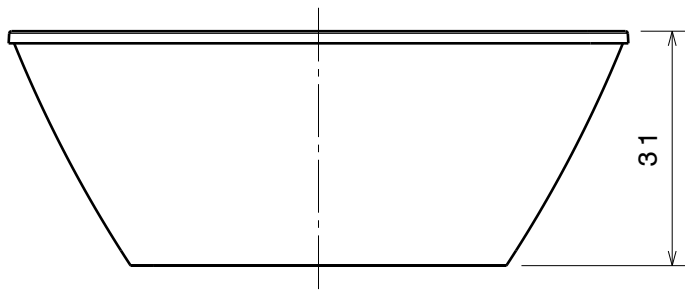

Detail B
Scale: 2:1

3

3

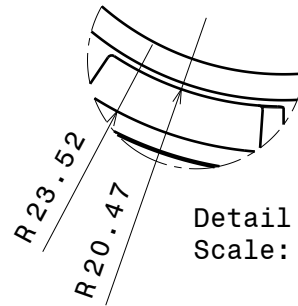
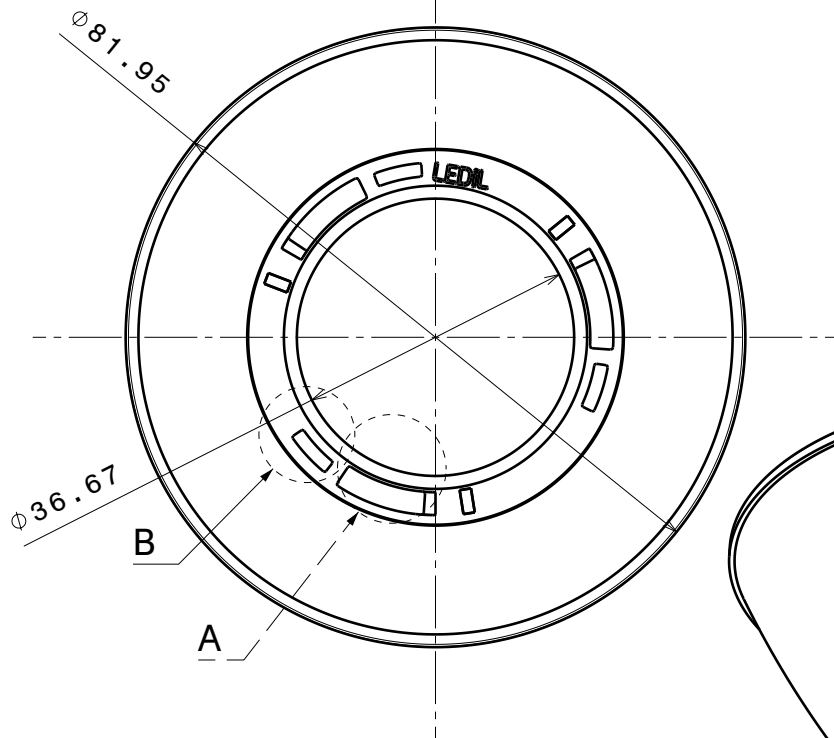

Detail A
Scale: 2:1

2

2

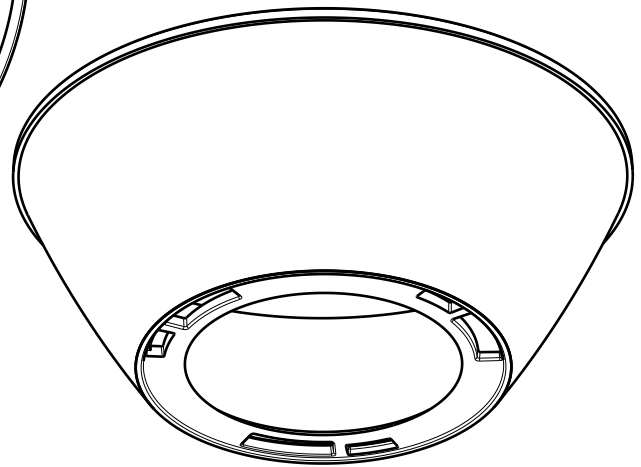

INDEX	PART NO	DESCRIPTION	MATERIAL	COLOUR
1		ANGELINA	PC	metal

Tolerances if not otherwise shown
According to DIN ISO 2768-1
Linear measures:
Up to 30mm class M, otherwise class C.
According to DIN ISO 2768-2
Form and position: class L

LEDiL
Ledil Oy
Salorankatu 10
FIN 24240 SALO
Finland

THIRD ANGLE PROJECTION:

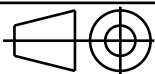

DRAWING TITLE

ANGELINA series Reflector

This drawing is the property of LEDiL Oy. It may not be reproduced, copied or communicated without a written agreement with LEDiL Oy."

SIZE PART NUMBER

A4

-

SCALE 1:1 WEIGHT

-

SHEET 1/1

D

A

1

Luminaire: LEDiL Oy F13325_ANGELINA-S (BXRA_ES) Eff.93.8%
Lamps: 1 x BXRA_ES_(BXRA-W1203_102820-3110)_281.549lm@250mA_P=4.09397W_I=249.8mA

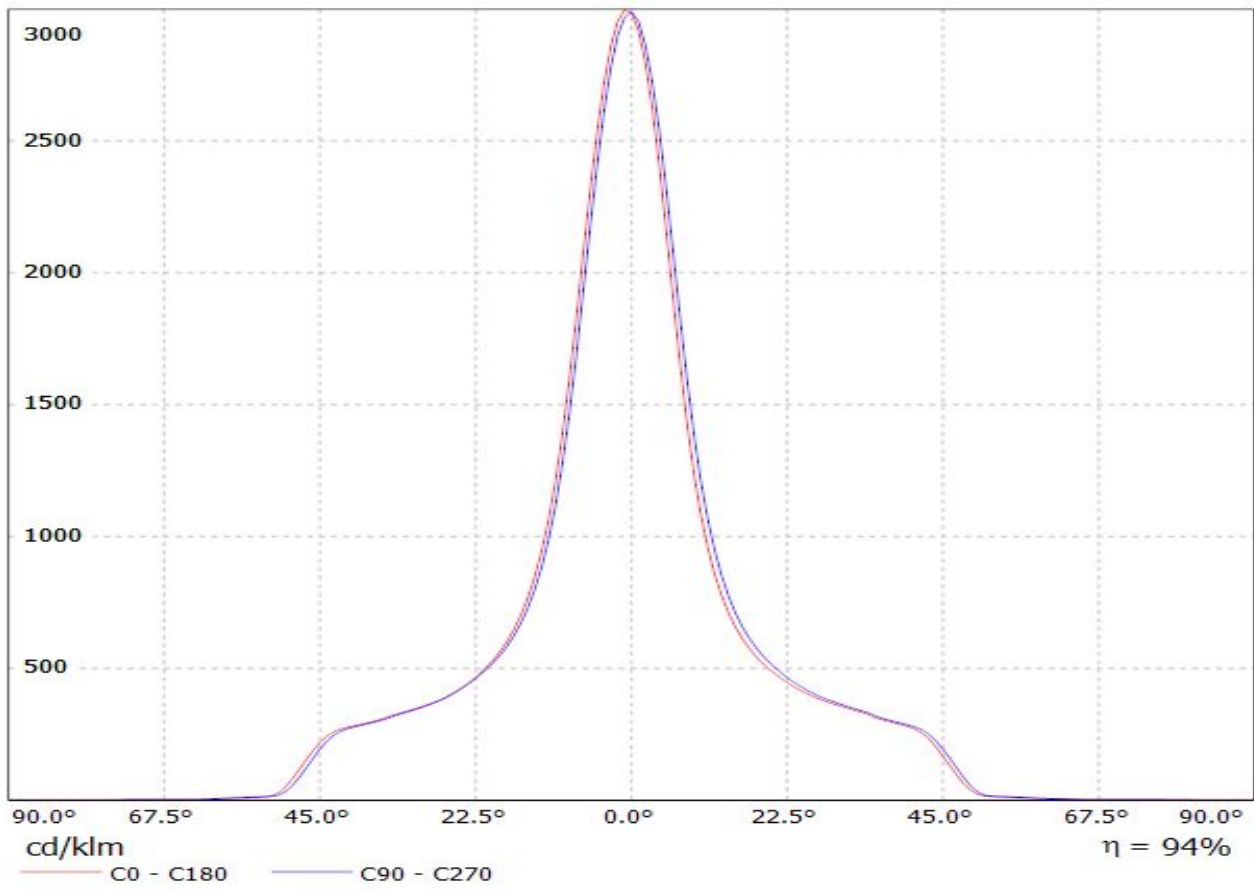

Luminaire: Ledil F13325_ANGELINA-S_(V22+IDEAL)
Lamps: 1 x Bridgelux_V22_(BXRE30E6500H-Y2)_+50-2204CT_+_50-2100AN_1193.54lm@250mA_CCT=3000K_P=8.0988W_I=0.25A

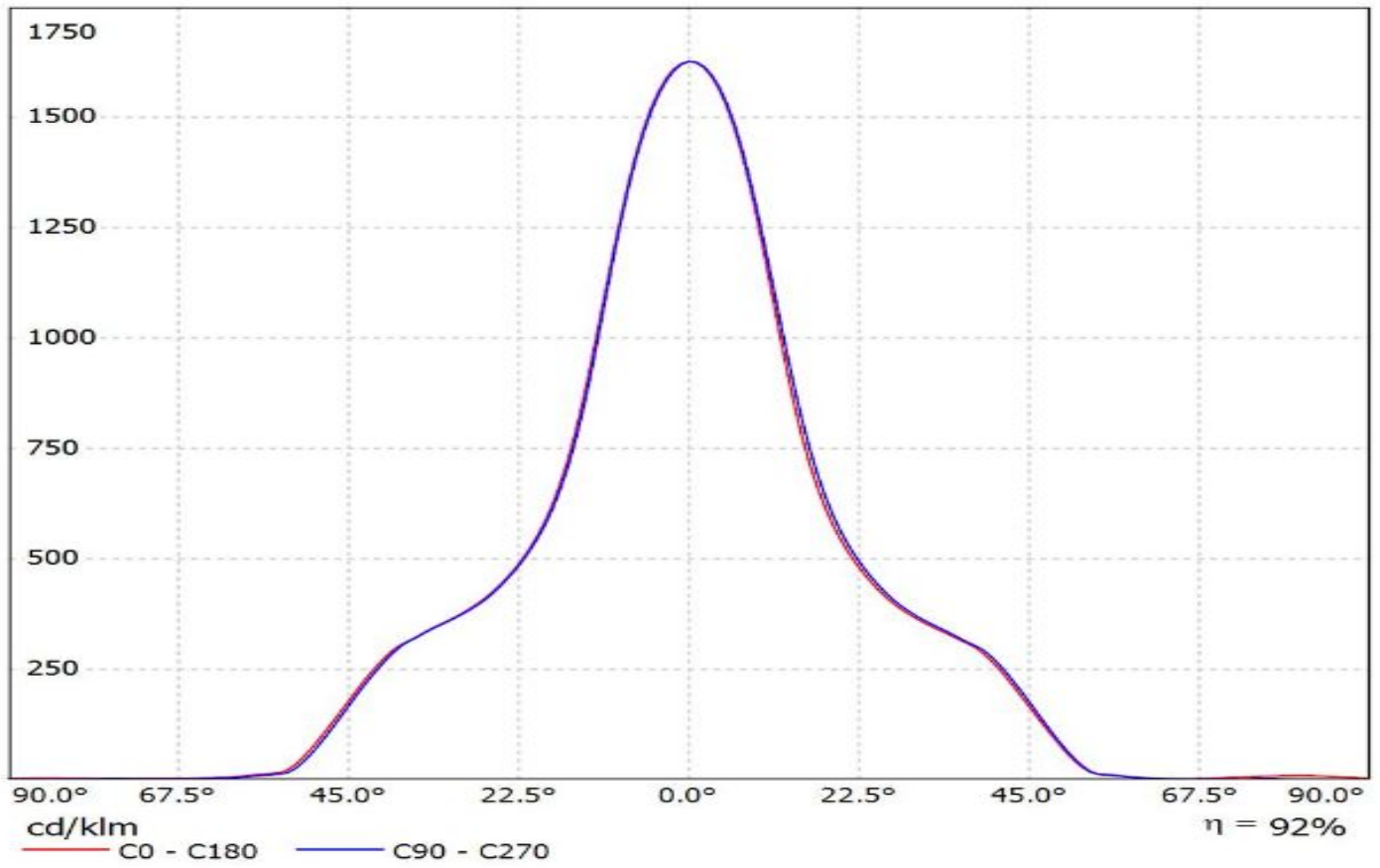

Luminaire: LEDiL Oy F13325_ANGELINA-S_(V13_Gen7)+TE

Lamps: 1 x Bridgelux_V13_Gen7_(BXRE-30E2000-B_+TE_2213254-2+TE_2213194-1)_1295.55lm@250mA_P=8.30985W_I=0.25A

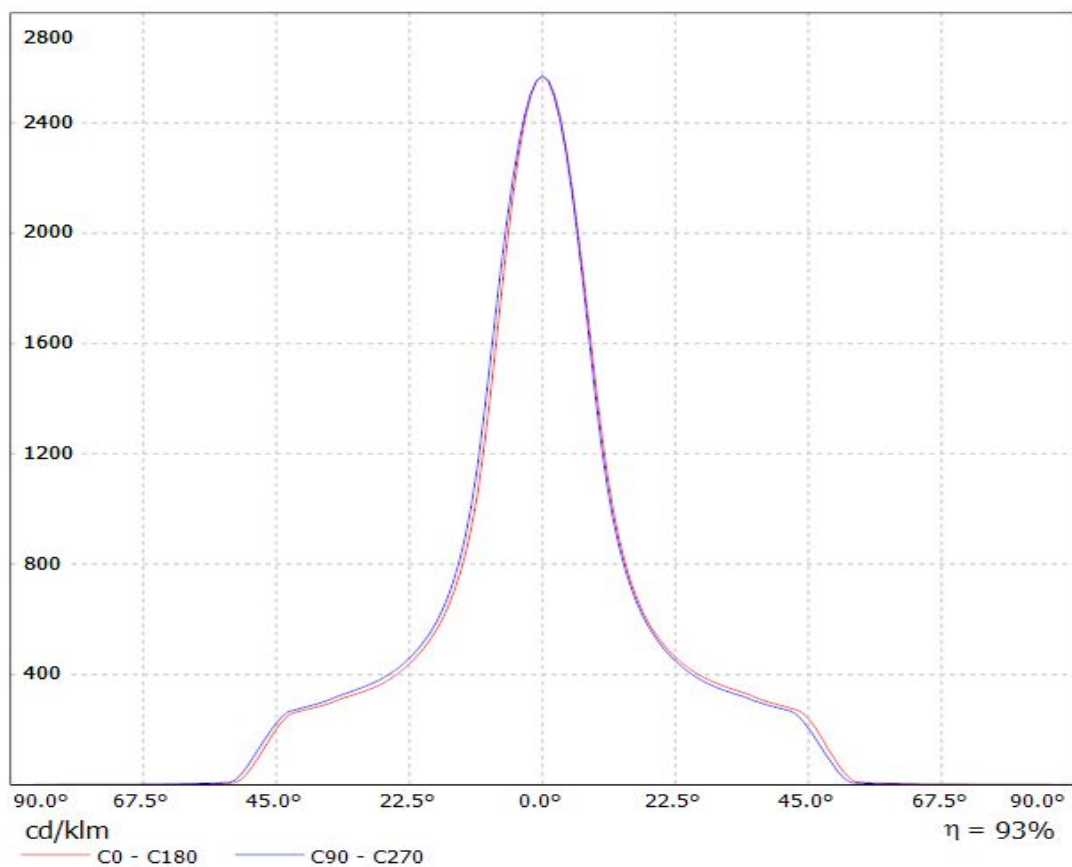

Luminaire: Ledil Oy F13325_ANGELINA-S_Bridgelux_V22_Gen7_SIMULATED F13325_ANGELINA-S_Bridgelux_V22_Gen7_SIMULATED
Lamps: 1 x F13325_ANGELINA-S_Bridgelux_V22_Gen7_SIMULATED

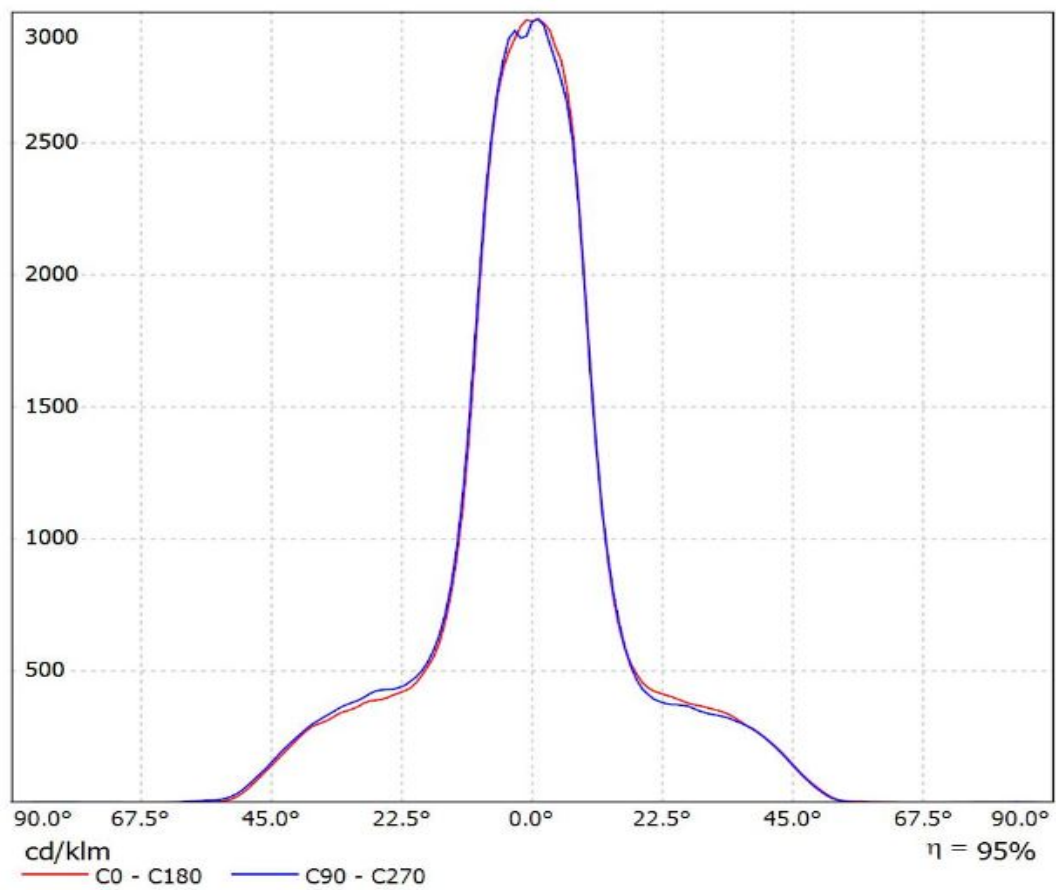

Luminaire: LEDiL Oy F13325_ANGELINA-S_(CLL030) Eff.93.6%

Lamps: 1 x CITIZEN_CLL030_(CLL030-1205A5-303H1A7)_758.588lm@250mA_CCT=5090K_P=8.61086W_I=249.8mA

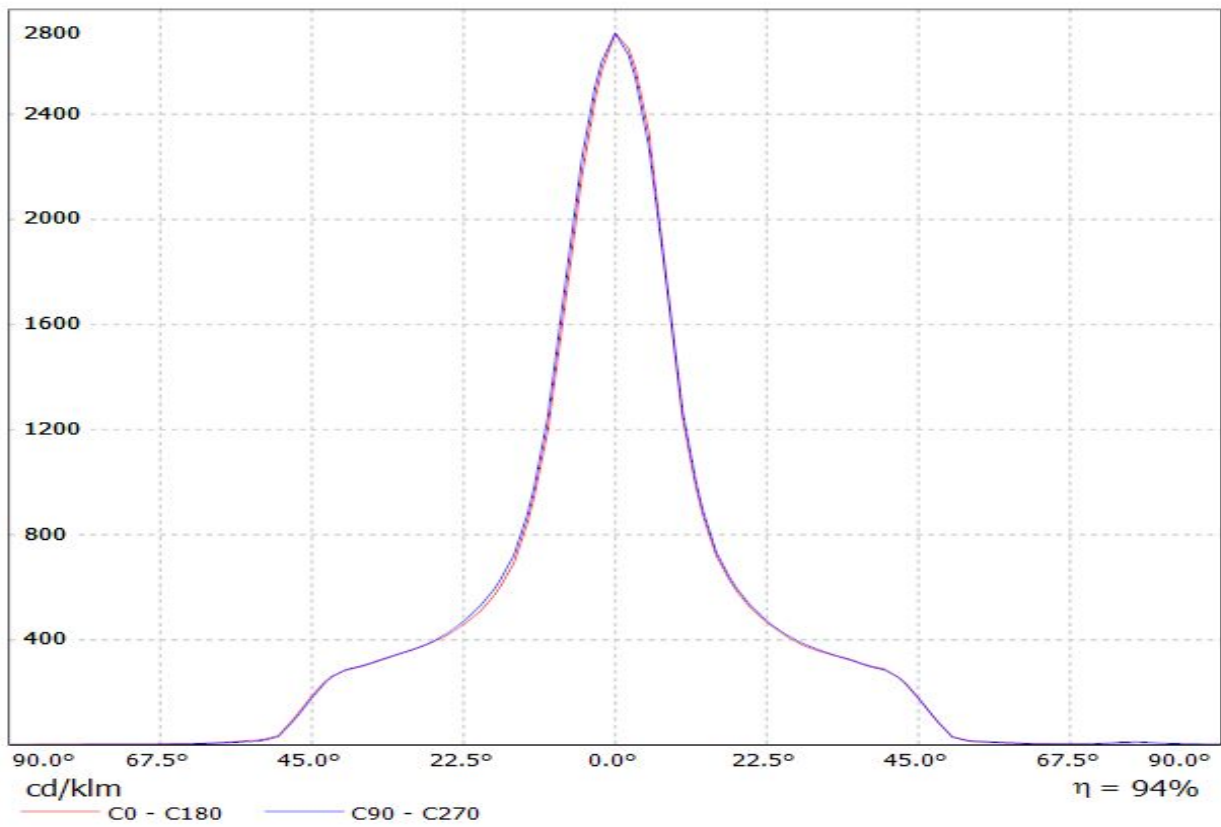

Luminaire: LEDiL F13325_ANGELINA-S_(CLL030)

Lamps: 1 x Citizen CLL030 740lm@250mA (CLL030-1205A5-303H1A7) CCT:3000K

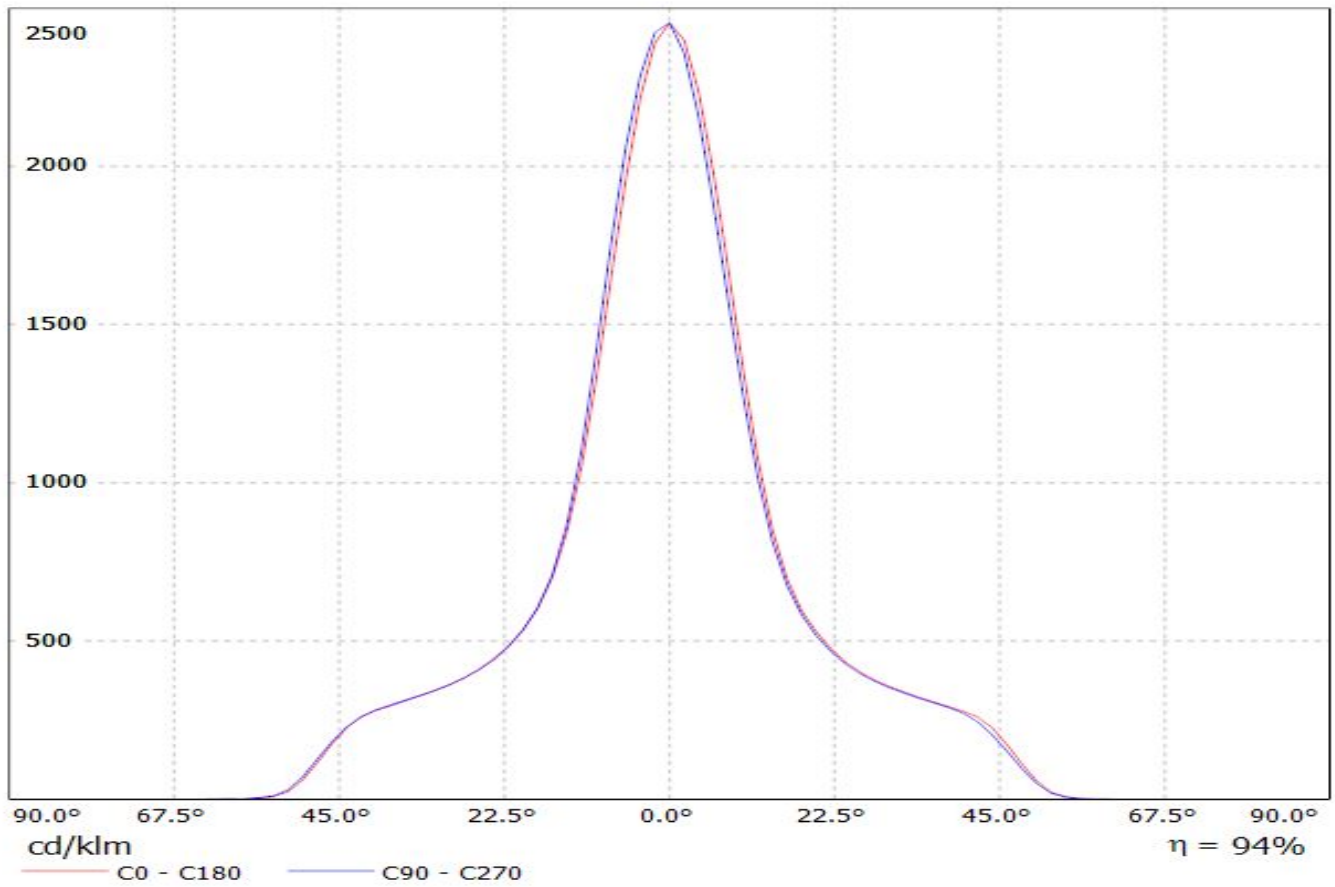

Ledil F13325_ANGELINA-S_(CLU720) / LDC (Linear)

Luminaire: Ledil F13325_ANGELINA-S_(CLU720)
Lamps: 1 x CITIZEN_CLU720_(CLU720-1206B8-273M2)
_1340.38lm@250mA_CCT=2700K_P=8.35W_I=0.25A

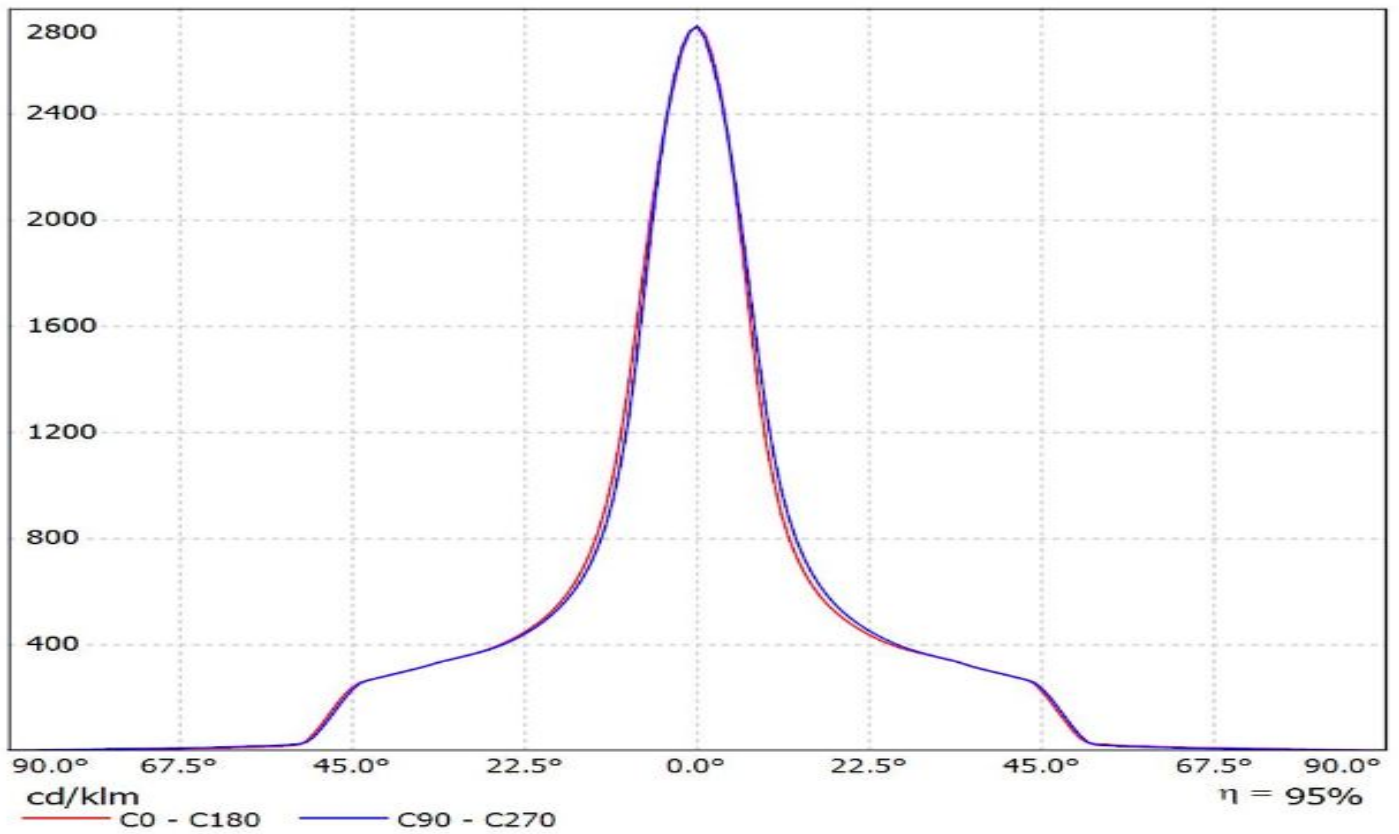

Luminaire: Ledil F13325_ANGELINA-S_(CLU720)
Lamps: 1 x CITIZEN_CLU720_(CLU720-1206B8-273M2)
_1337.27lm@250mA_CCT=2700K_P=8.35W_I=0.25A

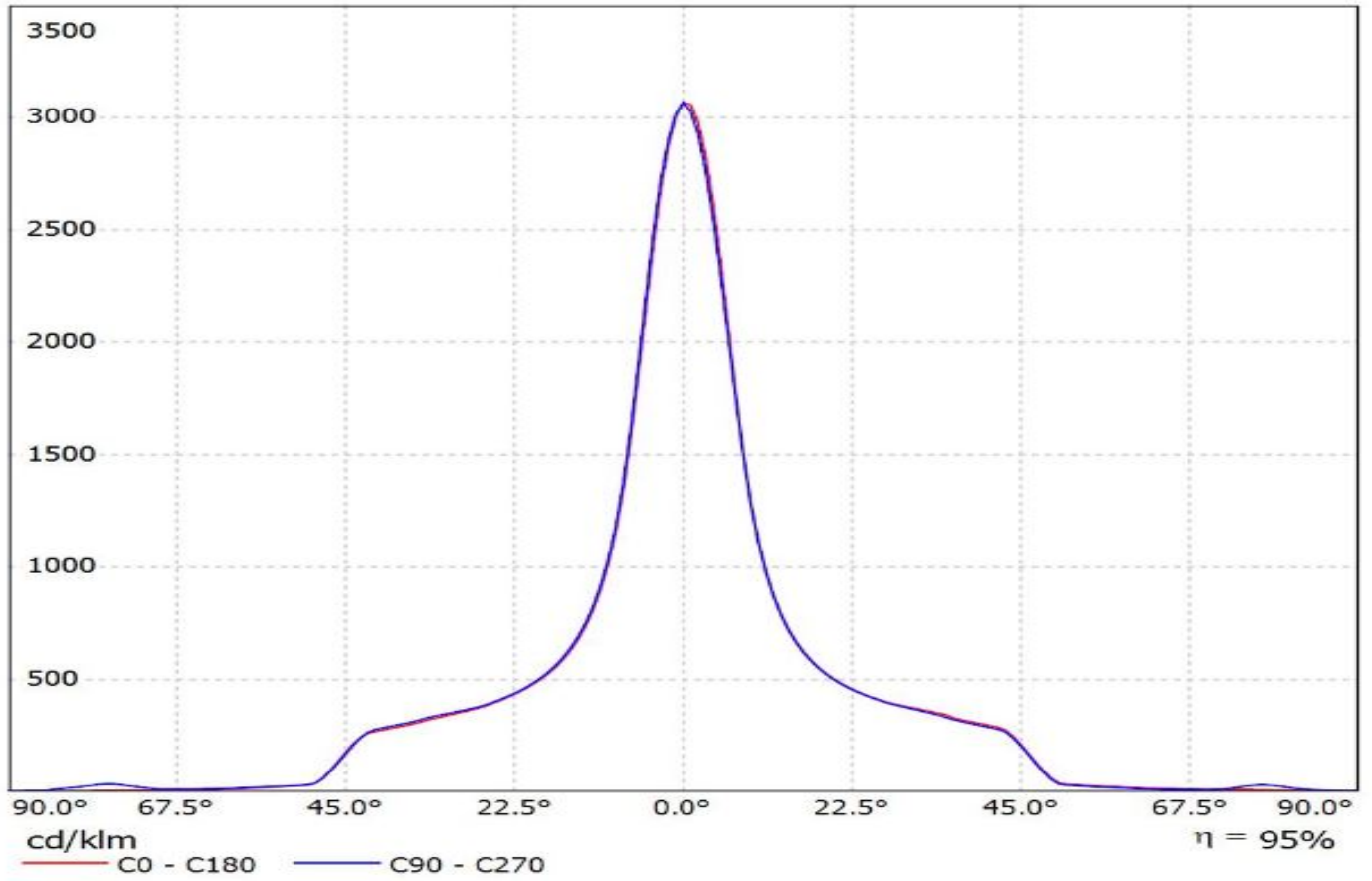

Luminaire: Ledil F13325_ANGELINA-S_(CLU046+IDEAL)

Lamps: 1 x Citizen_CLU046_(-1212C1-303M2G2)_1383.92lm@250mA_CCT=3000K_P=8.122W_I=0.25A

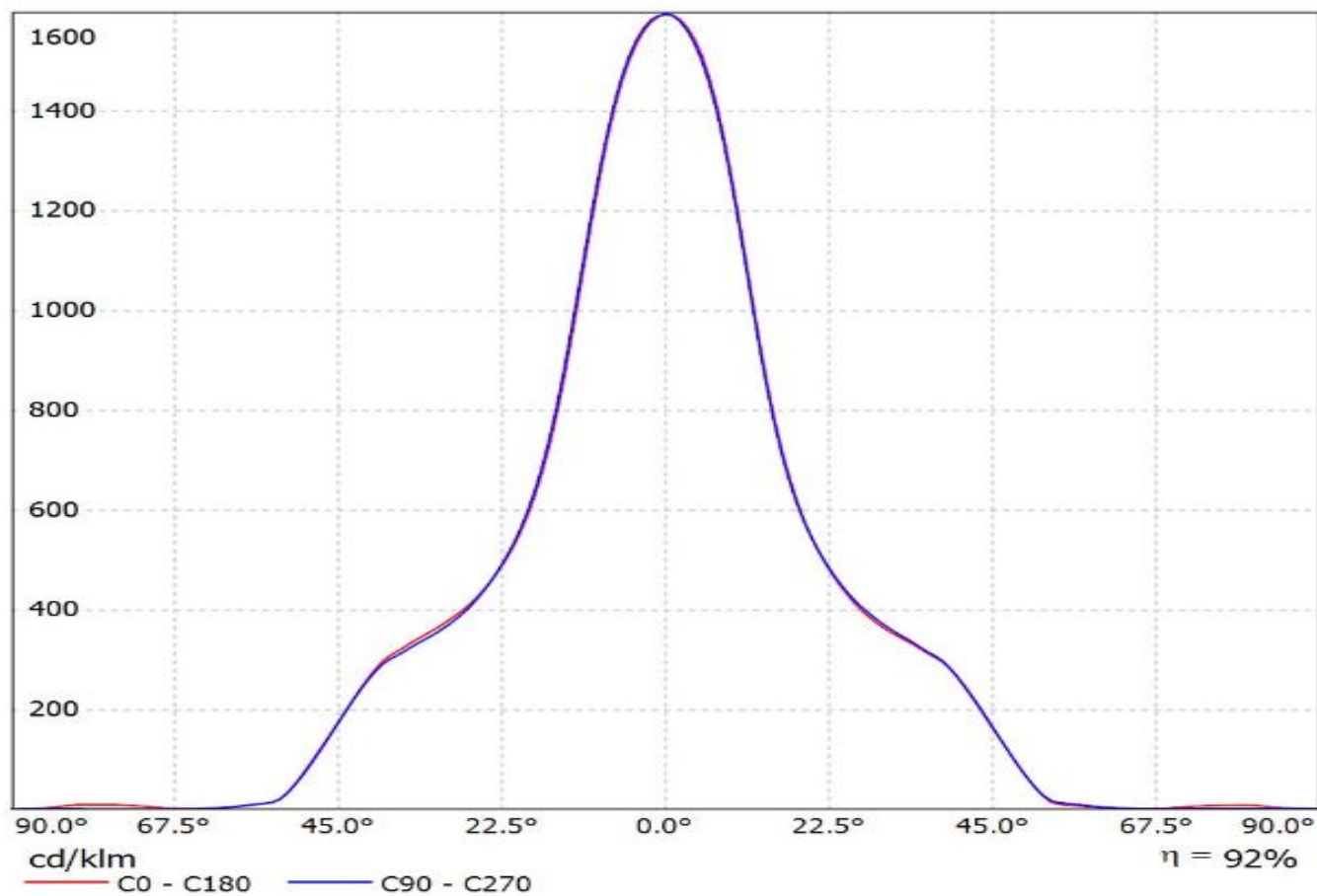

Luminaire: Ledil F13325_ANGELINA-S_(CLU730+IDEAL)

Lamps: 1 x Citizen_CLU730_(-1210B8-273M2G1)_IDEAL_50-2204C+50-2100AN

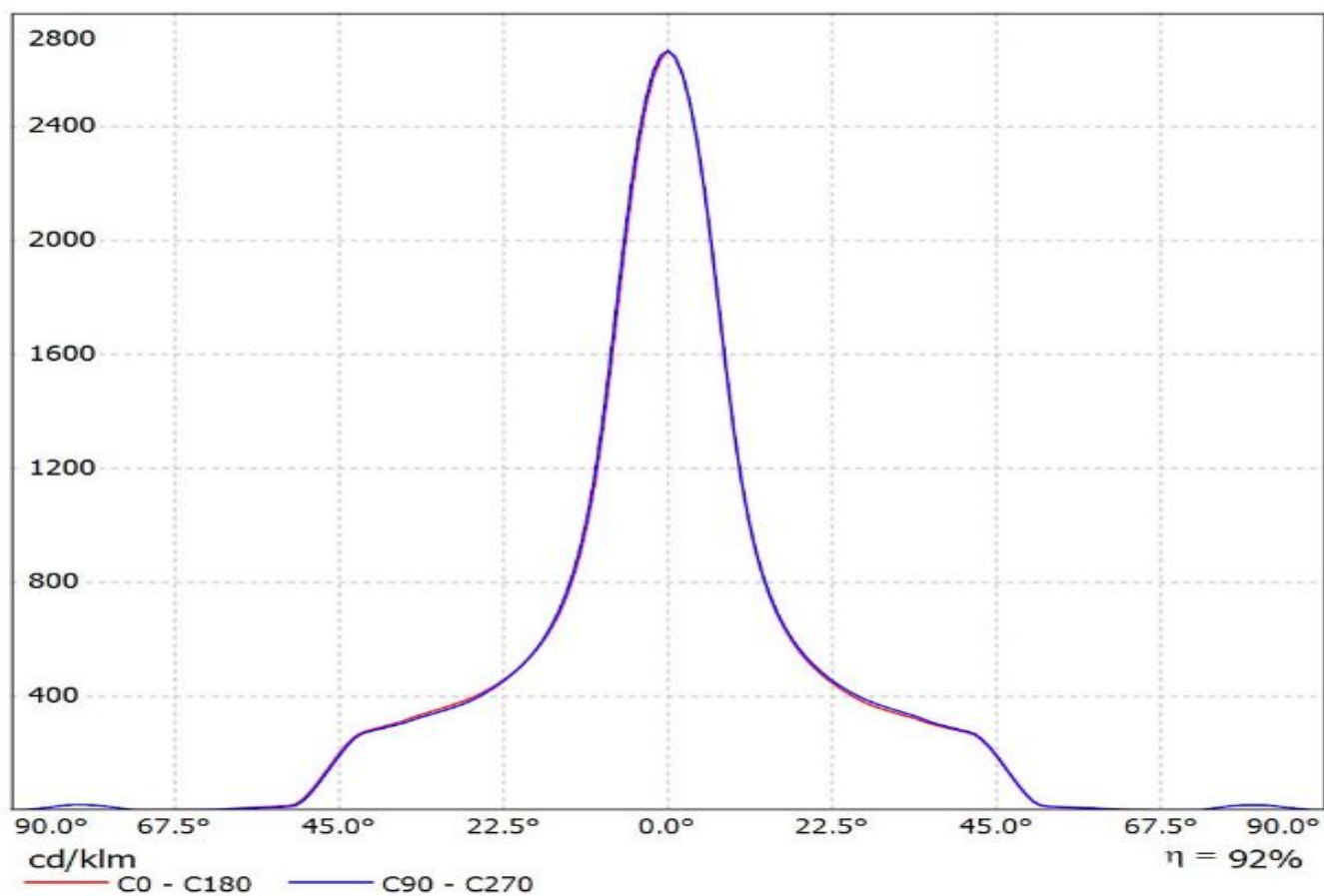

Luminaire: LEDiL Oy F13325_ANGELINA-S_(CXA30) Eff.94%

Lamps: 1 x CREE_CXA30_(CXA3050-3C0-Y2-N0H)_1340.66lm@250mA_P=8.16471W_CCT=5000K_I=249.8mA

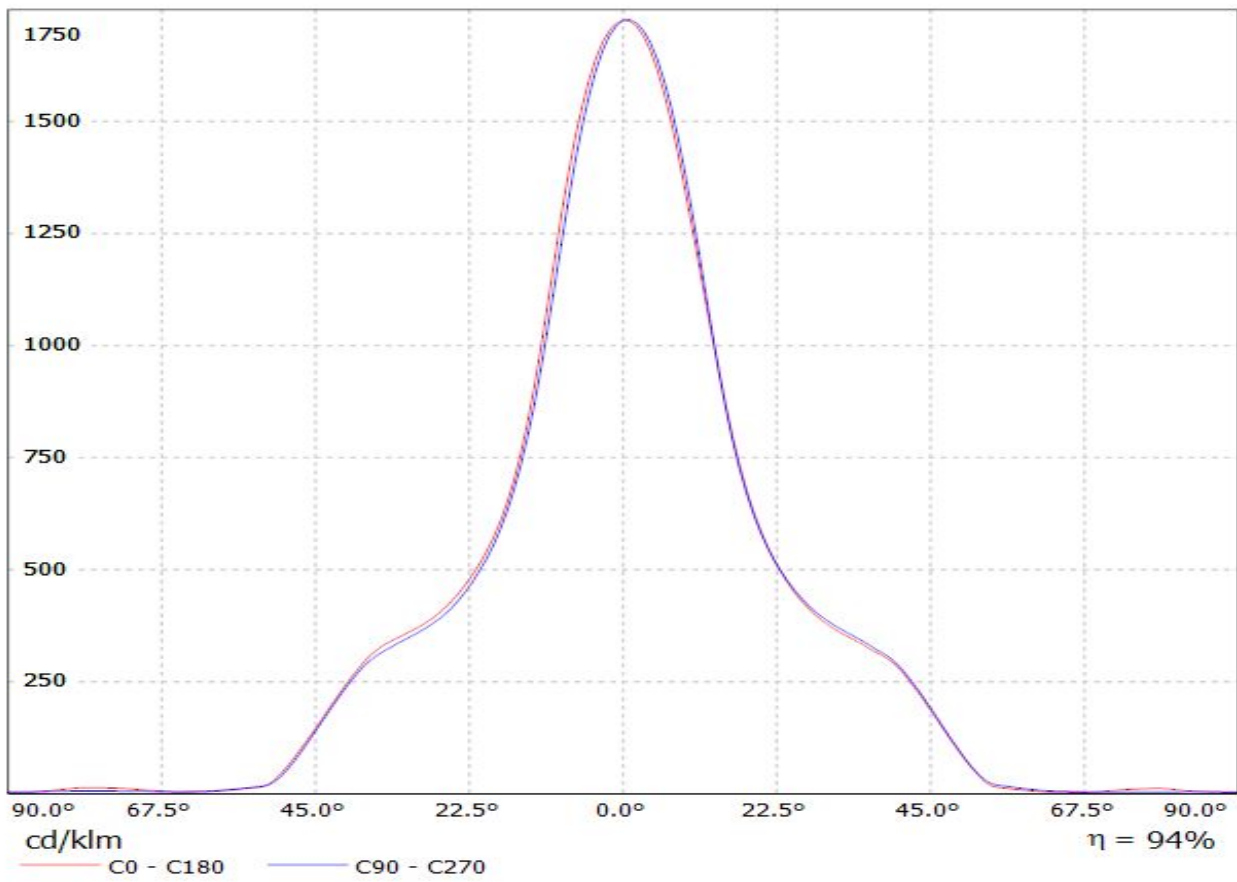

Luminaire: LEDiL Oy F13325_ANGELINA-S_(CXA25) Eff.94%
Lamps: 1 x CREE_CXA25_(CXA2530-7C0-T2-N0H)_1151.98lm@250mA_CCT=3000K_P=8.4892W_I=249.8mA

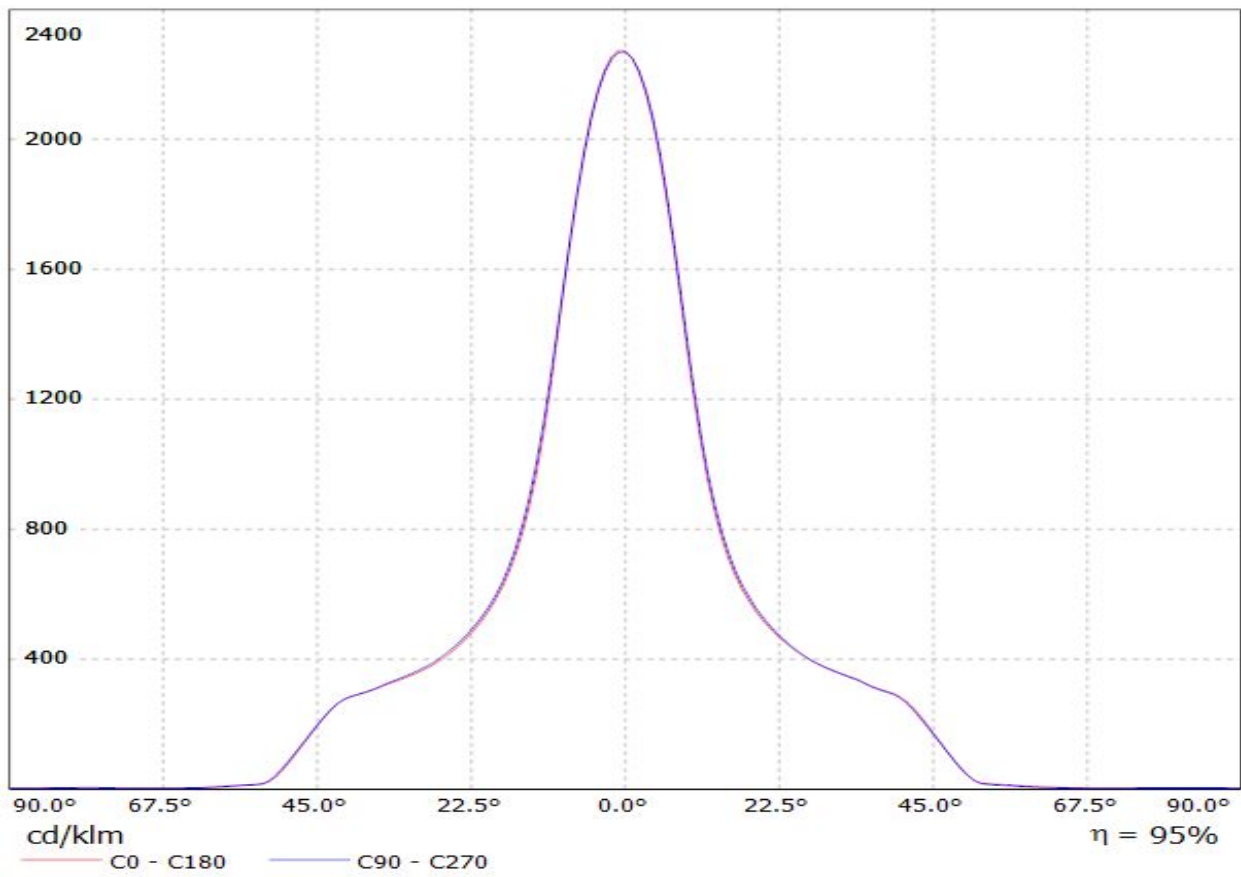

Luminaire: LEDiL Oy F13325_ANGELINA-S_(CXA1816) Eff. 94%
Lamps: 1 x CREE_CXA1816_1050lm@250mA_P=8.65157W_I=249.9mA

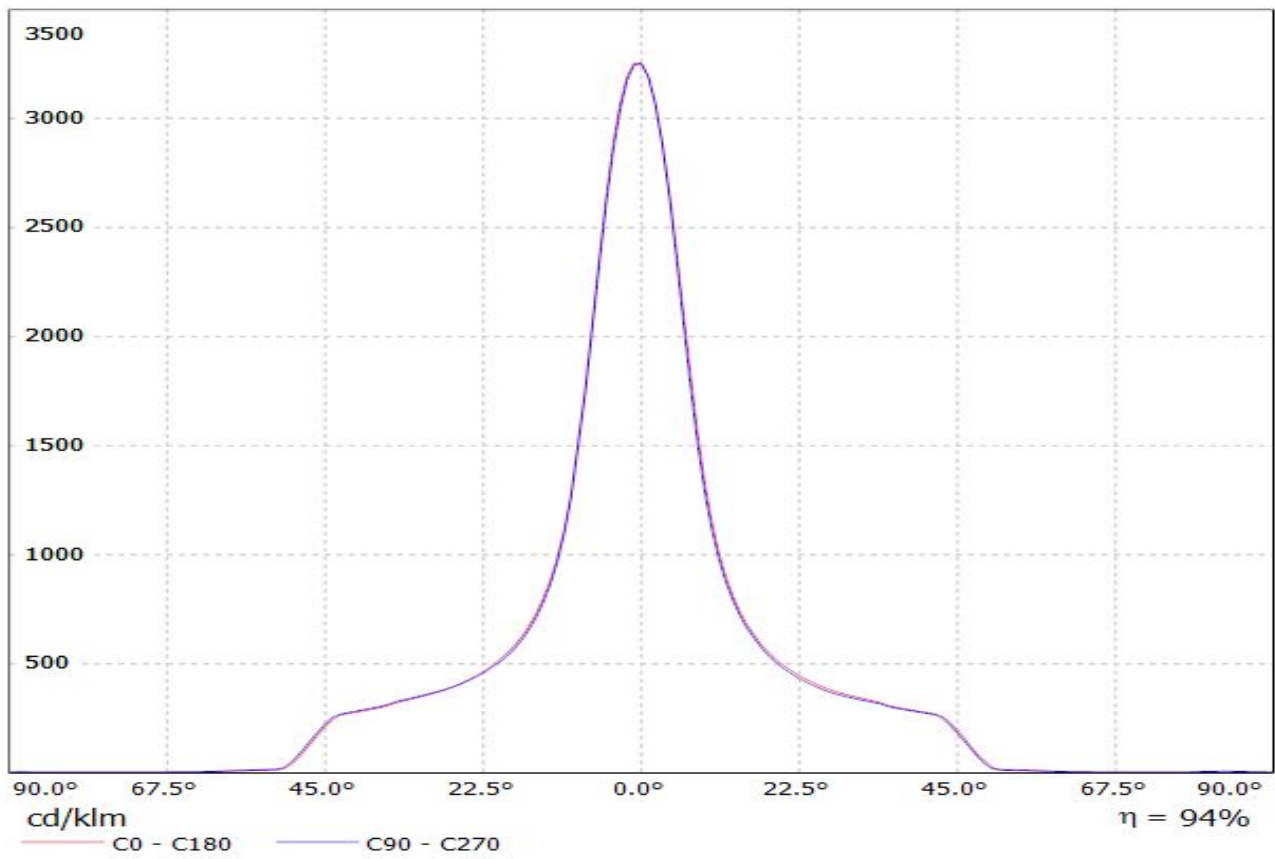

Luminaire: LEDiL Oy F13325_ANGELINA-S_(CXA3590)

Lamps: 1 x CREE_CXA3590_(CXA3590-30F-BD-R0H-0002)_2640.14lm@250mA_CCT=3000K_P=16.3941W_I=249.8mA

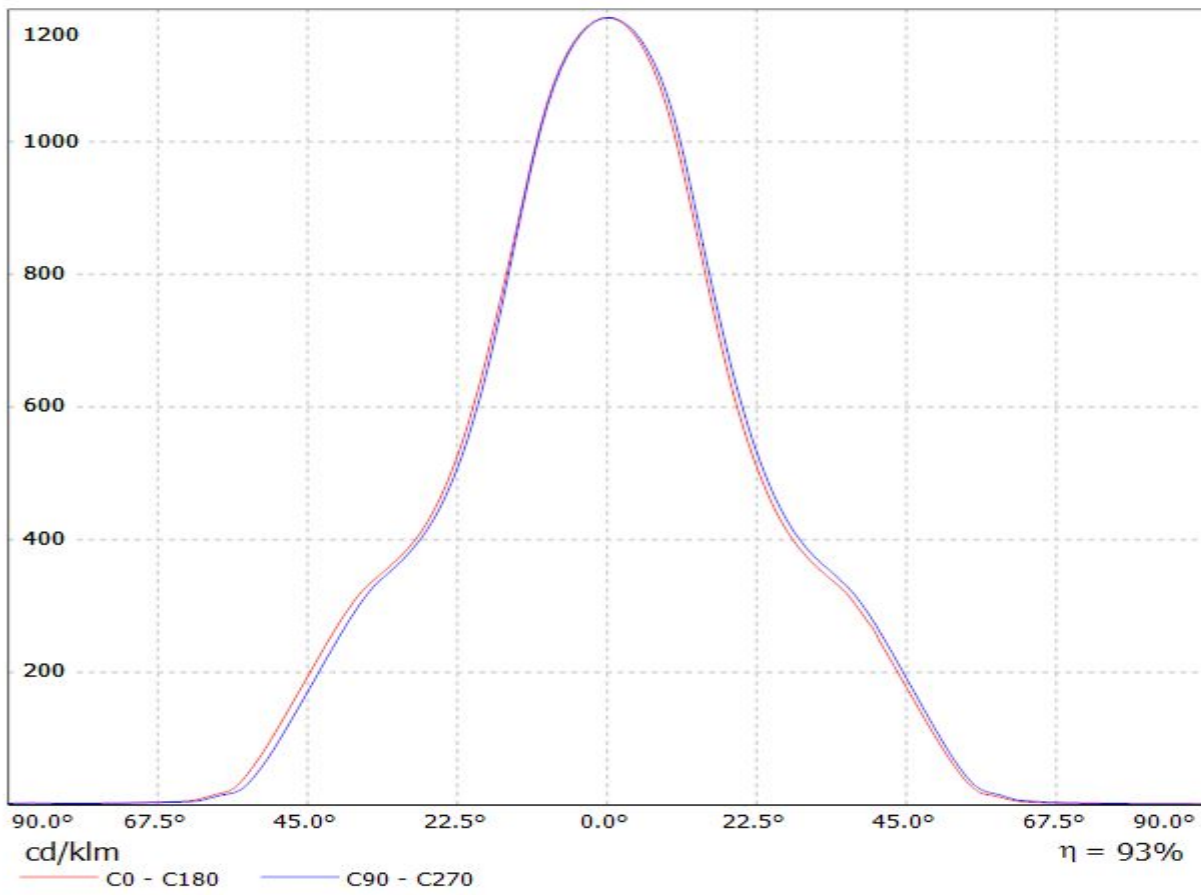

Luminaire: LEDiL Oy F13325_ANGELINA-S_(LG_COB-10W) Eff.93.9%
Lamps: 1 x LG_COB-10W_1024lm@250mA_CCT=5090K_P=9W_I=250mA

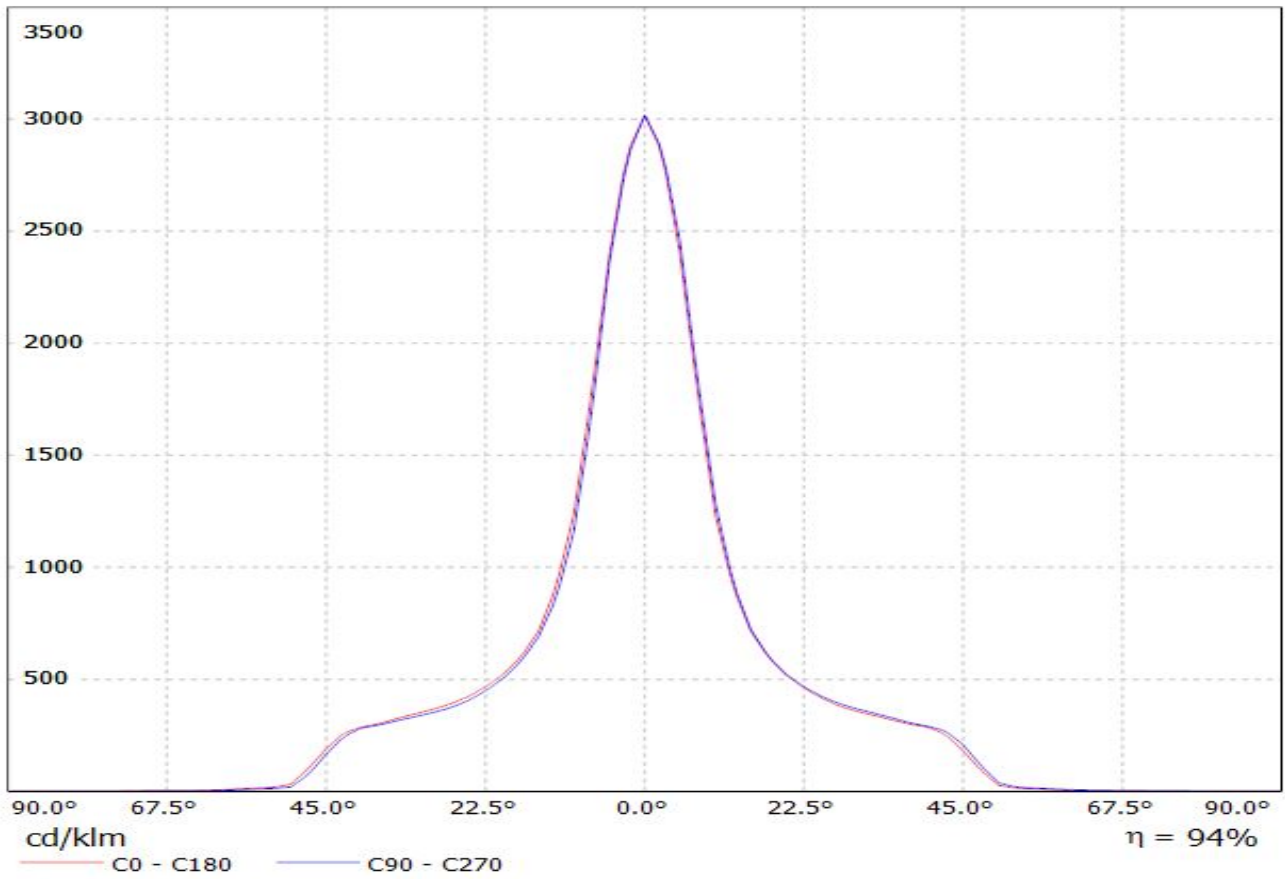

Luminaire: LEDiL Oy C13325_ANGELINA-S_(Luxeon_K16) Eff.94.2%
Lamps: 1 x LUXEON_K16 (1204.33lm@250mA)

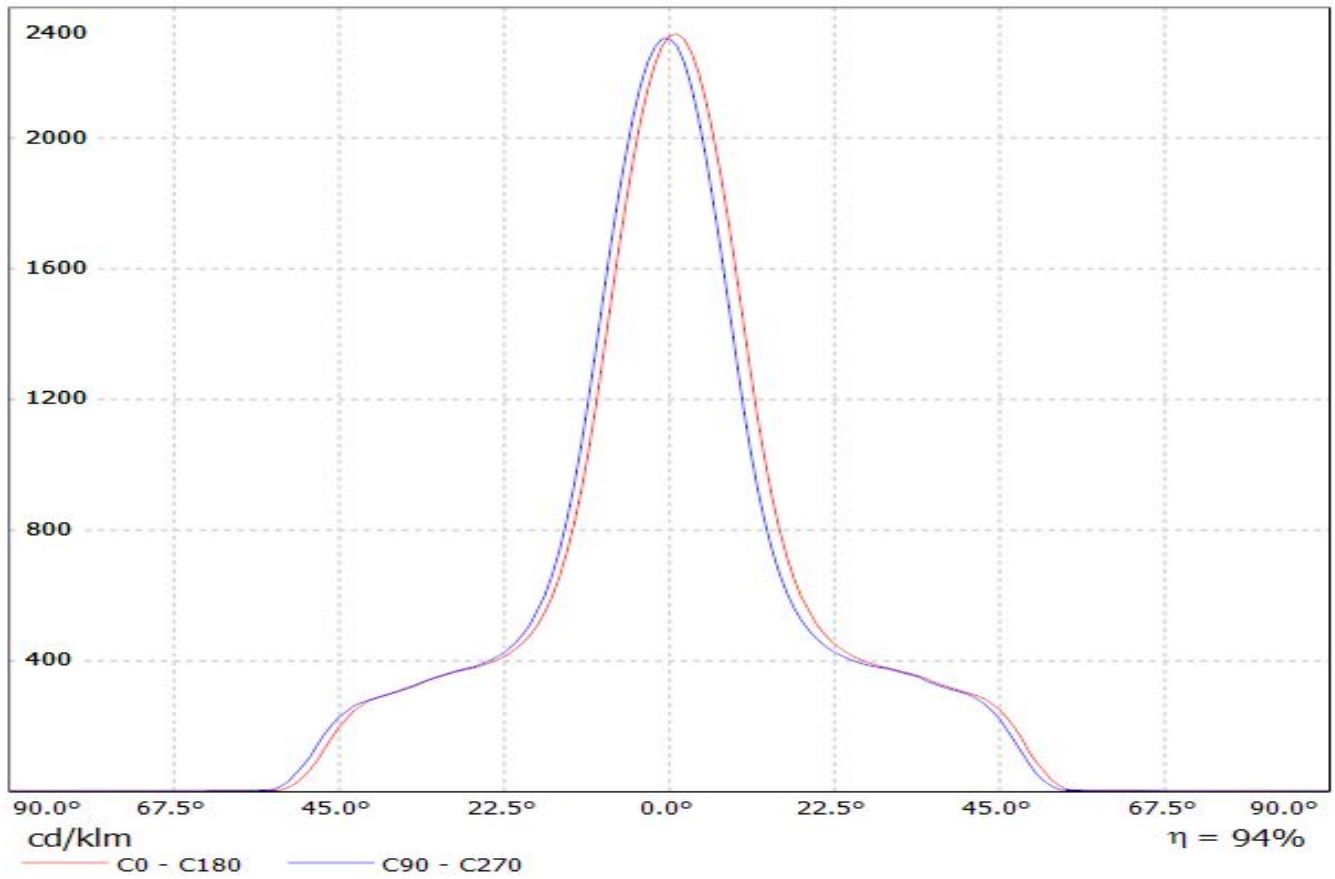

LEDiL Oy C13325_ANGELINA-S_(LUXEON_K12) Eff.94.3% / LDC (Linear)

Luminaire: LEDiL Oy C13325_ANGELINA-S_(LUXEON_K12) Eff.94.3%
Lamps: 1 x LUXEON_K12 (929.543lm@250mA)

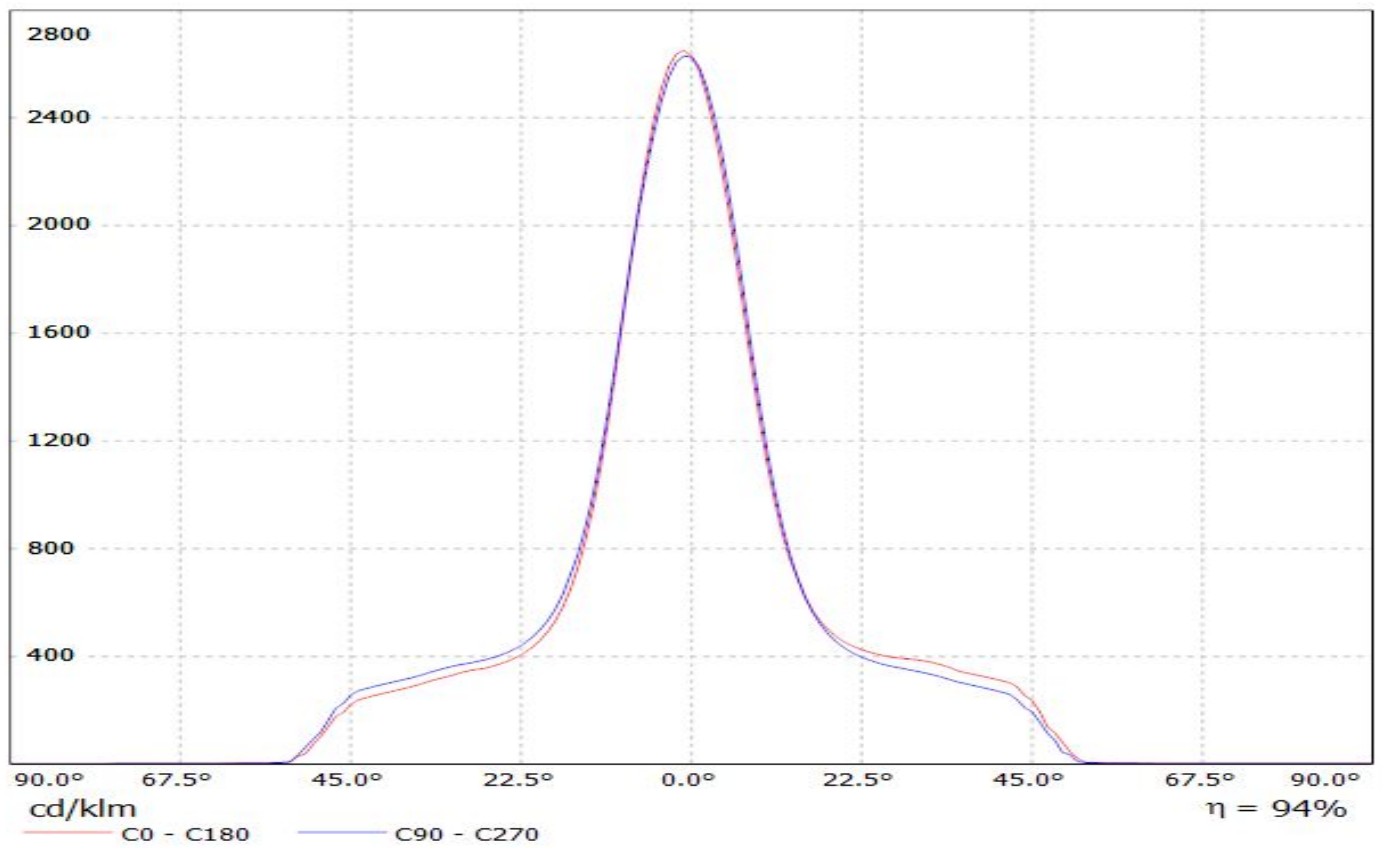

Luminaire: LEDiL Oy F13325_ANGELINA-S_(LUXEON CoB 1205) Eff: 94 %
Lamps: 1 x LUXEON CoB 1205 (LHC1-3080-1205) 1082lm@250mA CCT=3000K P=8.3W I=250mA

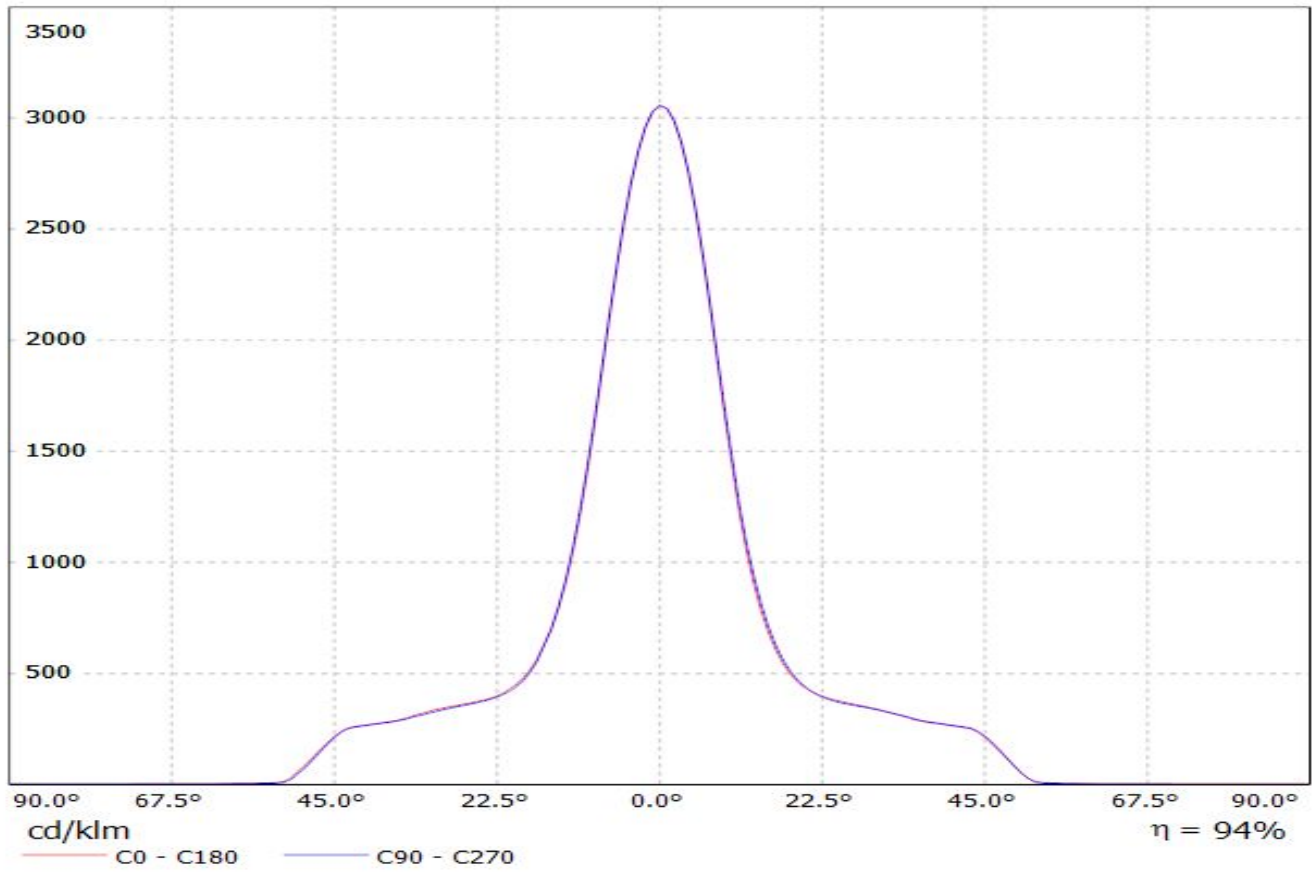

Luminaire: LEDiL Oy F13325_ANGELINA-S_(Luxeon-Cob-1208) Eff: 93 %
Lamps: 1 x Luxeon CoB 1208 (LHC1-3080-1208) 1029lm@250mA CCT=3000K P=8.2W I=250mA

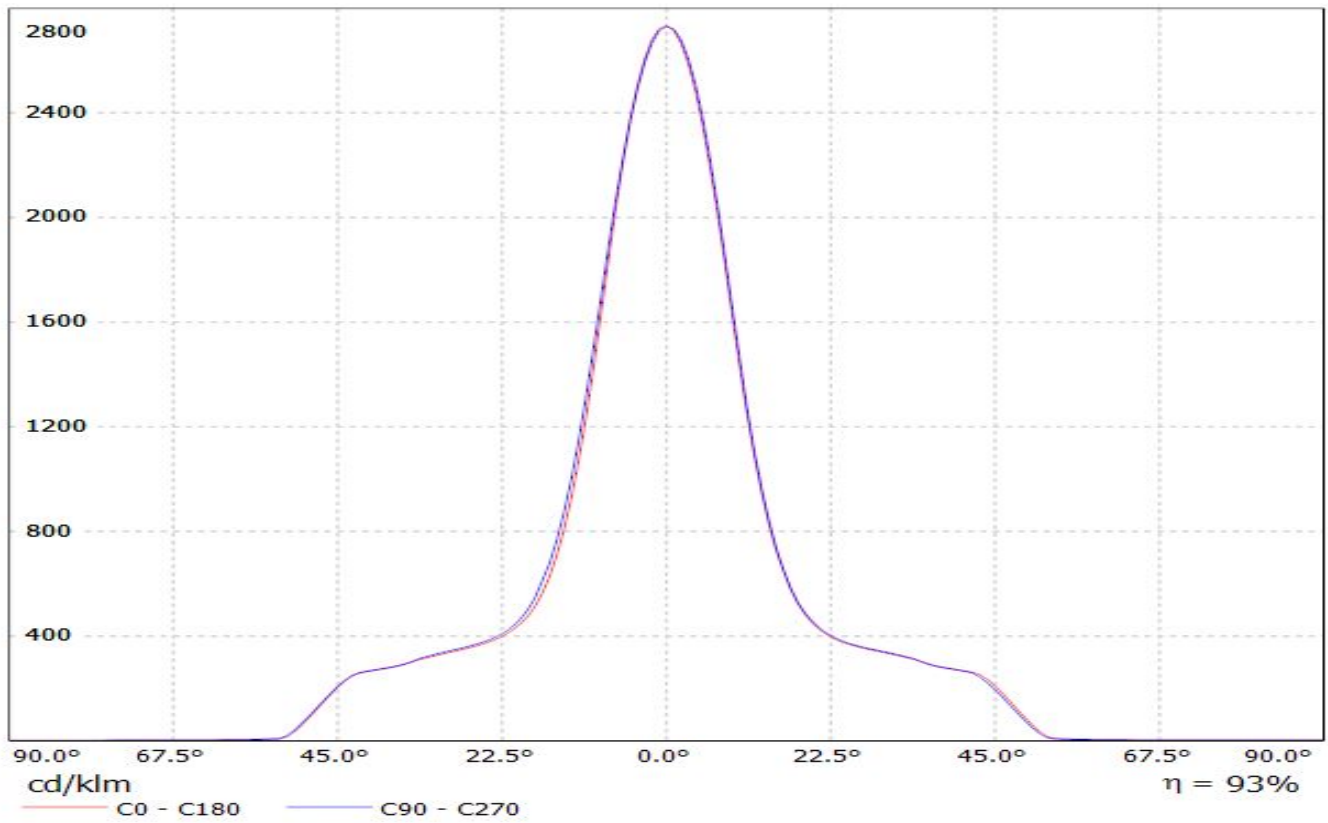

Luminaire: LEDiL Oy F13325_ANGELINA-S_(LUXEON_COB_1205) Eff.93.8%
Lamps: 1 x LUXEON_COB_1205_(LHC1-3080-1205)_1084.49lm@250mA_CCT=3000K_P=8.31784W_I=249.8mA

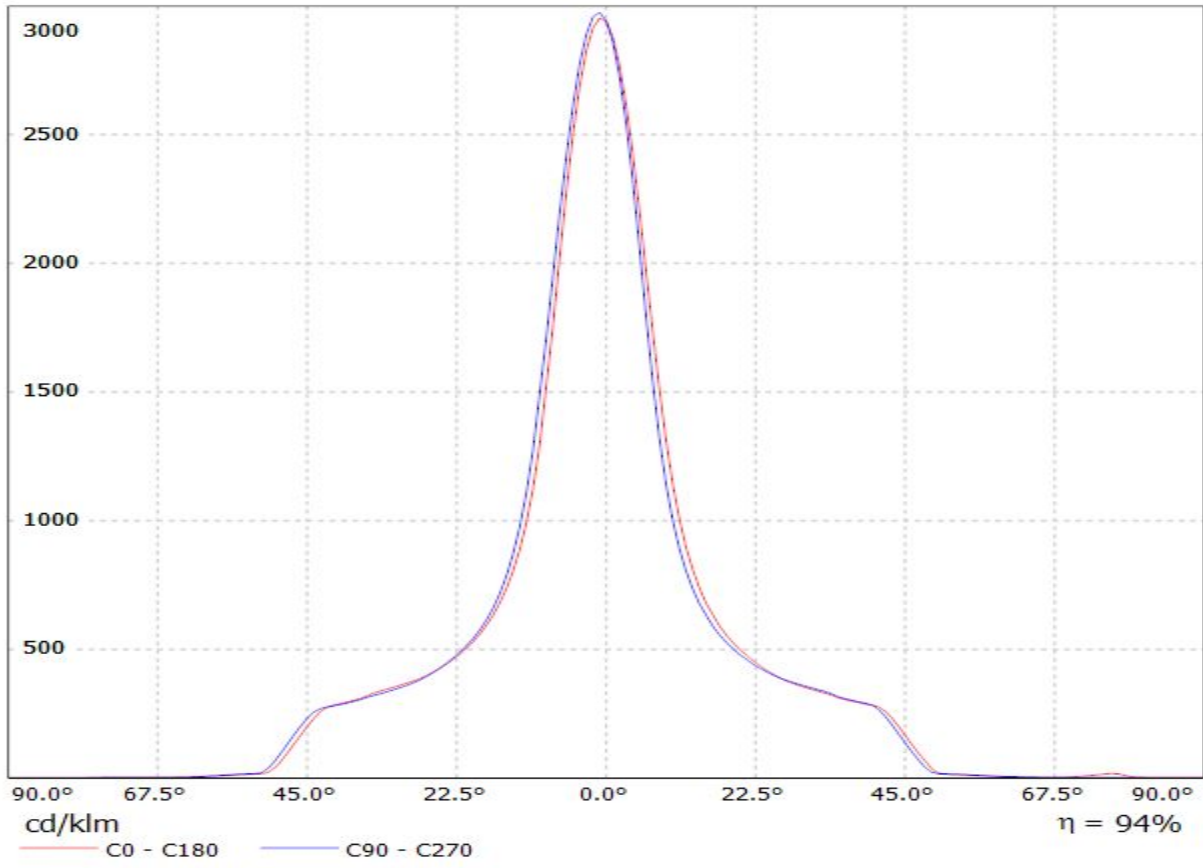

Luminaire: LEDiL Oy F13325_ANGELINA-S (LUXEON_COB_1208) Eff.93.8%
Lamps: 1 x LUXEON_COB_1208_(LHC1-3080-1208)_1015.13lm@250mA_CCT=3000K_P=8.15972W_I=249.8mA

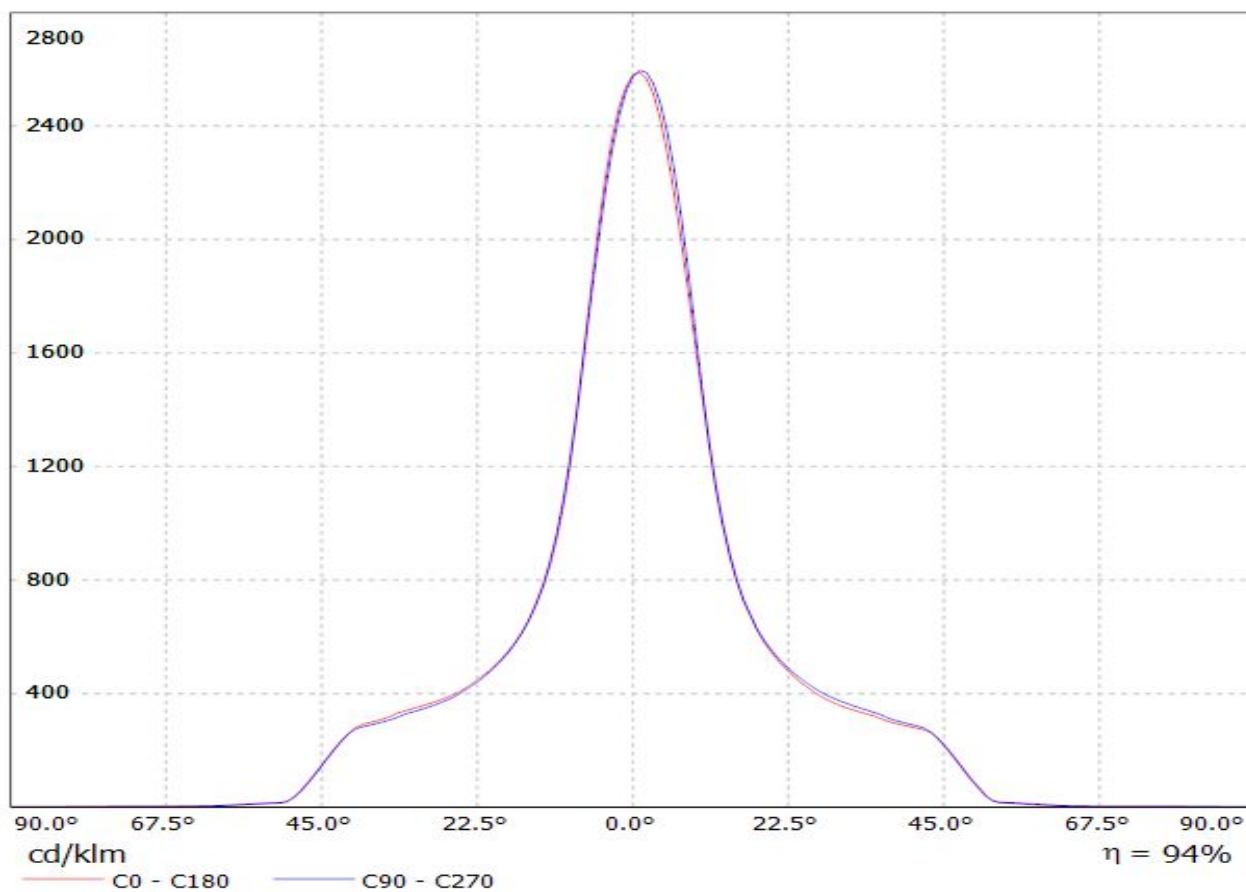

Luminaire: Ledil F13325_ANGELINA-S_(CoB1211+IDEAL)
Lamps: 1 x Luxeon_CoB1211_(L2C2-4080)_50-2204CT+50-
2100AN_1376.18lm@250mA_P=7.9988W_I=0.25A

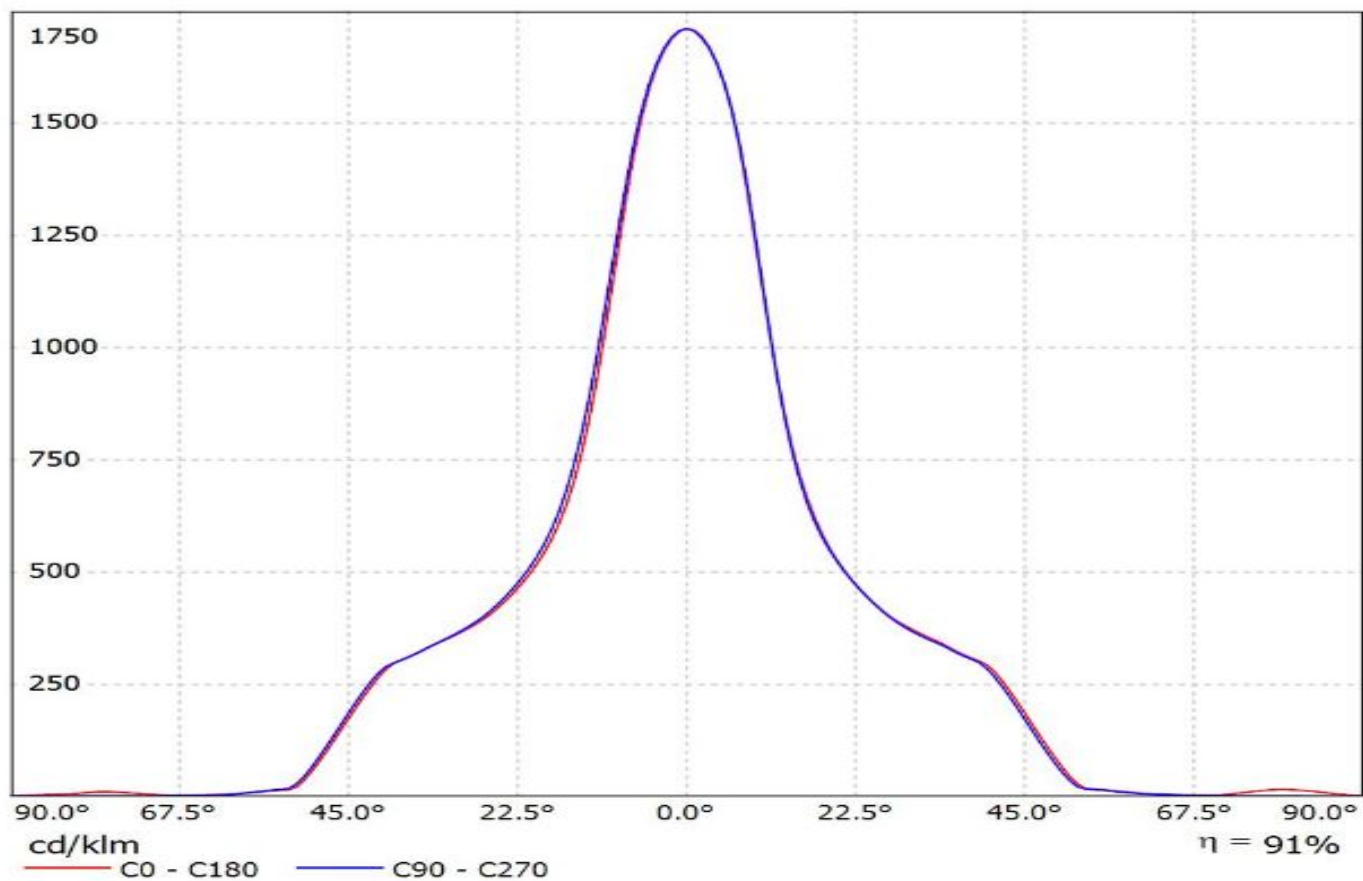

Luminaire: LEDiL Oy F13325_ANGELINA-S_(CXM-14)
Lamps: 1 x LUMINUS_CXM-14_1114.36lm@250mA_P=8.36106W_I=249.8mA

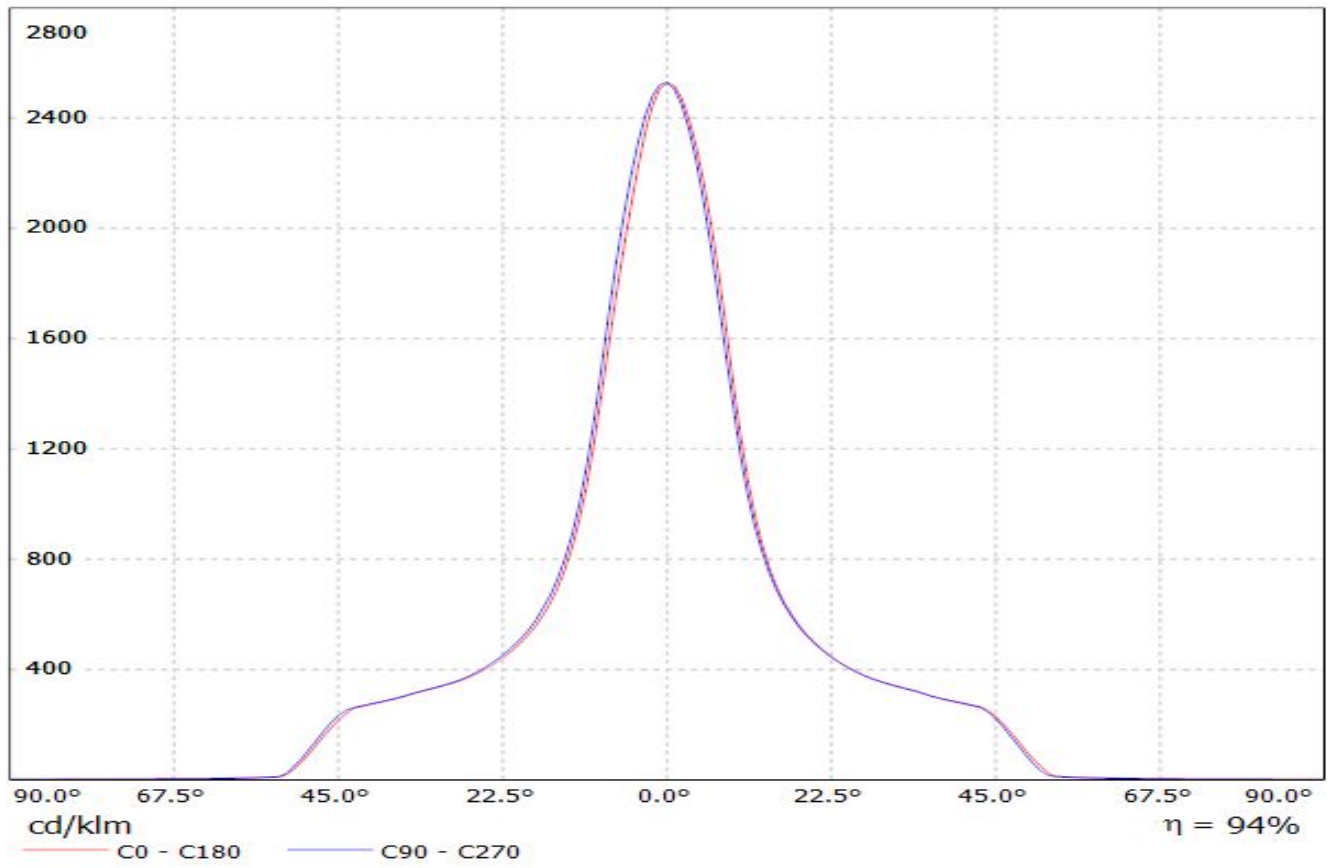

Luminaire: LEDiL Oy F13325_ANGELINA-S_(NSBxL121A) Eff.91.2%
Lamps: 1 x NICHIA_NSBxL121A_(NSBLL121AE)_805.561lm@250mA_CCT=3000K_P=7.3681W_I=249.8mA

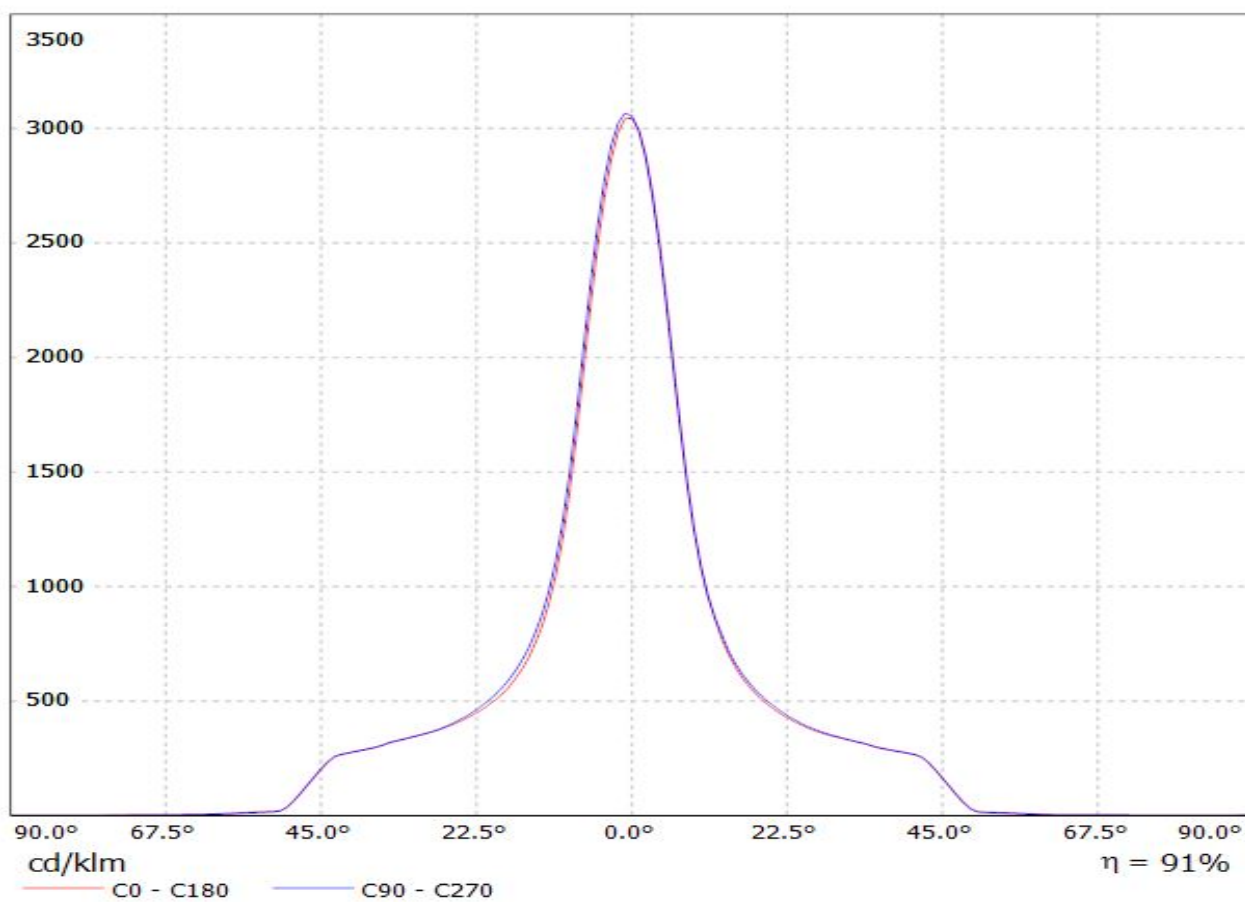

Luminaire: LEDiL Oy F13325_ANGELINA-S_(NSCxJ216A) Eff.94.0%
Lamps: 1 x NICHIA_NSCxJ216A_(NSCLJ216AE)_971.7lm@250mA_CCT=3000K_P=7.96937W_I=249.8mA

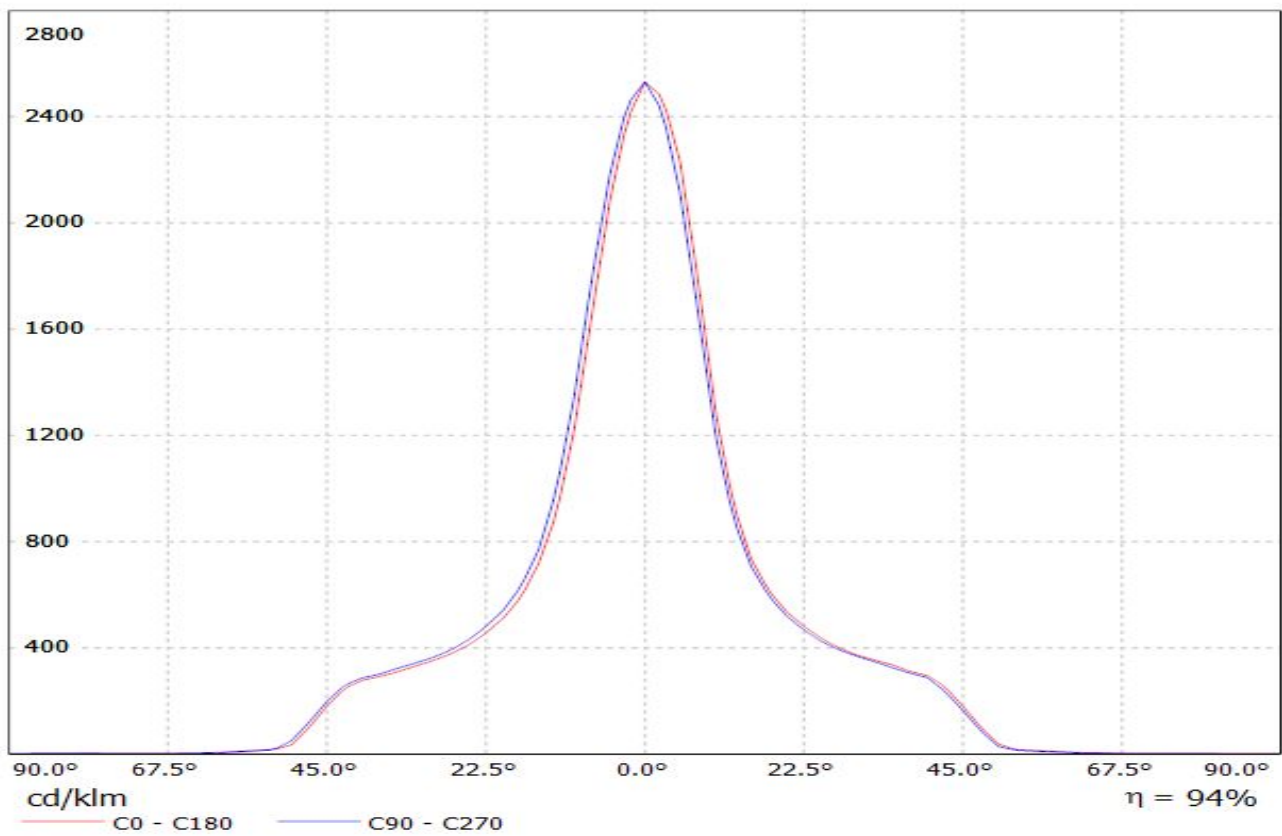

Luminaire: LEDiL Oy F13325_ANGELINA-S_(NSBxL121A)

Lamps: 1 x Nichia_NSBxL121A_914.478lm@250mA_P=7.56872W_I=249.9mA

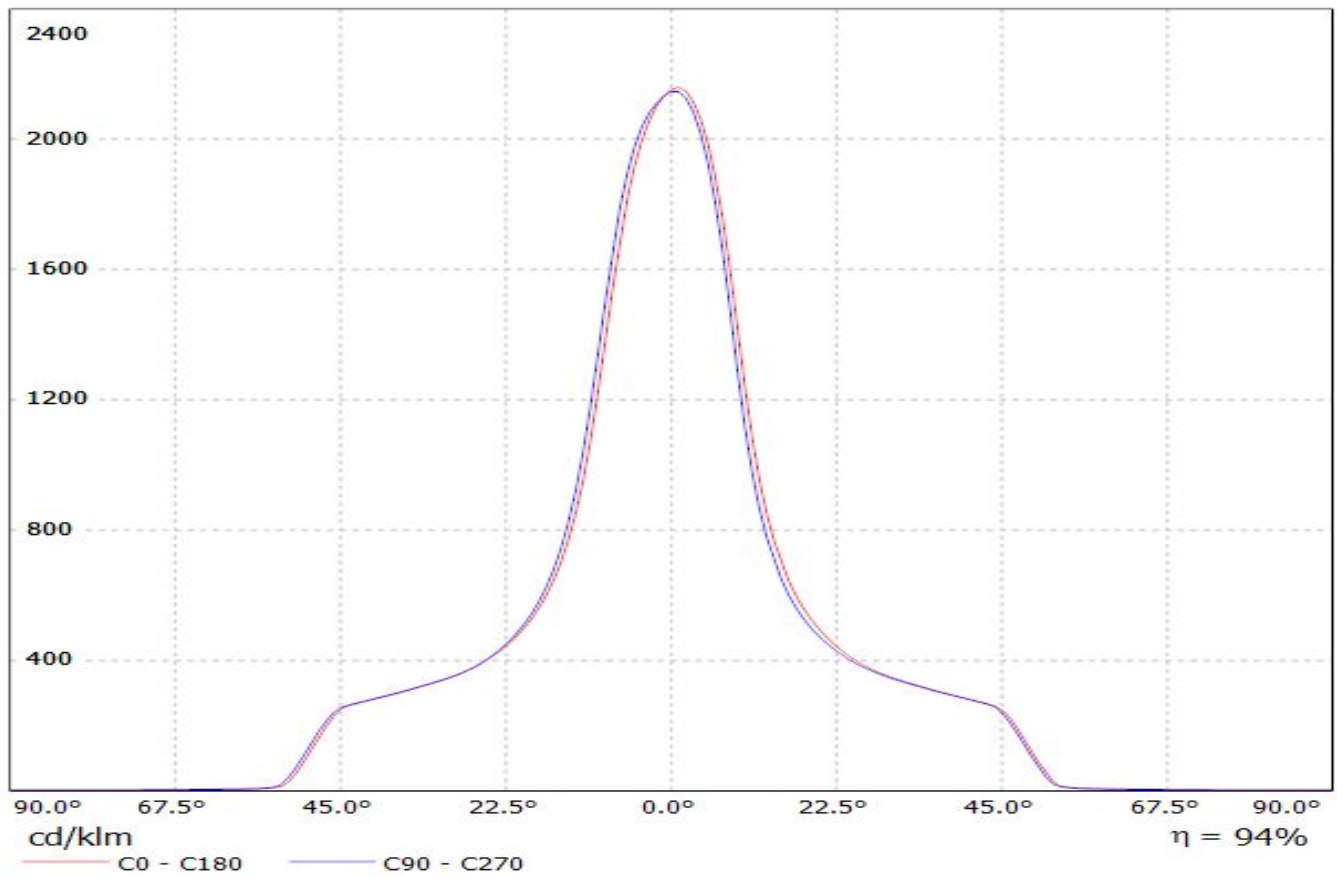

Luminaire: Ledil F13325_ANGELINA-S_(NVCLL024Z+TE)

Lamps: 1 x Nichia_NVCLL024Z_+2213382-2_+2213194-1_971.485lm@250mA_CCT=3000K_P=8W_I=0.25A

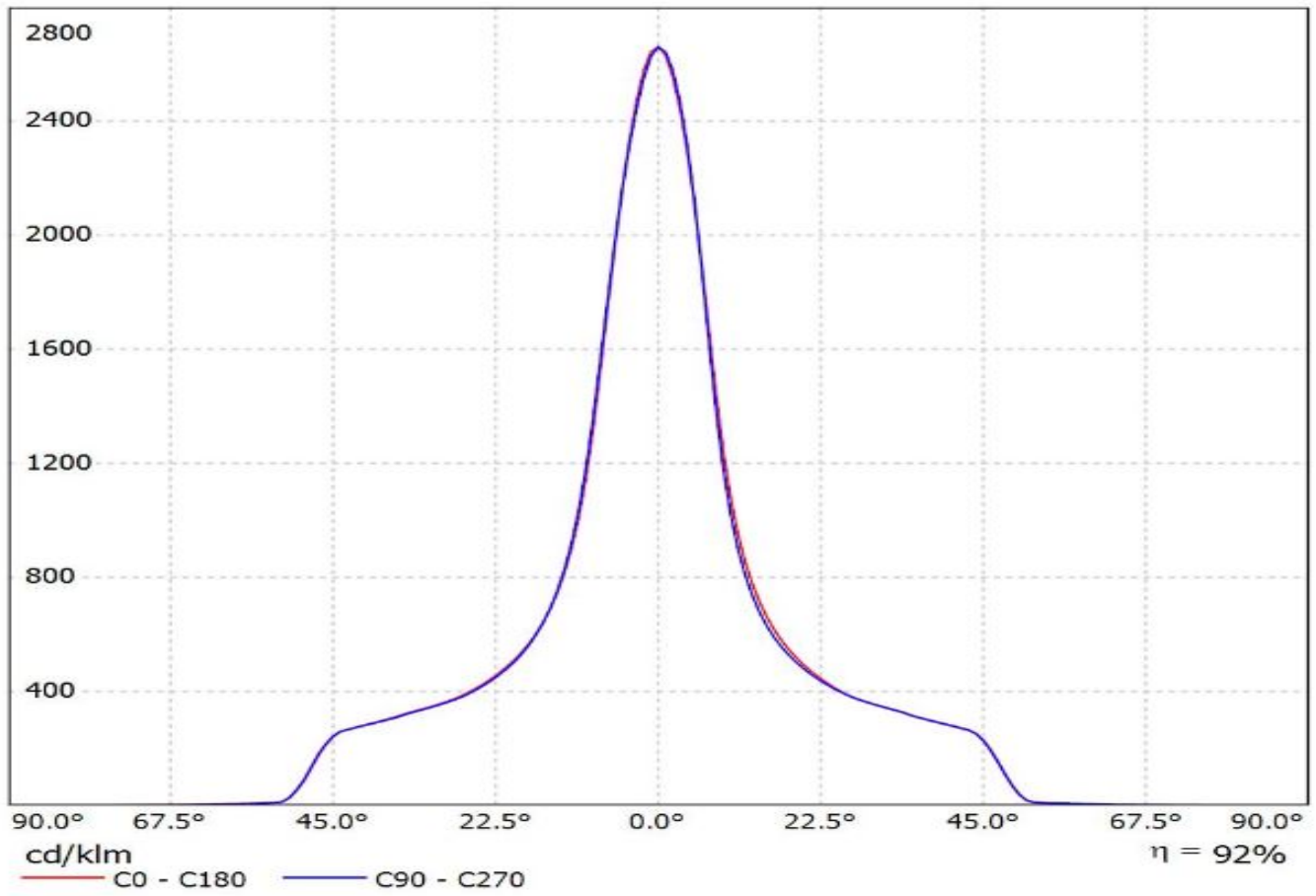

Luminaire: LEDiL Oy F13325_ANGELINA-S_(PrevaLED_LES9) Eff. 94%
Lamps: 1 x PrevaLED_LES9_(PL-CORE-1100-830-Z3)_507.9lm@100mA_P=4.5039W_I=100.1mA

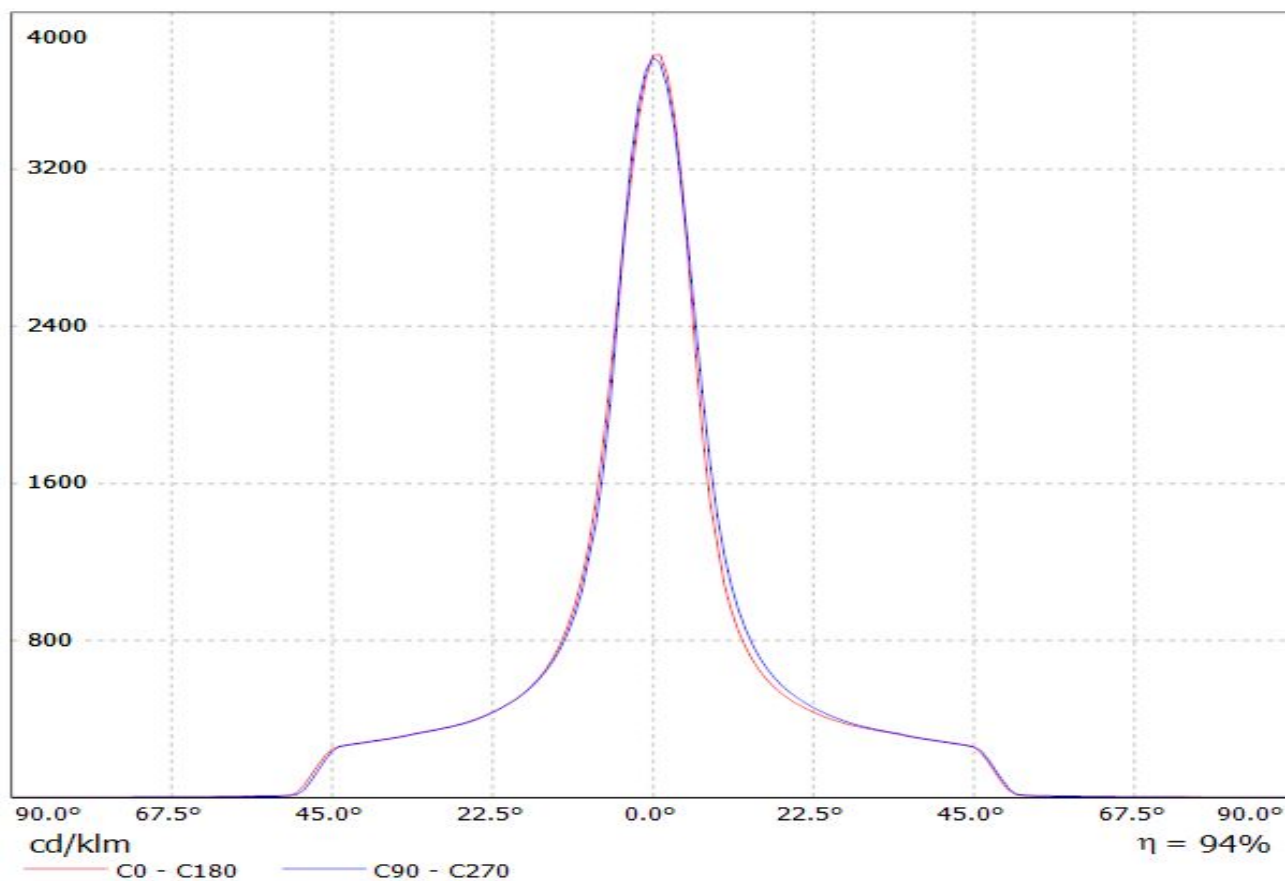

Luminaire: LEDiL Oy F13325_ANGELINA-S_(PrevaLED_LES19) Eff.94%

Lamps: 1 x OSRAM PrevaLED_LES9_(PL-CORE-1100-830-Z3)_1333.47lm@250mA_P=10.4584W_I=249.8mA

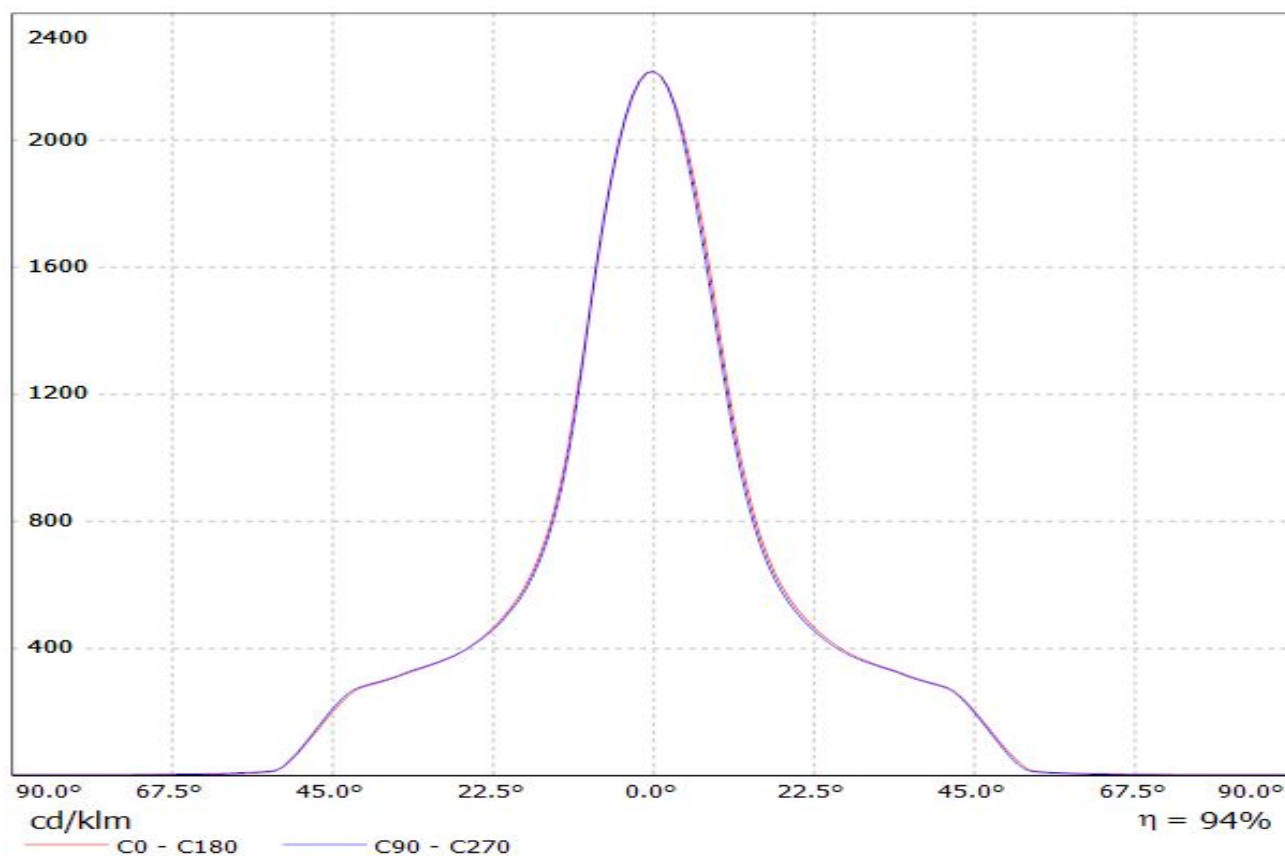

Luminaire: LEDiL Oy F13325_ANGELINA-S_(PrevaLED_LES23) Eff. 94%
Lamps: 1 x OSRAM PrevaLED_LES23_(PL-CORE-5000-930-Z3)_1102.2lm@250mA_P=9.93654W_I=249.8mA

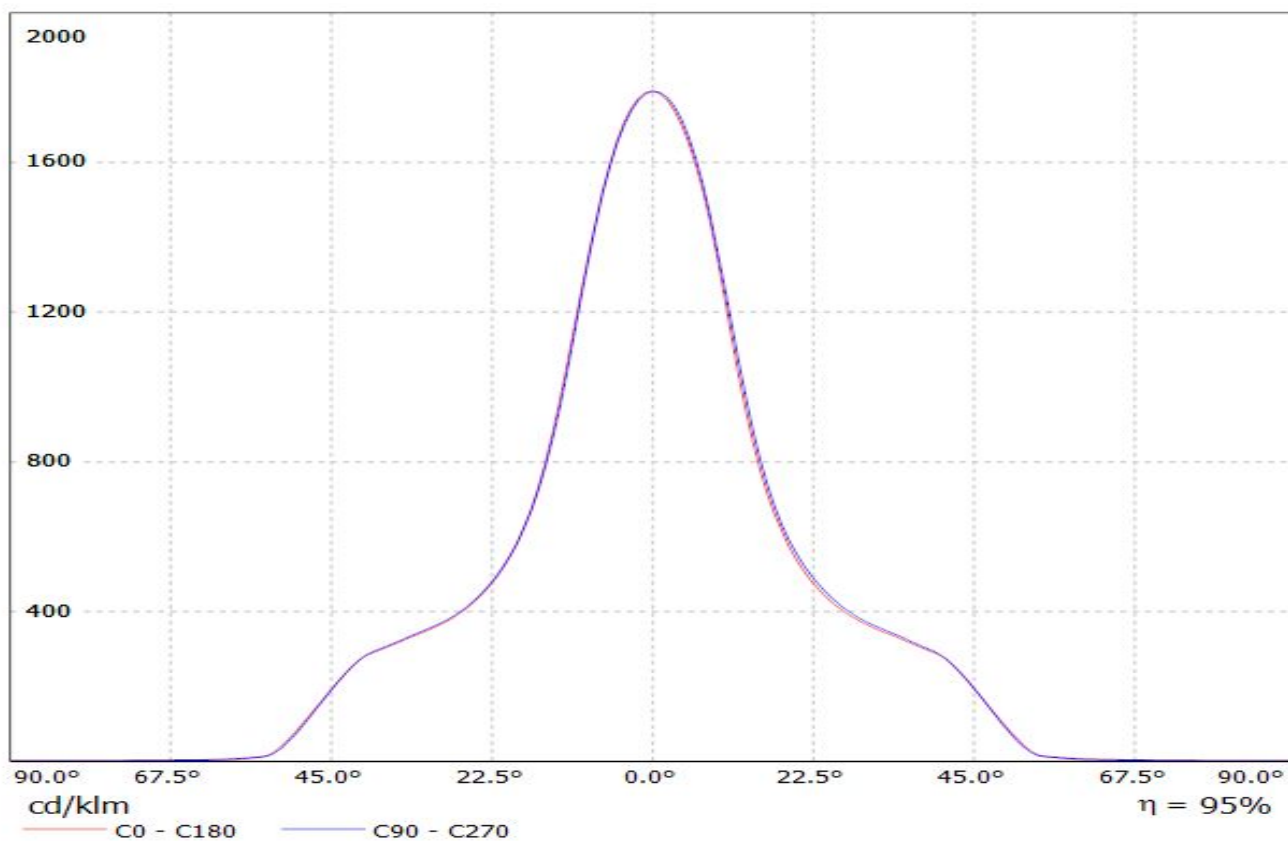

Luminaire: LEDil OY F13325_ANGELINA-S_(Soleriq_S13) Efficiency=94%
Lamps: 1 x Osram Soleriq S13 (GW KAGHB1.EM) 855lm @ 250mA CCT=3100K P=7.5W I=250mA

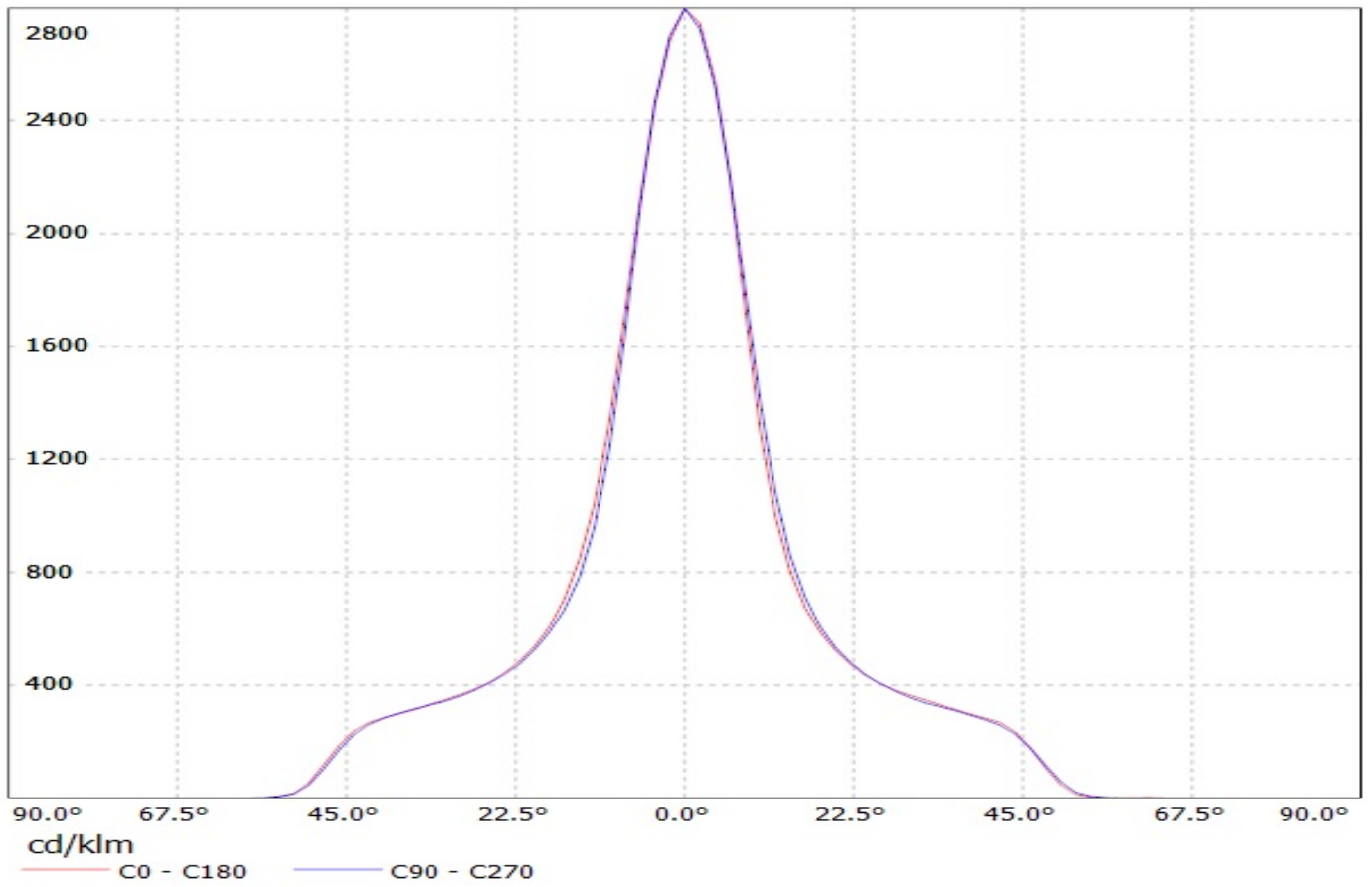

Luminaire: LEDiL Oy F13325_ANGELINA-S_(SOLERIQ_S19_&_TE_2213407-2)

Lamps: 1 x OSRAM_SOLERIQ_S19_(GW_KAHJB1.EM)_1385.15lm@250mA_CCT=3000K_P=10.5613W_I=249.8mA

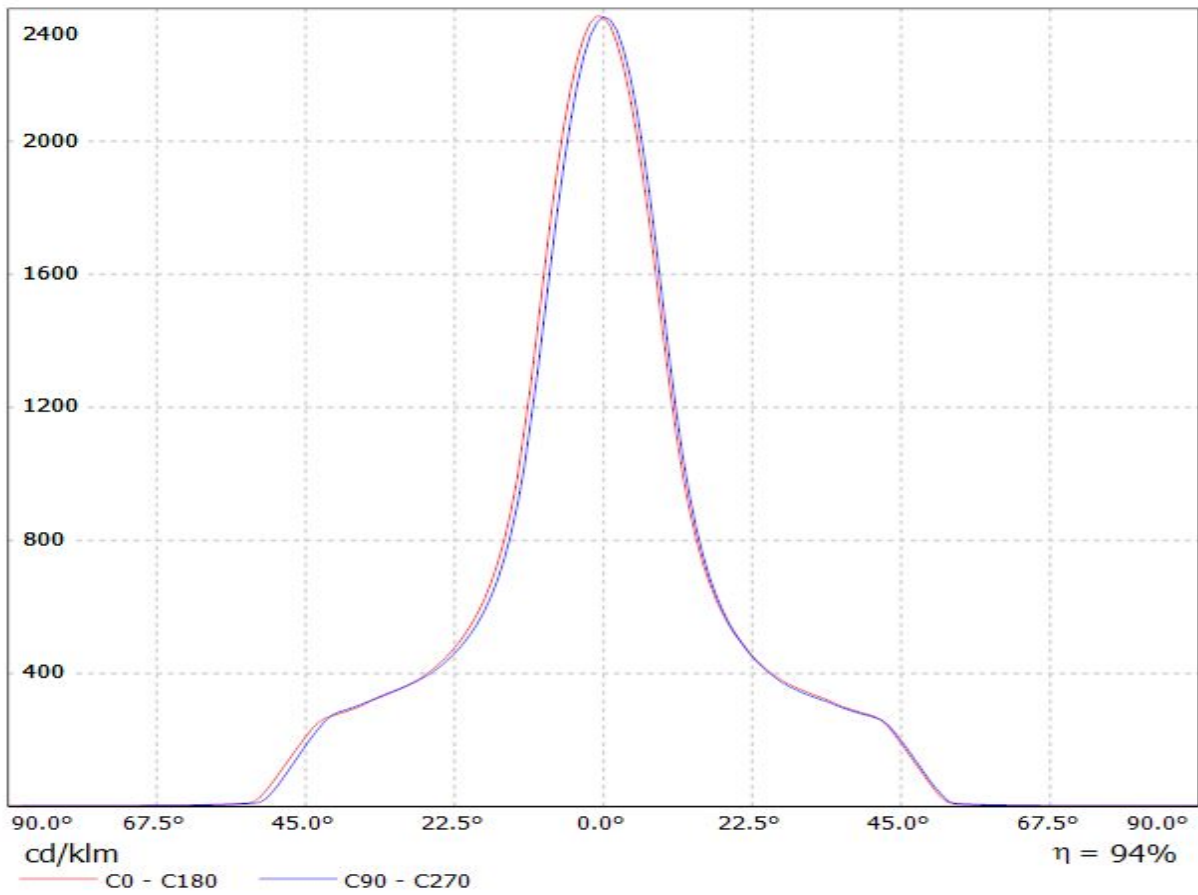

Luminaire: LEDiL Oy F13325_ANGELINA-S_(LEP-800-827-C-AC)
Lamps: 1 x OSRAM PrevaLED Core AC (LEP-800-827-C-AC) 910lm@60mA U:230V P:14W

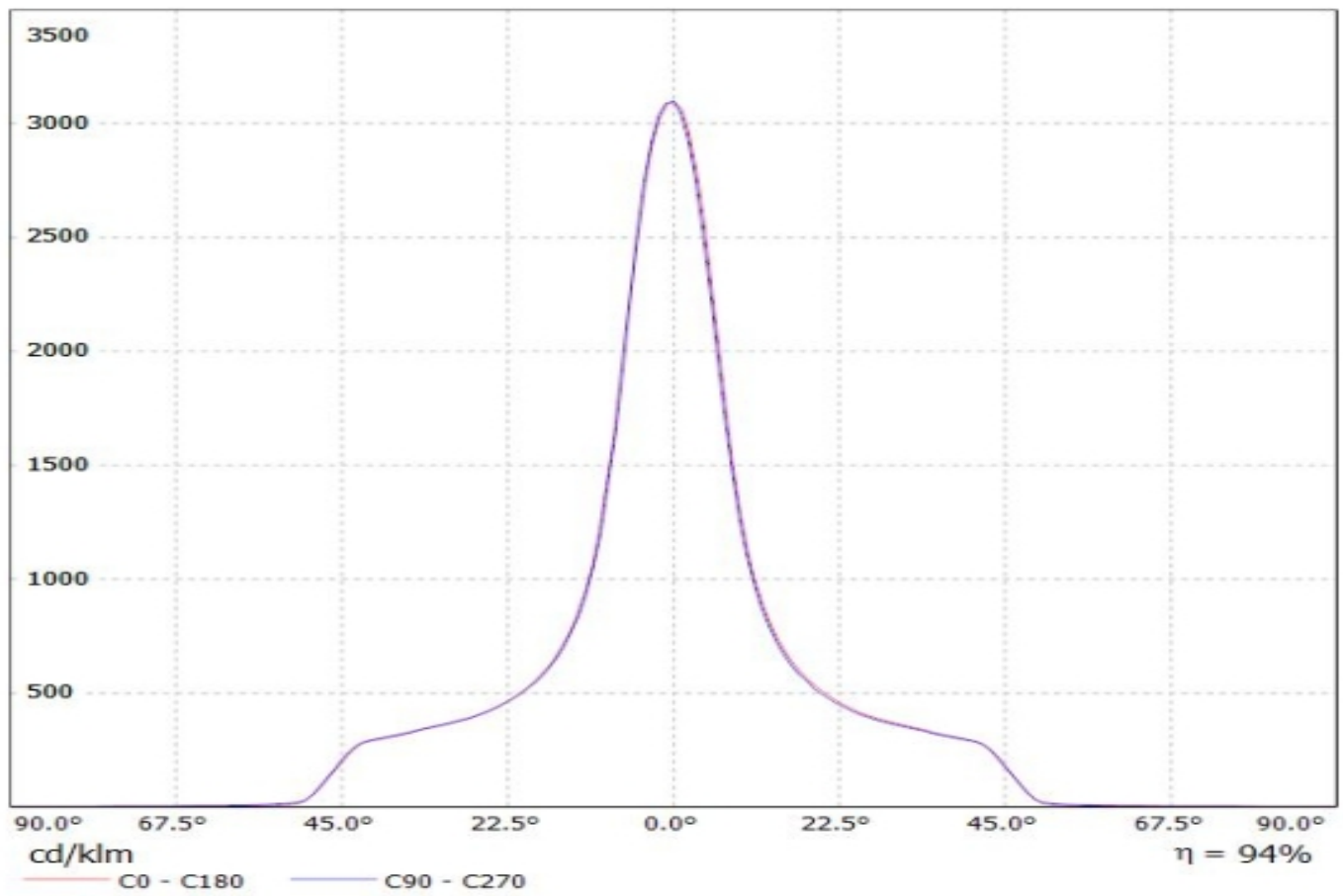

Luminaire: LEDiL Oy F13325_ANGELINA-S_(LEP-2000-827-C-AC)
Lamps: 1 x OSRAM PrevaLED Core AC (LEP-2000-827-C-AC)

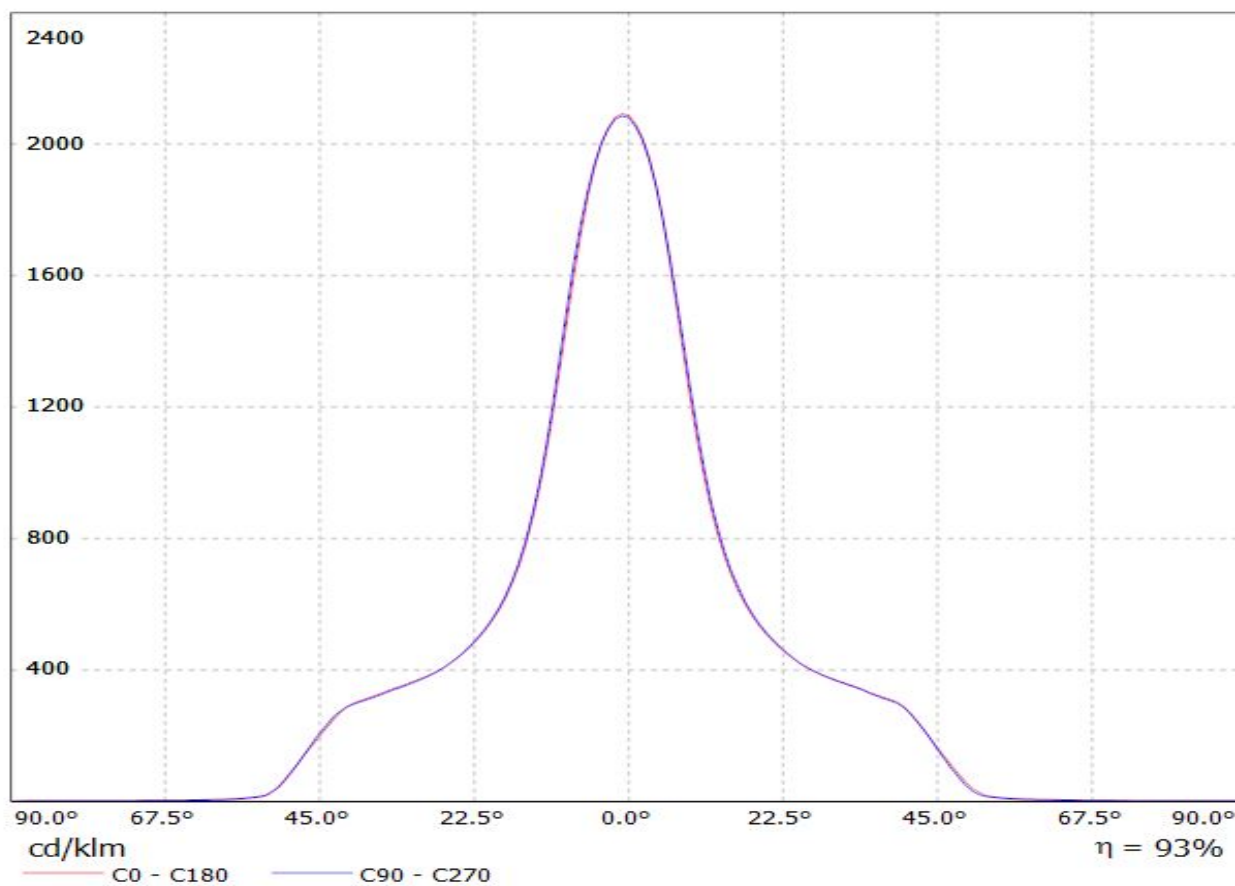

Luminaire: LEDiL Oy F13325_ANGELINA-S (PrevaLED_Z4) Eff:94%

Lamps: 1 x Osram_PrevaLED_CORE_Z4 (PL-CORE-3000-830-Z4)_1423.93lm@250mA_P=10.7652W_I=249.9mA

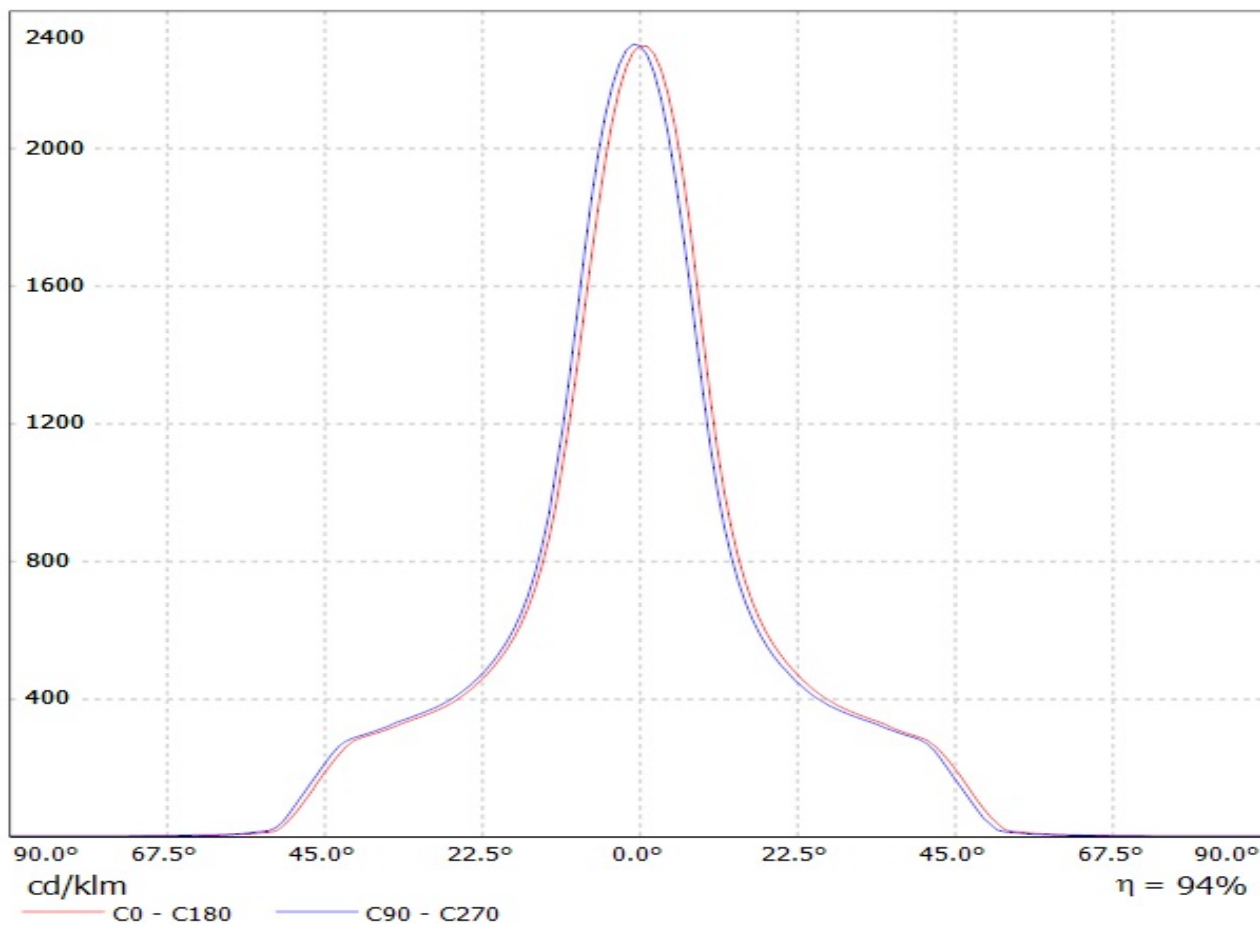

Luminaire: LEDiL Oy F13325_ANGELINA-S_(SOLERIQ_P13)

Lamps: 1 x SOLERIQ_P13_(GW_MAGMB1.EM)_1038.25lm@250mA_CCT=3000K_P=8.77223W_I=249.8mA

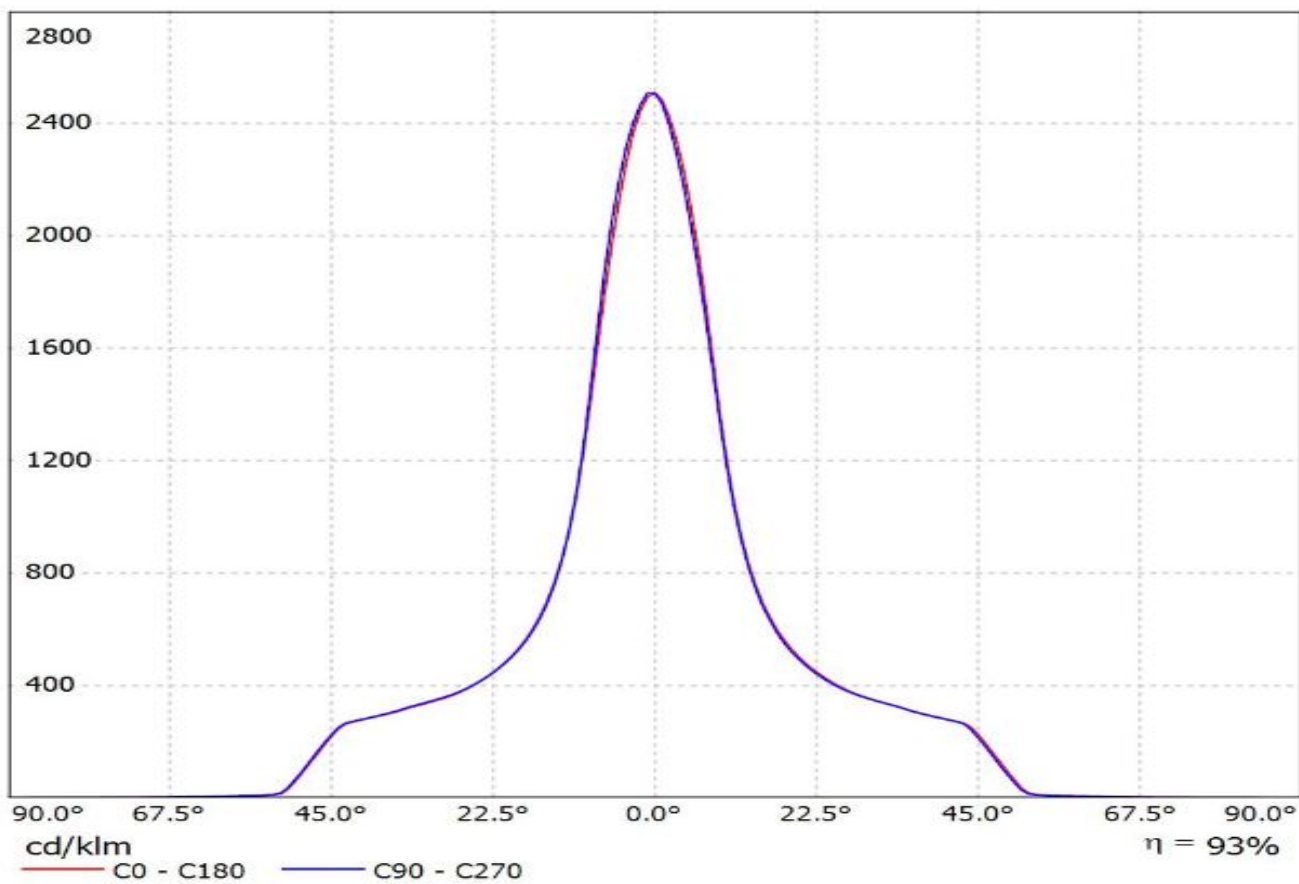

Luminaire: Ledil F13325_ANGELINA-S_(S13_Gen2+TE)

Lamps: 1 x Soleriq_S13_Gen2+_2213254-2+_2213194-1_1309.23lm@250mA_P=8.7840W_I=0.250A

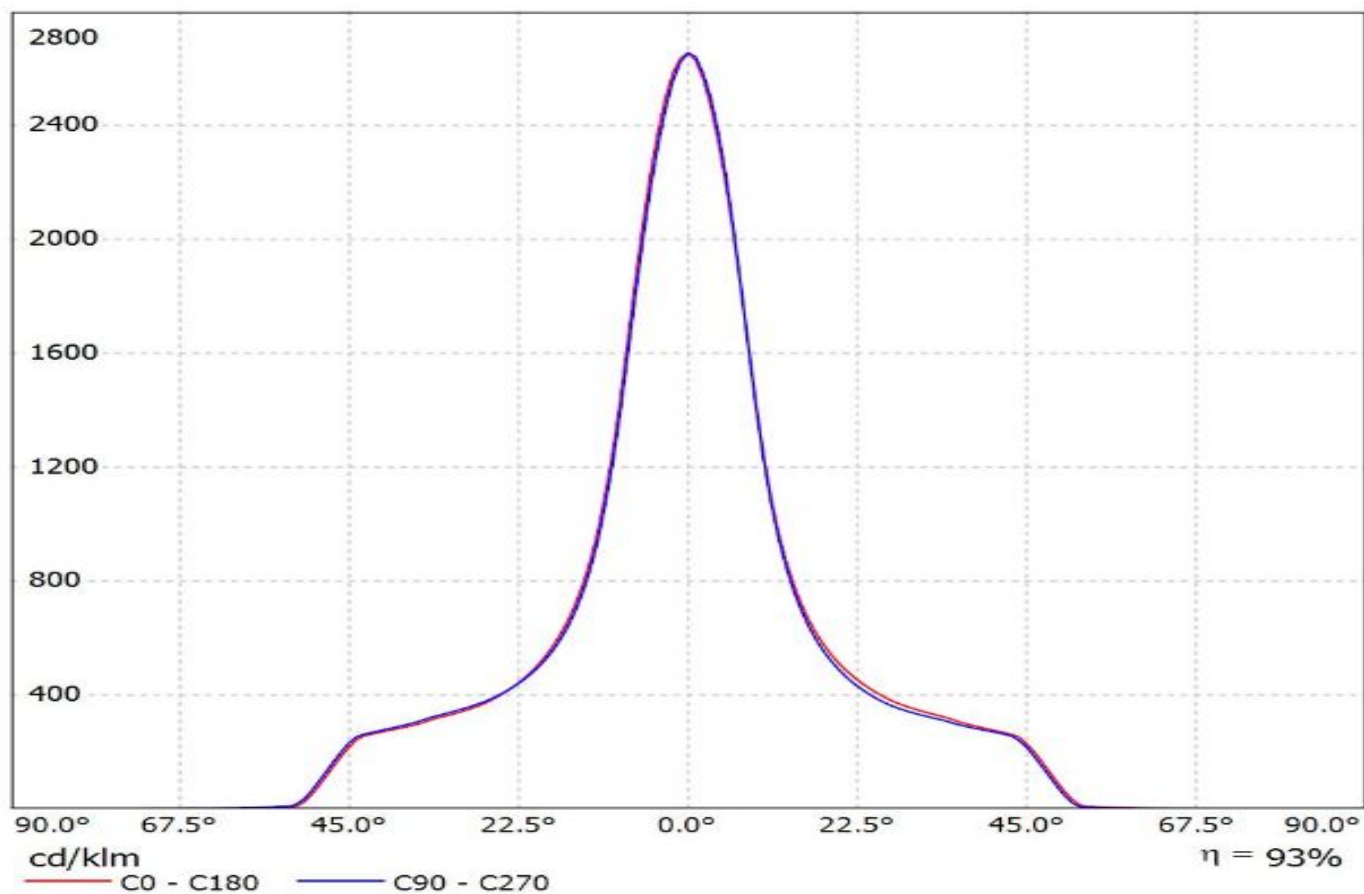

Luminaire: Ledil F13325_ANGELINA-S_(S13_Gen2+IDEAL)

Lamps: 1 x Soleriq_S13_Gen2+_50-2103CT+_50-2100AN_1327.38lm@250mA_P=8.7850W_I=0.250A

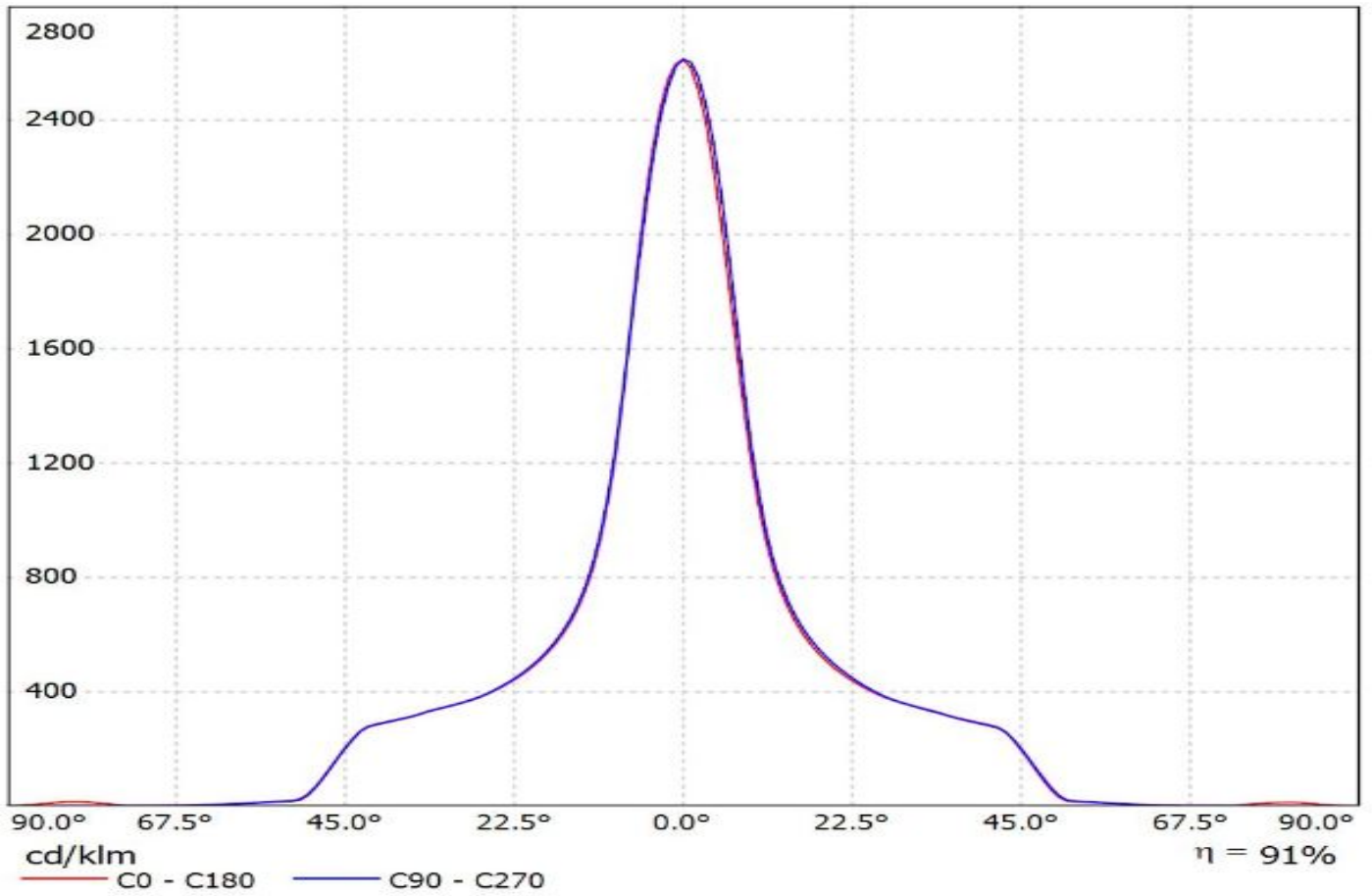

Luminaire: LEDiL Oy F13325_ANGELINA-S_(FORTIMO_2000) Eff.90.7%
Lamps: 1 x PHILIPS Fortimo LED SLM 2000 23W/930 L19 G3 665.774lm@250mA CCT=3000K P=6W I=250mA

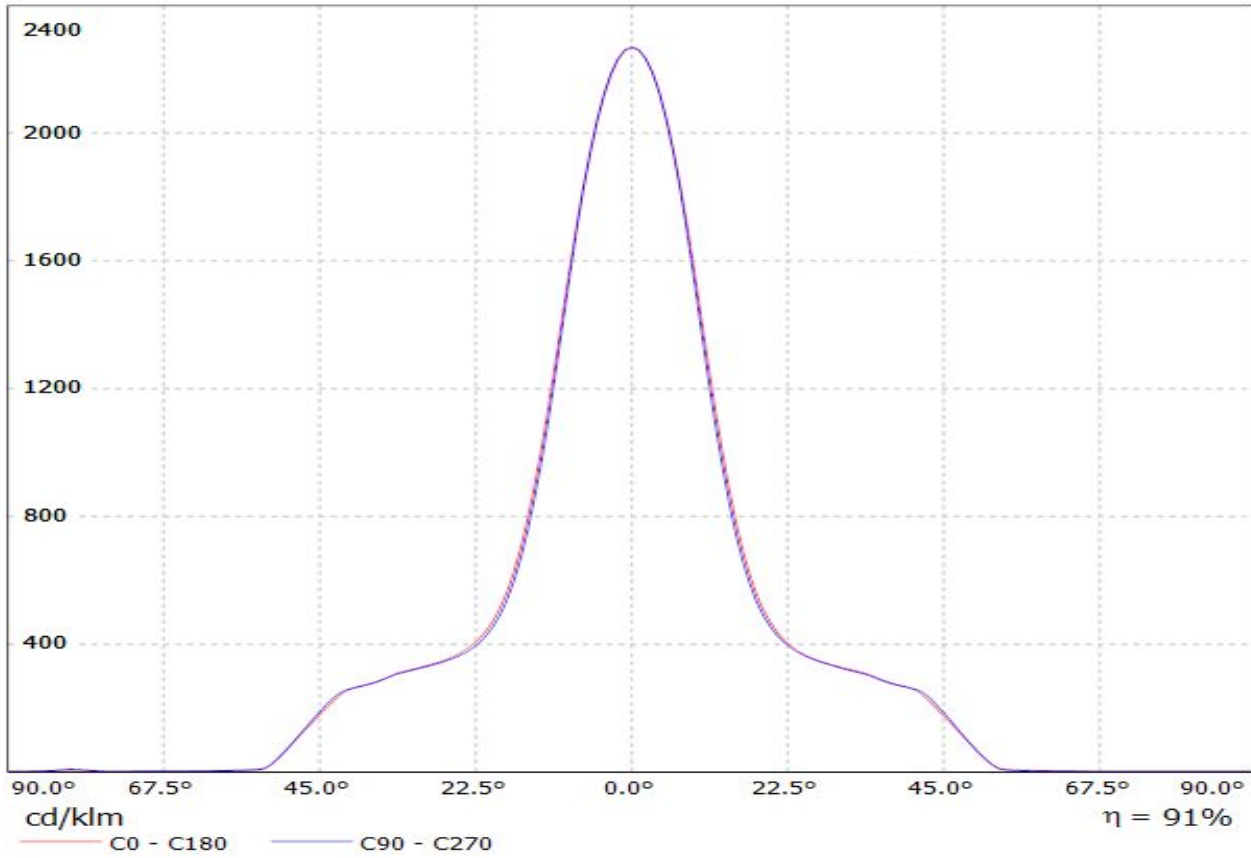

Luminaire: LEDiL Oy F13325_ANGELINA-S_(FORTIMO_3000) Eff.90.9%
Lamps: 1 x PHILIPS Fortimo LED SLM 3000 28W/830 L19 G3 1046.76lm@250mA CCT=3000K P=9W I=250mA

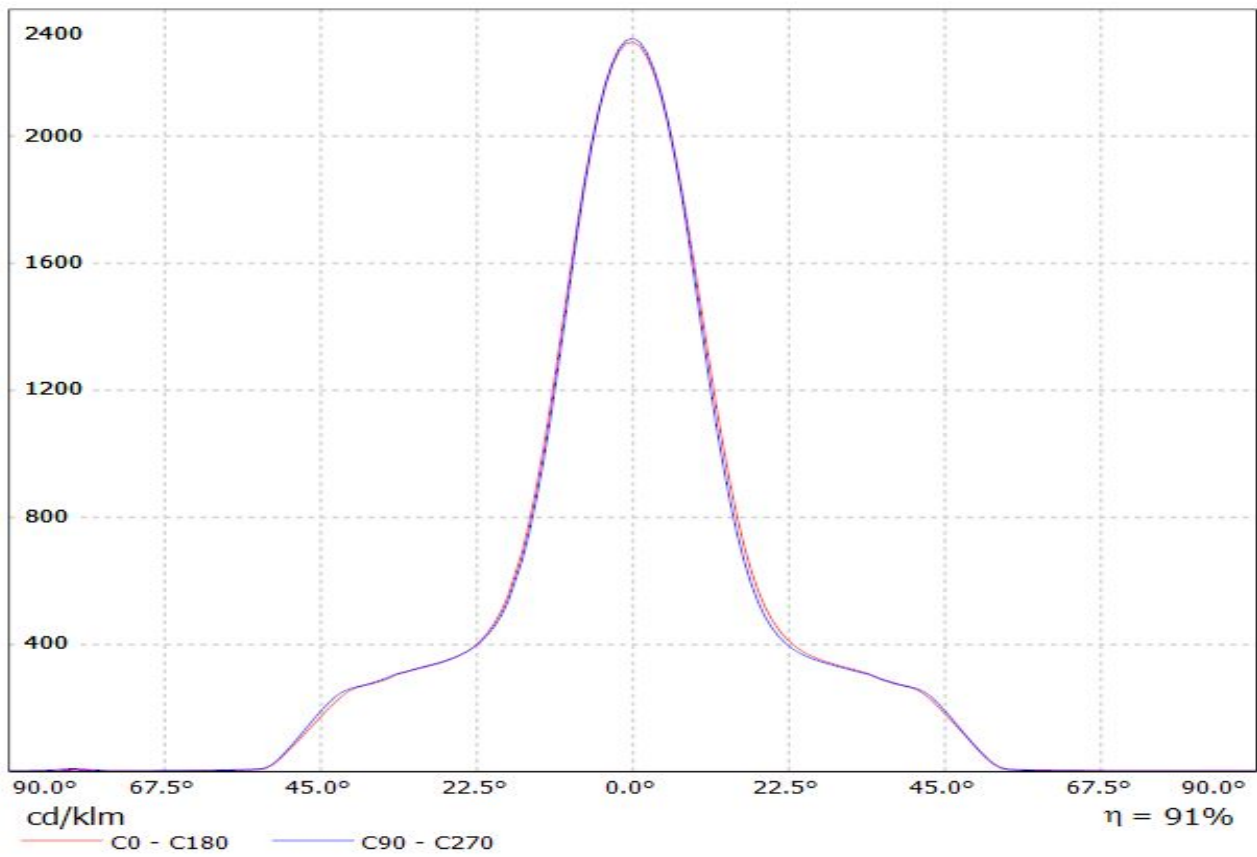

Luminaire: LEDiL Oy F13325_ANGELINA-S_(FORTIMO_4500) Eff.89.2%
Lamps: 1 x PHILIPS Fortimo 4500 1197lm@250mA I:250mA P:10.8W

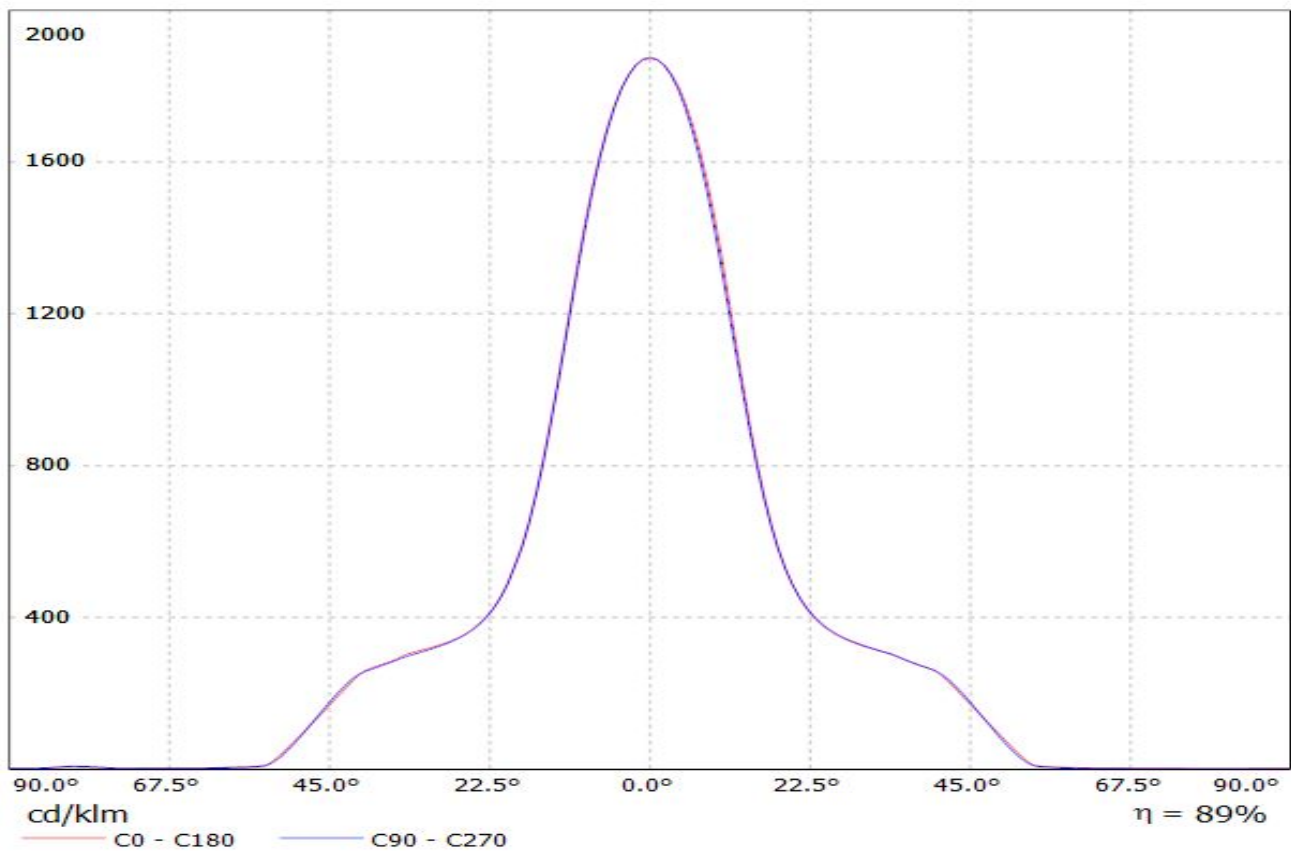

Luminaire: LEDiL Oy F13325_ANGELINA-S_(Fortimo LED SLM 1100 Im 830 L9 G4)
Lamps: 1 x Fortimo LED SLM 1100 Im 830 L9 G4_1021.27lm@250mA_P=9.2431W_I=0.2498A

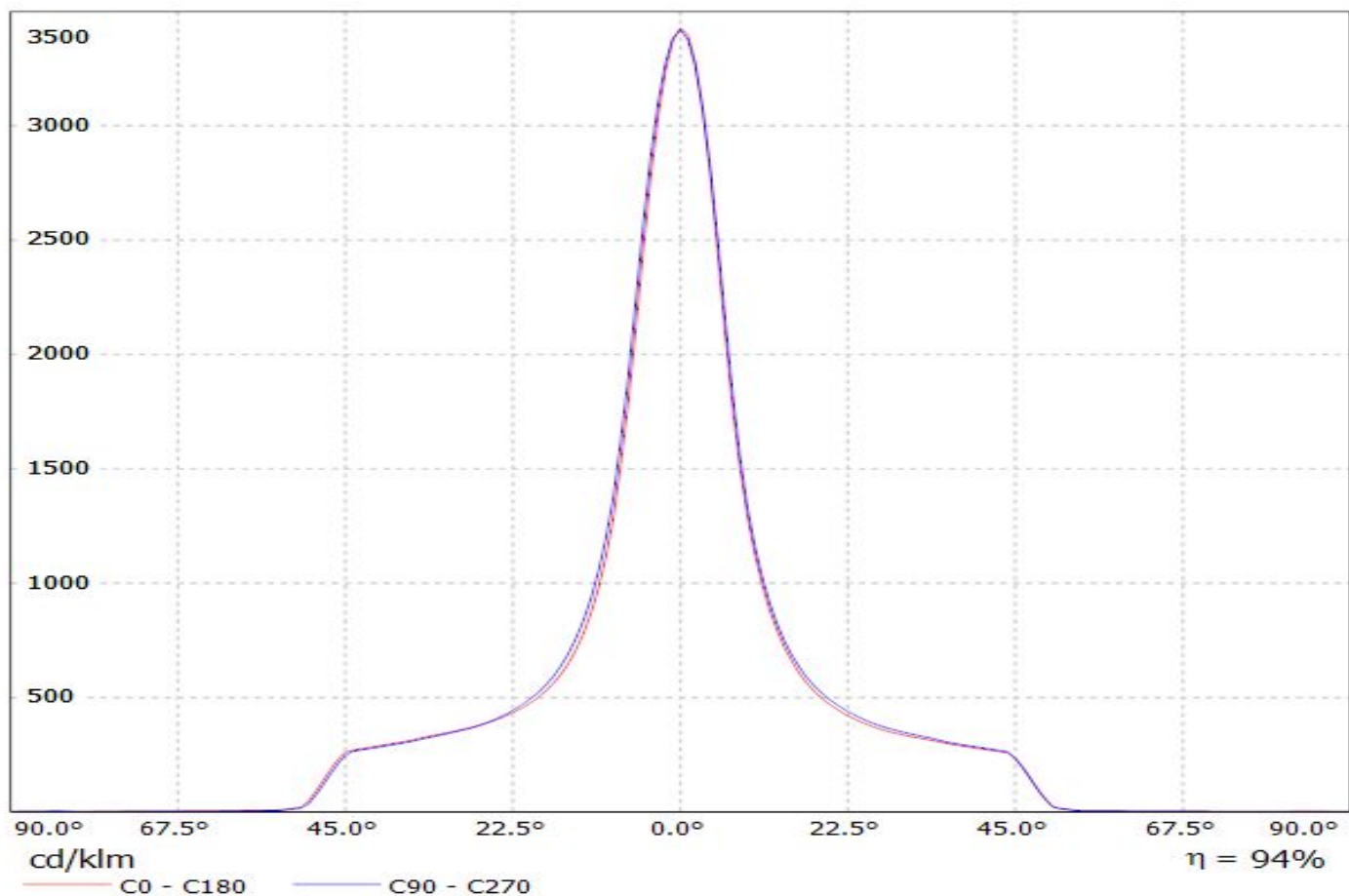

Luminaire: LEDiL Oy F13325_ANGELINA-S_(Fortimo LED SLM L13 G4)
Lamps: 1 x Fortimo LED SLM L13 G4_1030.19lm@250mA_P=8.38104W_η=0.2498A

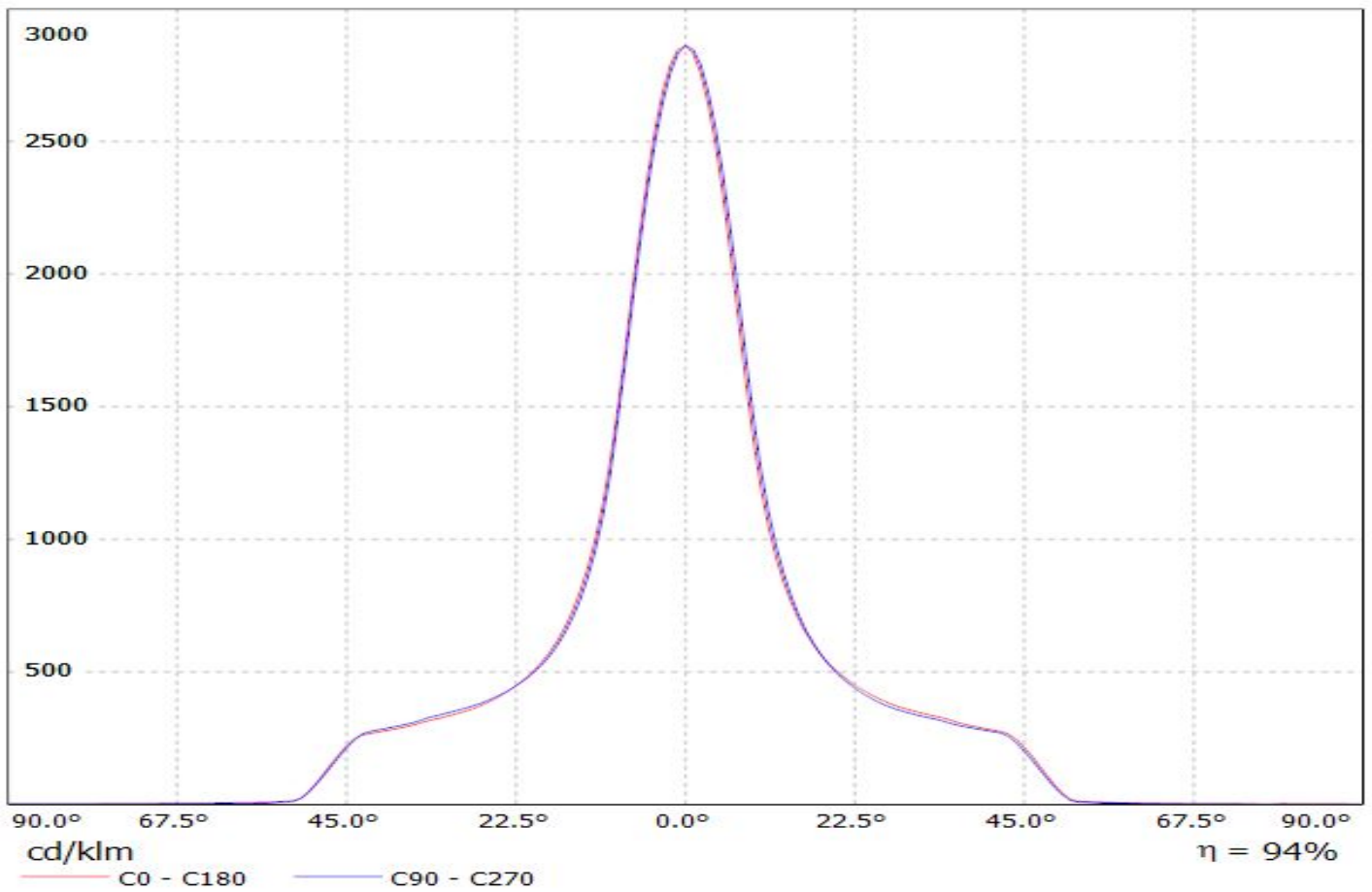

Luminaire: LEDiL Oy F13325_ANGELINA-S_(Fortimo LED SLM L15 G4)
Lamps: 1 x Fortimo LED SLM L15 G4_1116.47lm@250mA_P=8.21168W_I=0.2498A

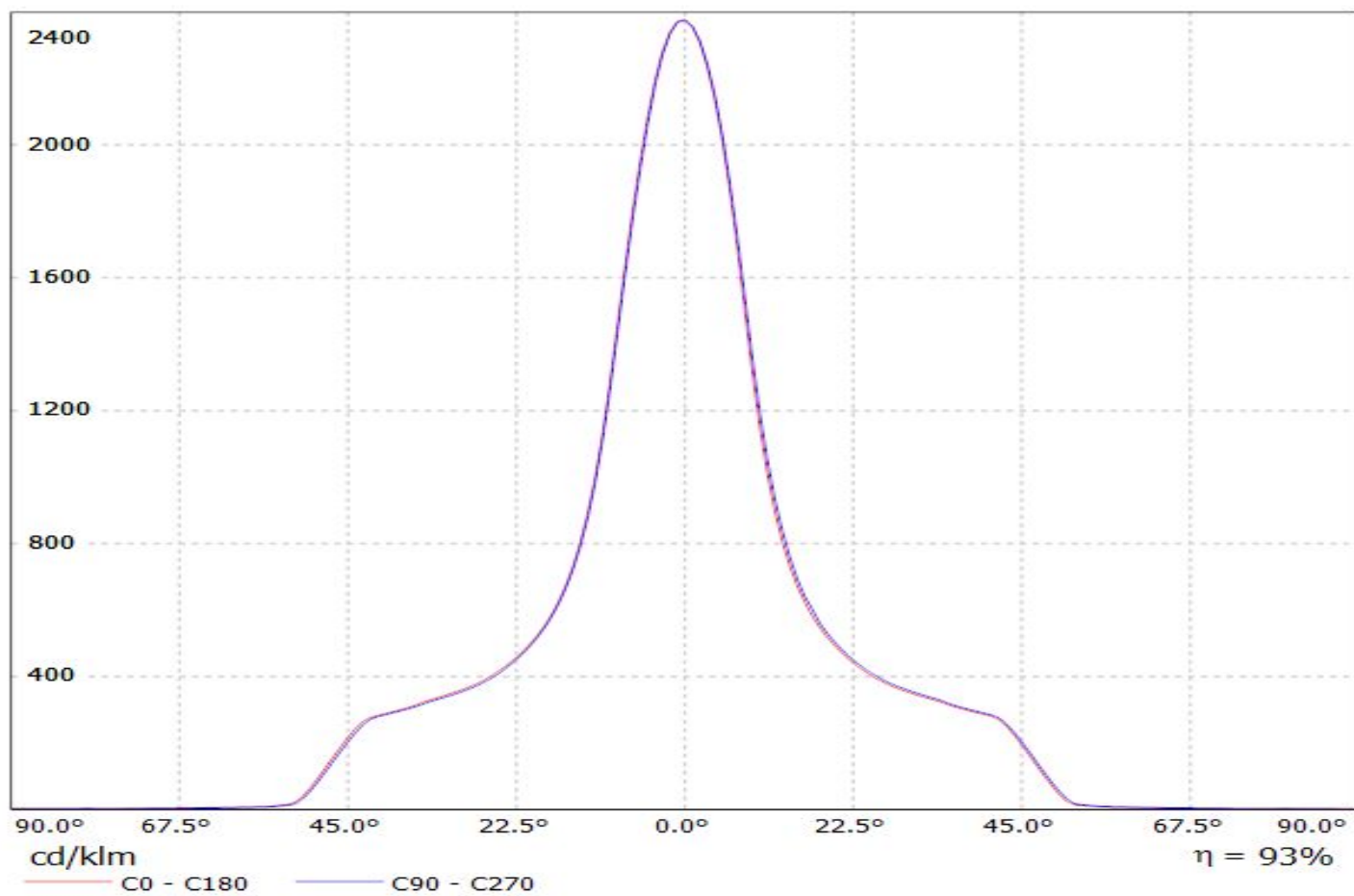

Luminaire: LEDiL Oy F13325_ANGELINA-S_(Fortimo LED SLM L19 G4)
Lamps: 1 x Fortimo LED SLM L19 G4_1114.89lm@250mA_P=8.04906W_I=0.2498A

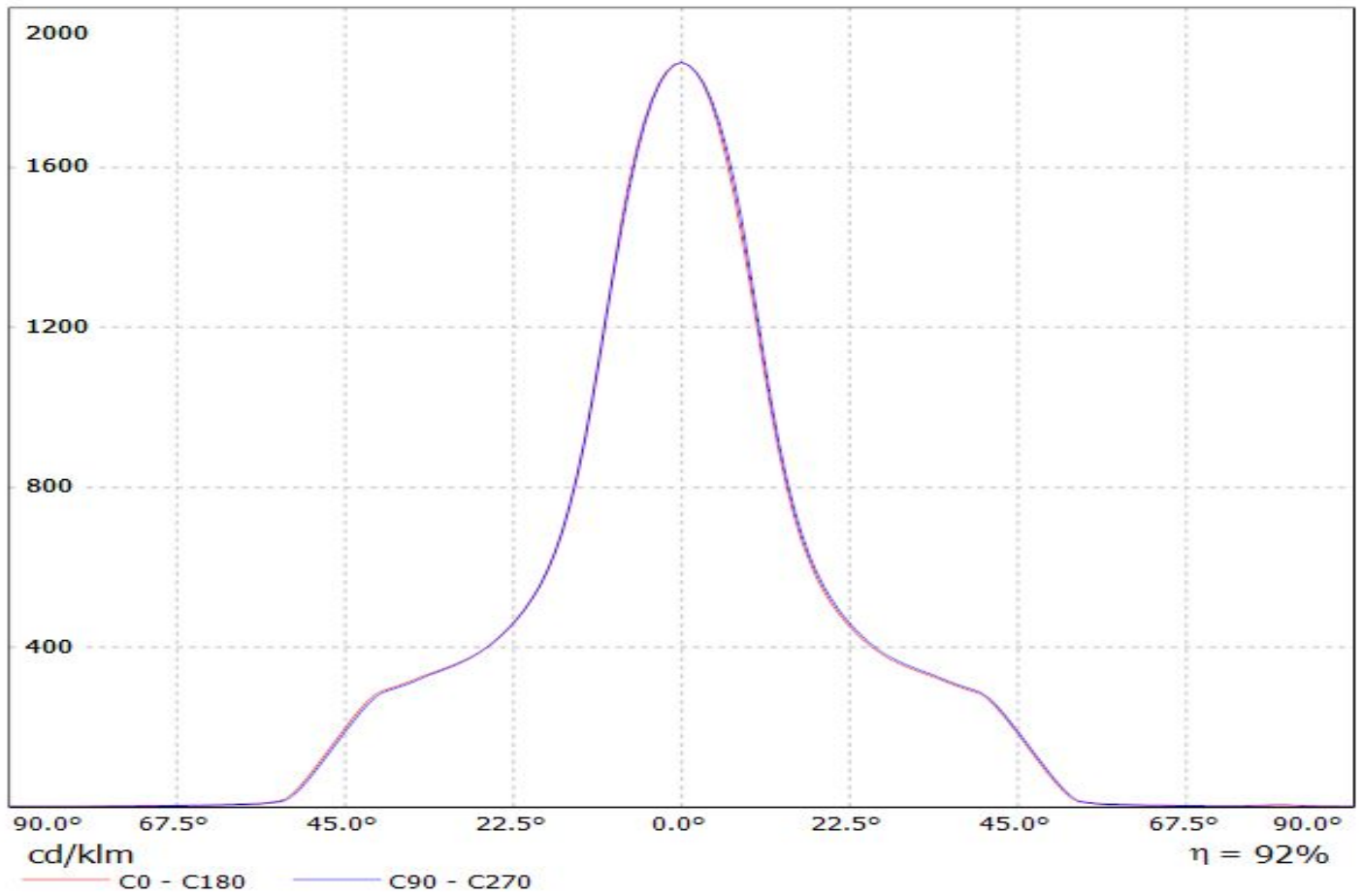

Luminaire: LEDiL Oy F13325_ANGELINA-S_(SLM-G5-LES-9)_(Z50-Optic-Clip)
Lamps: 1 x Fortimo_SLM-G5-LES-9_1182.49lm@250mA_P=8.5848W_I=0.250A

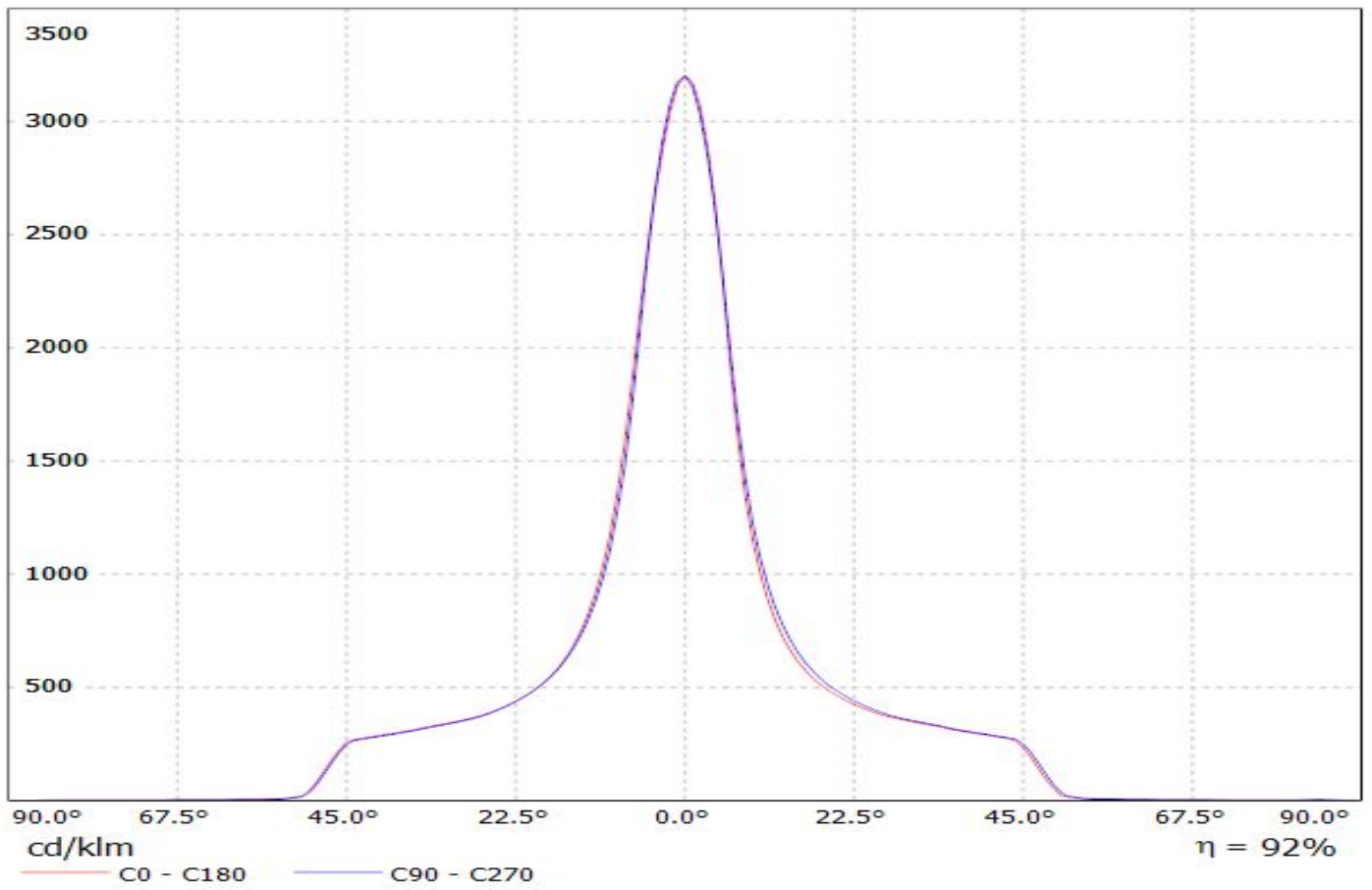

Luminaire: LEDiL Oy F13325_ANGELINA-S_(SLM-G5_LES-15)
Lamps: 1 x Fortimo_SLM-G5_LES-15_1257.6lm@250mA_P=8.1569W_I=0.250A

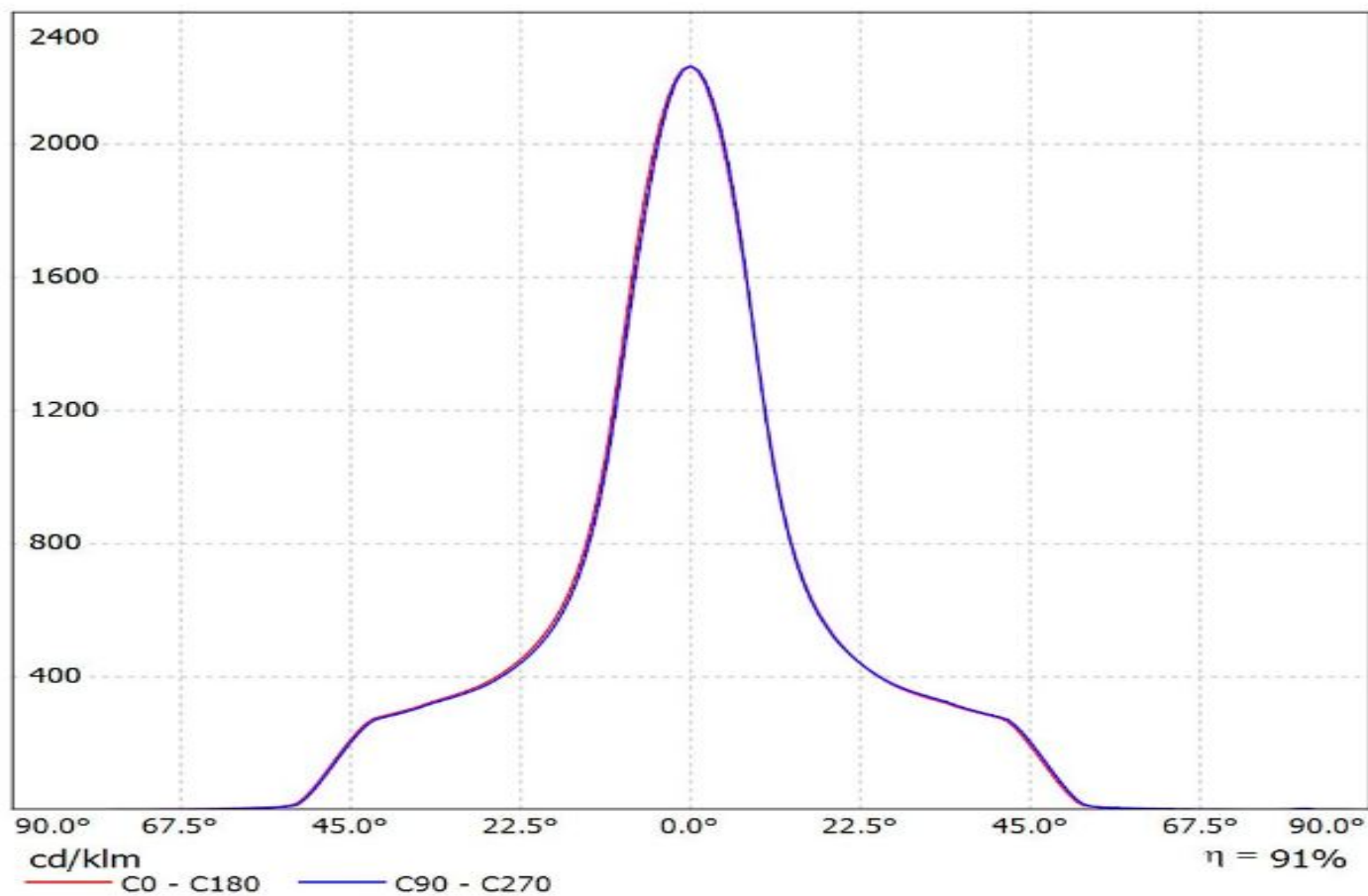

Luminaire: LEDiL Oy F13325_ANGELINA-S-WAS_(SLM-G5_LES-19)_(Z50_Optic_Clip)
Lamps: 1 x Fortimo_SLM-G5_LES-19_1397.58lm@250mA_P=8.0385W_I=0.250A

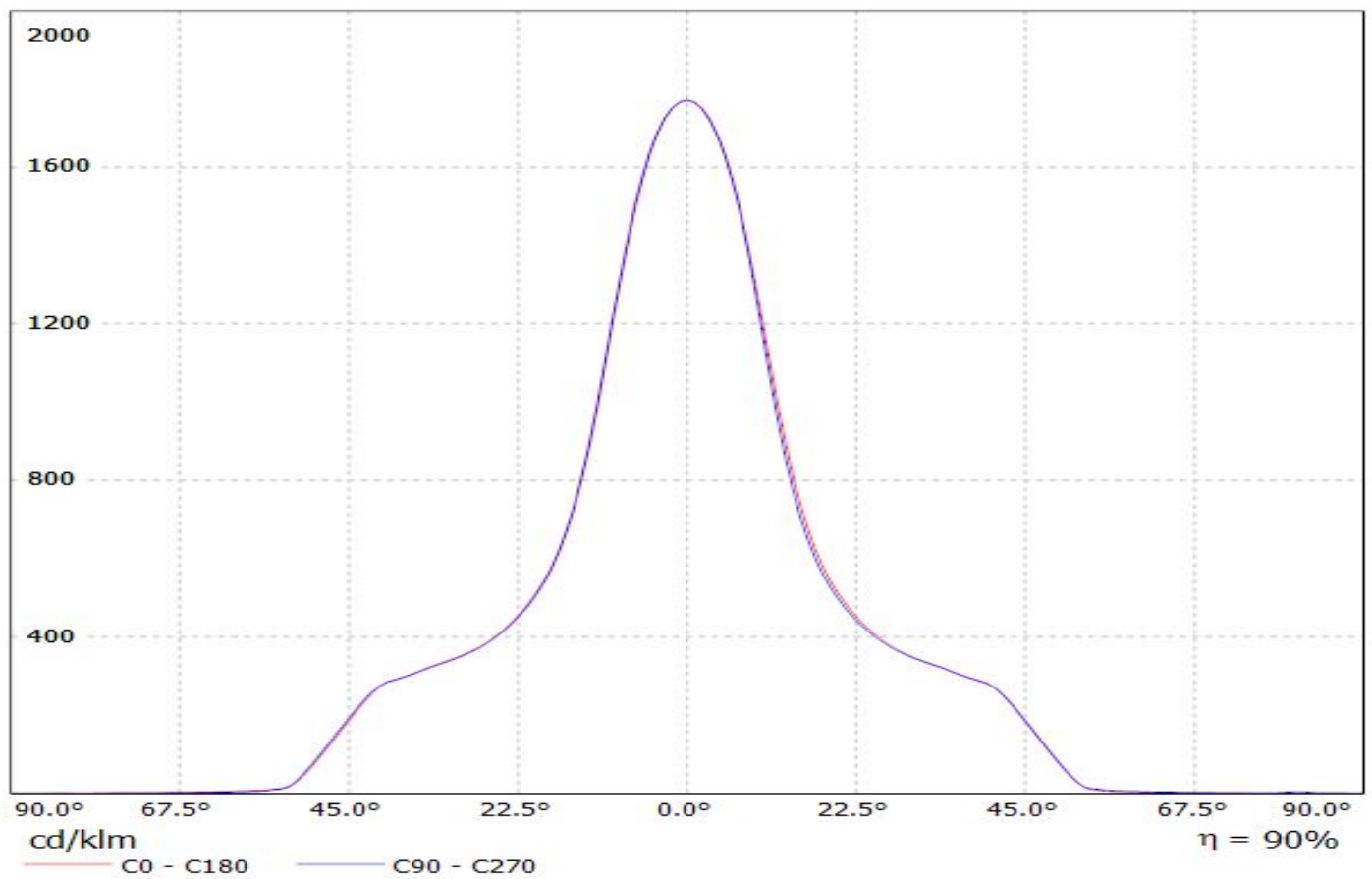

Luminaire: LEDiL Oy F13325_ANGELINA-S_(SLM-G5_LES-13)_(Z50-Optic-Clip)
Lamps: 1 x Fortimo_SLM-G5_LES-13_1300.47lm@250mA_P=8.4010W_I=0.250A

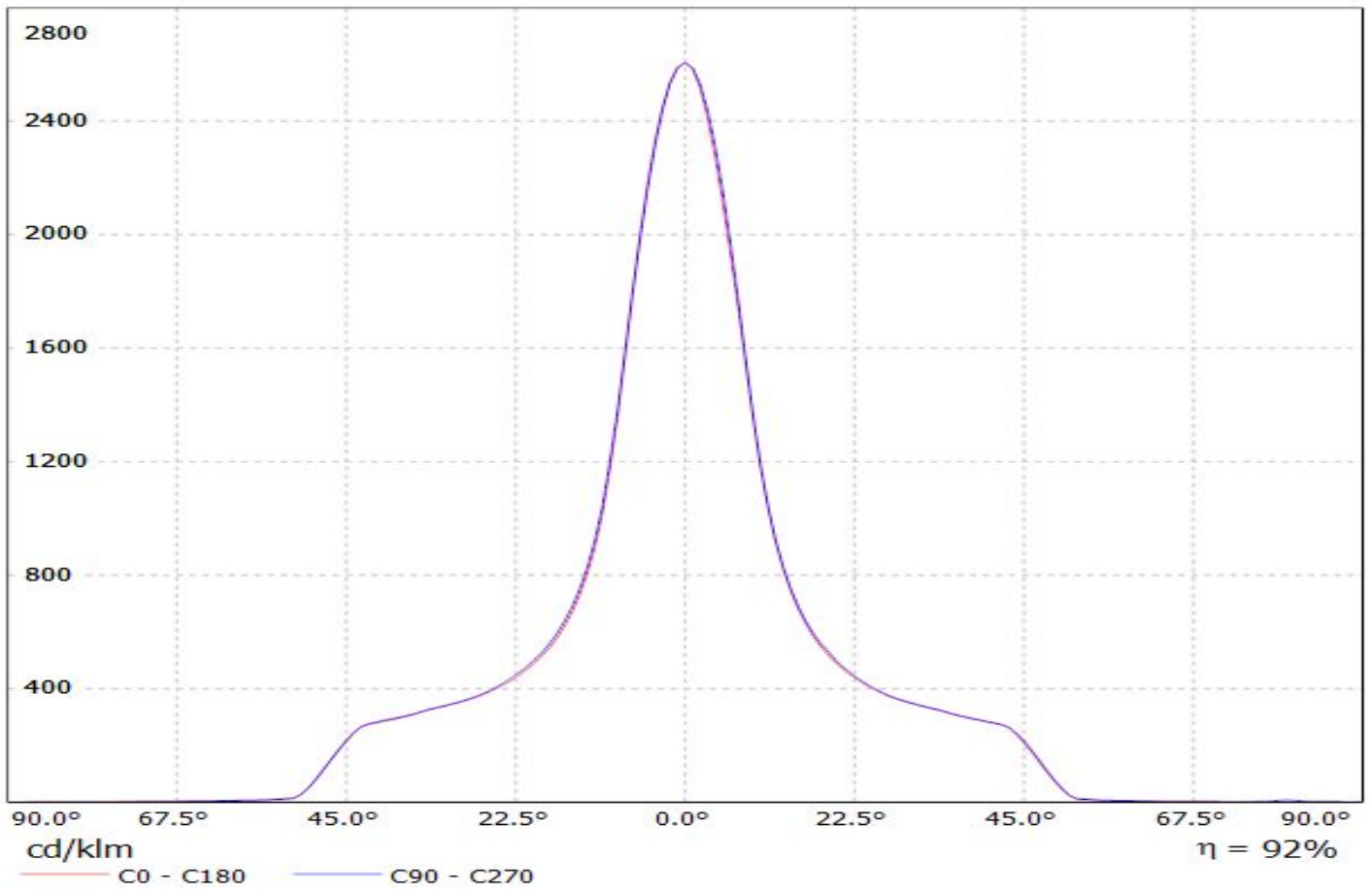

Luminaire: Ledil F13325_ANGELINA-S_(SLM_1211_L19_G6_+TE)

Lamps: 1 x Philips_Fortimo_SLM_1211_L19_G6_Standard_+_TE_OPTIC_CLIP_Z50_TYPE1:_2213194-1_1146.84lm@250mA_P=8.13175W_I=0.25A

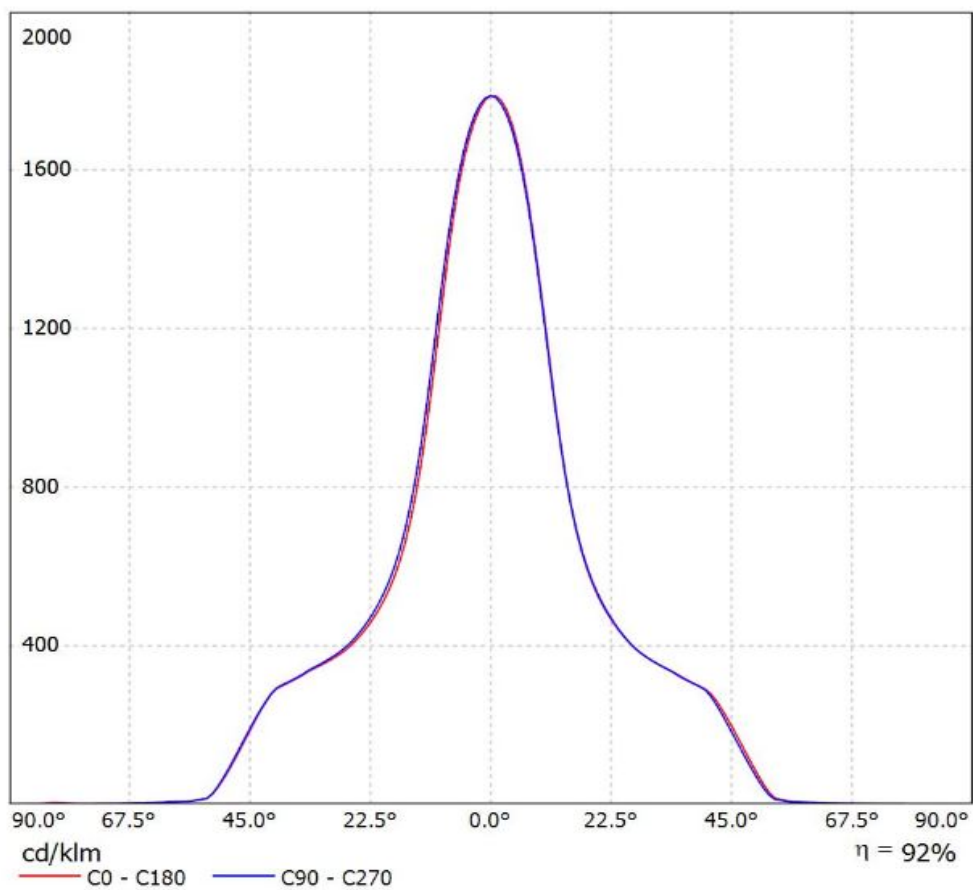

Luminaire: LEDiL Oy F13325_ANGELINA-S_(COB-LC026B) Eff.93.5%
Lamps: 1 x SAMSUNG_COB-LC026B_(SPHWWTHDNC25YHV52F)_1136.23lm@250mA_P=8.23191W_I=249.8mA

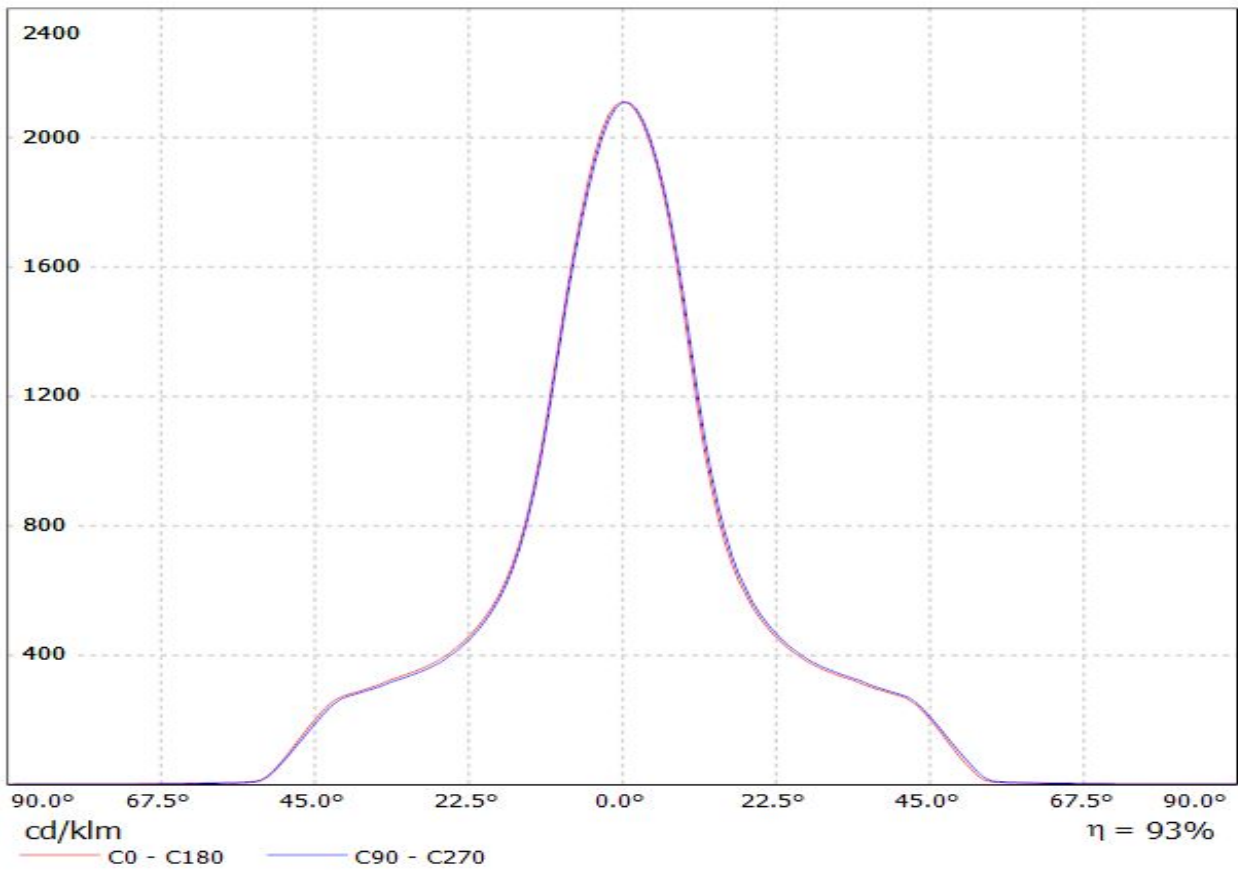

Luminaire: Ledil F13325_ANGELINA-S_(LC040C+TE)

Lamps: 1 x Samsung_LC040C+_2213382-2+_2213194-1_1194.16lm@250mA_CCT=4000K_P=8.137W

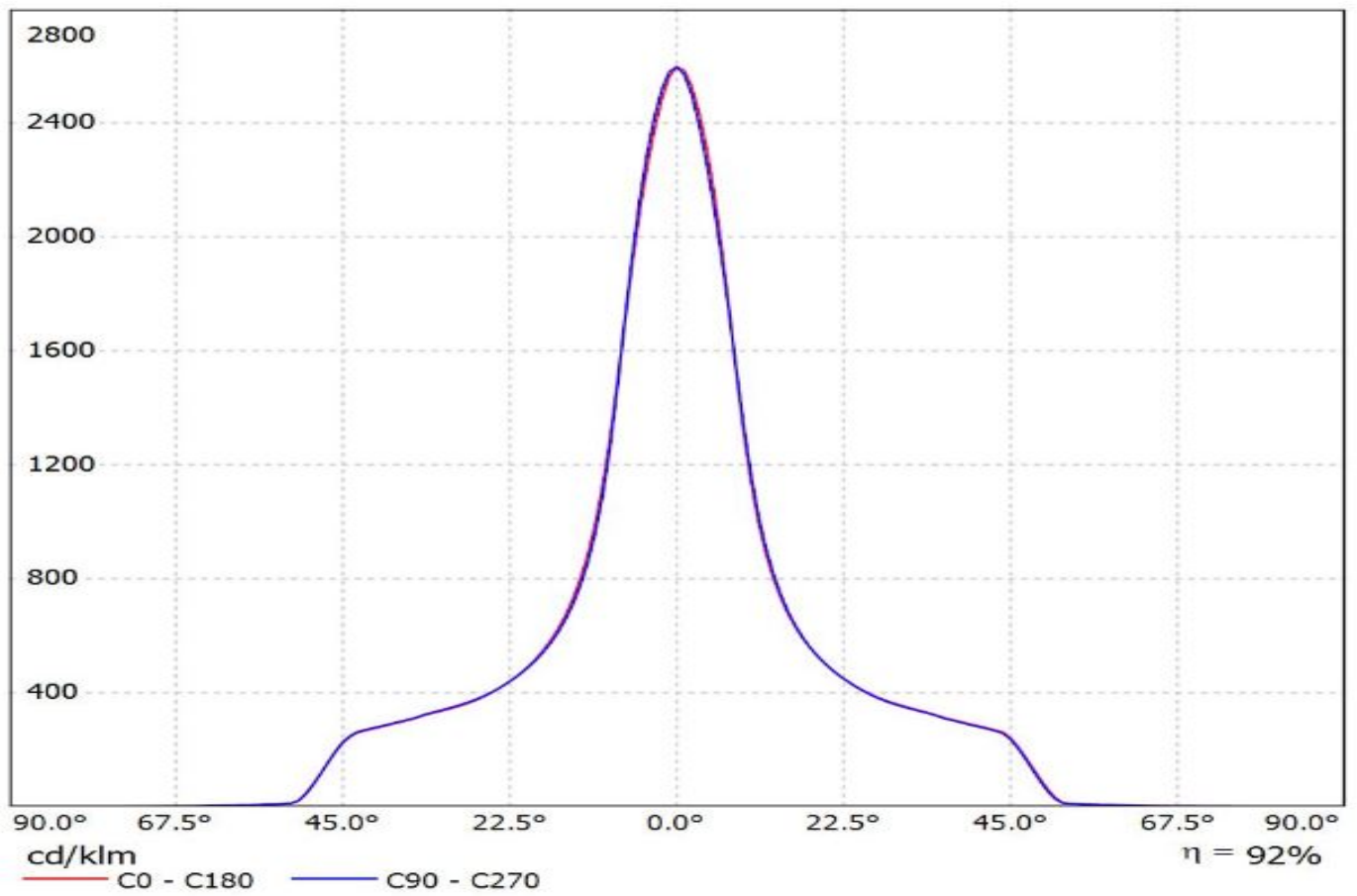

Luminaire: LEDiL Oy F13325_ANGELINA-S_(MegaZenigata) Eff.92.3%
Lamps: 1 x MegaZenigata_GW6DME (518.495lm@100mA)

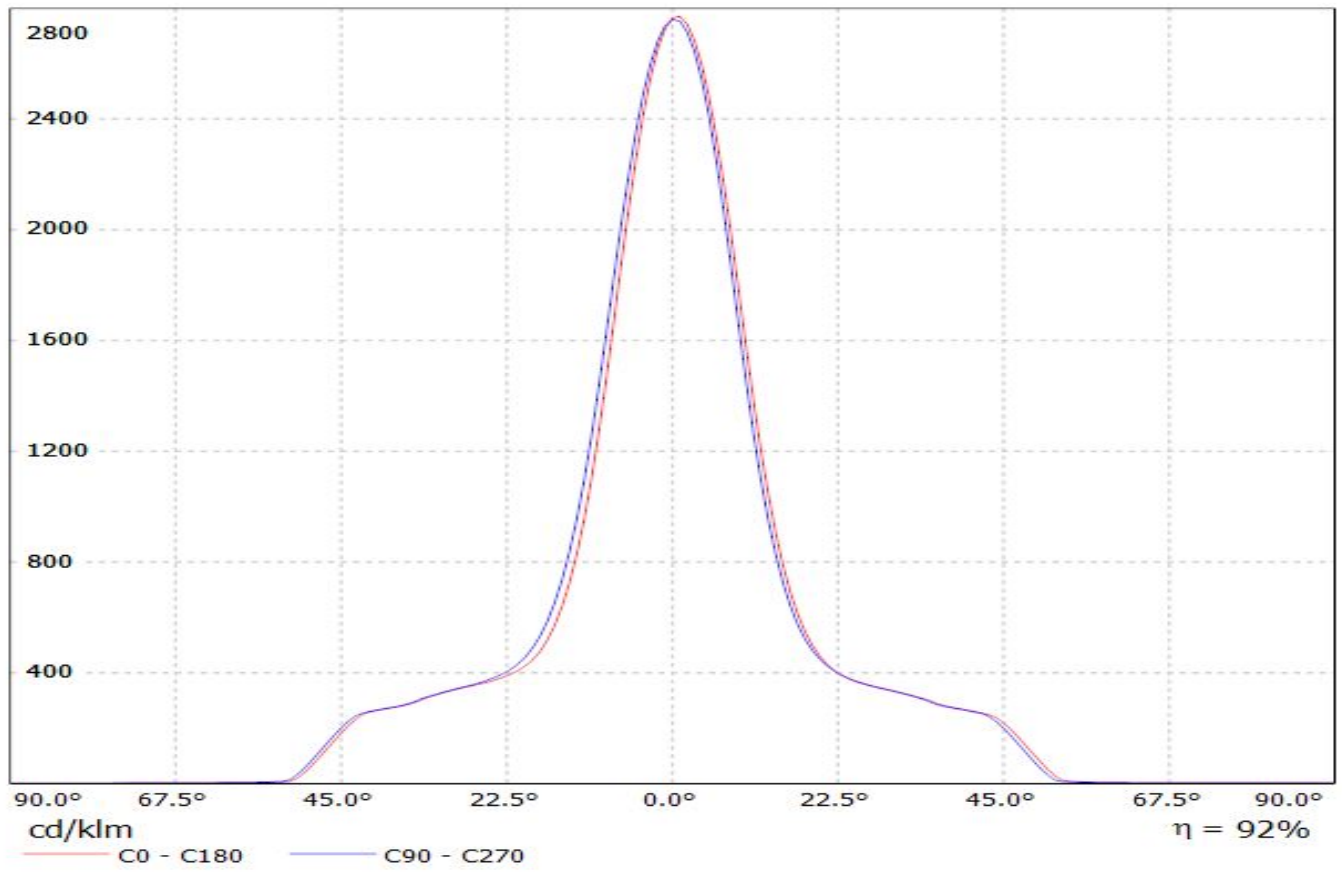

Luminaire: LEDiL Oy F13325_ANGELINA-S_(MEGAZENIGATA) Eff.93.7%
Lamps: 1 x SHARP_MEGAZENIGATA_(GW6DME30NFC)_1238.26lm@250mA_CCT=3000K_P=11.1211W_I=249.8mA

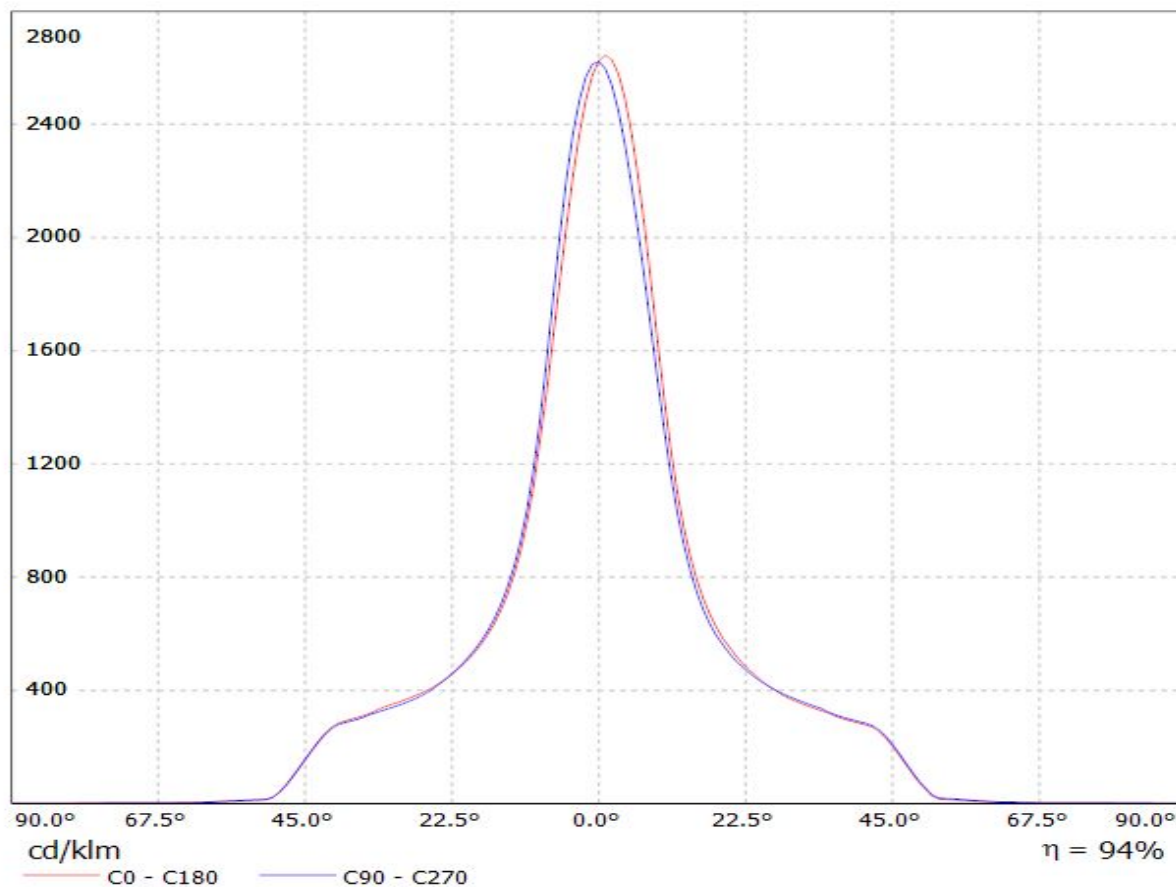

Luminaire: LEDiL Oy F13325_ANGELINA-S_(STARK_SLE_G2_LES19) Eff.92.2%
Lamps: 1 x TRIDONIC STARK SLE G2 LES19 830 CLA 964.643lm@250mA CCT=3000K P=8W I=250mA

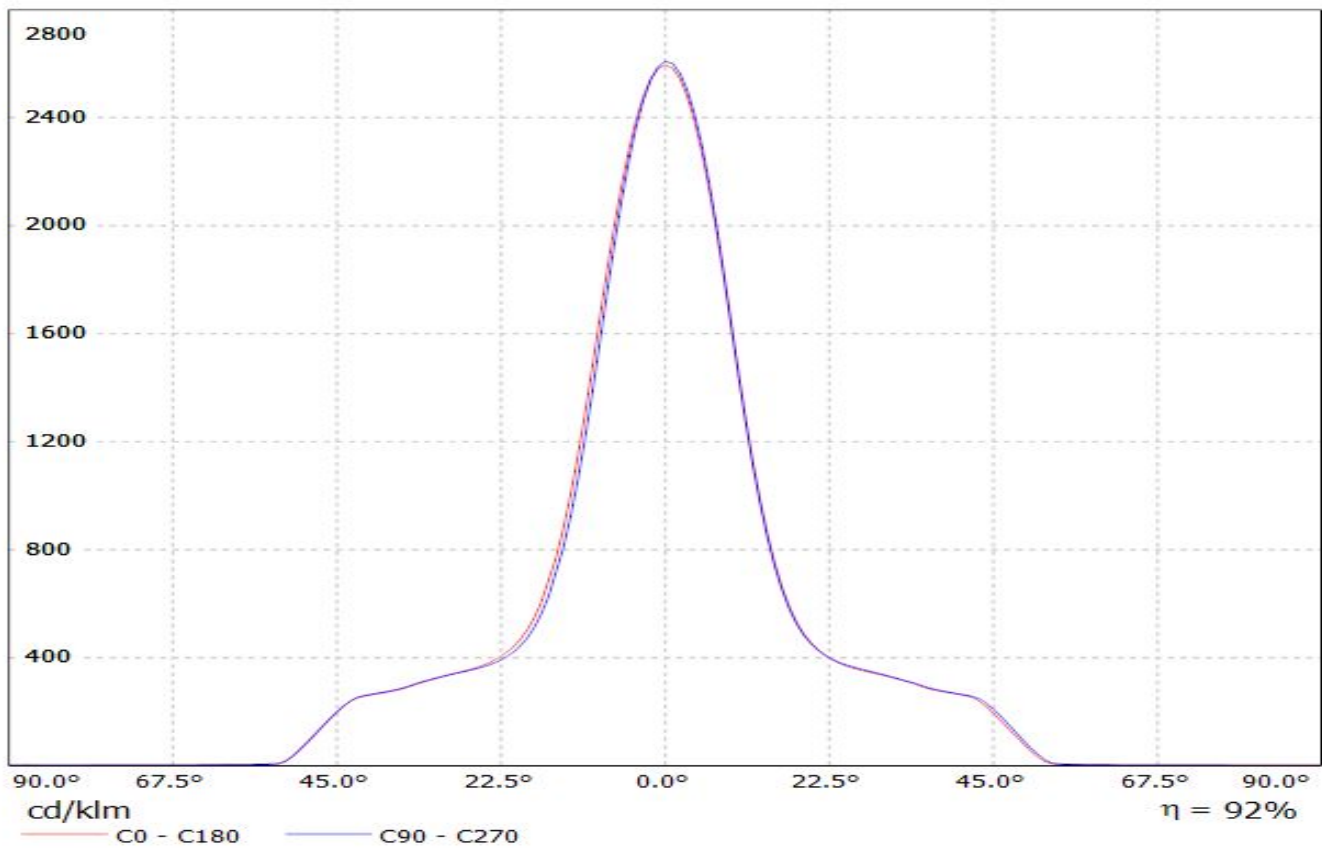

Luminaire: LEDiL Oy F13325_ANGELINA-S_(STARK_SLE_G2_LES23) Eff.90.5%
Lamps: 1 x TRIDONIC STARK SLE G2 LES23 830 CLA 982.731lm@250mA CCT=3000K P=8W I=250mA

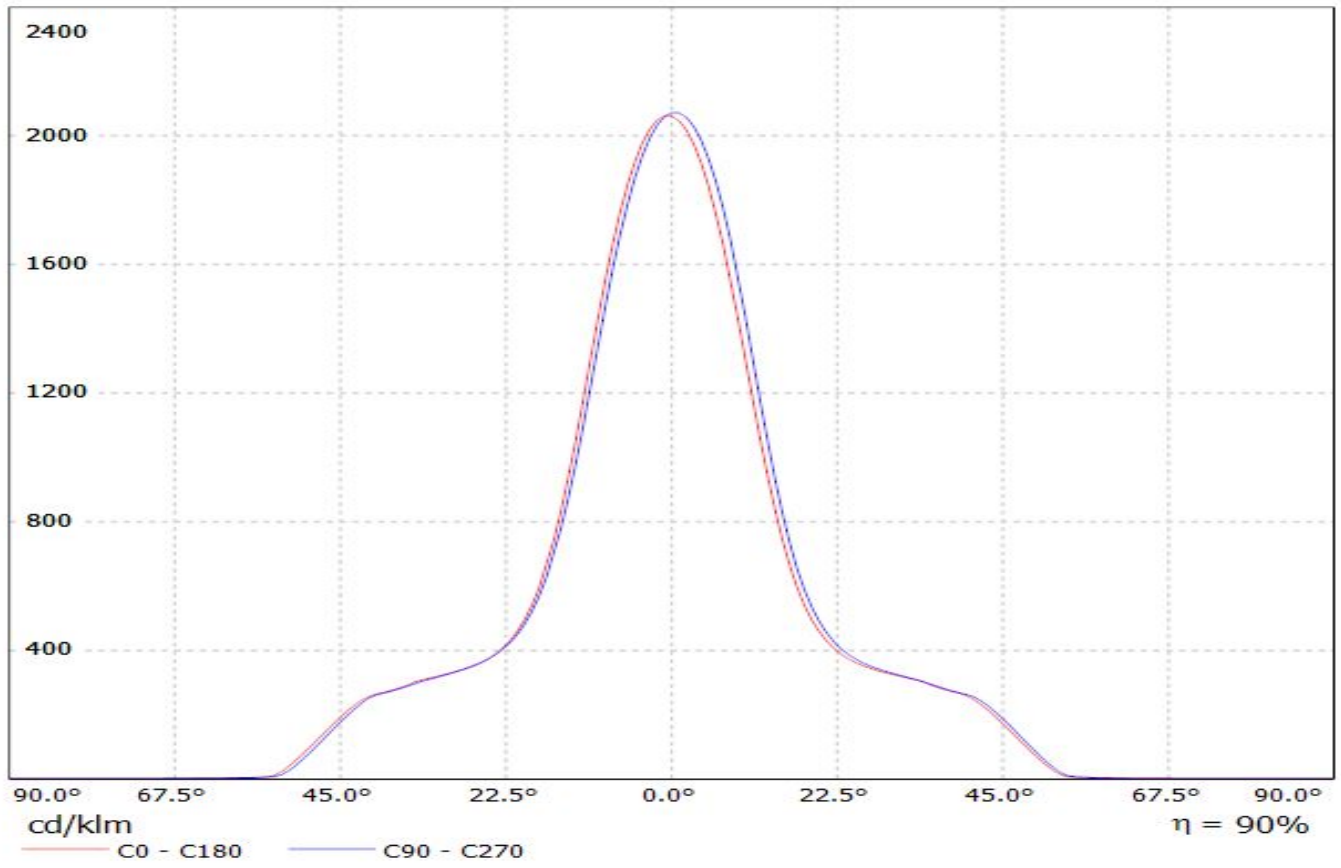

Luminaire: LEDiL Oy F13325_ANGELINA-S_(STARK_SLE_G2_LES26) Eff.89.2%
Lamps: 1 x TRIDONIC STARK SLE G2 LES26 830 CLA 1095.88lm@250mA CCT=3000K P=8W I=250mA

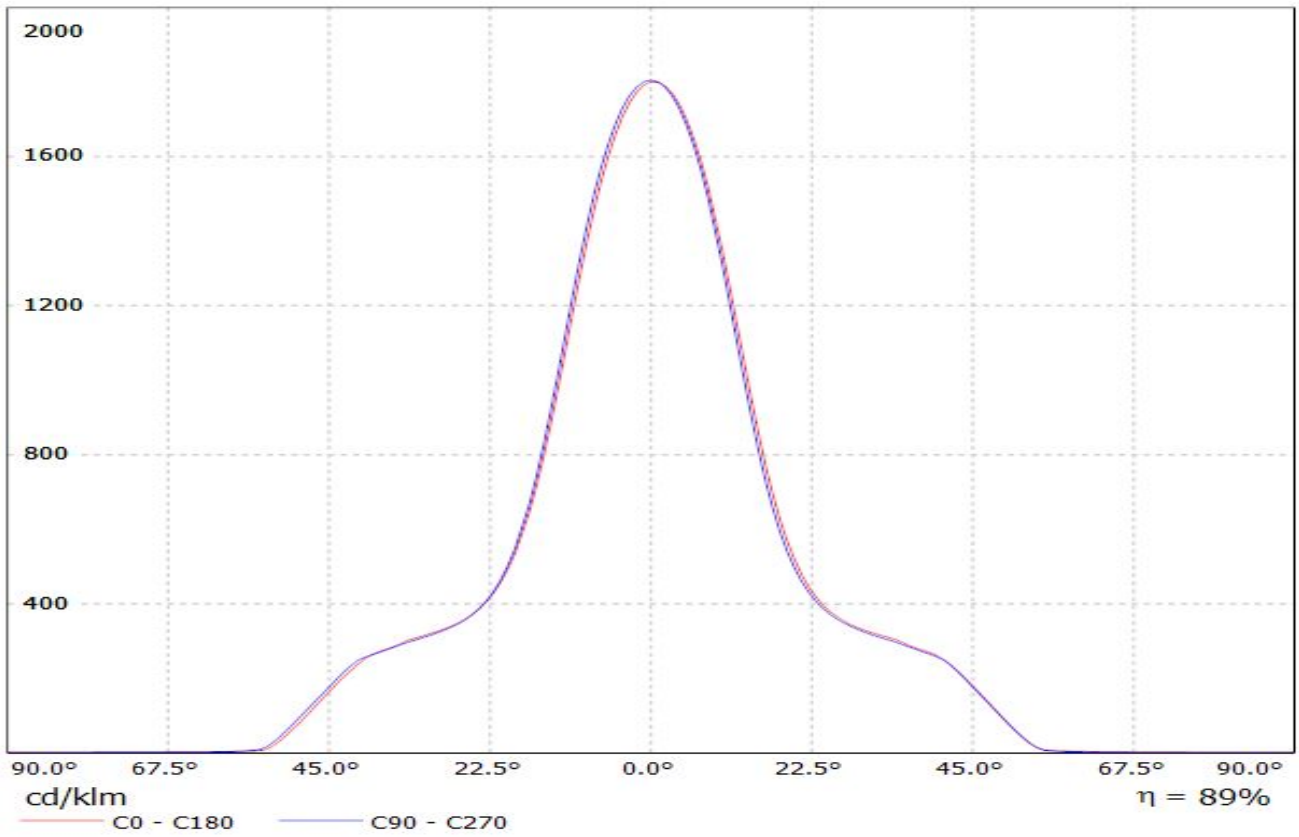

LEDiL Oy F13325_ANGELINA-S_(SLE_G3_LES19) Eff.93.5% / LDC (Linear)

Luminaire: LEDiL Oy F13325_ANGELINA-S_(SLE_G3_LES19) Eff.93.5%
Lamps: 1 x TRIDONIC_STARK_SLE_G3_LES19_(STARK-SLE-G3-LES19-2000-840-CLA)
_1058.33lm@250mA_P=8.32833W_I=249.8mA

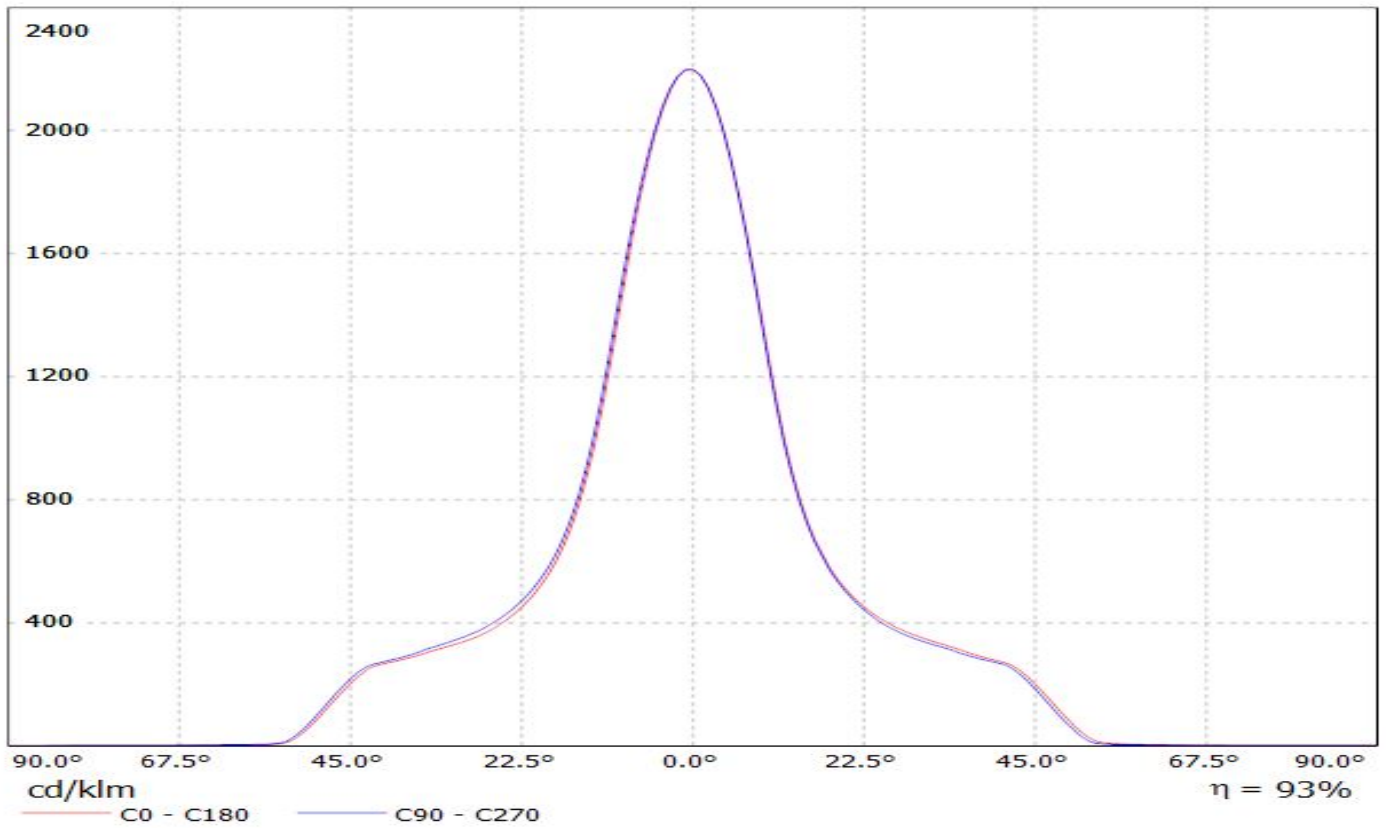

Luminaire: LEDiL Oy F13325_ANGELINA-S_(SLE_G3_LES23) Eff.91.2%

Lamps: 1 x TRIDONIC_STARK_SLE_G3_LES23_(STARK-SLE-PURE_G3-23-3000-930-SEL)_813.196lm@250mA_CCT=3000K_P=8.20018W_I=249.8mA

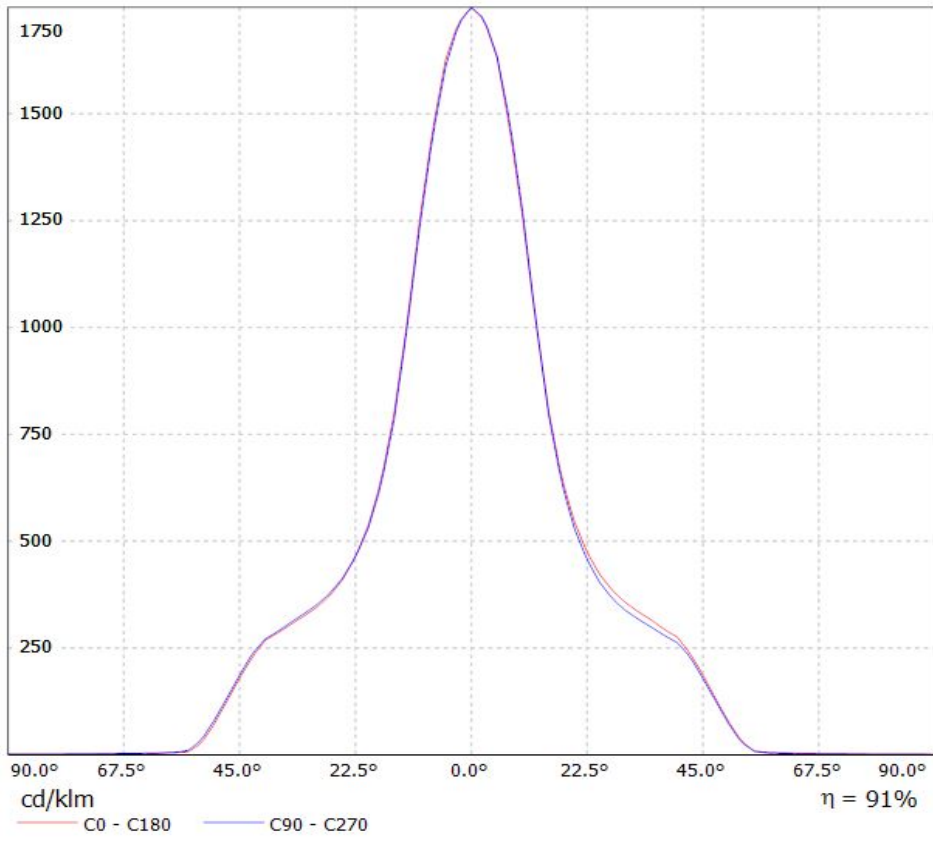

Luminaire: LEDiL Oy F13325_ANGELINA-S (SLE_G4_LES23)

Lamps: 1 x Tridonic_SLE_G4_LES23_1354.57lm@250mA_P=8.18744W_I=0.2498A

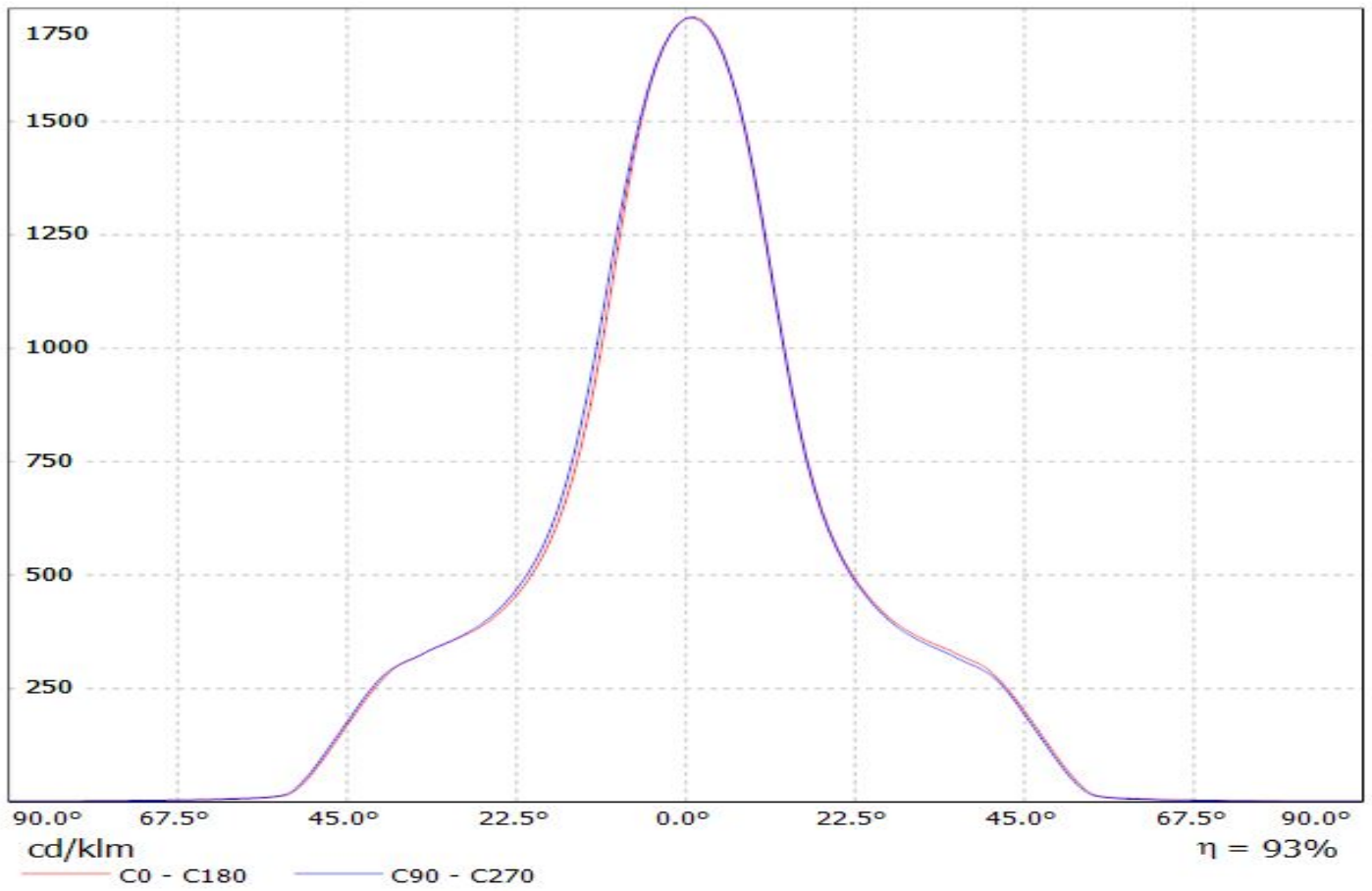

Luminaire: LEDiL Oy F13325_ANGELINA-S (SLE GEN4 LES19)
Lamps: 1 x SLE GEN4 LES19_1227.01lm@250mA_P=8.21492W_I=0.2498A

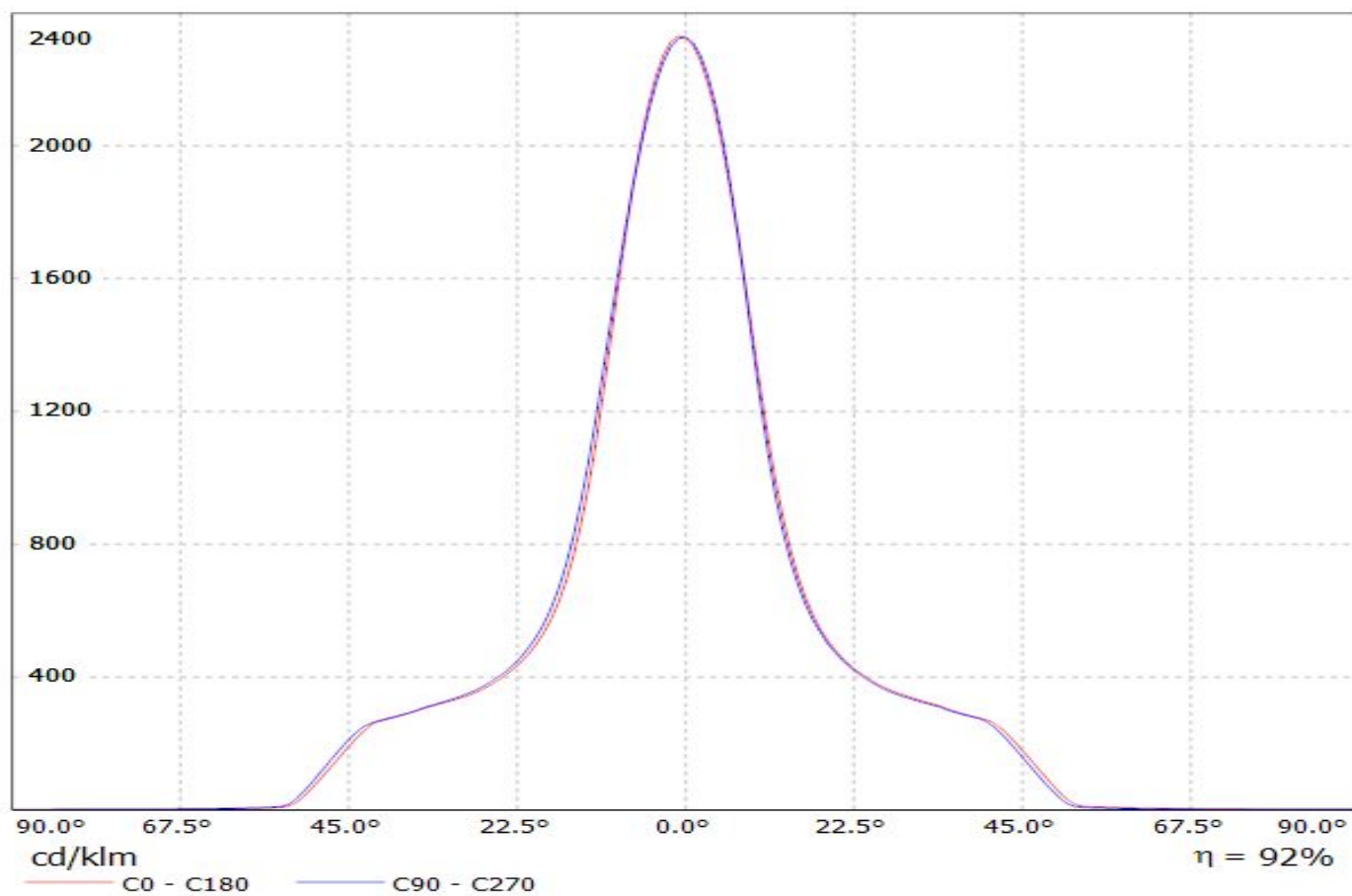

Luminaire: LEDiL Oy F13325_ANGELINA-S_(SLE-G5_LES-15)
Lamps: 1 x Tridonic_SLE-G5_LES-15_1238lm@250mA_P=8.6575W_I=0.250A

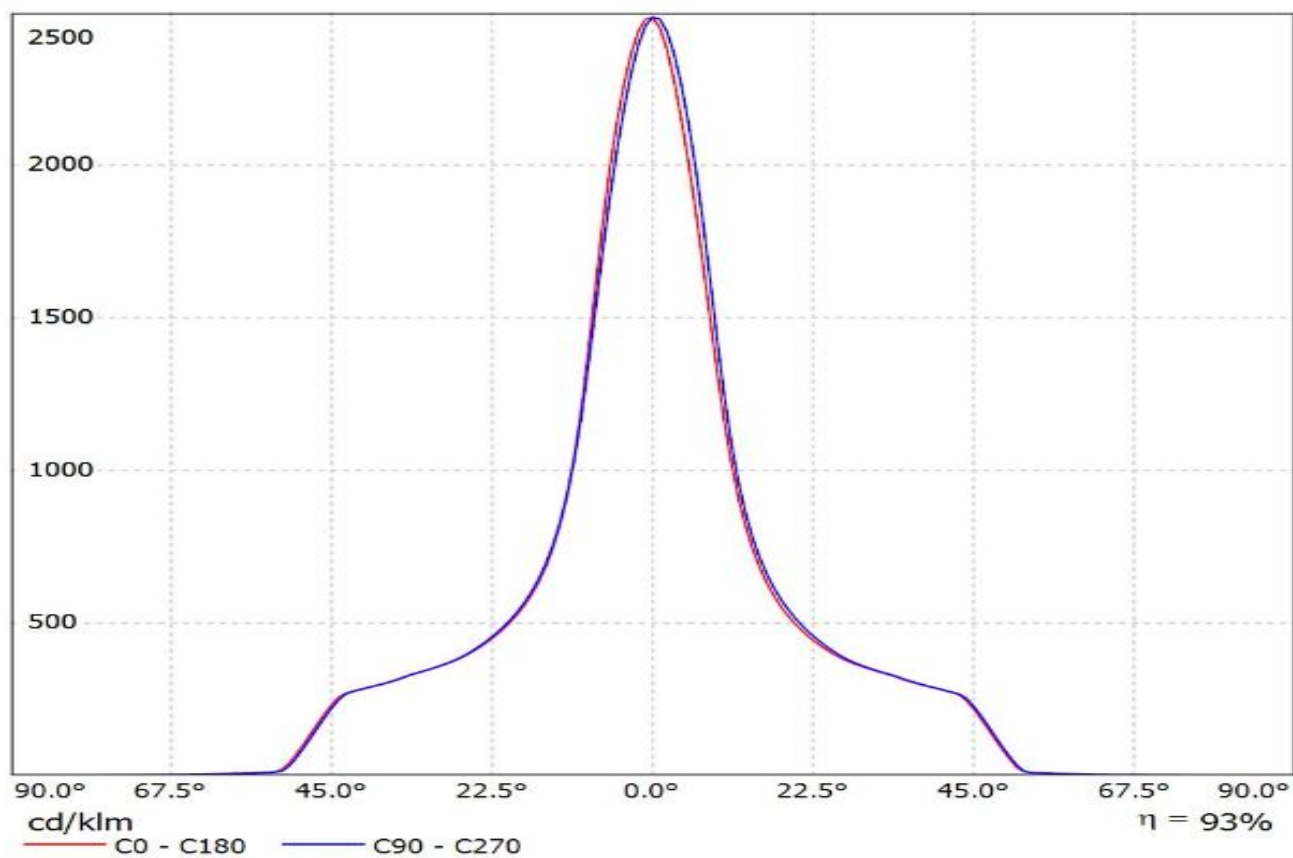

Luminaire: LEDiL Oy F13325_ANGELINA-S_(SLE-G5_LES-19)
Lamps: 1 x Tridonic_SLE-G5_LES-19_1287.79lm@250mA_P=8.2274W_I=0.250A

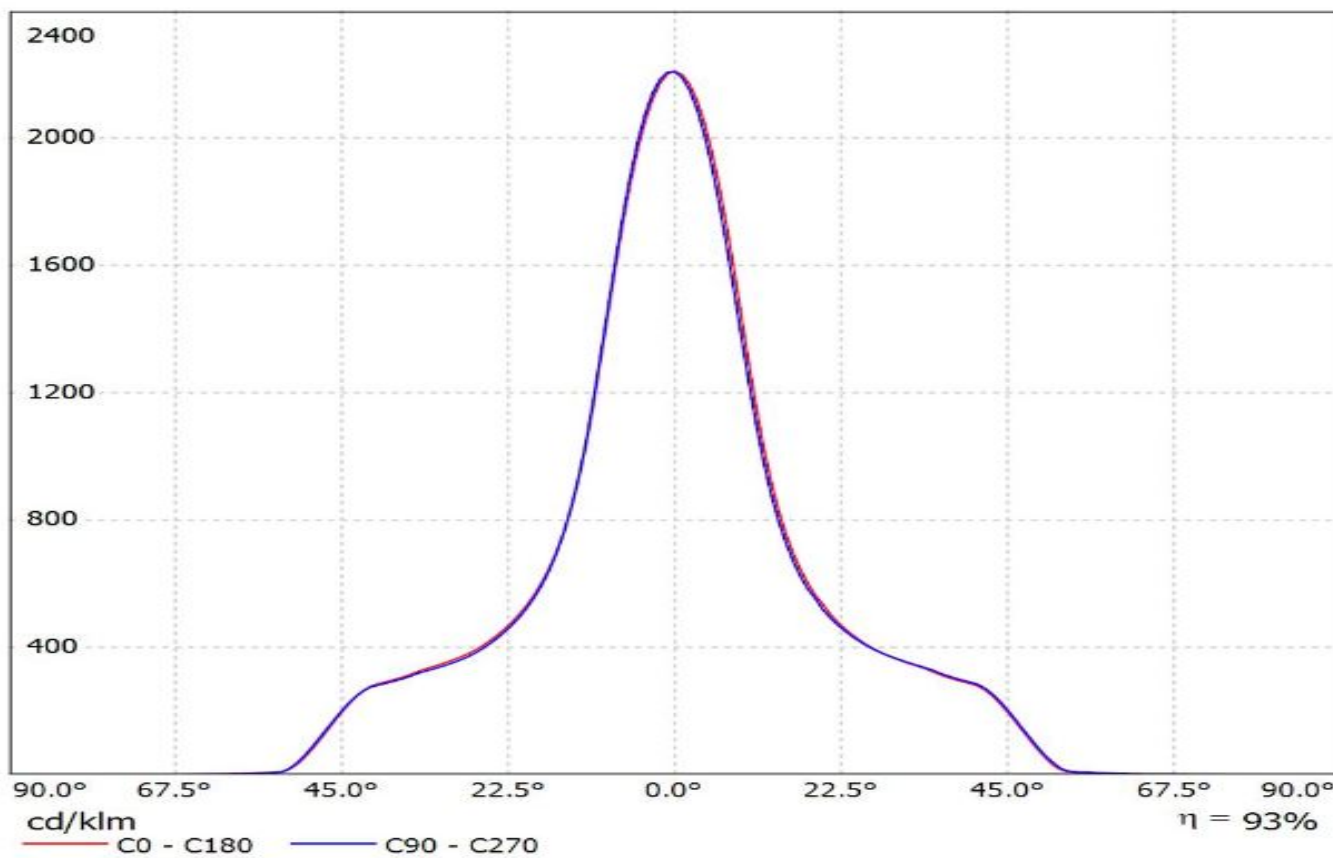

Luminaire: LEDiL Oy F13325_ANGELINA-S_(SLE-G5_LES-23)
Lamps: 1 x Tridonic_SLE-G5_LES-23_1303.96lm@250mA_P=8.1062W_I=0.250A

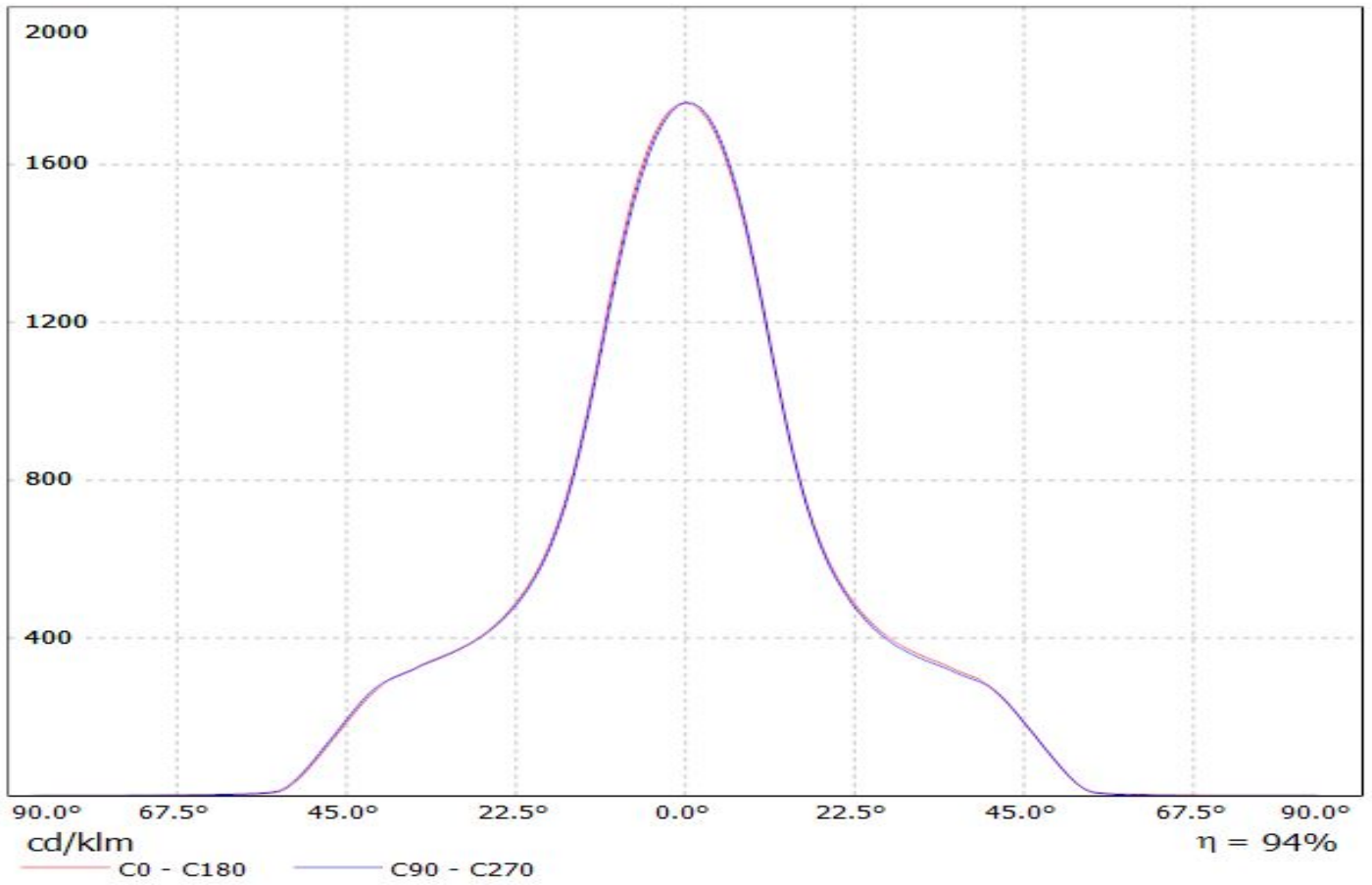

Luminaire: LEDiL Oy F13325_ANGELINA-S_(WU-M-461-827)

Lamps: 1 x Vossloh_WU-M-461-827_771.829lm@250mA_P=6.26998W_I=249.8mA

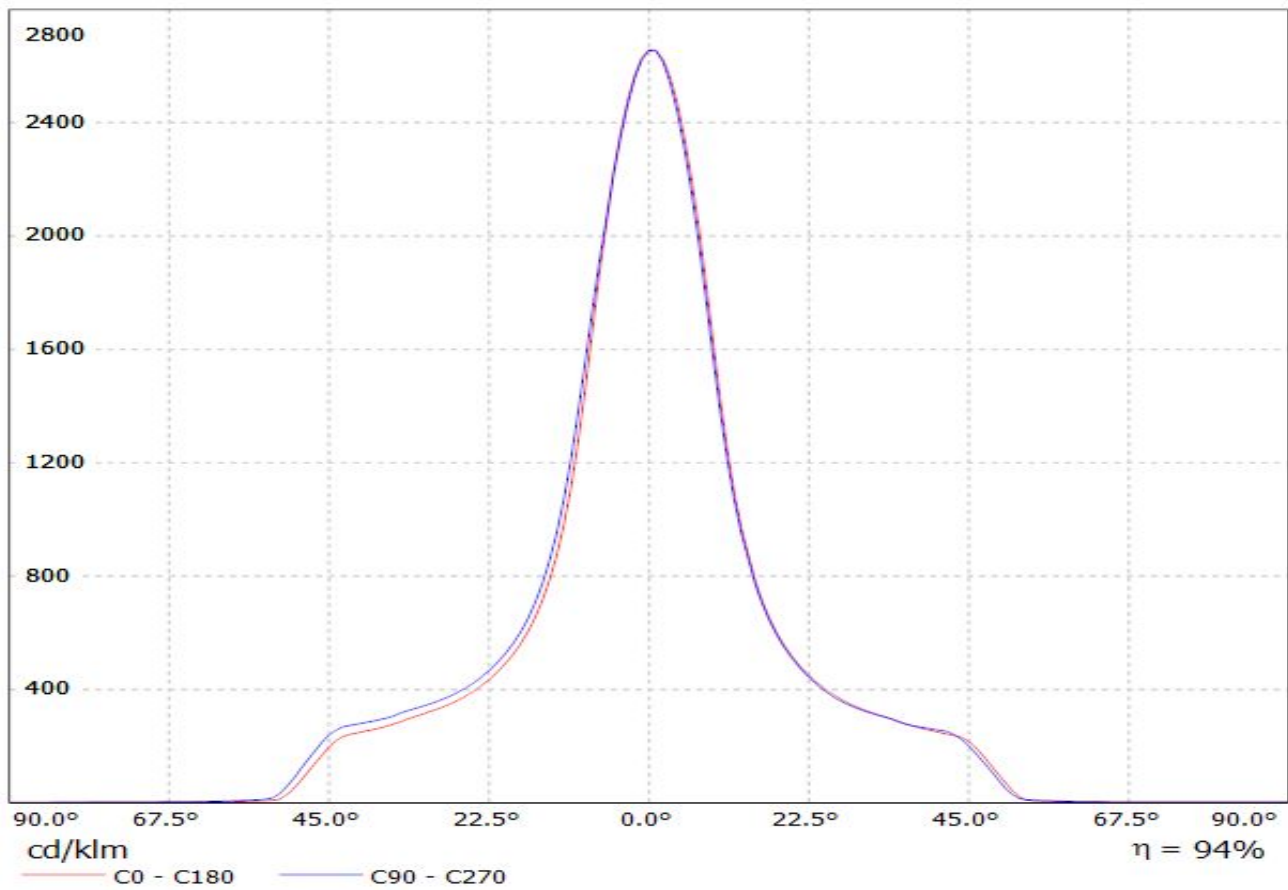

Luminaire: LEDiL Oy F13325_ANGELINA-S_(WU-M-462-827)
Lamps: 1 x Vossloh_WU-M-462-827_1116.7lm@250mA_P=8.9943W_I=249.8mA

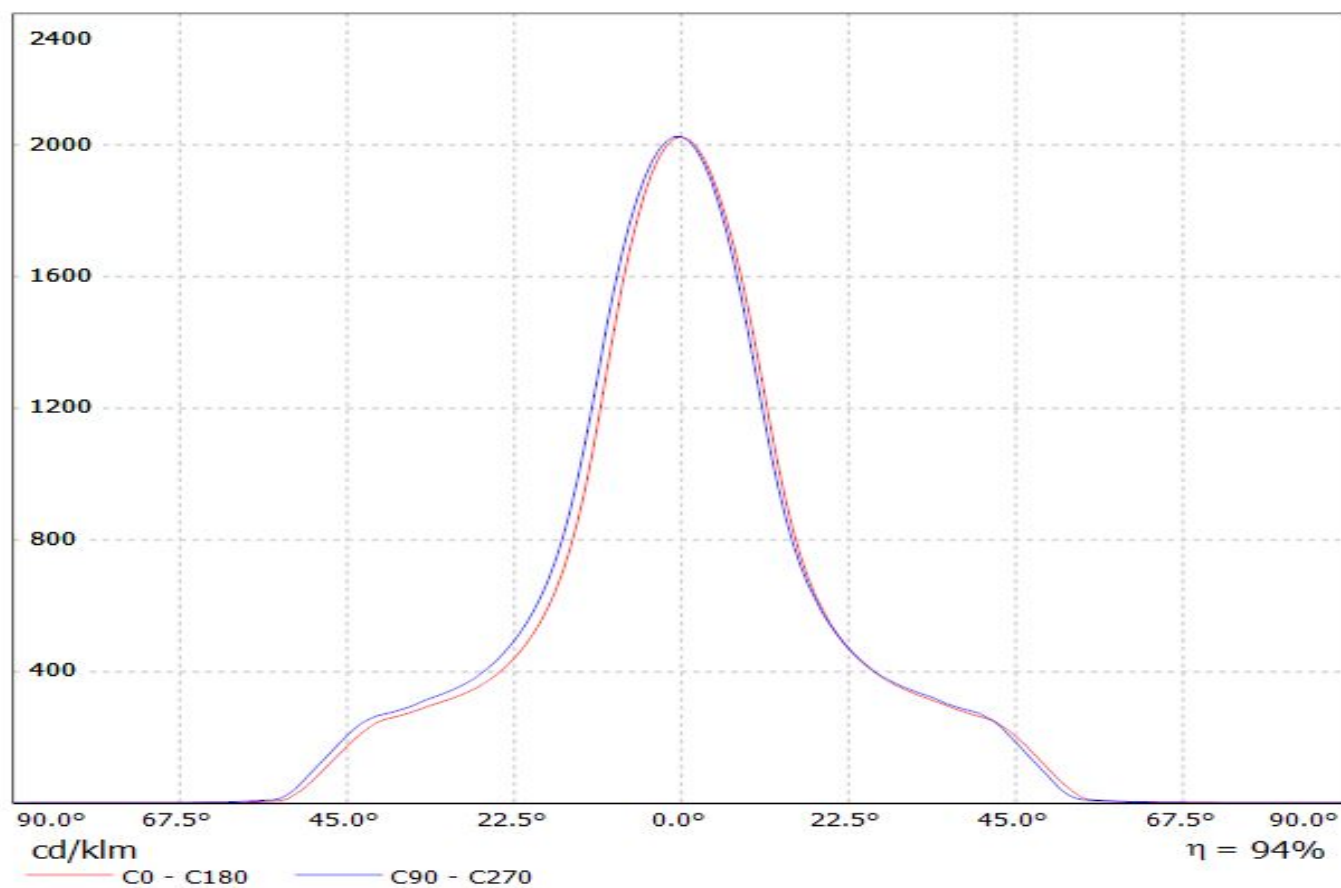

Luminaire: LEDiL Oy F13325_ANGELINA-S_(WU-M-464-827)

Lamps: 1 x Vossloh_WU-M-464-827_1452.93lm@250mA_P=11.6939W_I=249.8mA

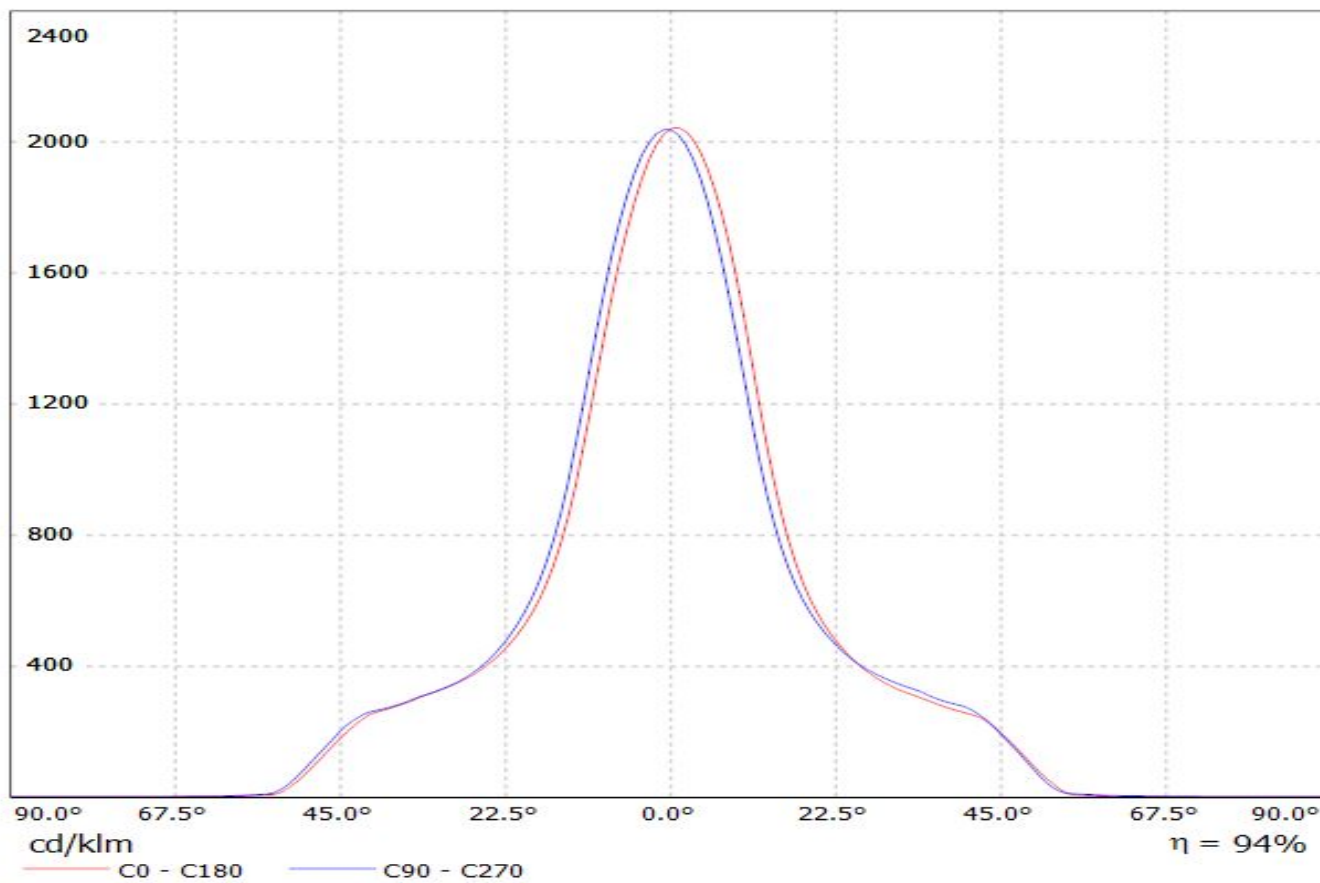

Luminaire: LEDiL Oy F13325_ANGELINA-S_(WU-M-484)

Lamps: 1 x Vossloh_Schwabe-WU-M-484_(WU-M-484-830)_657.721lm@250mA_P=5.59451W_I=249.9mA

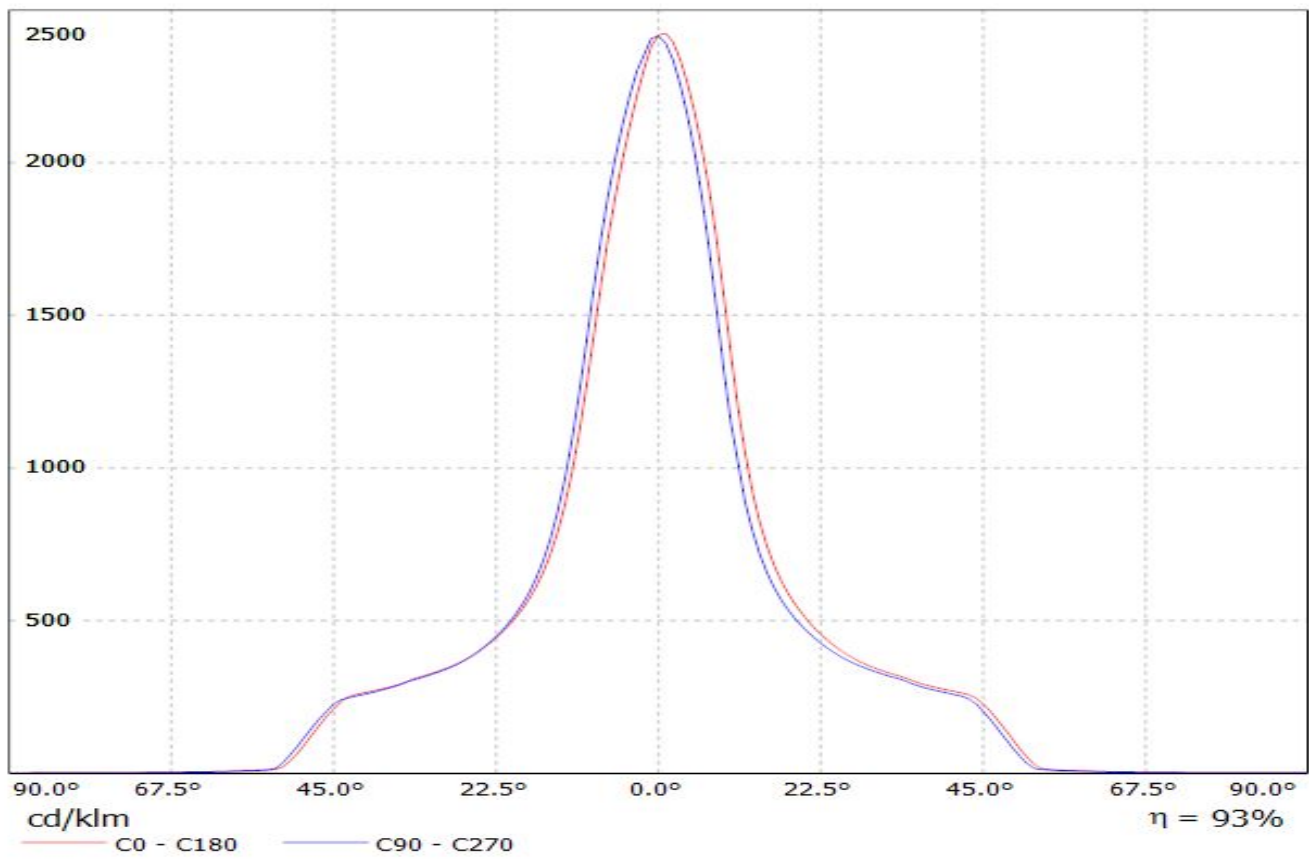

Luminaire: LEDiL Oy F13325_ANGELINA-S_(WU-M-485)

Lamps: 1 x Vossloh_Schwabe-WU-M-485_(WU-M-485-830)_1209.62lm@250mA_P=8.43849W_I=249.8mA

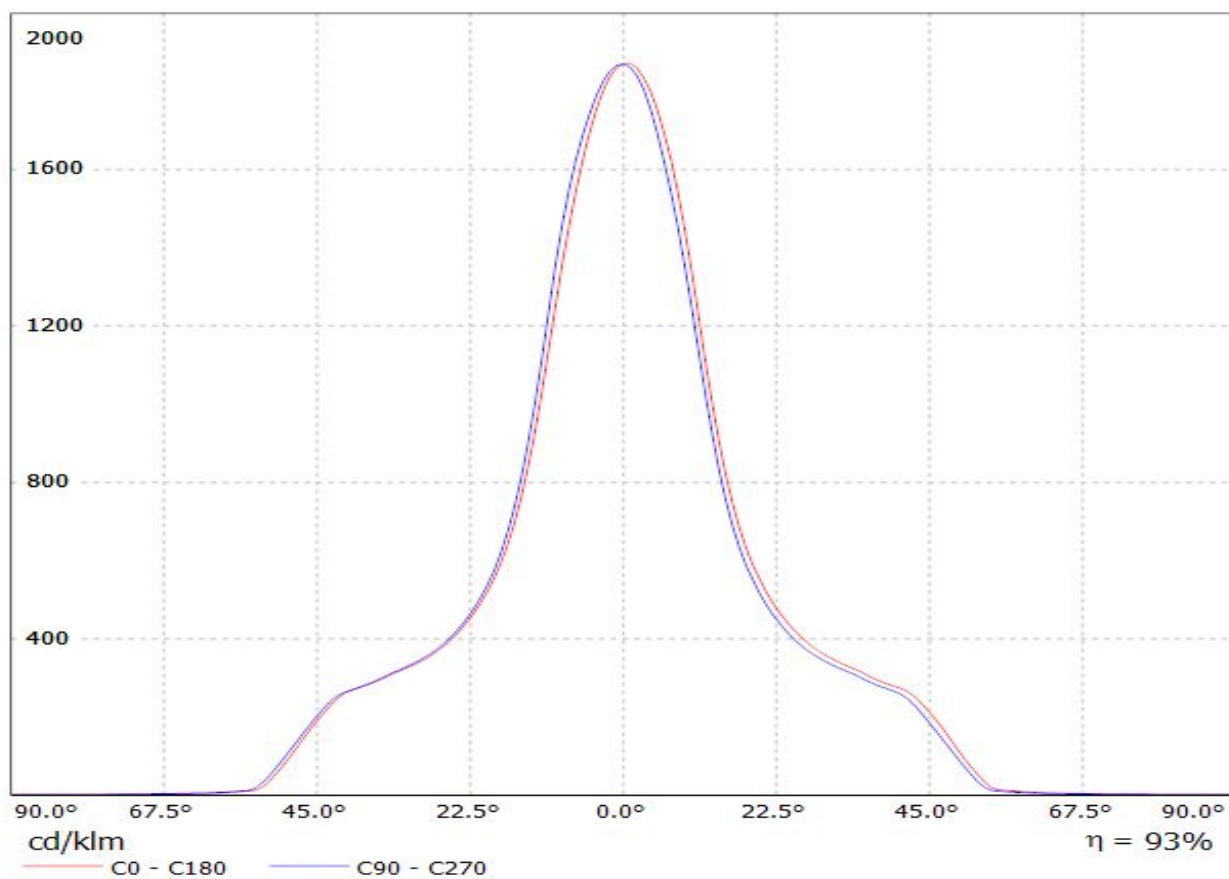

Luminaire: LEDiL Oy F13325_ANGELINA-S_(WU-M-486) Eff.93.3%
Lamps: 1 x Vossloh_Schwabe-WU-M-486_(WU-M-486-830)
_1474.55lm@250mA_P=10.4456W_I=249.8mA

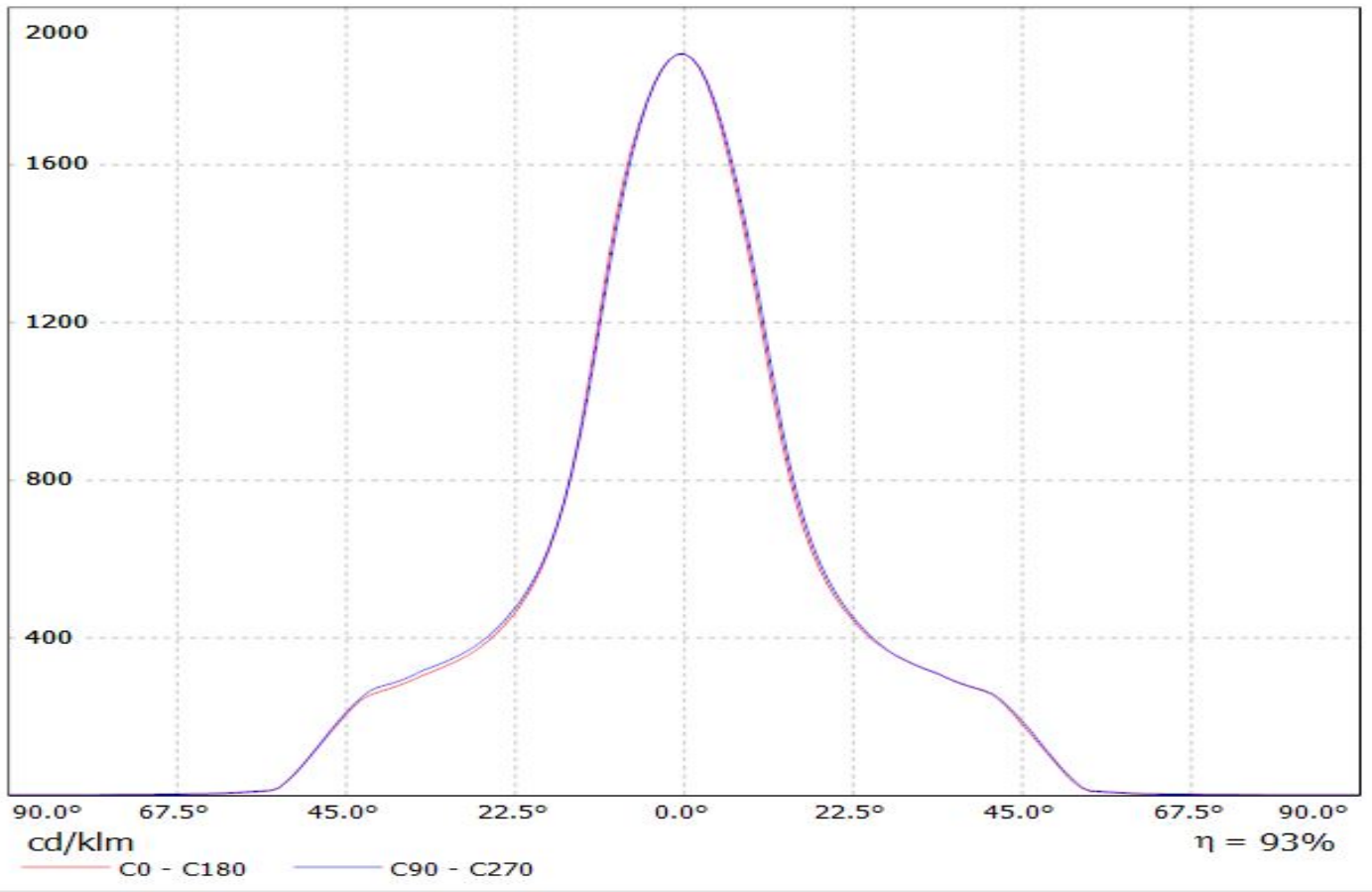

Luminaire: LEDiL Oy F13325_ANGELINA-S_(BXRA_ES) Eff.93.8%

Lamps: 1 x BXRA_ES_(BXRA-W1203_102820-3110)_281.549lm@250mA_P=4.09397W_I=249.8mA

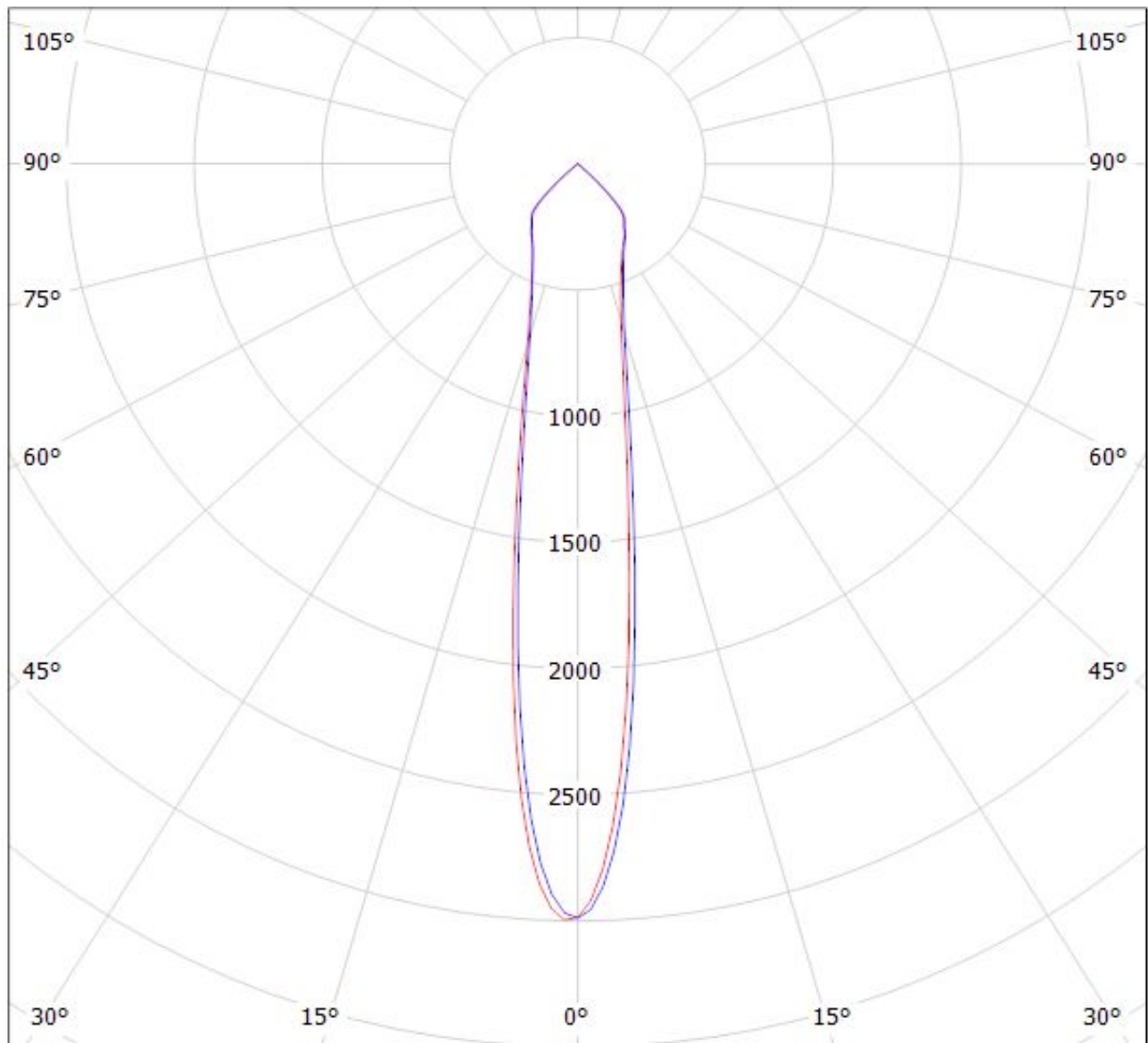

cd/klm

— C0 - C180

— C90 - C270

$\eta = 94\%$

Luminaire: Ledil F13325_ANGELINA-S_(V22+IDEAL)
Lamps: 1 x Bridgelux_V22_(BXRE30E6500H-Y2)_+50-2204CT_+_50-2100AN_1193.54lm@250mA_CCT=3000K_P=8.0988W_I=0.25A

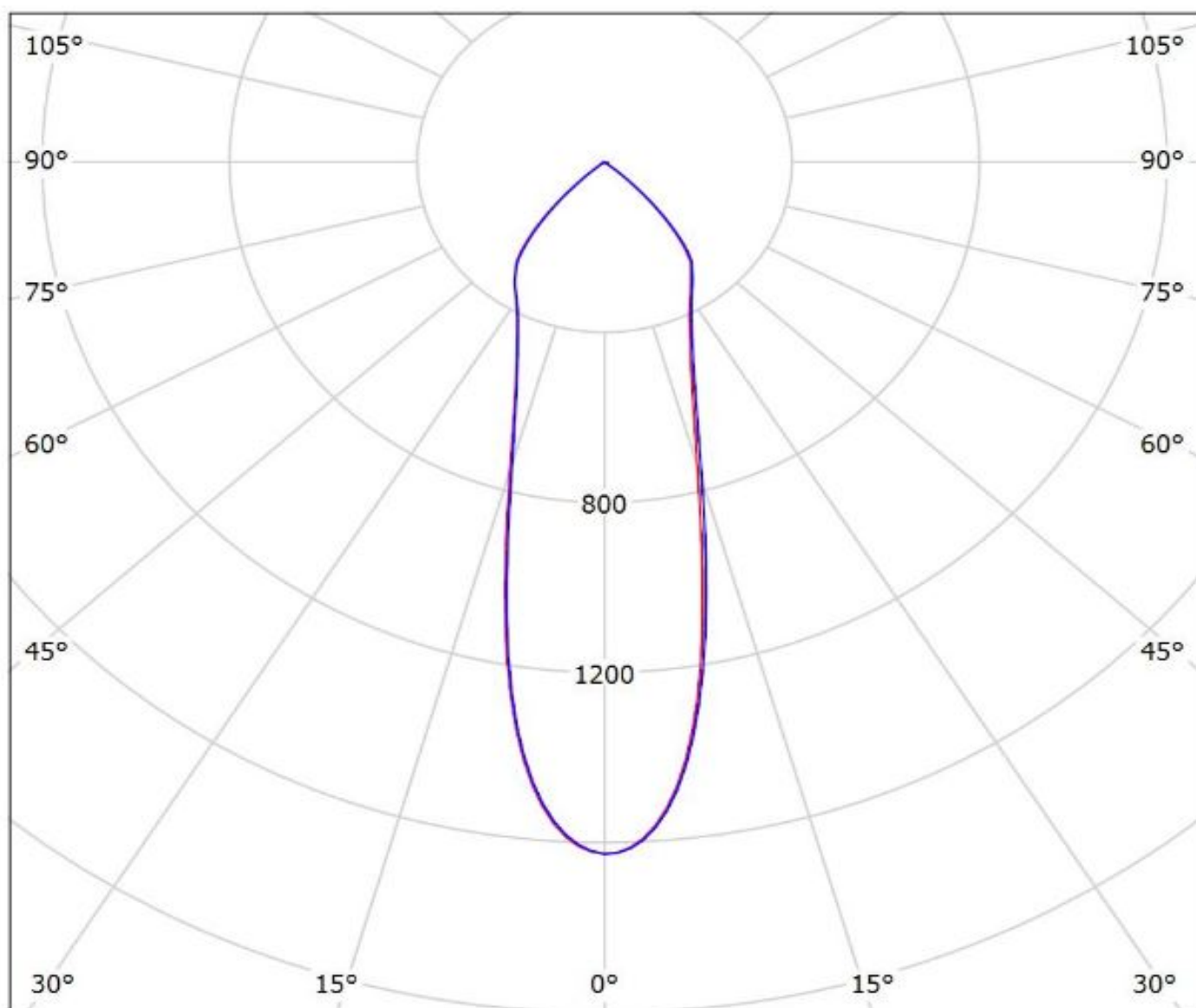

cd/klm

— C0 - C180 — C90 - C270

$\eta = 92\%$

Luminaire: LEDiL Oy F13325_ANGELINA-S_(V13_Gen7)+TE

Lamps: 1 x Bridgelux_V13_Gen7_(BXRE-30E2000-B_+TE_2213254-2+TE_2213194-1)_1295.55lm@250mA_P=8.30985W_I=0.25A

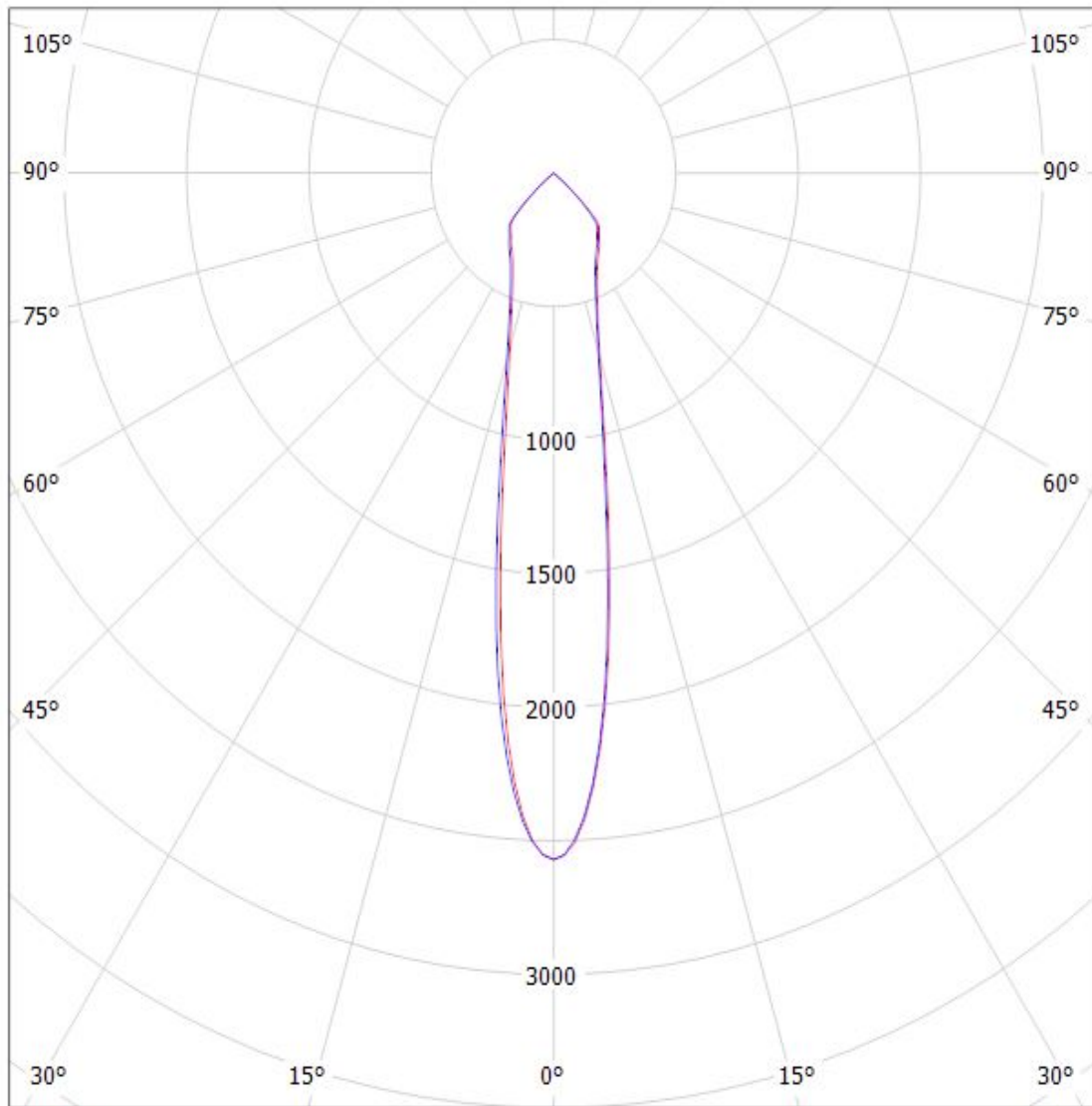

cd/klm

— C0 - C180

— C90 - C270

$\eta = 93\%$

Luminaire: Ledil Oy F13325_ANGELINA-S_Bridgelux_V22_Gen7_SIMULATED F13325_ANGELINA-S_Bridgelux_V22_Gen7_SIMULATED
Lamps: 1 x F13325_ANGELINA-S_Bridgelux_V22_Gen7_SIMULATED

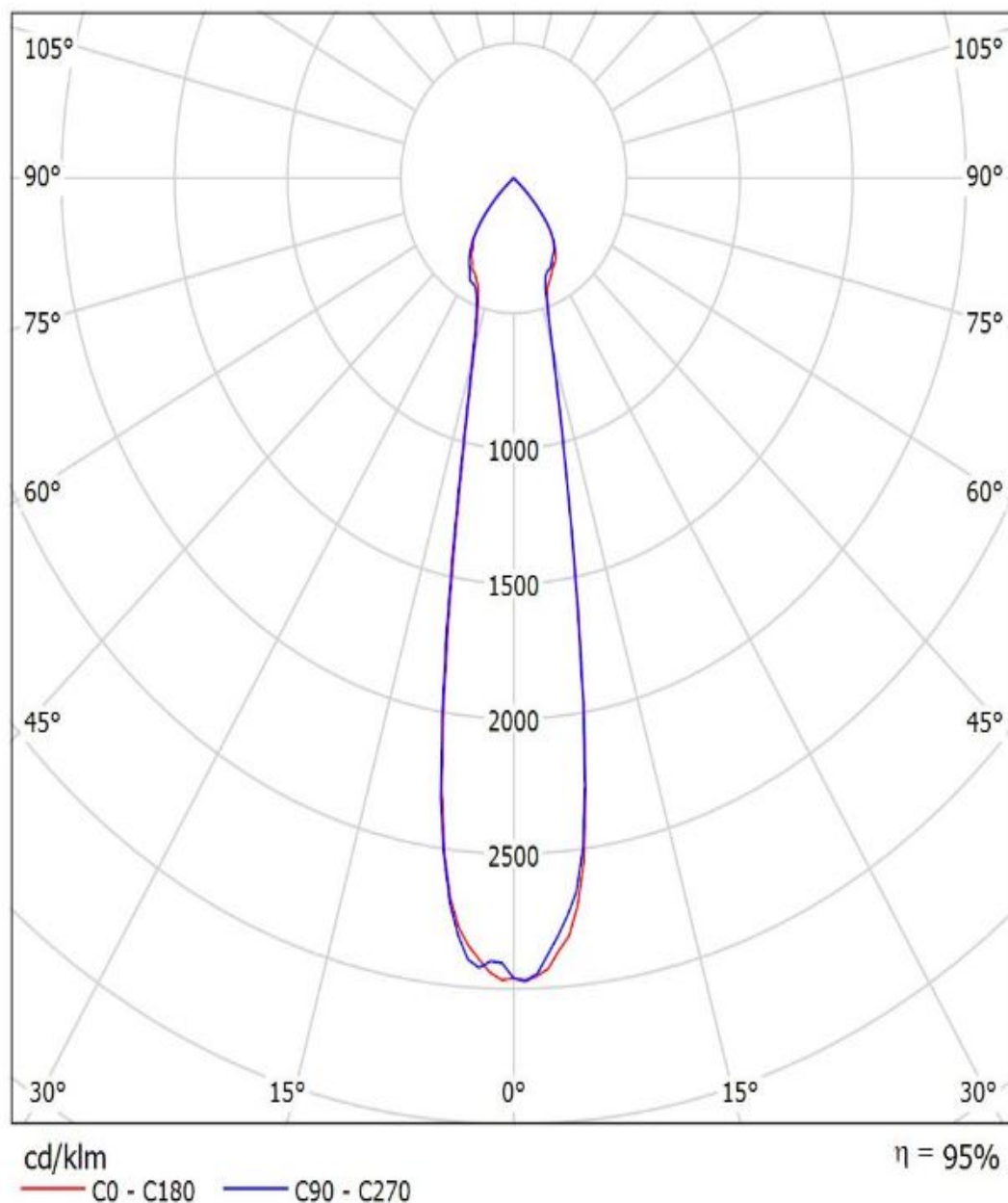

Luminaire: LEDiL Oy F13325_ANGELINA-S_(CLL030) Eff.93.6%

Lamps: 1 x CITIZEN_CLL030_(CLL030-1205A5-303H1A7)_758.588lm@250mA_CCT=5090K_P=8.61086W_I=249.8mA

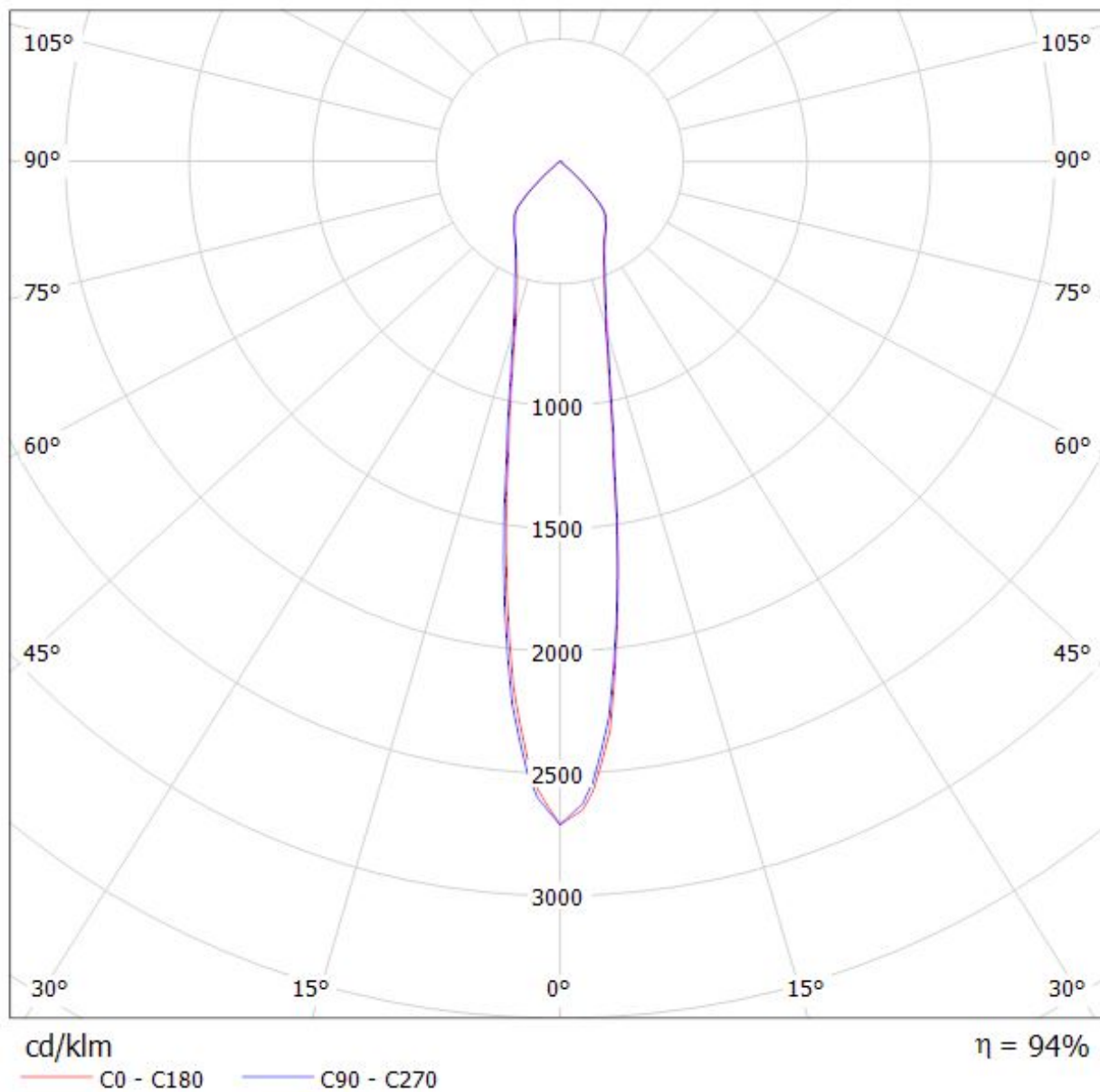

Luminaire: LEDiL F13325_ANGELINA-S_(CLL030)

Lamps: 1 x Citizen CLL030 740lm@250mA (CLL030-1205A5-303H1A7) CCT:3000K

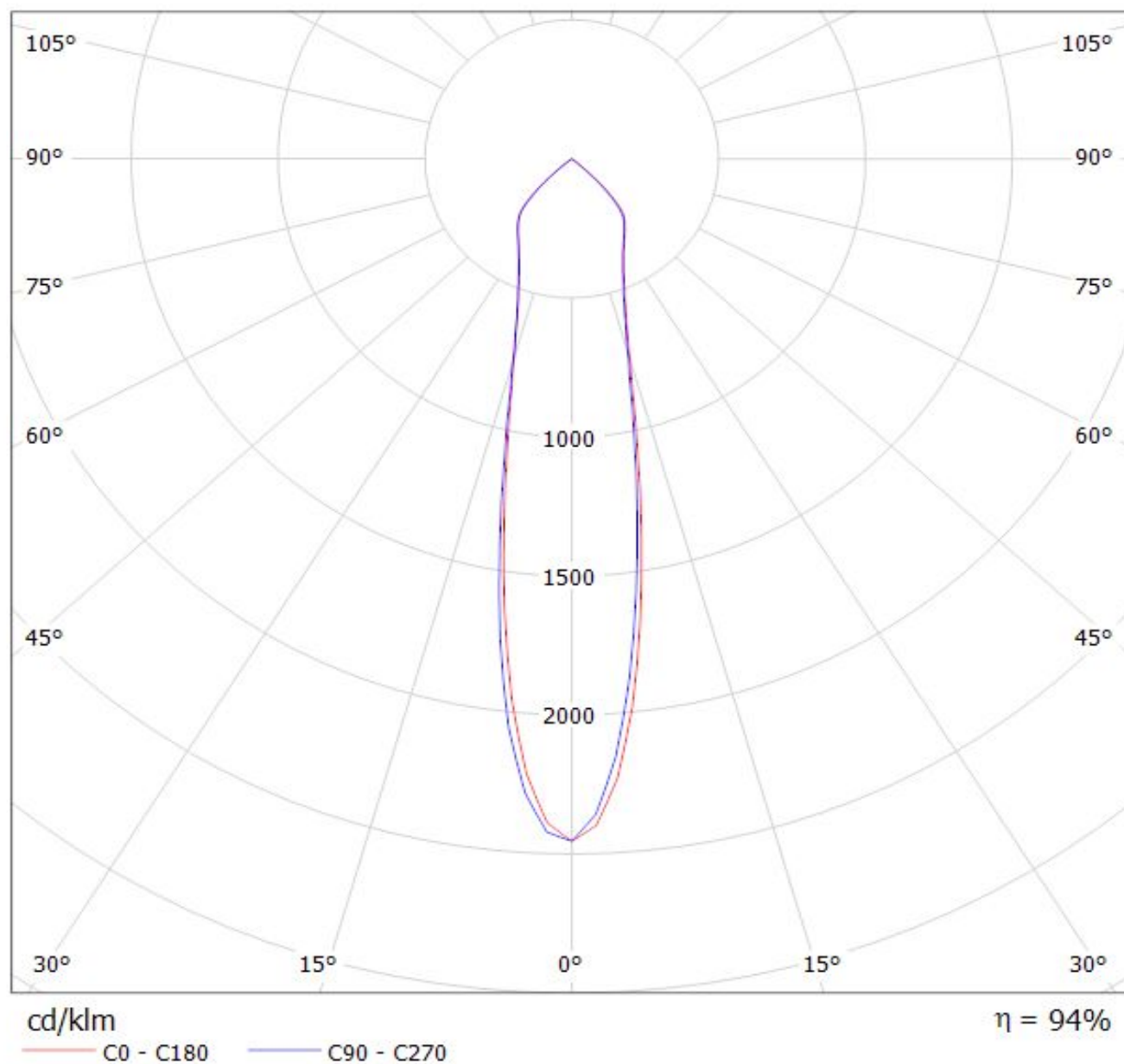

Ledil F13325_ANGELINA-S_(CLU720) / LDC (Polar)

Luminaire: Ledil F13325_ANGELINA-S_(CLU720)
Lamps: 1 x CITIZEN_CLU720_(CLU720-1206B8-273M2)
_1340.38lm@250mA_CCT=2700K_P=8.35W_I=0.25A

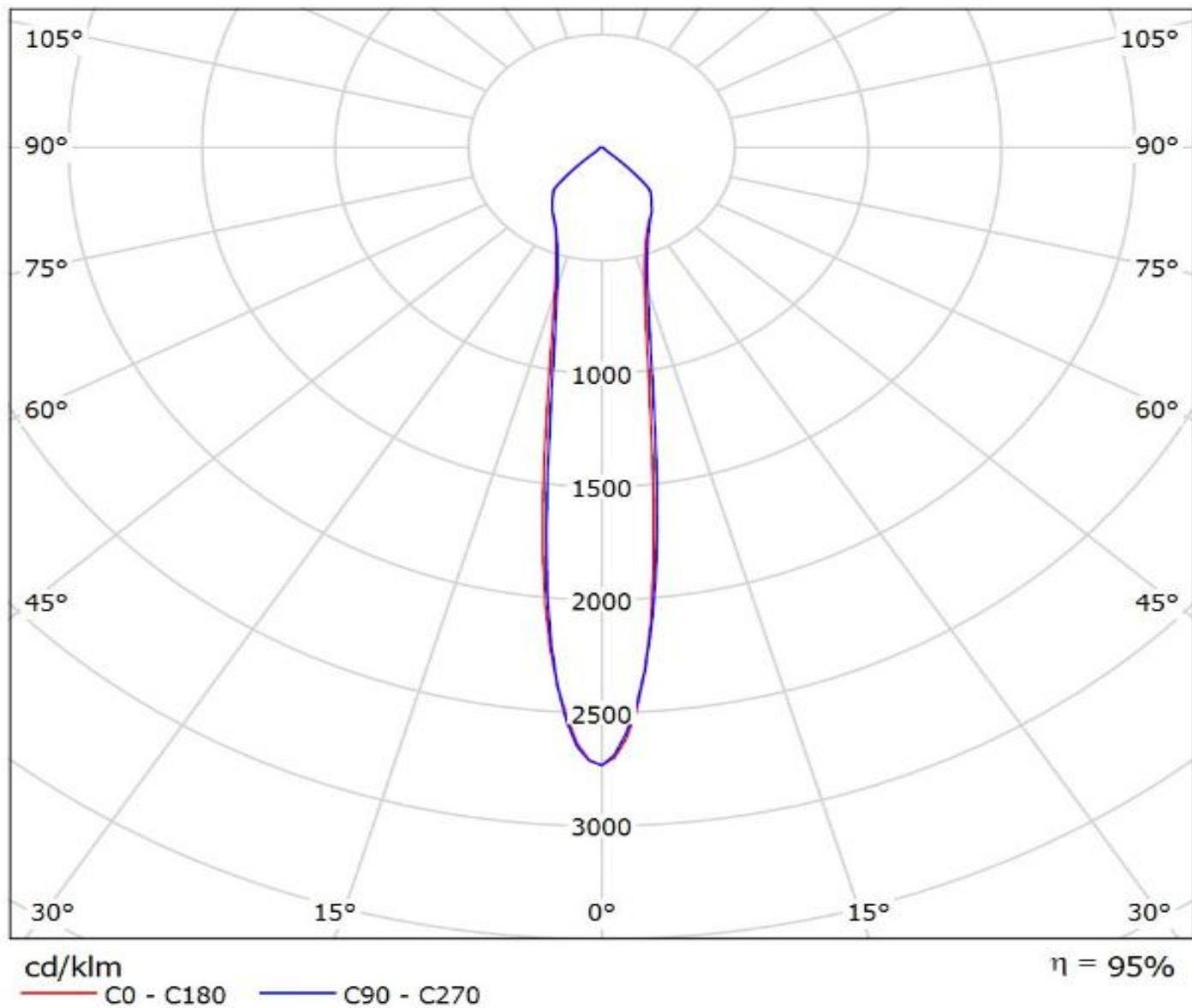

Luminaire: Ledil F13325_ANGELINA-S_(CLU720)
Lamps: 1 x CITIZEN_CLU720_(CLU720-1206B8-273M2)
_1337.27lm@250mA_CCT=2700K_P=8.35W_I=0.25A

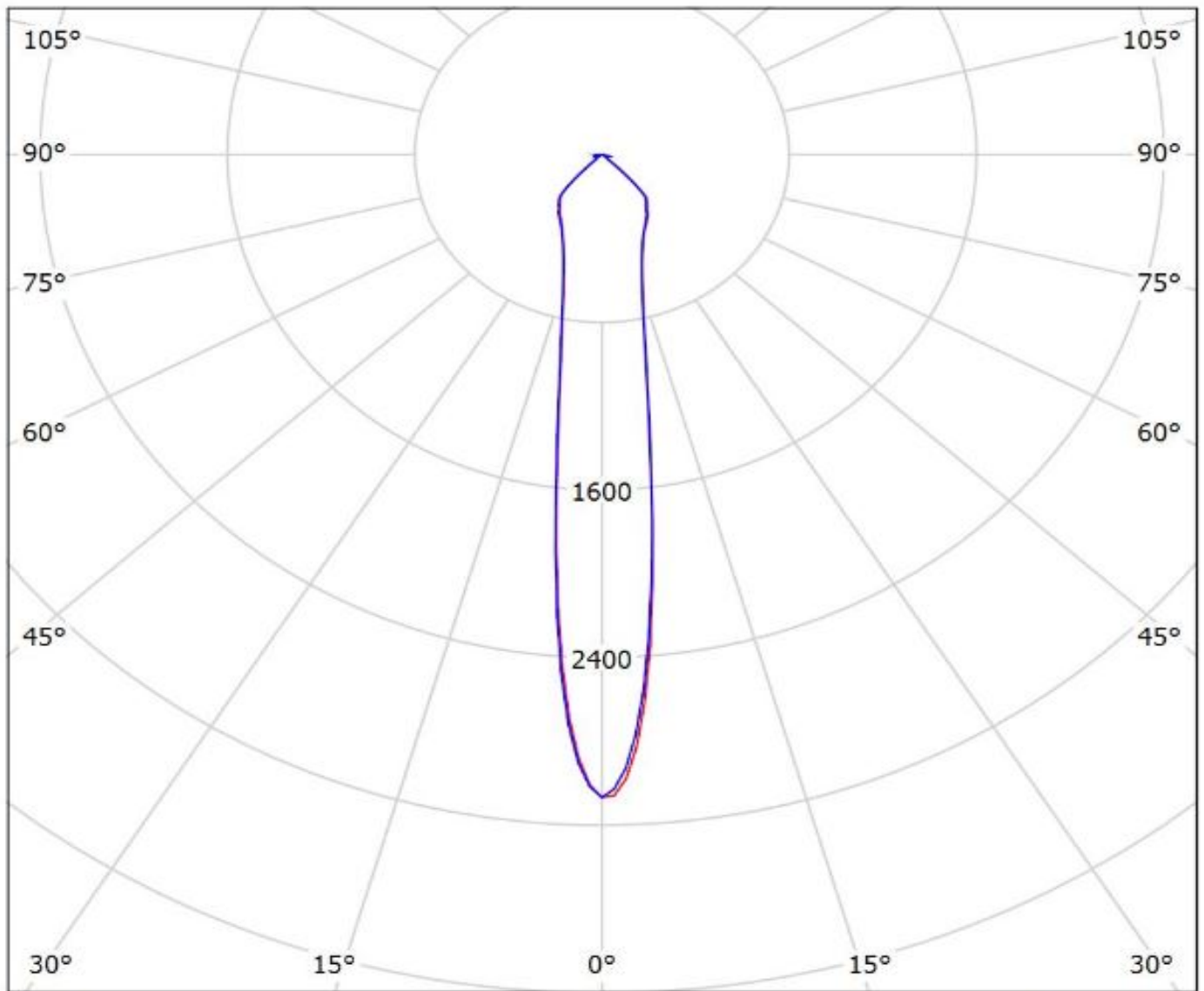

cd/klm

— C0 - C180 — C90 - C270

$\eta = 95\%$

Luminaire: Ledil F13325_ANGELINA-S_(CLU046+IDEAL)

Lamps: 1 x Citizen_CLU046_(-1212C1-303M2G2)_1383.92lm@250mA_CCT=3000K_P=8.122W_I=0.25A

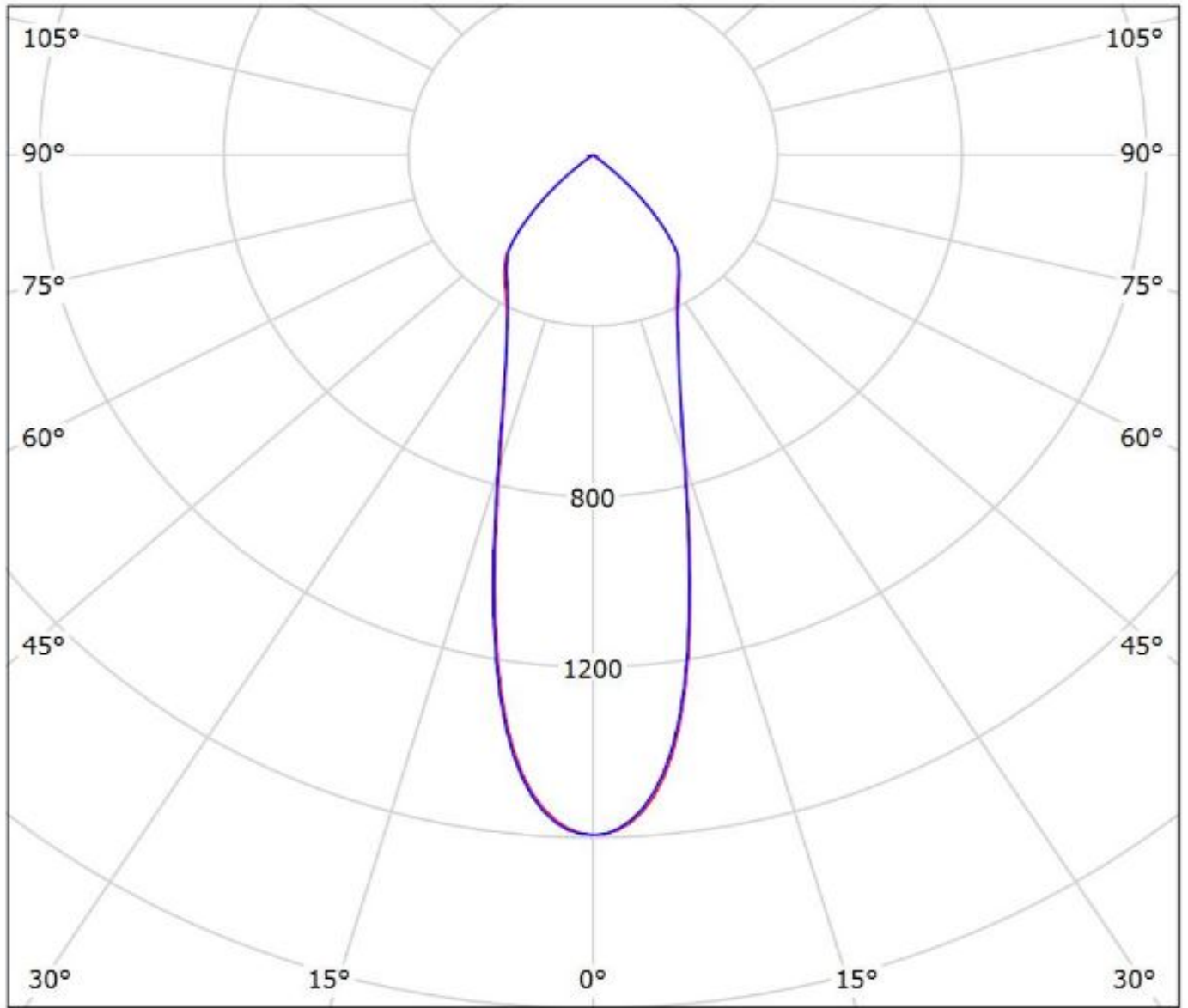

cd/klm

— C0 - C180

— C90 - C270

$\eta = 92\%$

Luminaire: Ledil F13325_ANGELINA-S_(CLU730+IDEAL)

Lamps: 1 x Citizen_CLU730_(-1210B8-273M2G1)_IDEAL_50-2204C+50-2100AN

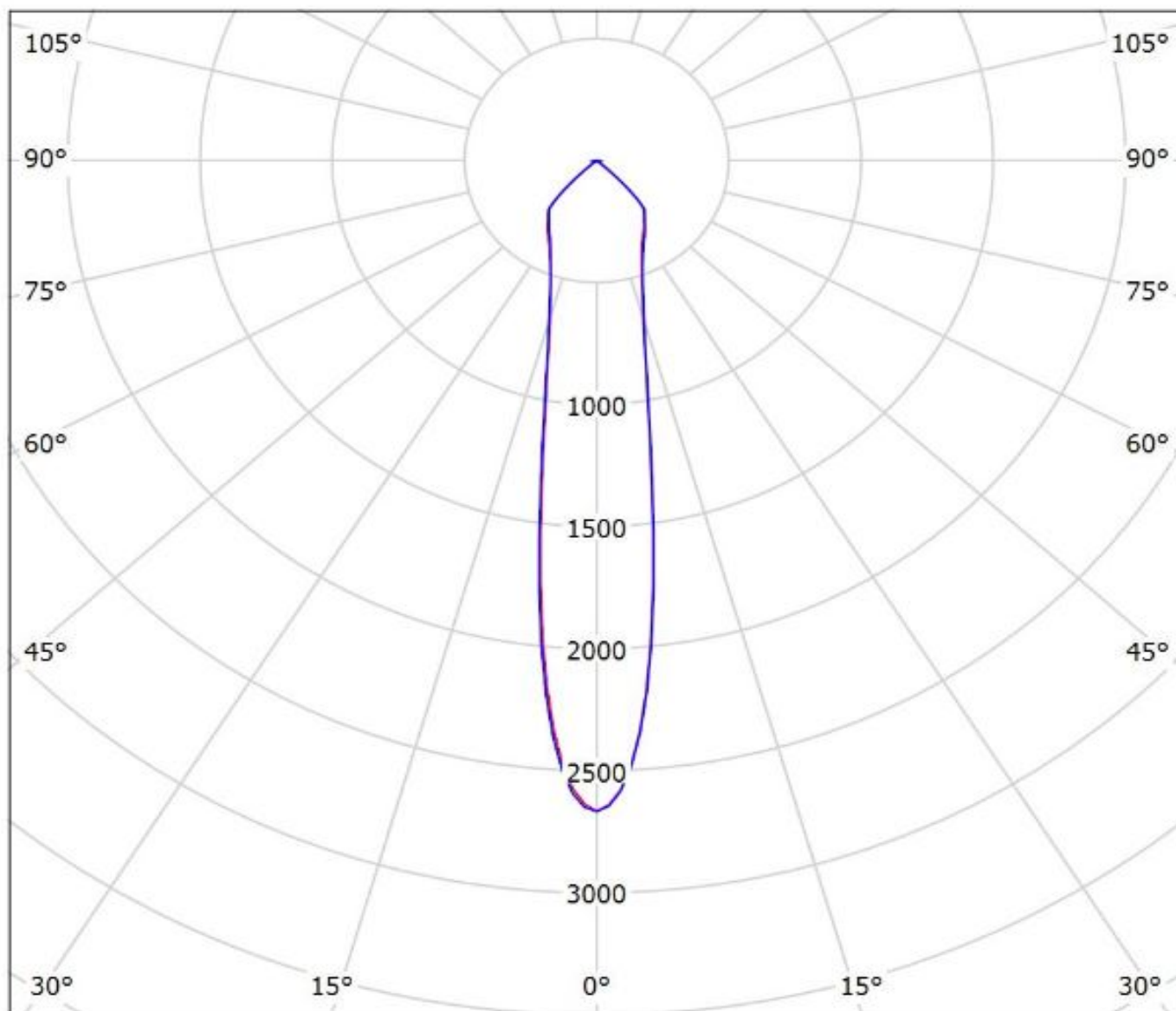

cd/klm

— C0 - C180 — C90 - C270

$\eta = 92\%$

Luminaire: LEDiL Oy F13325_ANGELINA-S_(CXA30) Eff.94%

Lamps: 1 x CREE_CXA30_(CXA3050-3C0-Y2-N0H)_1340.66lm@250mA_P=8.16471W_CCT=5000K_I=249.8mA

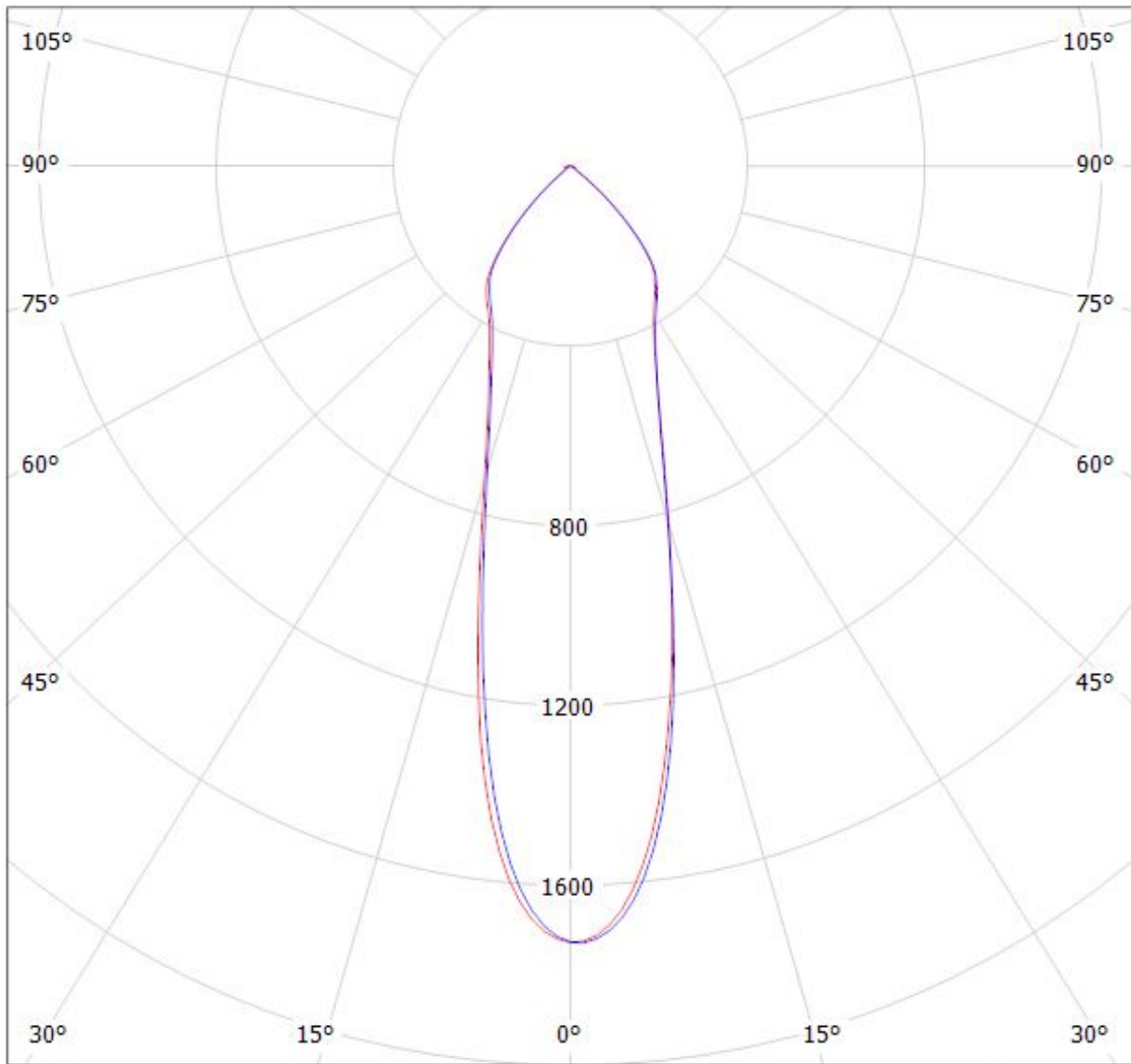

cd/klm

— C0 - C180

— C90 - C270

$\eta = 94\%$

Luminaire: LEDiL Oy F13325_ANGELINA-S_(CXA25) Eff.94%

Lamps: 1 x CREE_CXA25_(CXA2530-7C0-T2-N0H)_1151.98lm@250mA_CCT=3000K_P=8.4892W_I=249.8mA

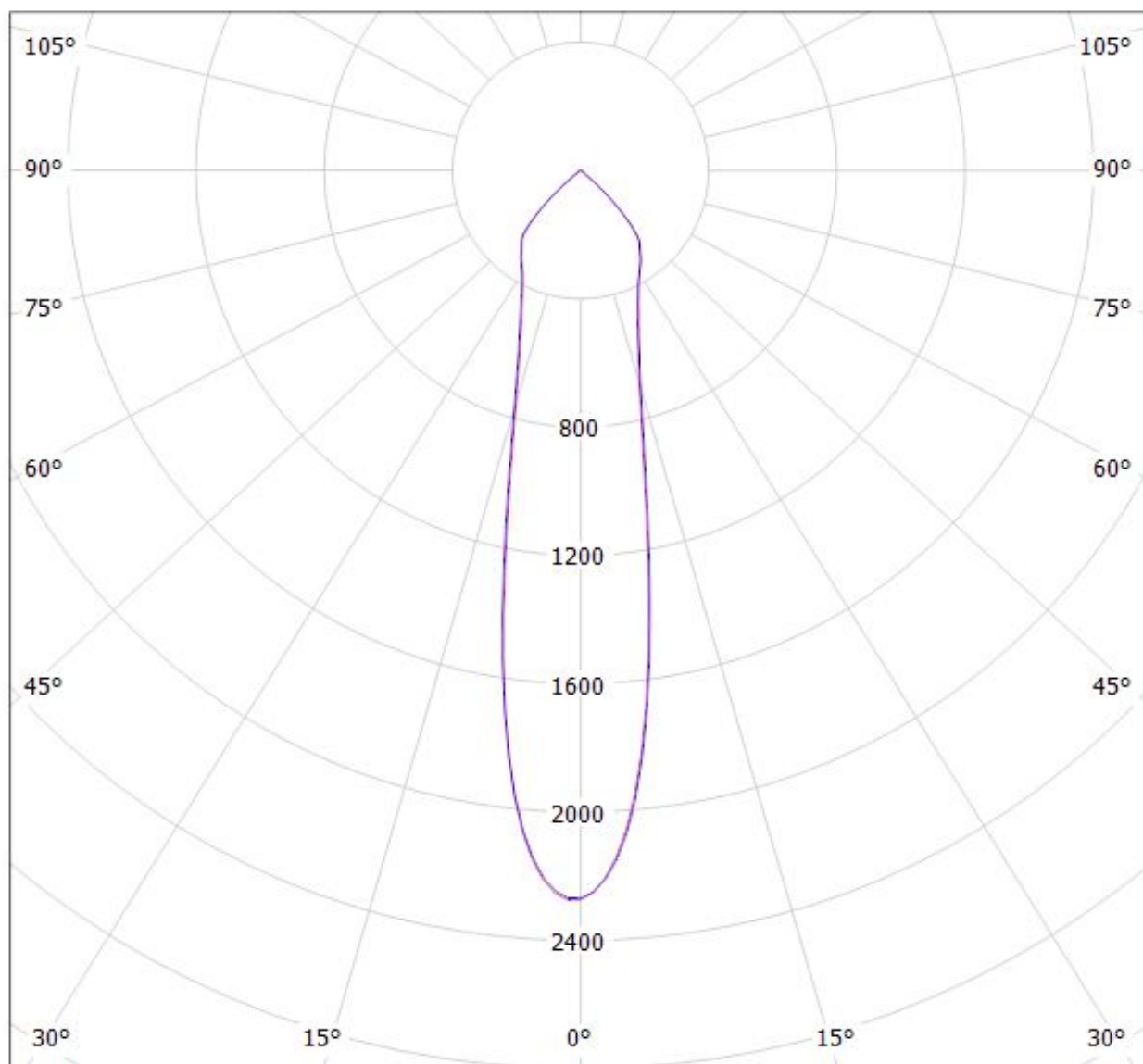

cd/klm

— C0 - C180

— C90 - C270

$\eta = 95\%$

Luminaire: LEDiL Oy F13325_ANGELINA-S_(CXA1816) Eff. 94%
Lamps: 1 x CREE_CXA1816_1050lm@250mA_P=8.65157W_I=249.9mA

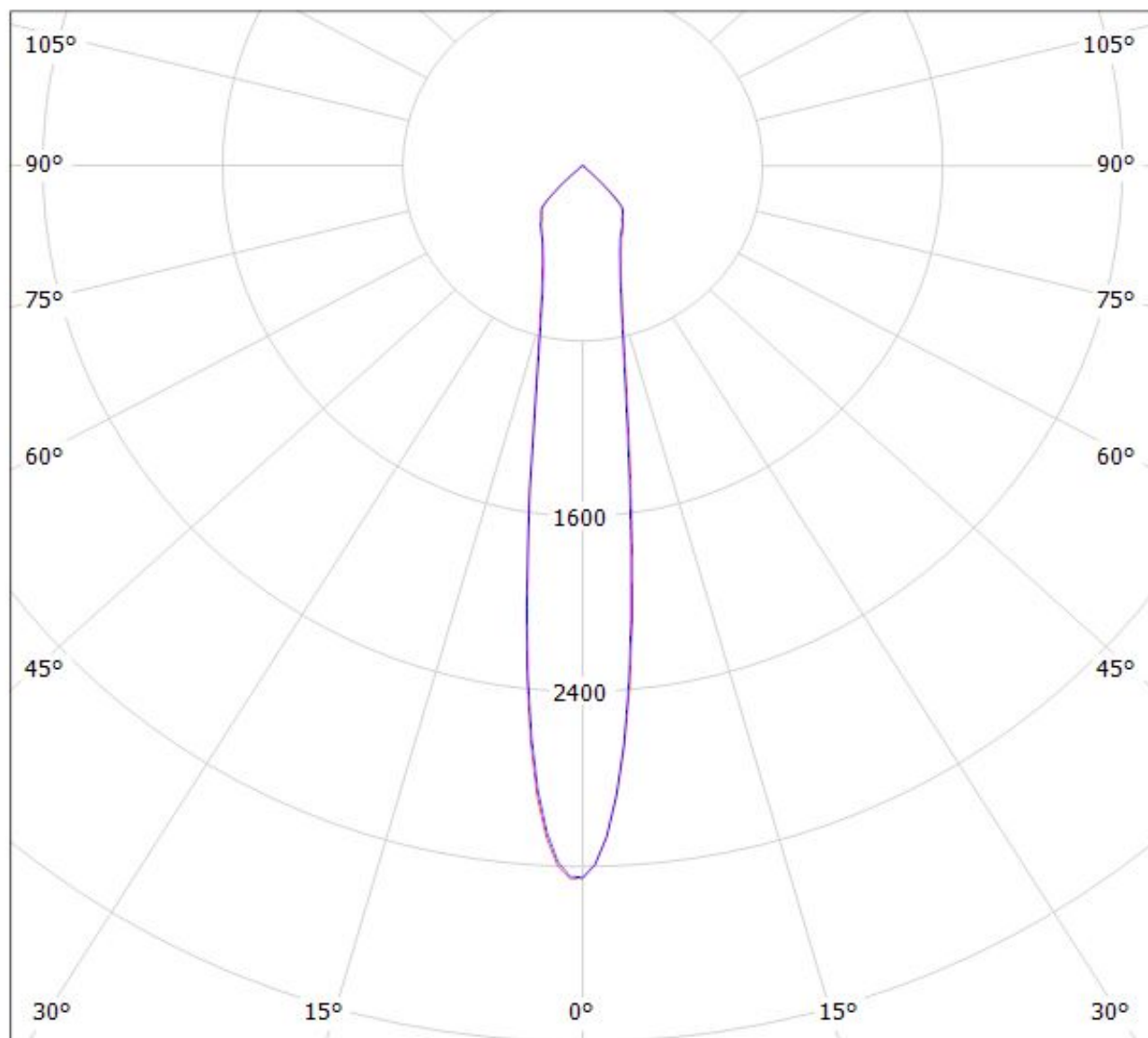

cd/klm

— C0 - C180

— C90 - C270

η = 94%

Luminaire: LEDiL Oy F13325_ANGELINA-S_(CXA3590)

Lamps: 1 x CREE_CXA3590_(CXA3590-30F-BD-R0H-0002)_2640.14lm@250mA_CCT=3000K_P=16.3941W_I=249.8mA

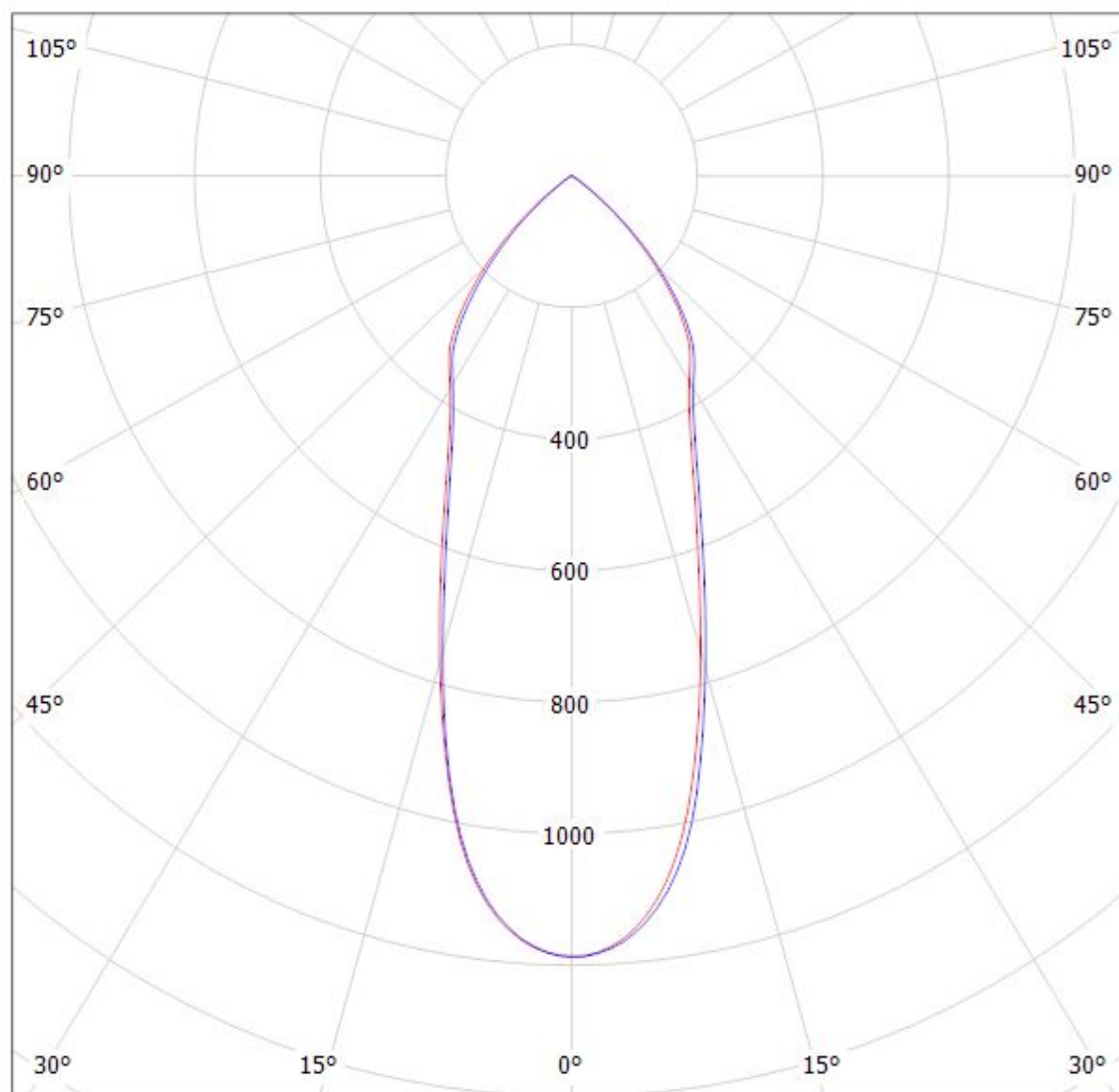

cd/klm

— C0 - C180

— C90 - C270

$\eta = 93\%$

Luminaire: LEDiL Oy F13325_ANGELINA-S_(LG_COB-10W) Eff.93.9%
Lamps: 1 x LG_COB-10W_1024lm@250mA_CCT=5090K_P=9W_I=250mA

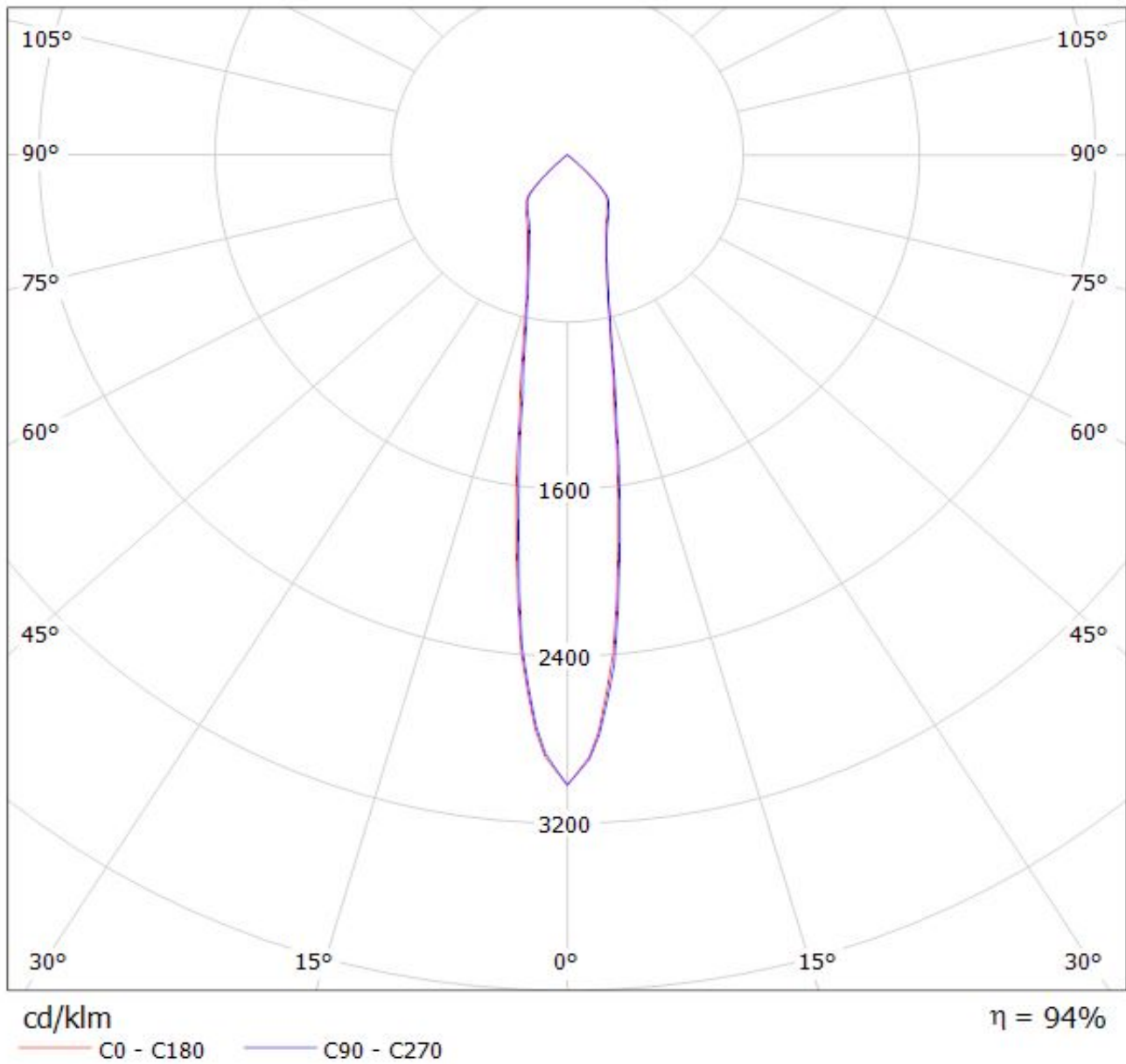

Luminaire: LEDiL Oy C13325_ANGELINA-S_(Luxeon_K16) Eff.94.2%
Lamps: 1 x LUXEON_K16 (1204.33lm@250mA)

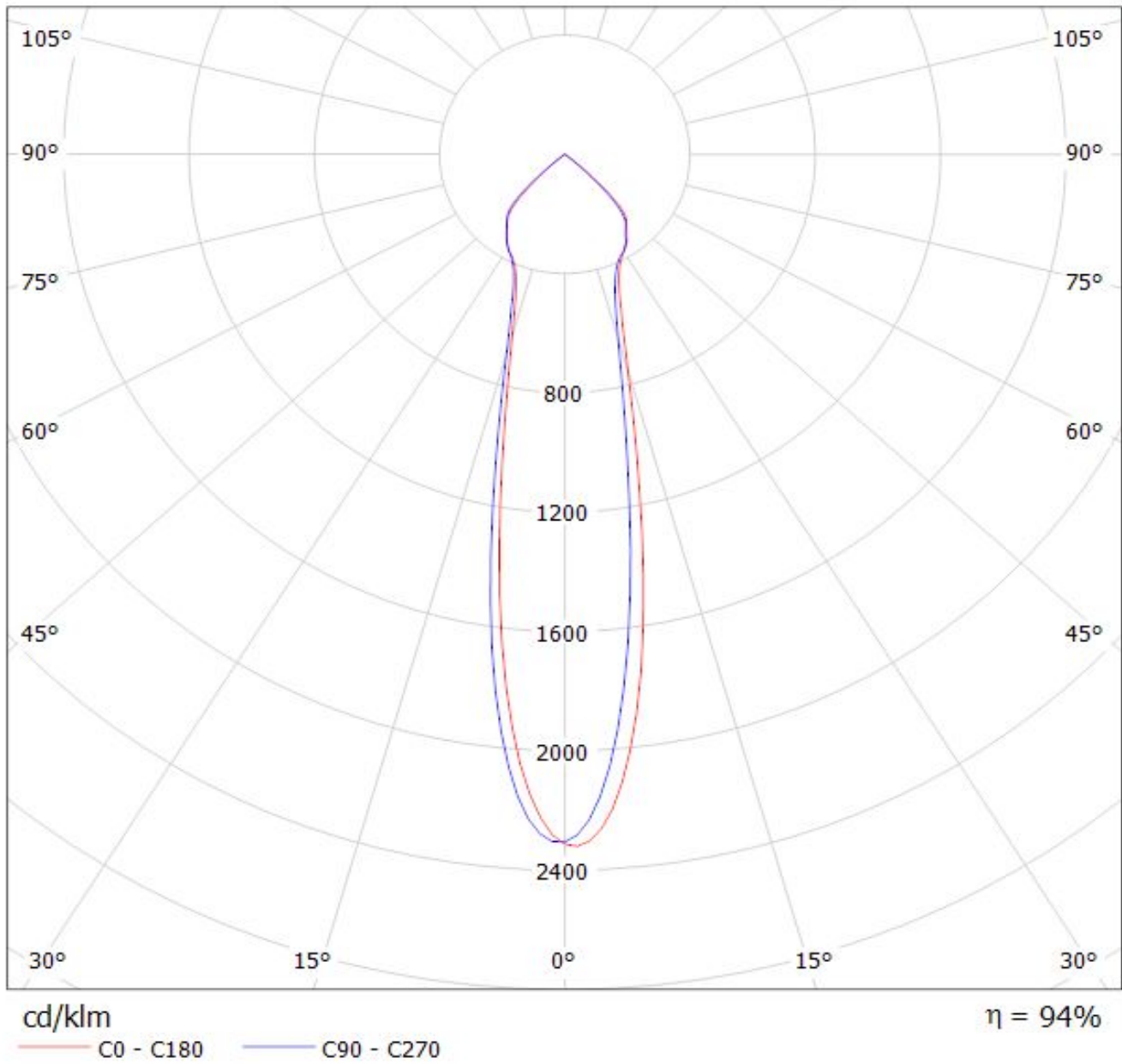

LEDiL Oy C13325_ANGELINA-S_(LUXEON_K12) Eff.94.3% / LDC (Polar)

Luminaire: LEDiL Oy C13325_ANGELINA-S_(LUXEON_K12) Eff.94.3%

Lamps: 1 x LUXEON_K12 (929.543lm@250mA)

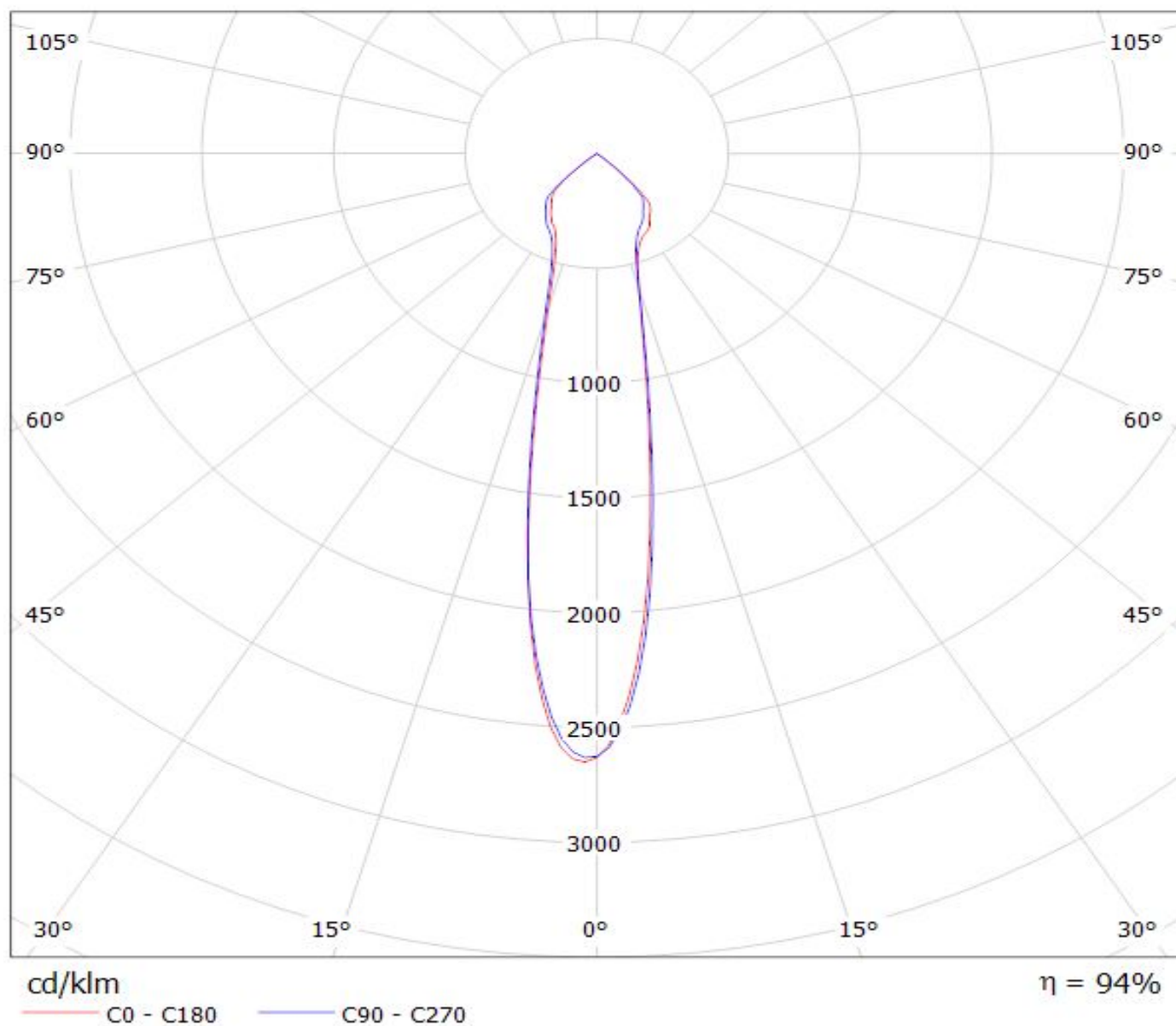

Luminaire: LEDiL Oy F13325_ANGELINA-S_(LUXEON CoB 1205) Eff: 94 %
Lamps: 1 x LUXEON CoB 1205 (LHC1-3080-1205) 1082lm@250mA CCT=3000K P=8.3W I=250mA

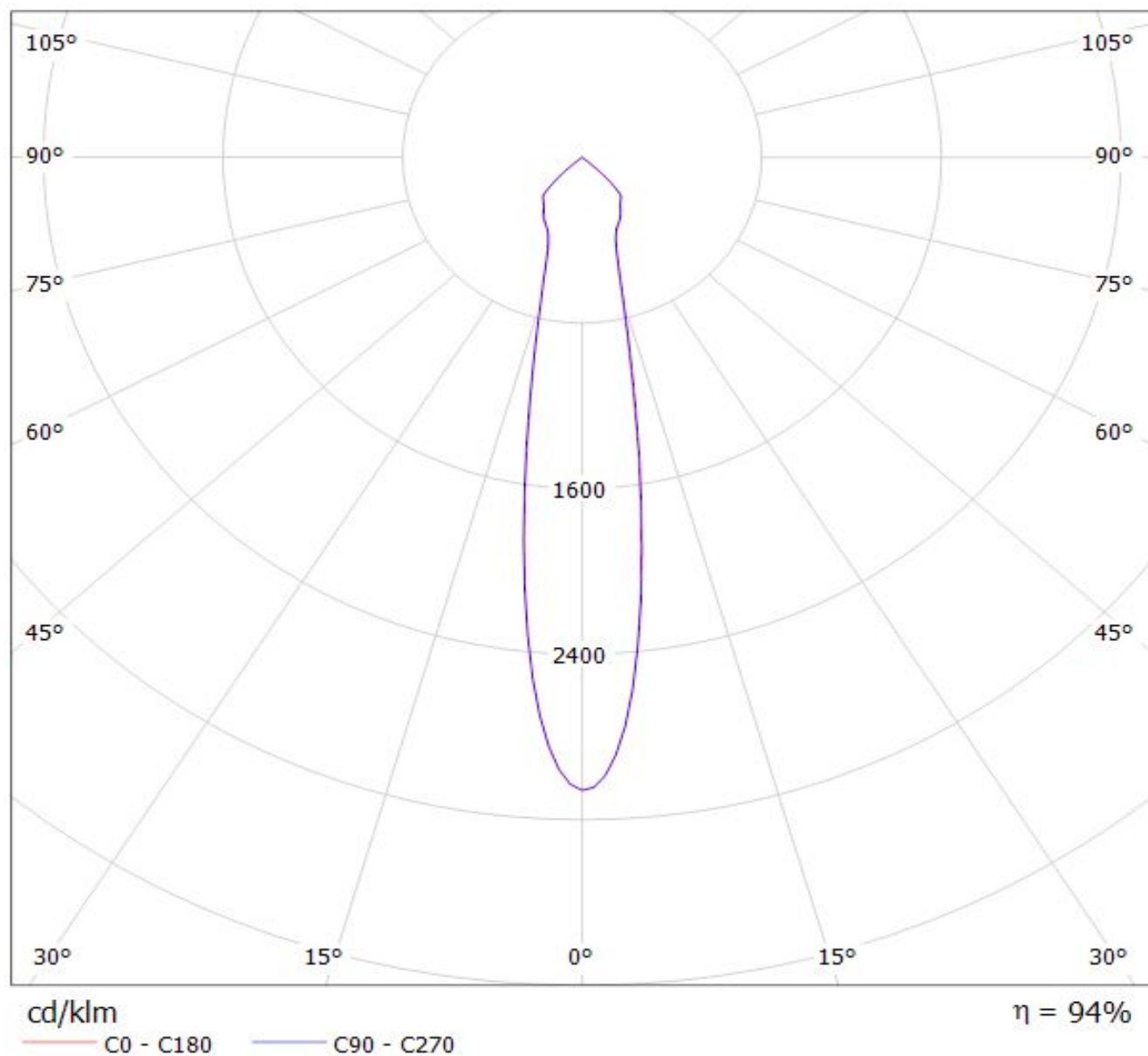

Luminaire: LEDiL Oy F13325_ANGELINA-S_(Luxeon-Cob-1208) Eff. 93 %
Lamps: 1 x Luxeon CoB 1208 (LHC1-3080-1208) 1029lm@250mA CCT=3000K P=8.2W I=250mA

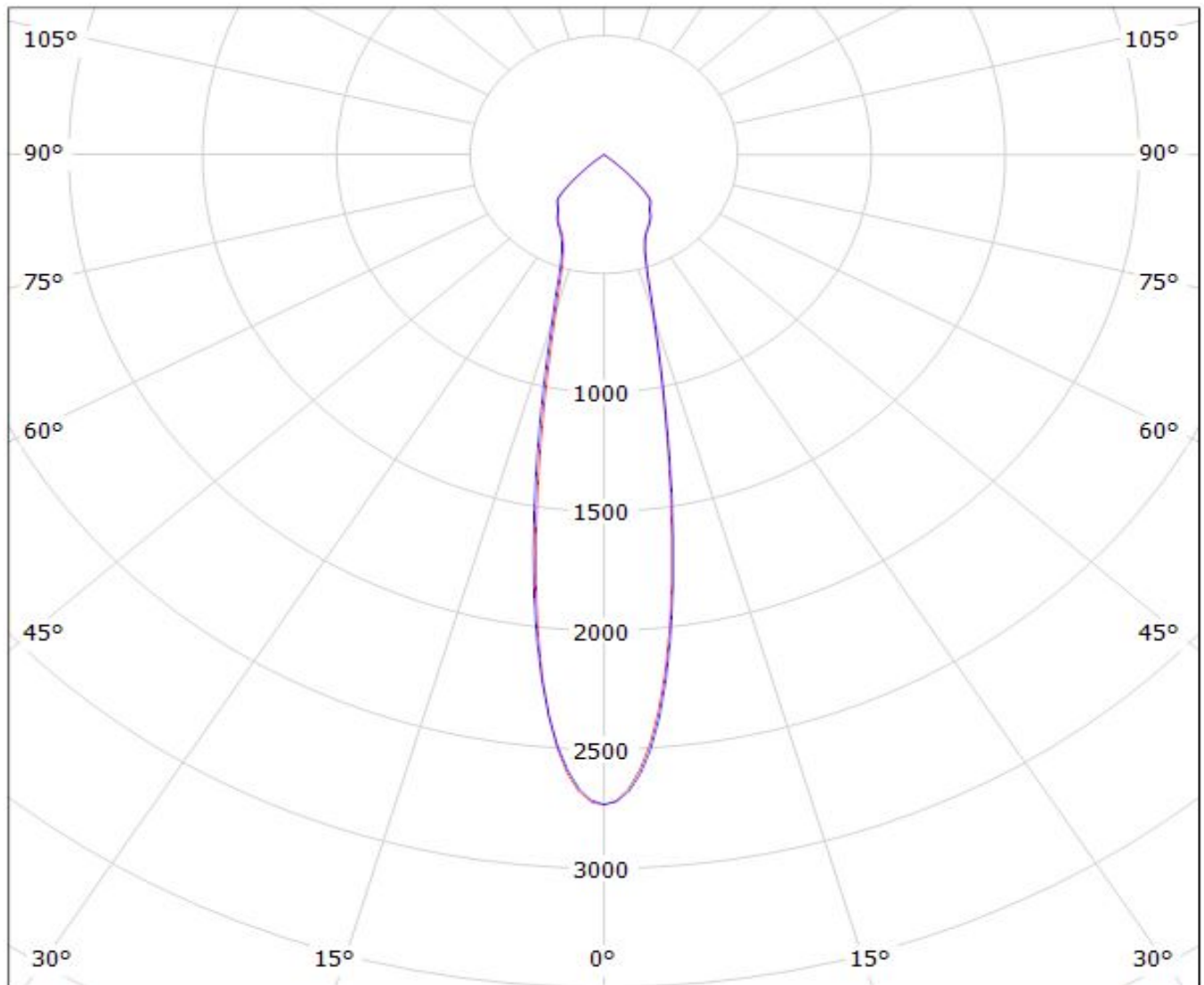

cd/klm

— C0 - C180 — C90 - C270

$\eta = 93\%$

Luminaire: LEDiL Oy F13325_ANGELINA-S_(LUXEON_COB_1205) Eff.93.8%

Lamps: 1 x LUXEON_COB_1205_(LHC1-3080-1205)_1084.49lm@250mA_CCT=3000K_P=8.31784W_I=249.8mA

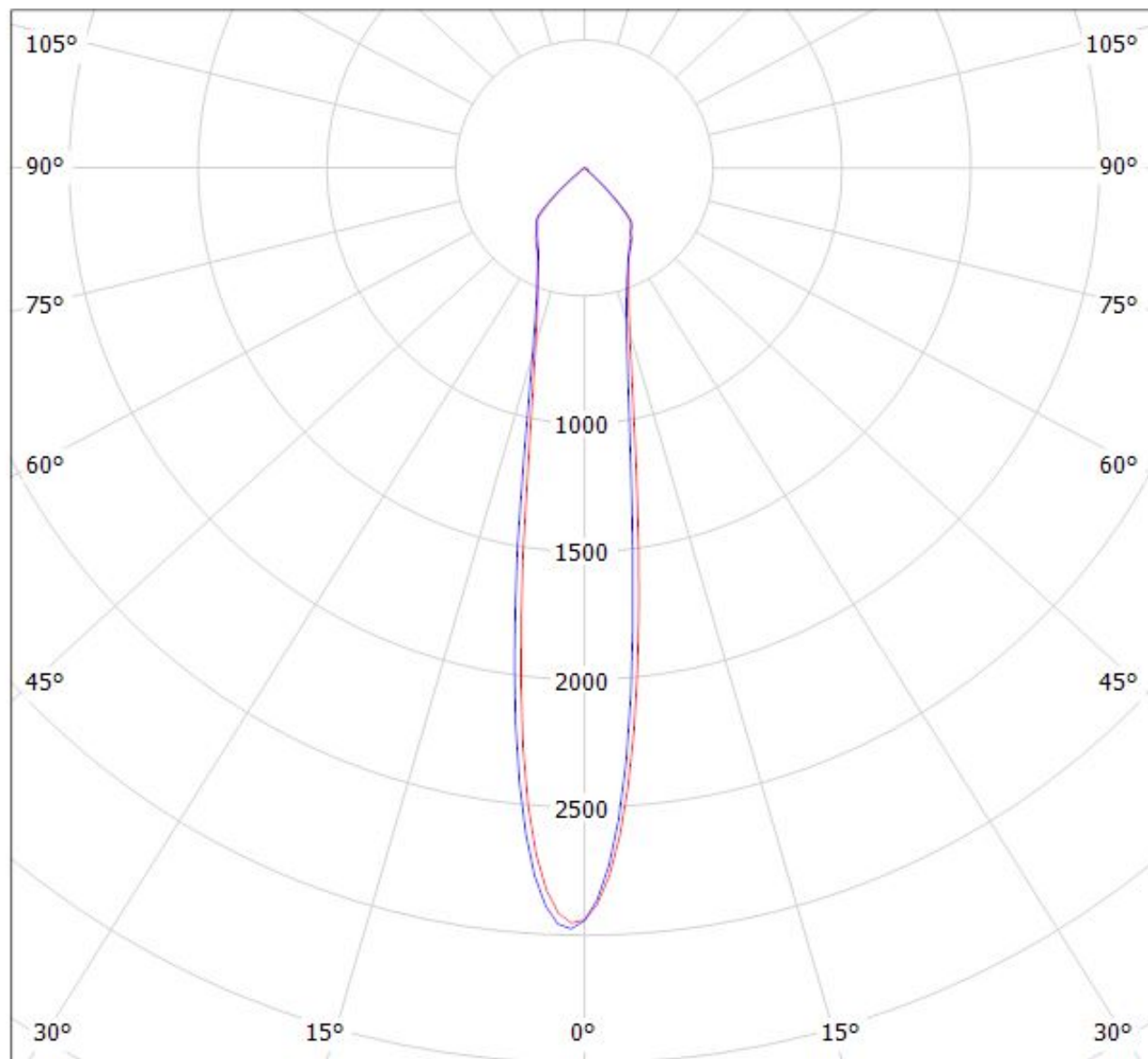

cd/klm

— C0 - C180

— C90 - C270

$\eta = 94\%$

Luminaire: LEDiL Oy F13325_ANGELINA-S_(LUXEON_COB_1208) Eff.93.8%
Lamps: 1 x LUXEON_COB_1208_(LHC1-3080-1208)_1015.13lm@250mA_CCT=3000K_P=8.15972W_I=249.8mA

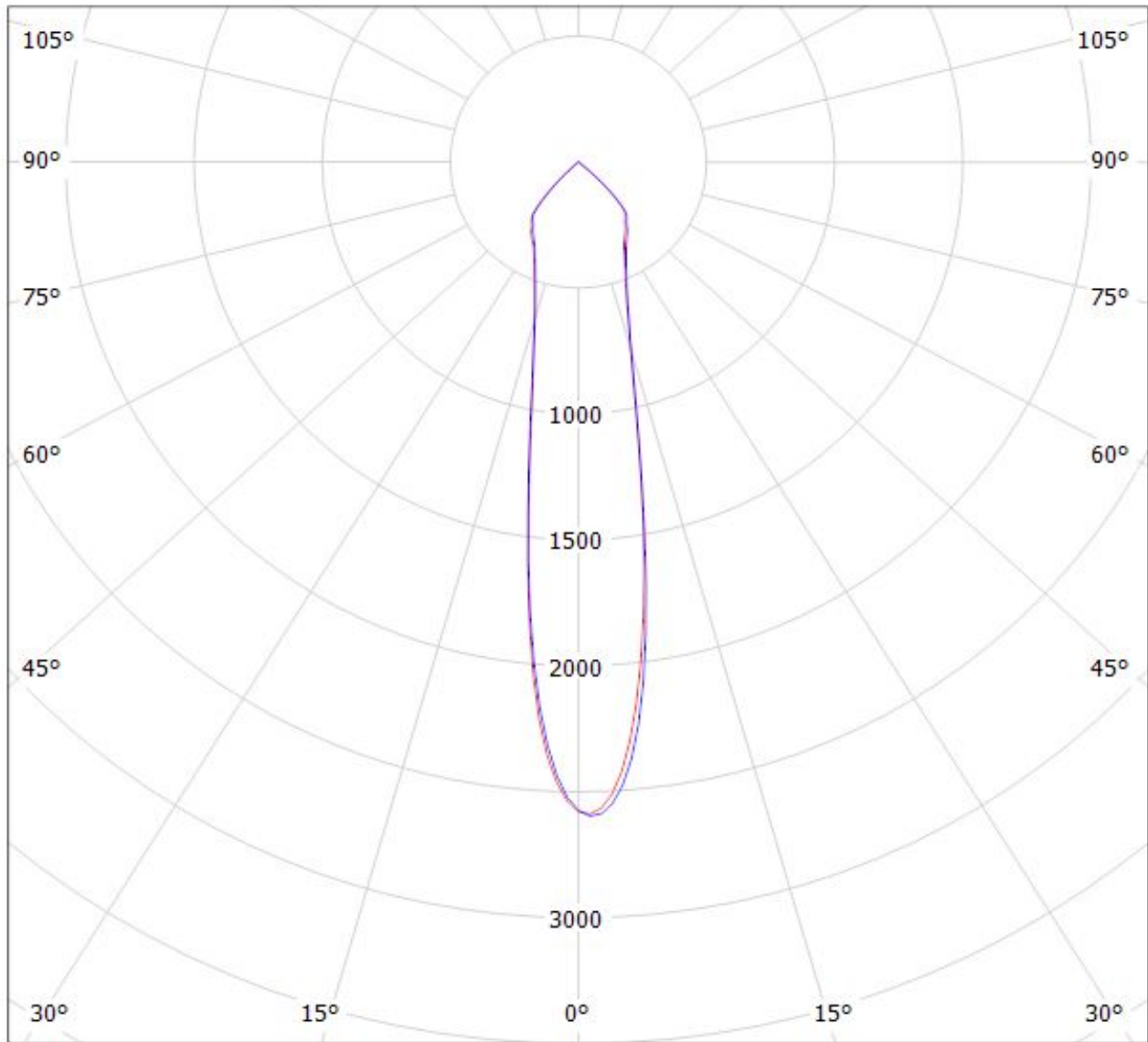

cd/klm

$\eta = 94\%$

— C0 - C180 — C90 - C270

Luminaire: Ledil F13325_ANGELINA-S_(CoB1211+IDEAL)
Lamps: 1 x Luxeon_CoB1211_(L2C2-4080)_50-2204CT+50-2100AN_1376.18lm@250mA_P=7.9988W_I=0.25A

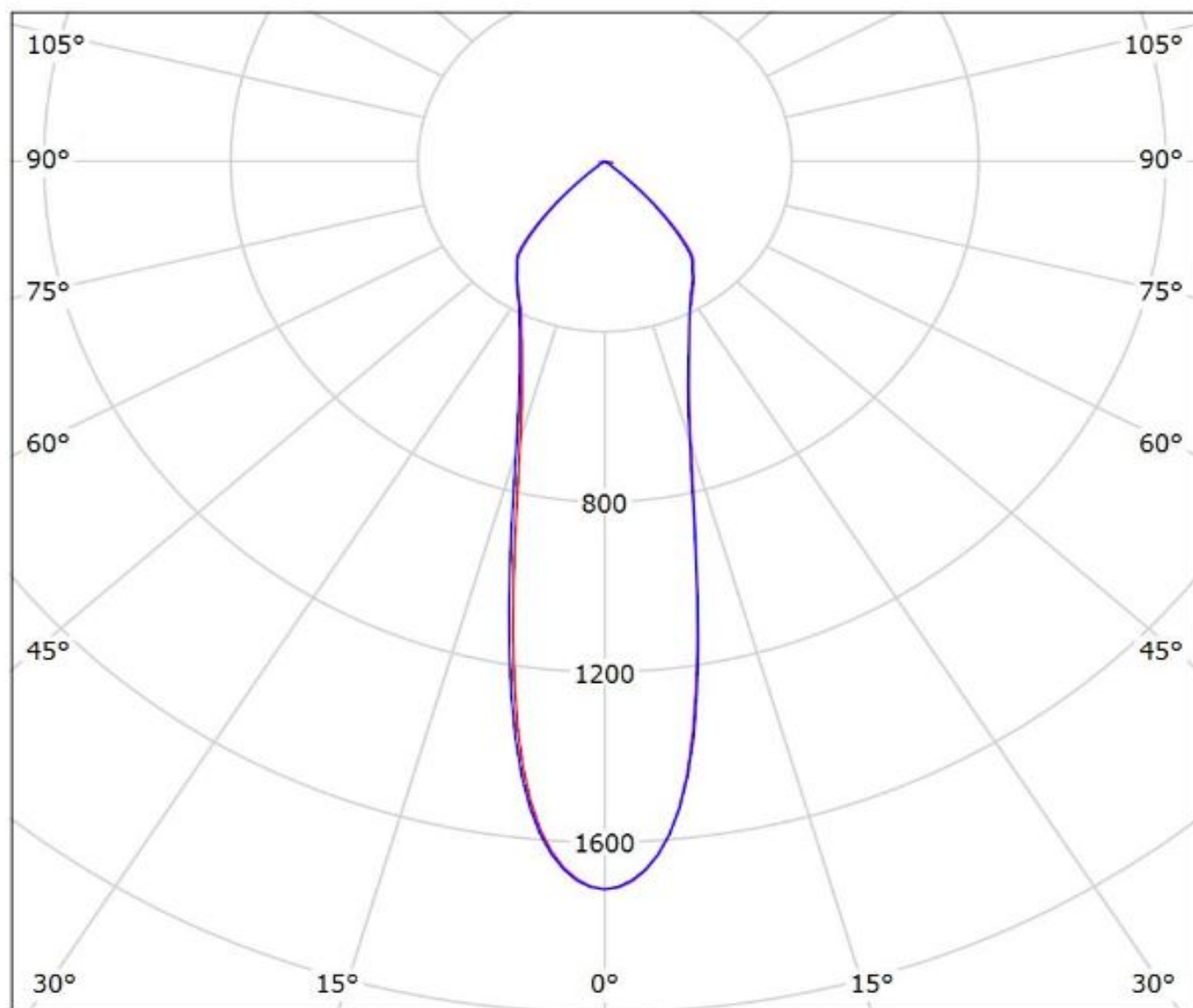

cd/klm

— C0 - C180 — C90 - C270

$\eta = 91\%$

Luminaire: LEDiL Oy F13325_ANGELINA-S_(CXM-14)

Lamps: 1 x LUMINUS_CXM-14_1114.36lm@250mA_P=8.36106W_I=249.8mA

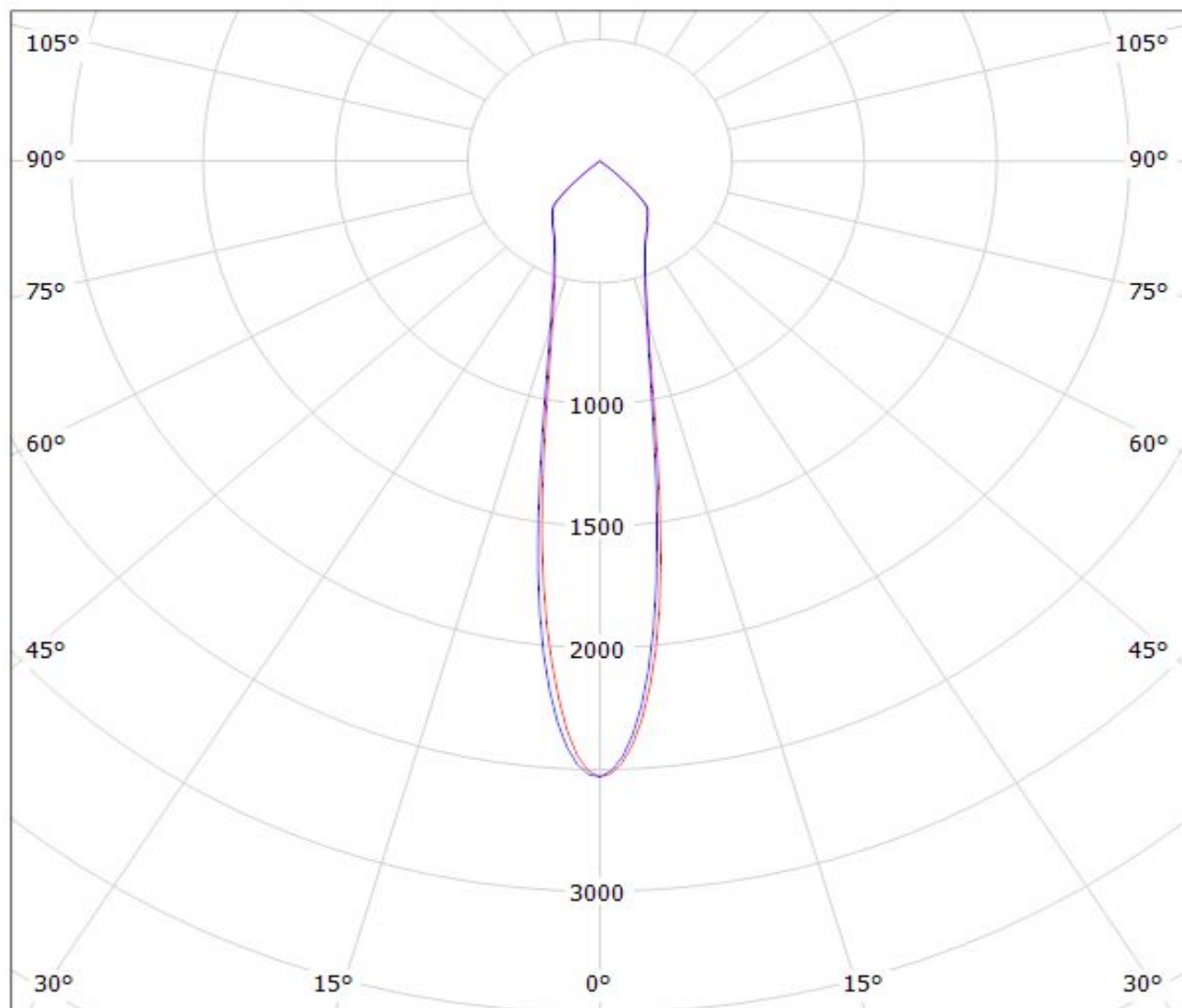

cd/klm

— C0 - C180

— C90 - C270

$\eta = 94\%$

Luminaire: LEDiL Oy F13325_ANGELINA-S_(NSBxL121A) Eff.91.2%

Lamps: 1 x NICHIA_NSBxL121A_(NSBLL121AE)_805.561lm@250mA_CCT=3000K_P=7.3681W_I=249.8mA

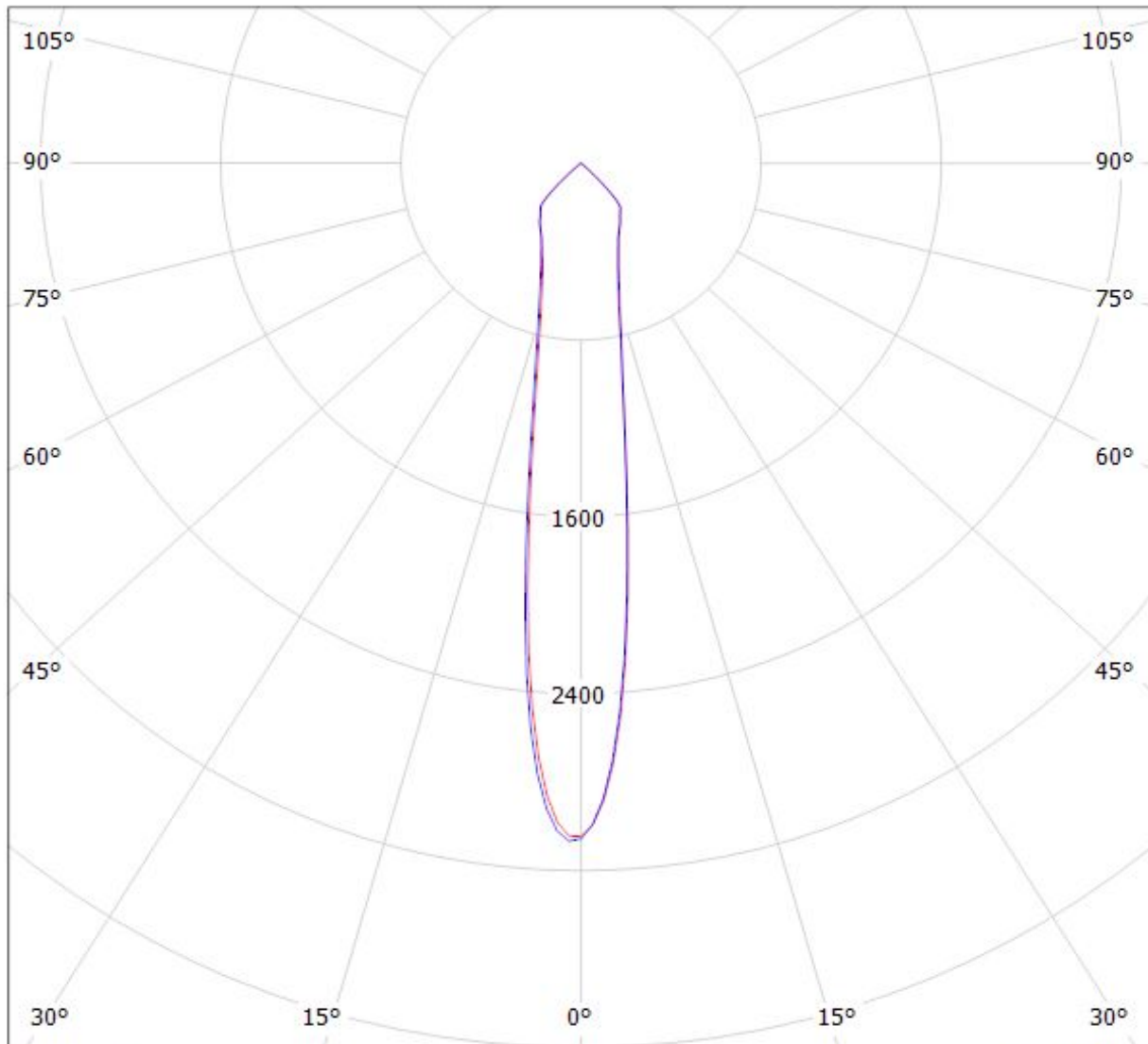

cd/klm

— C0 - C180

— C90 - C270

$\eta = 91\%$

Luminaire: LEDiL Oy F13325_ANGELINA-S_(NSCxJ216A) Eff.94.0%

Lamps: 1 x NICHIA_NSCxJ216A_(NSCLJ216AE)_971.7lm@250mA_CCT=3000K_P=7.96937W_I=249.8mA

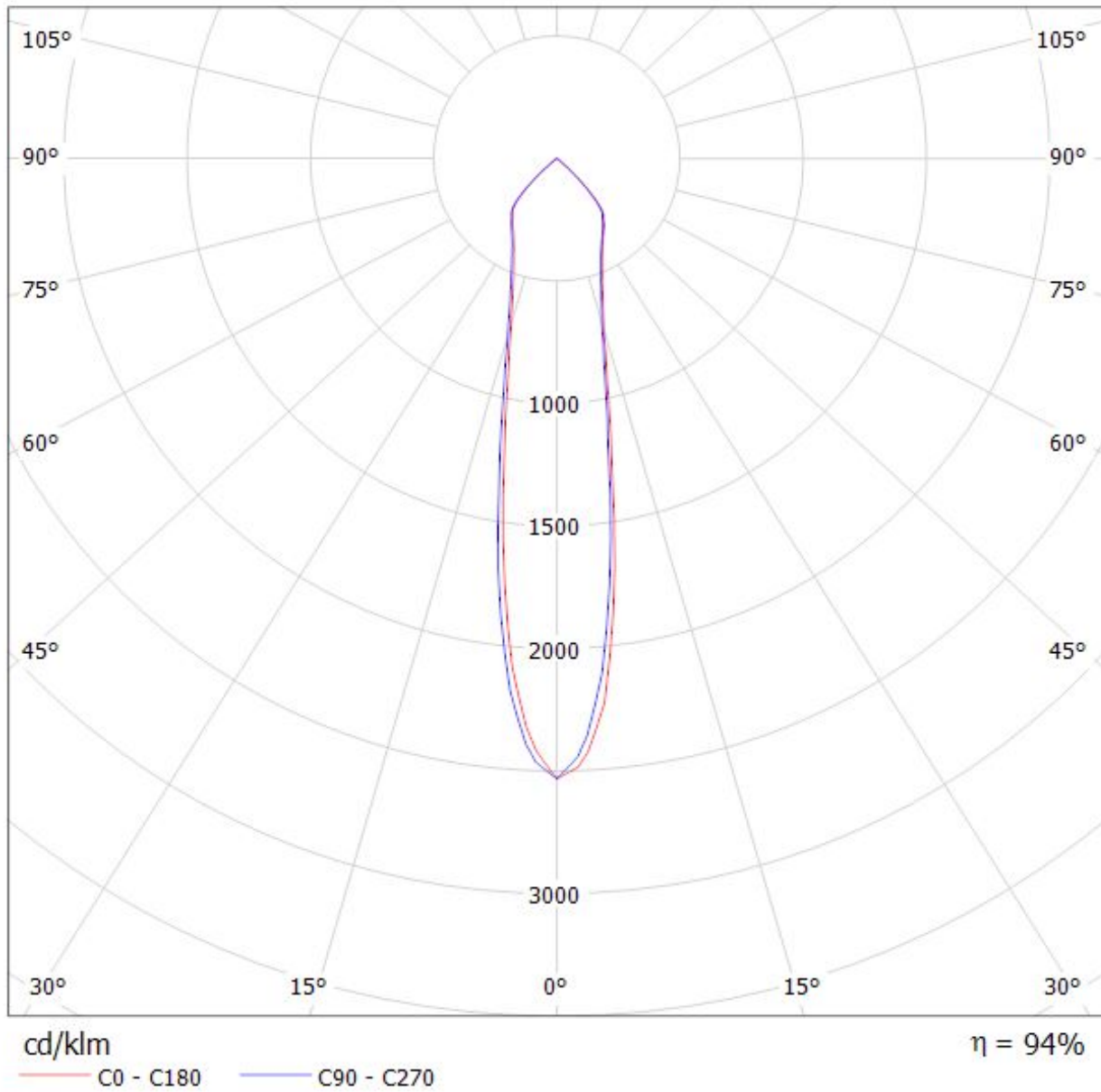

Luminaire: LEDiL Oy F13325_ANGELINA-S_(NSBxL121A)

Lamps: 1 x Nichia_NSBxL121A_914.478lm@250mA_P=7.56872W_I=249.9mA

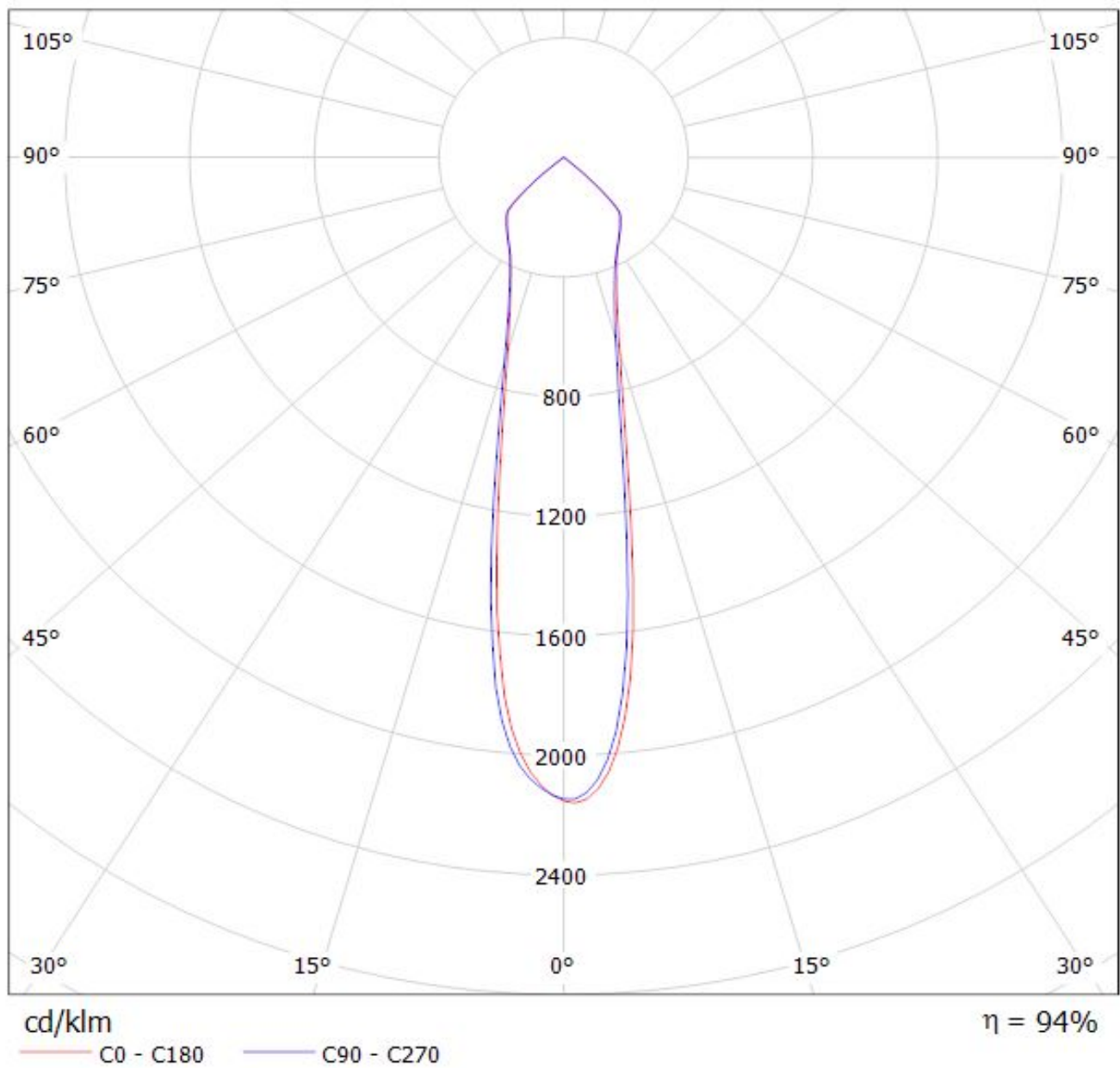

Luminaire: Ledil F13325_ANGELINA-S_(NVCLL024Z+TE)

Lamps: 1 x Nichia_NVCLL024Z_+2213382-2_+2213194-1_971.485lm@250mA_CCT=3000K_P=8W_I=0.25A

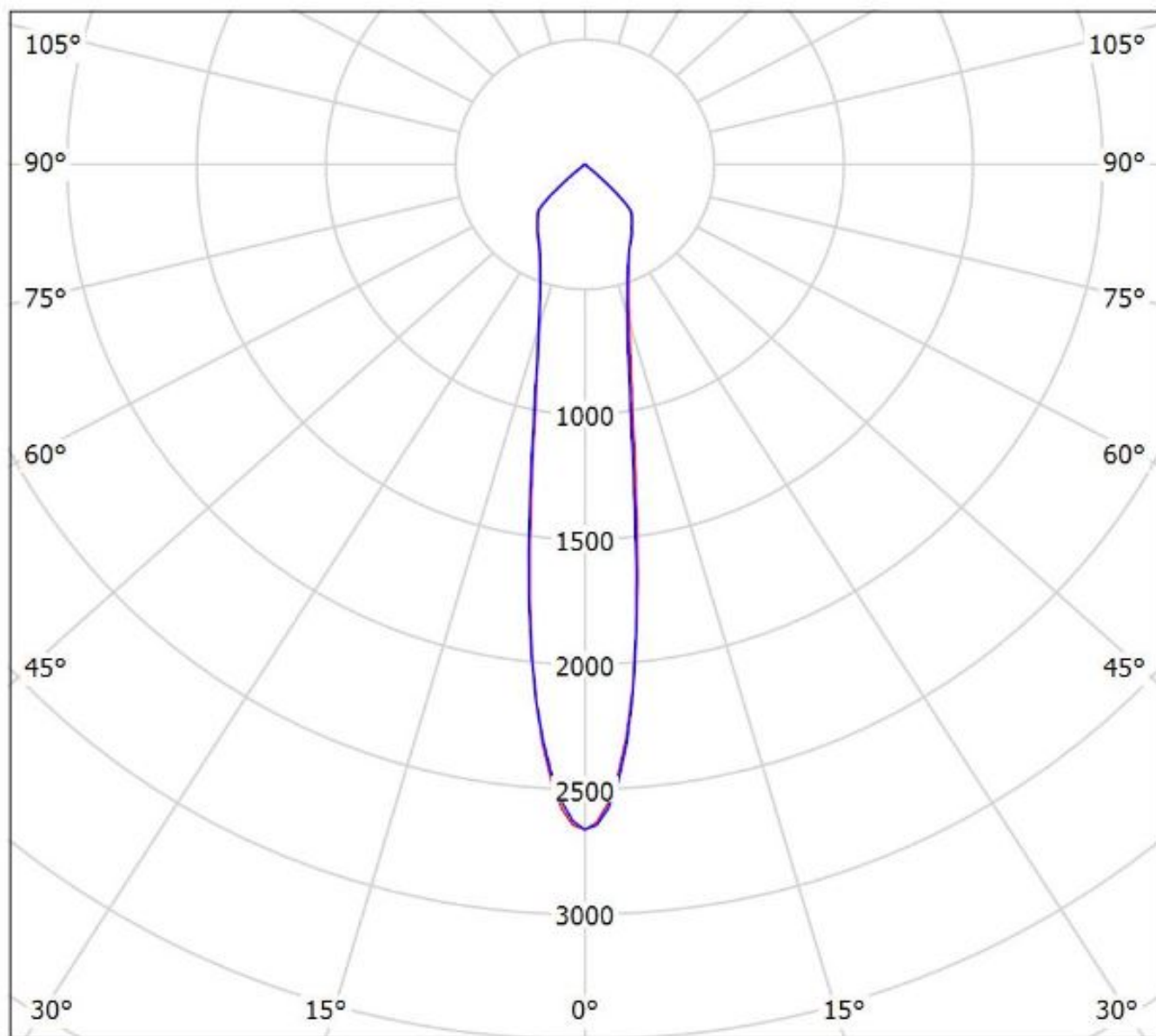

cd/klm

— C0 - C180 — C90 - C270

$\eta = 92\%$

Luminaire: LEDiL Oy F13325_ANGELINA-S_(PrevaLED_LES9) Eff. 94%
Lamps: 1 x PrevaLED_LES9_(PL-CORE-1100-830-Z3)_507.9lm@100mA_P=4.5039W_I=100.1mA

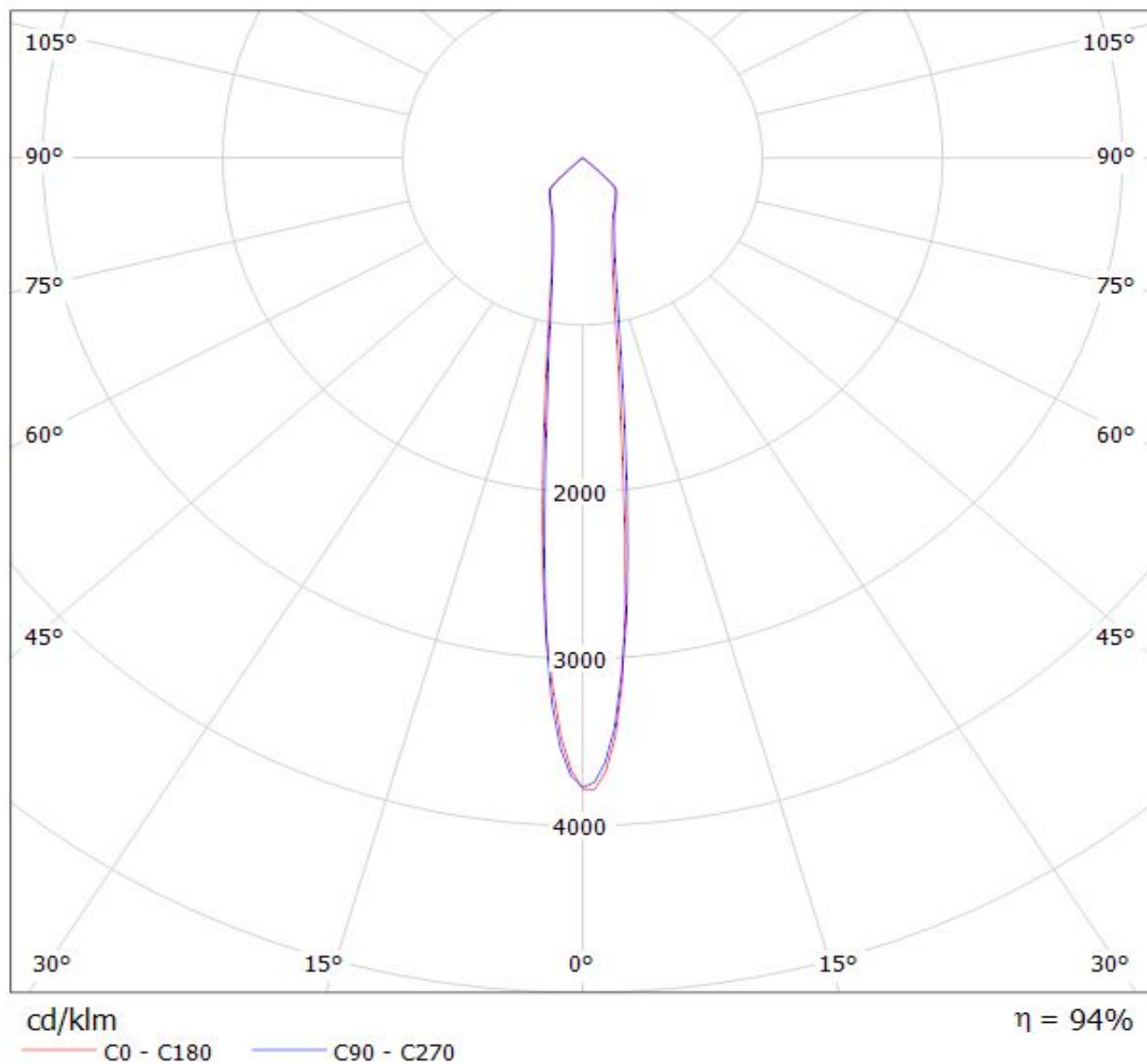

Luminaire: LEDiL Oy F13325_ANGELINA-S_(PrevaLED_LES19) Eff.94%

Lamps: 1 x OSRAM PrevaLED_LES9_(PL-CORE-1100-830-Z3)_1333.47lm@250mA_P=10.4584W_I=249.8mA

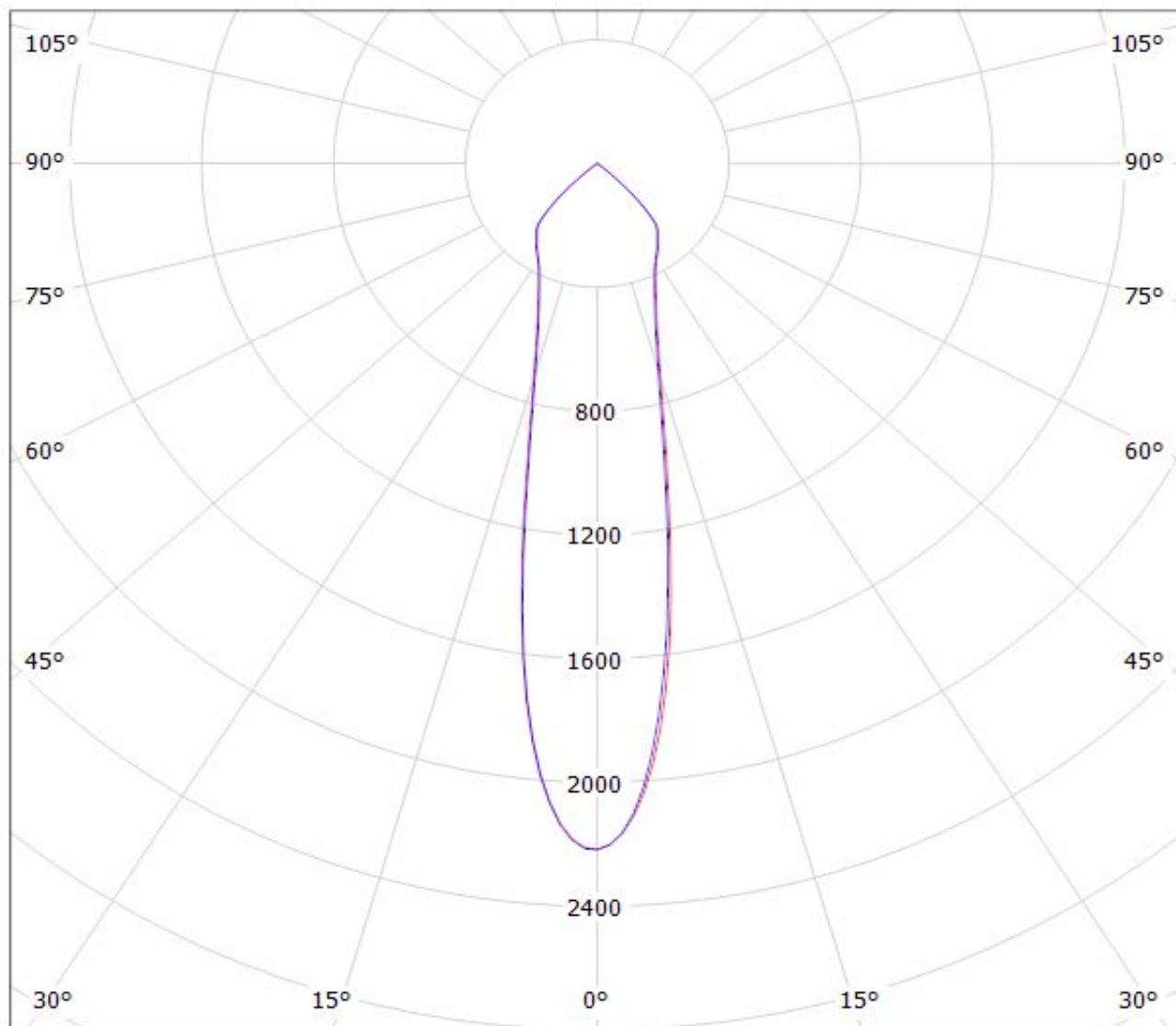

cd/klm

$\eta = 94\%$

— C0 - C180

— C90 - C270

Luminaire: LEDiL Oy F13325_ANGELINA-S_(PrevaLED_LES23) Eff. 94%
Lamps: 1 x OSRAM PrevaLED_LES23_(PL-CORE-5000-930-Z3)_1102.2lm@250mA_P=9.93654W_I=249.8mA

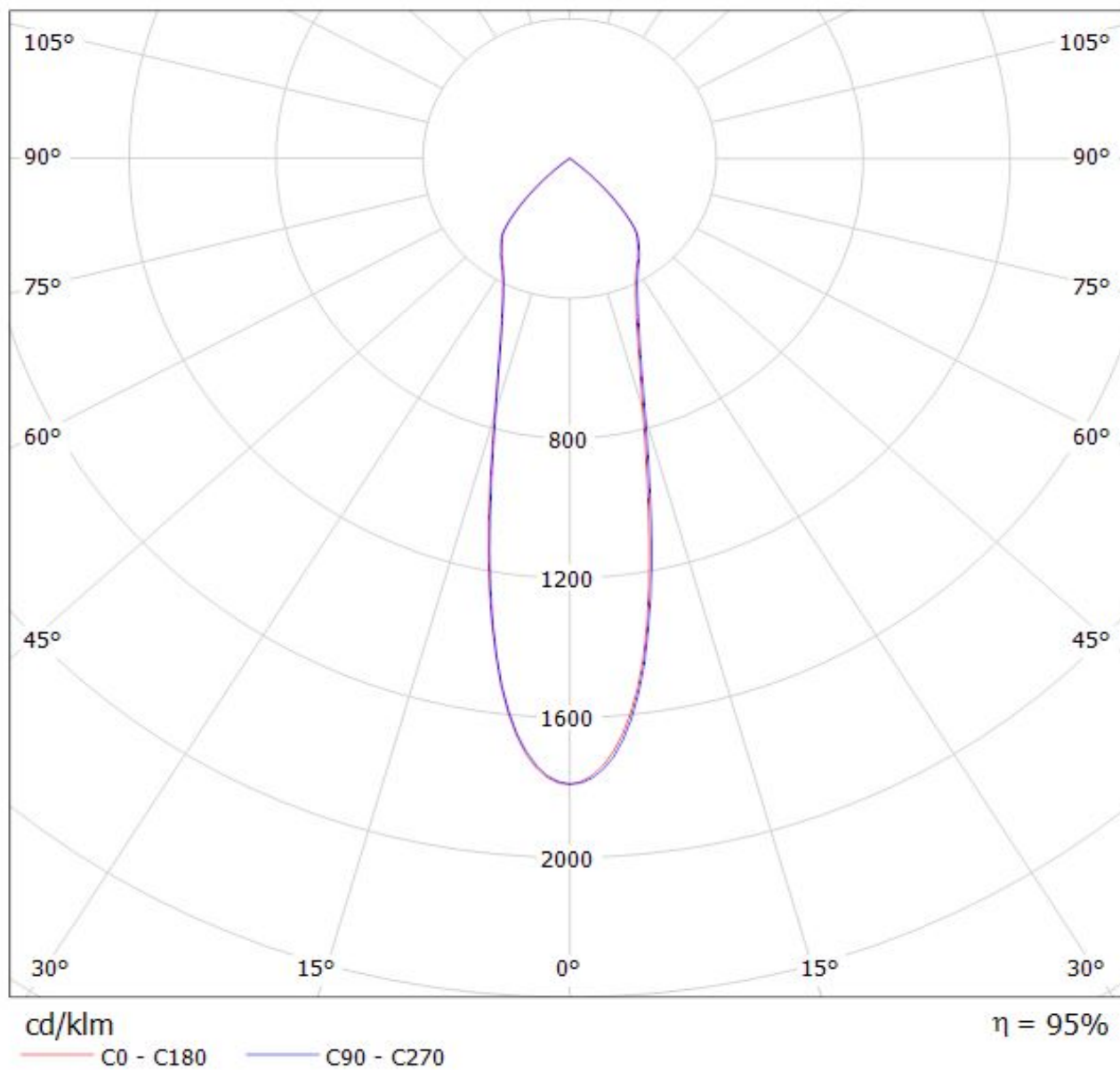

Luminaire: LEDil OY F13325_ANGELINA-S_(Soleriq_S13) Efficiency=94%

Lamps: 1 x Osram Soleriq S13 (GW KAGHB1.EM) 855lm @ 250mA CCT=3100K P=7.5W I=250mA

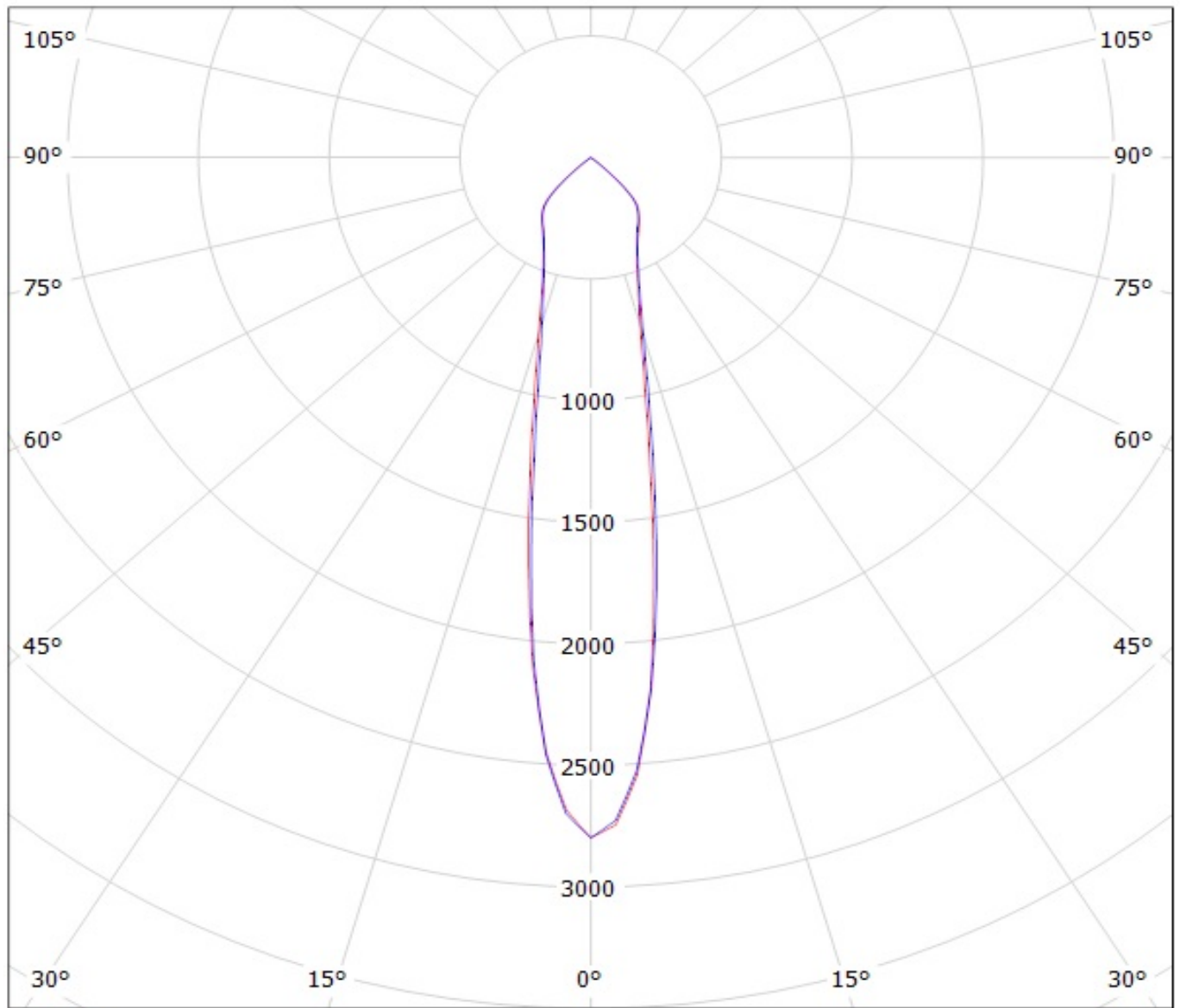

cd/klm

— C0 - C180

— C90 - C270

Luminaire: LEDiL Oy F13325_ANGELINA-S_(SOLERIQ_S19 & TE_2213407-2)

Lamps: 1 x OSRAM_SOLERIQ_S19_(GW_KAHJB1.EM)_1385.15lm@250mA_CCT=3000K_P=10.5613W_I=249.8mA

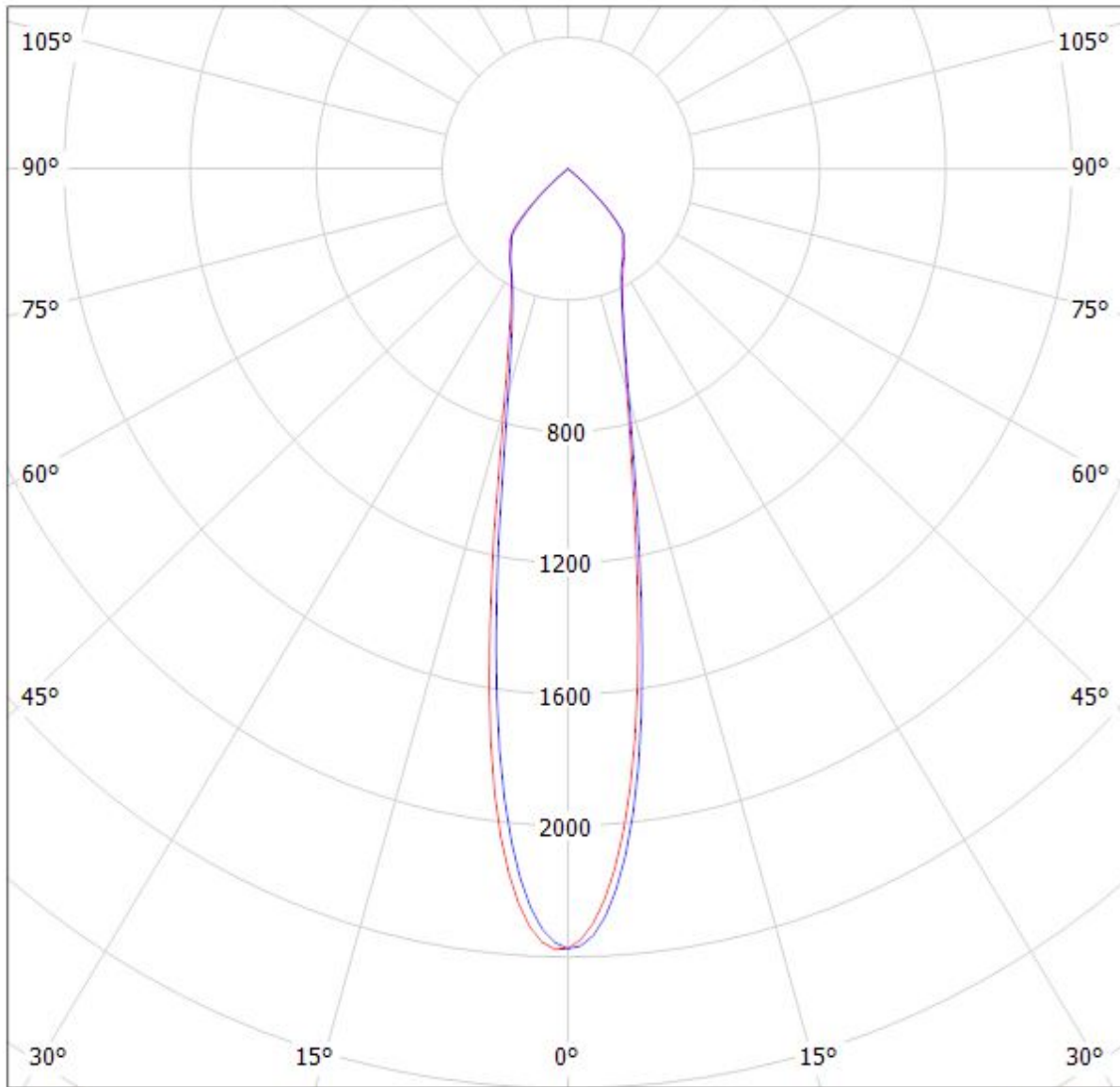

cd/klm

— C0 - C180

— C90 - C270

$\eta = 94\%$

Luminaire: LEDiL Oy F13325_ANGELINA-S_(LEP-800-827-C-AC)

Lamps: 1 x OSRAM PrevaLED Core AC (LEP-800-827-C-AC) 910lm@60mA U:230V P:14W

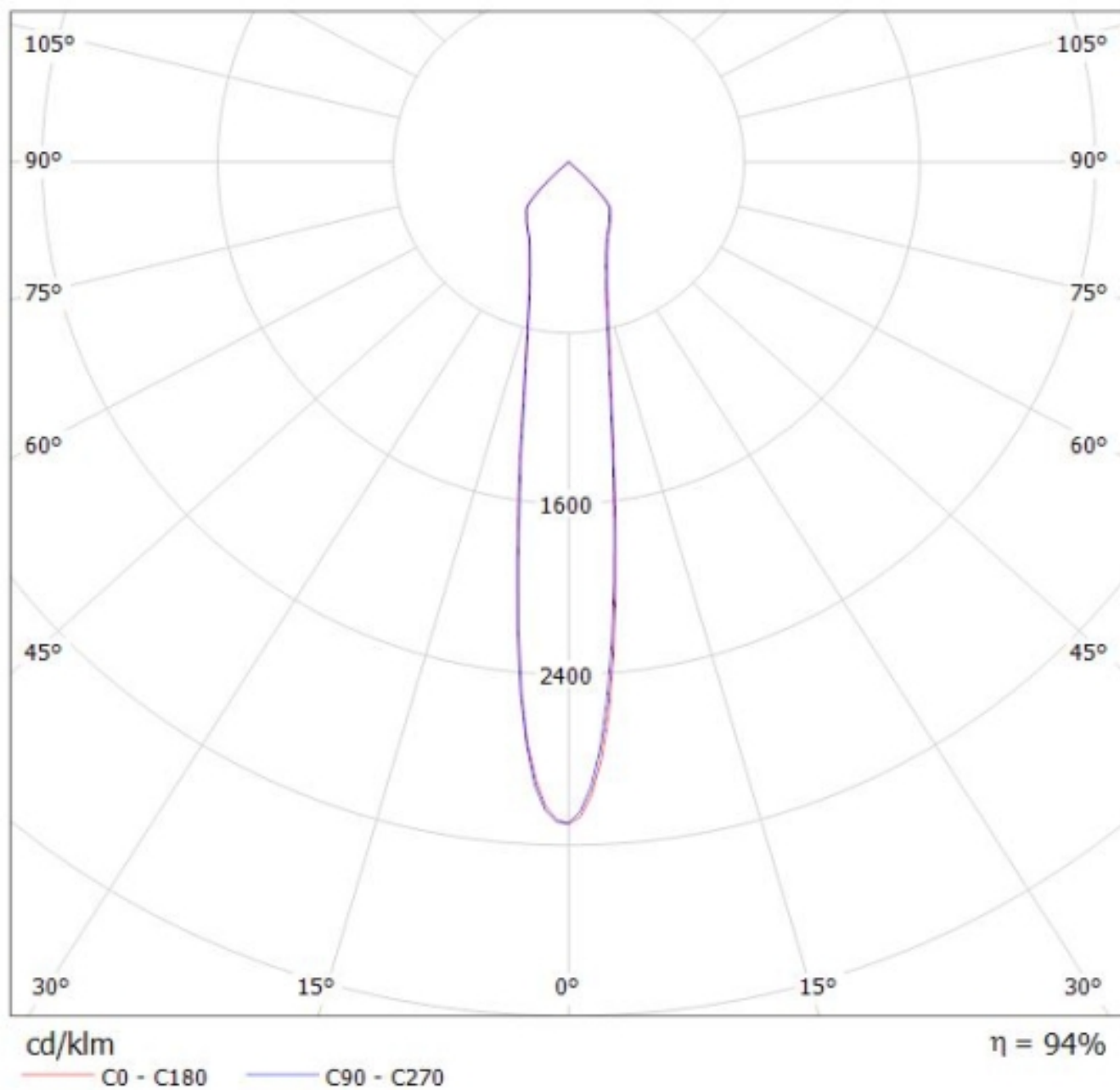

Luminaire: LEDiL Oy F13325_ANGELINA-S_(LEP-2000-827-C-AC)
Lamps: 1 x OSRAM PrevaLED Core AC (LEP-2000-827-C-AC)

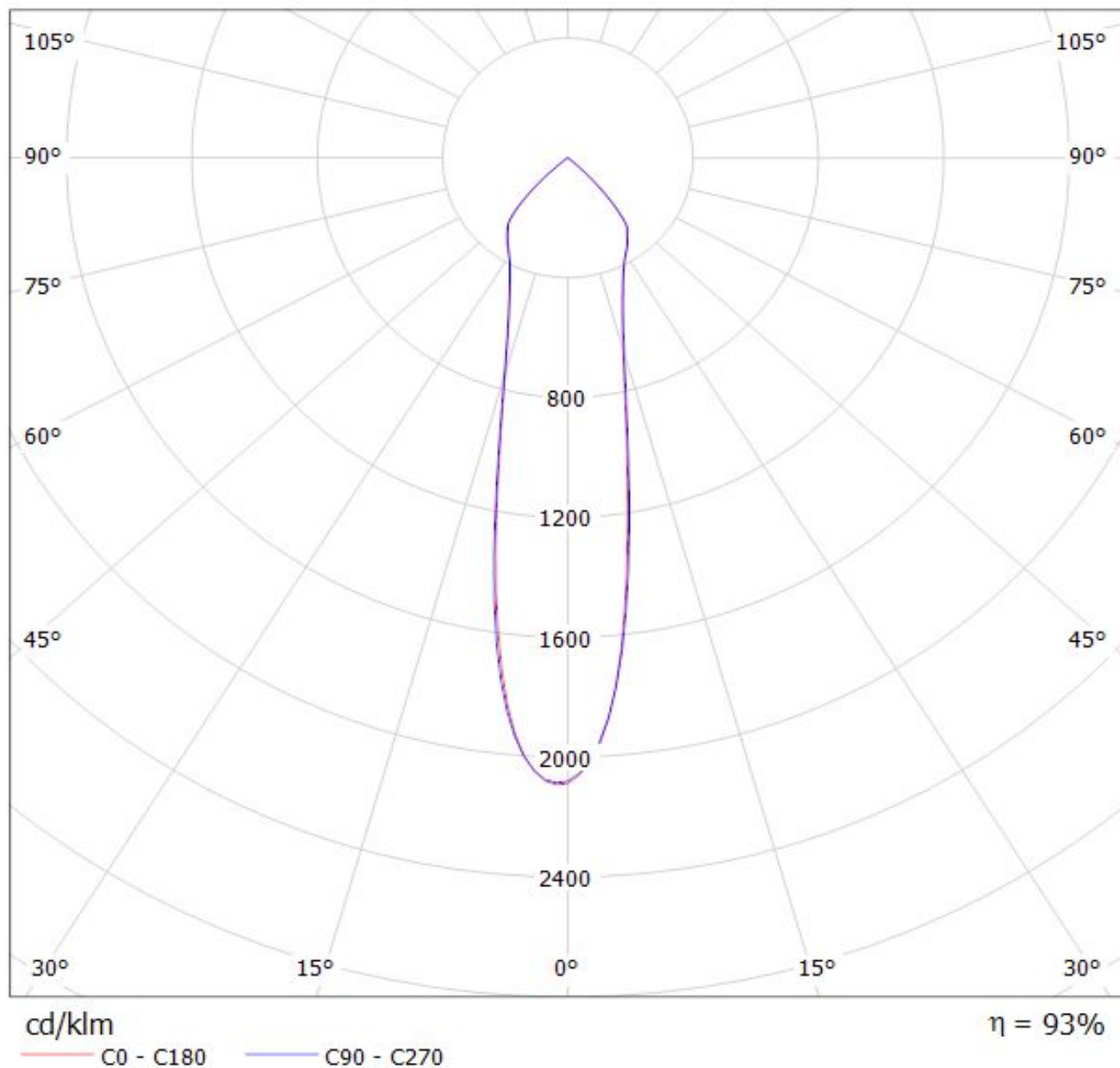

Luminaire: LEDiL Oy F13325_ANGELINA-S_(PrevaLED_Z4) Eff:94%

Lamps: 1 x Osram_PrevaLED_CORE_Z4_(PL-CORE-3000-830-Z4)_1423.93lm@250mA_P=10.7652W_I=249.9mA

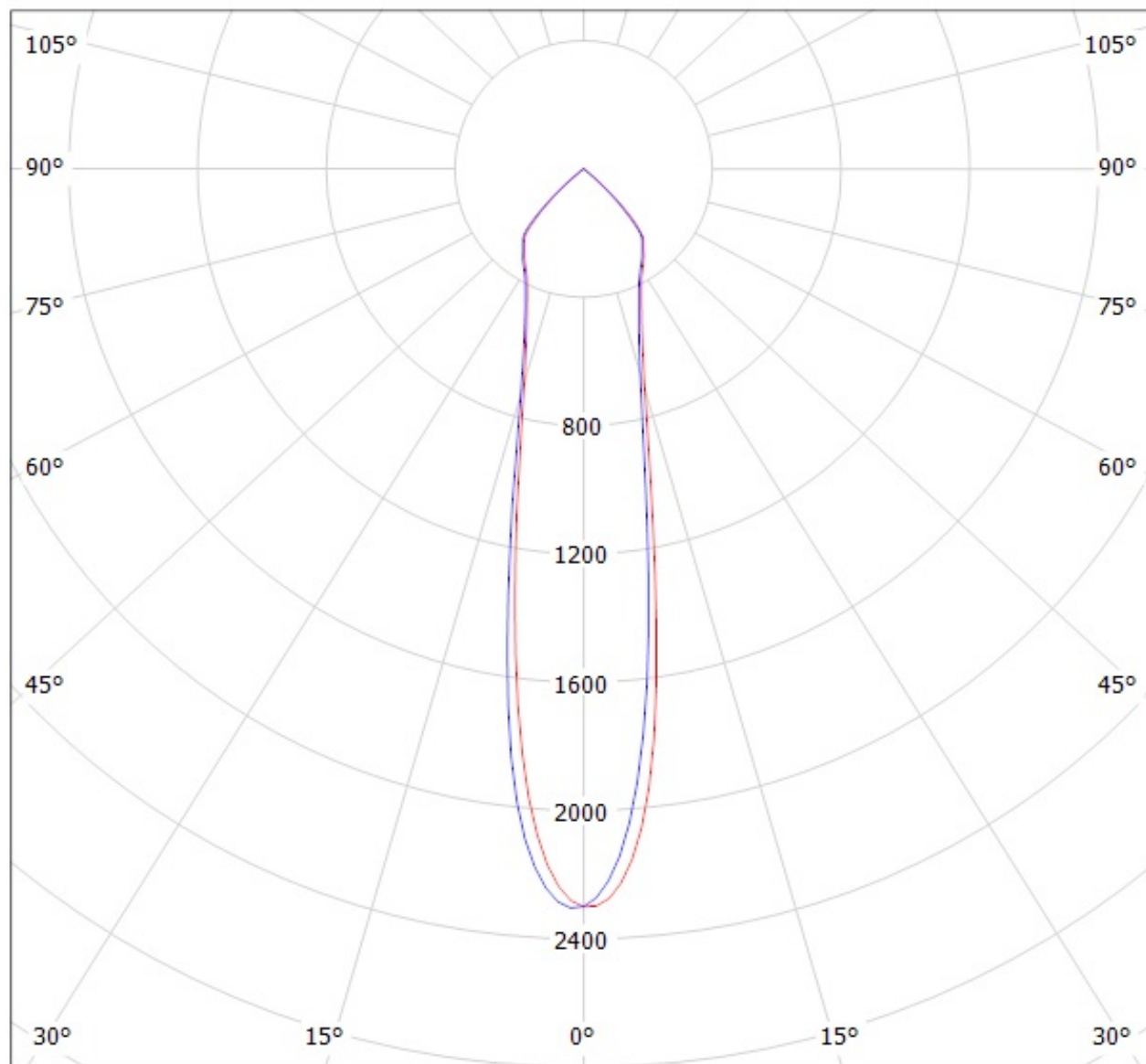

cd/klm

— C0 - C180

— C90 - C270

$\eta = 94\%$

Luminaire: LEDiL Oy F13325_ANGELINA-S_(SOLERIQ_P13)

Lamps: 1 x SOLERIQ_P13_(GW_MAGMB1.EM)_1038.25lm@250mA_CCT=3000K_P=8.77223W_I=249.8mA

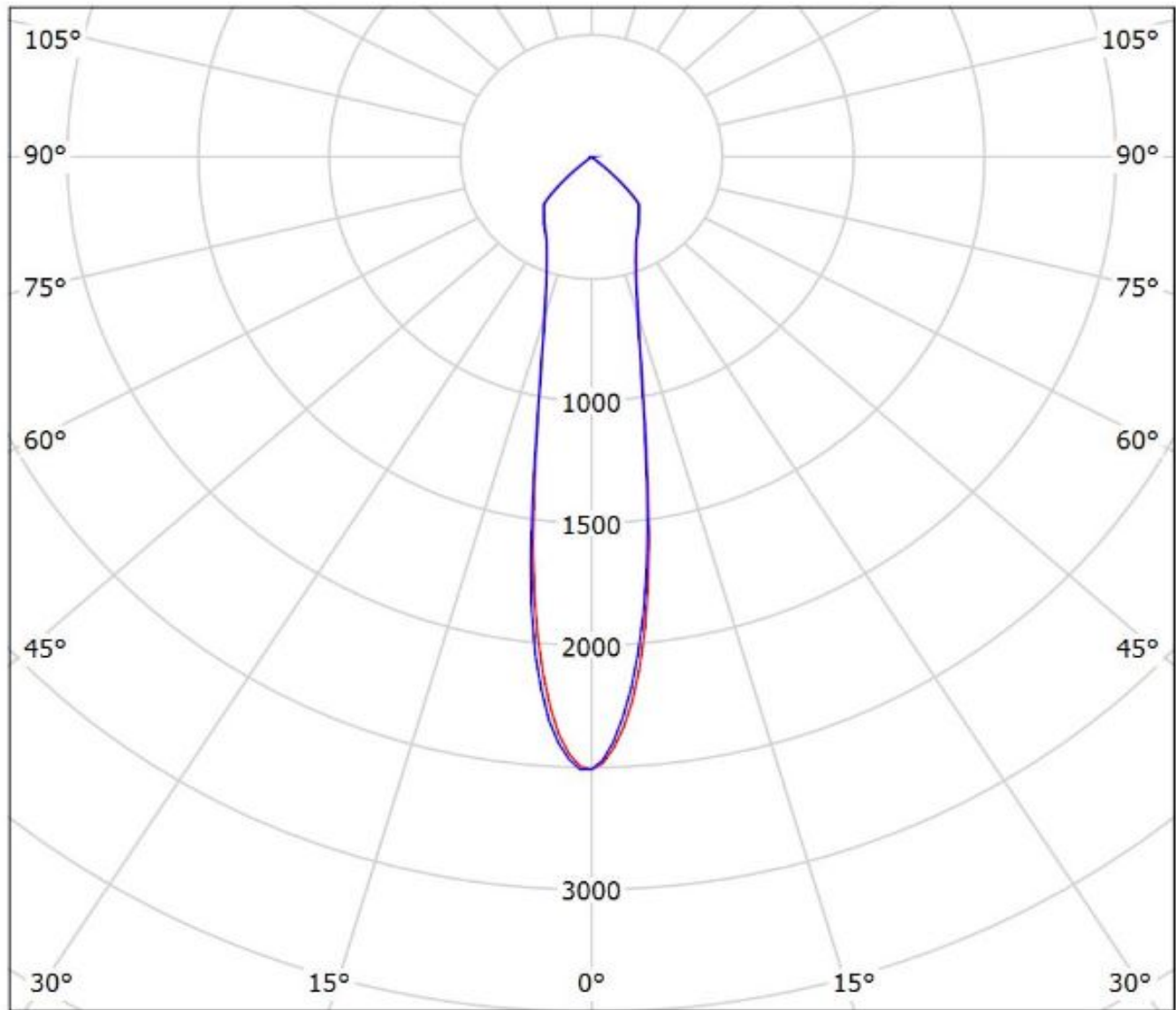

cd/klm

— C0 - C180 — C90 - C270

$\eta = 93\%$

Luminaire: Ledil F13325_ANGELINA-S_(S13_Gen2+TE)

Lamps: 1 x Soleriq_S13_Gen2+_2213254-2+_2213194-1_1309.23lm@250mA_P=8.7840W_I=0.250A

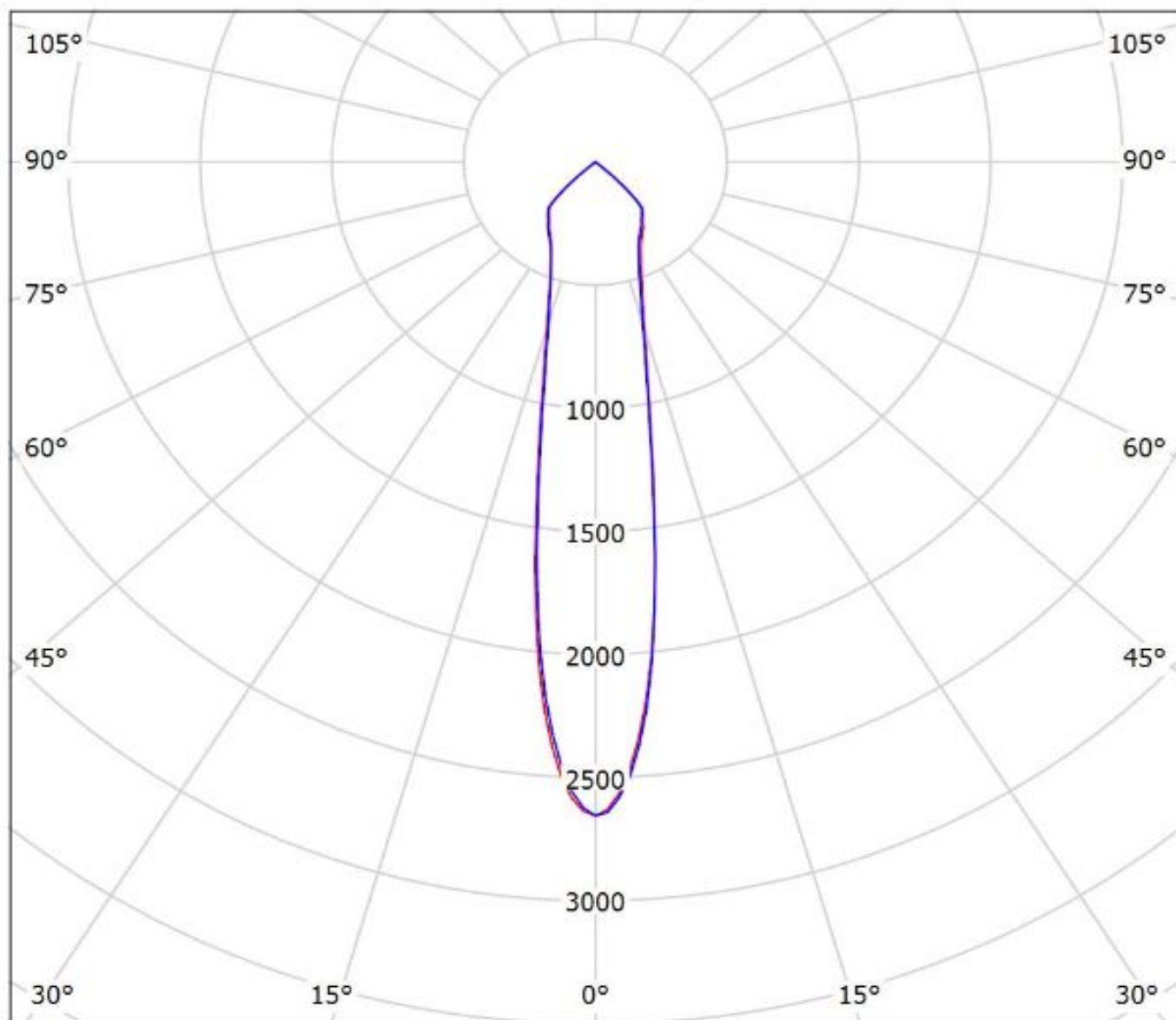

cd/klm

— C0 - C180 — C90 - C270

$\eta = 93\%$

Luminaire: Ledil F13325_ANGELINA-S_(S13_Gen2+IDEAL)

Lamps: 1 x Soleriq_S13_Gen2+_50-2103CT+_50-2100AN_1327.38lm@250mA_P=8.7850W_I=0.250A

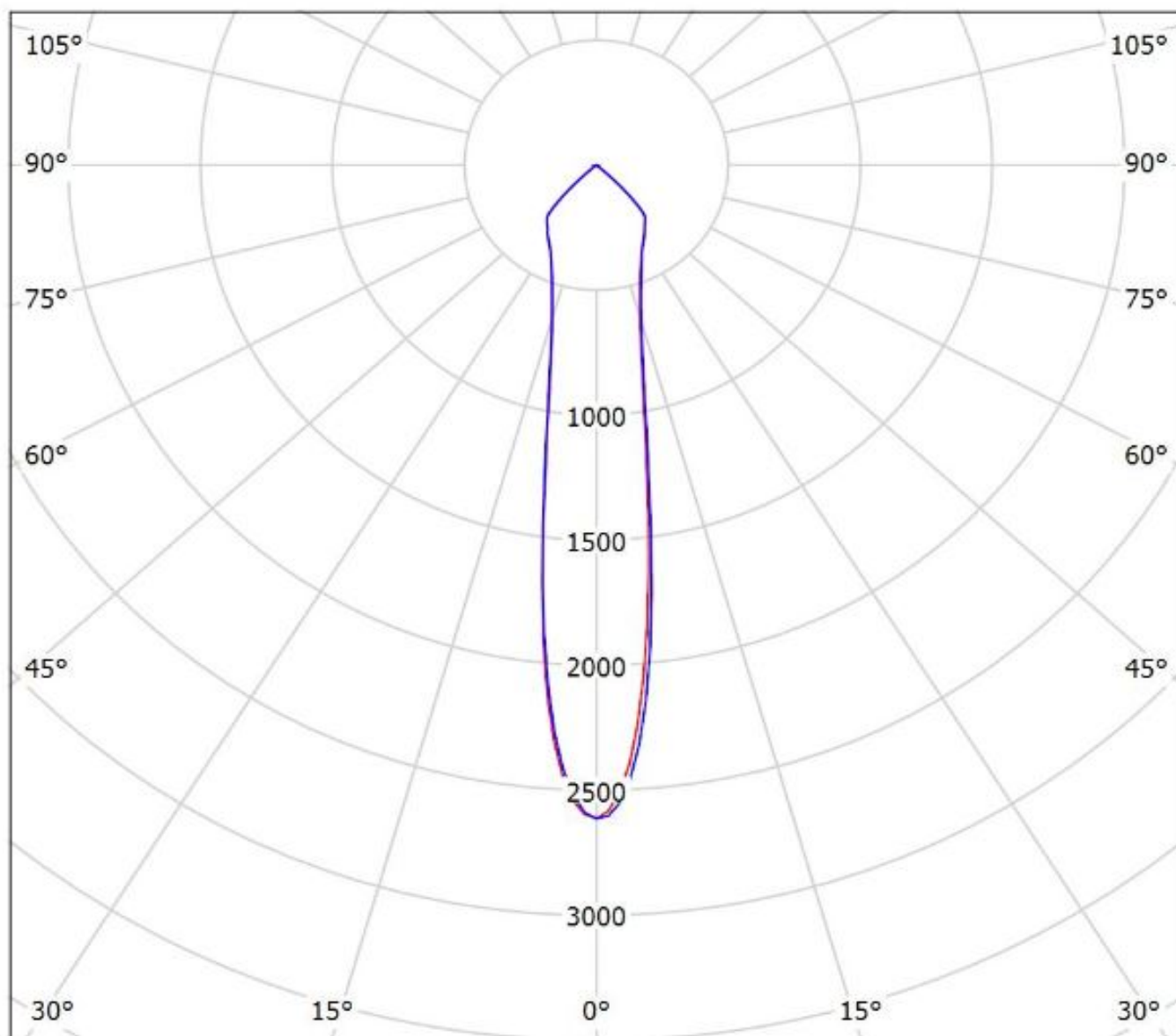

cd/klm

— C0 - C180

— C90 - C270

$\eta = 91\%$

Luminaire: LEDiL Oy F13325_ANGELINA-S_(FORTIMO_2000) Eff.90.7%

Lamps: 1 x PHILIPS Fortimo LED SLM 2000 23W/930 L19 G3 665.774lm@250mA CCT=3000K P=6W I=250mA

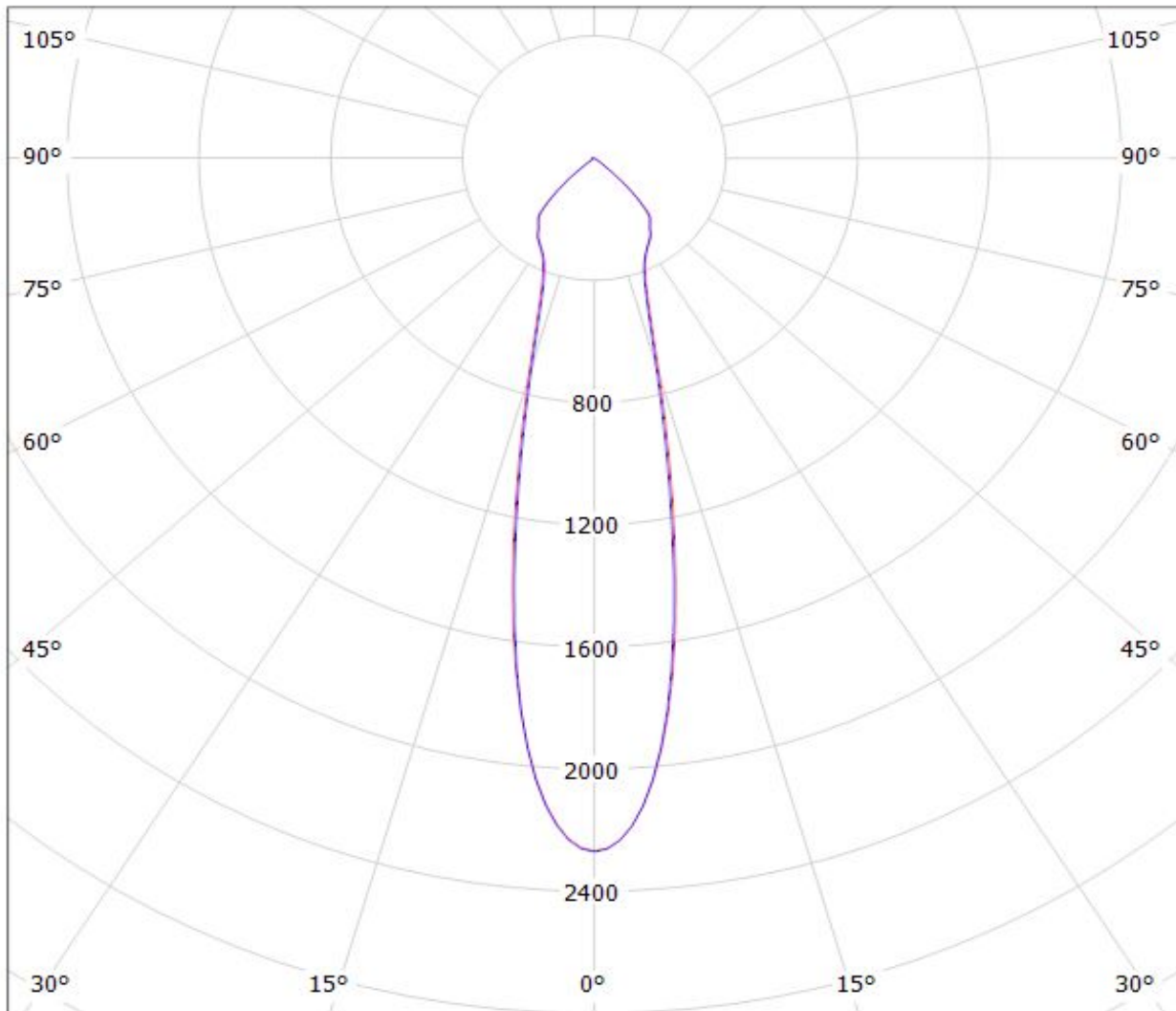

cd/klm

— C0 - C180

— C90 - C270

$\eta = 91\%$

Luminaire: LEDiL Oy F13325_ANGELINA-S_(FORTIMO_3000) Eff.90.9%

Lamps: 1 x PHILIPS Fortimo LED SLM 3000 28W/830 L19 G3 1046.76lm@250mA CCT=3000K P=9W I=250mA

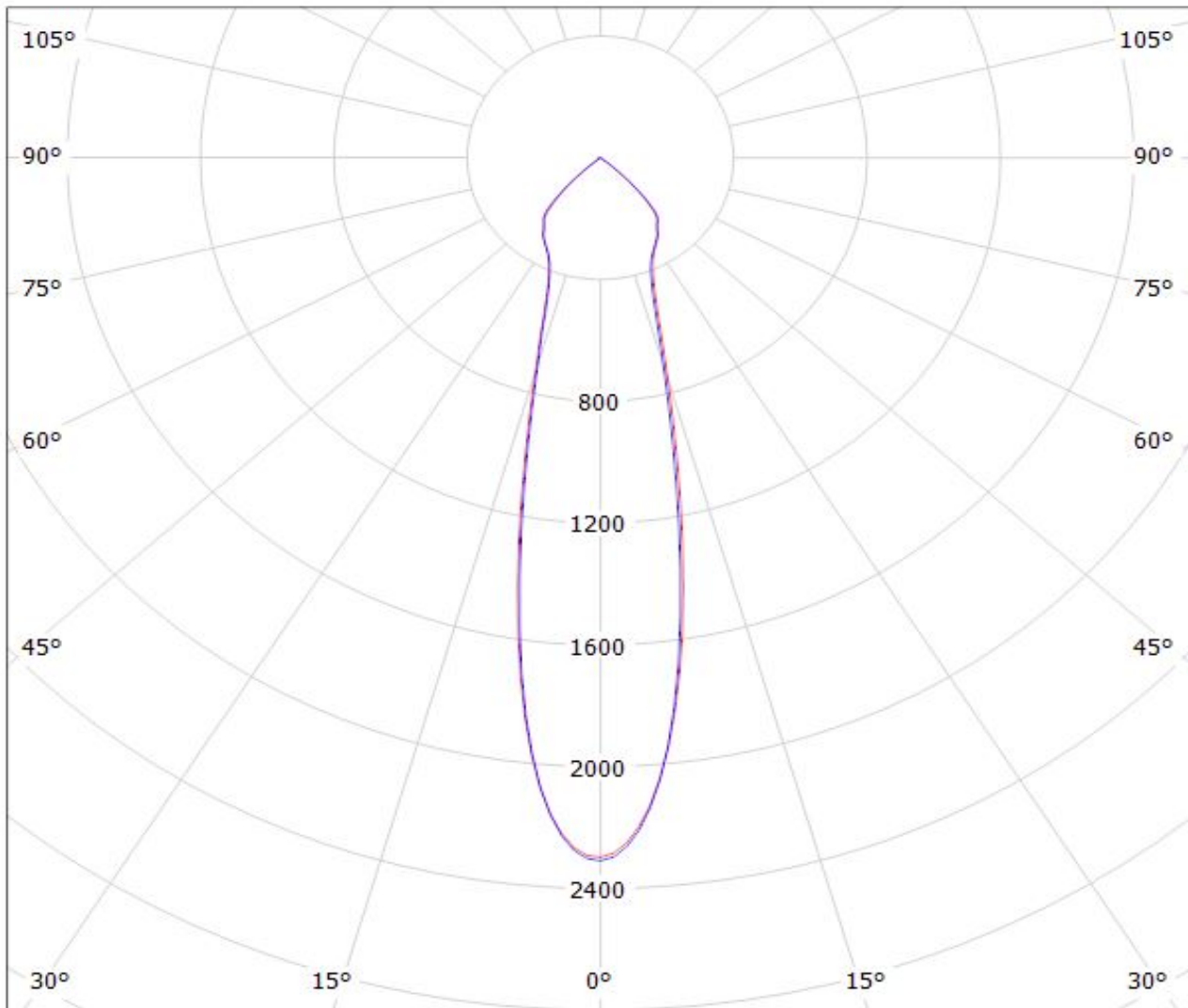

cd/klm

$\eta = 91\%$

— C0 - C180 — C90 - C270

Luminaire: LEDiL Oy F13325_ANGELINA-S_(FORTIMO_4500) Eff.89.2%
Lamps: 1 x PHILIPS Fortimo 4500 1197lm@250mA I:250mA P:10.8W

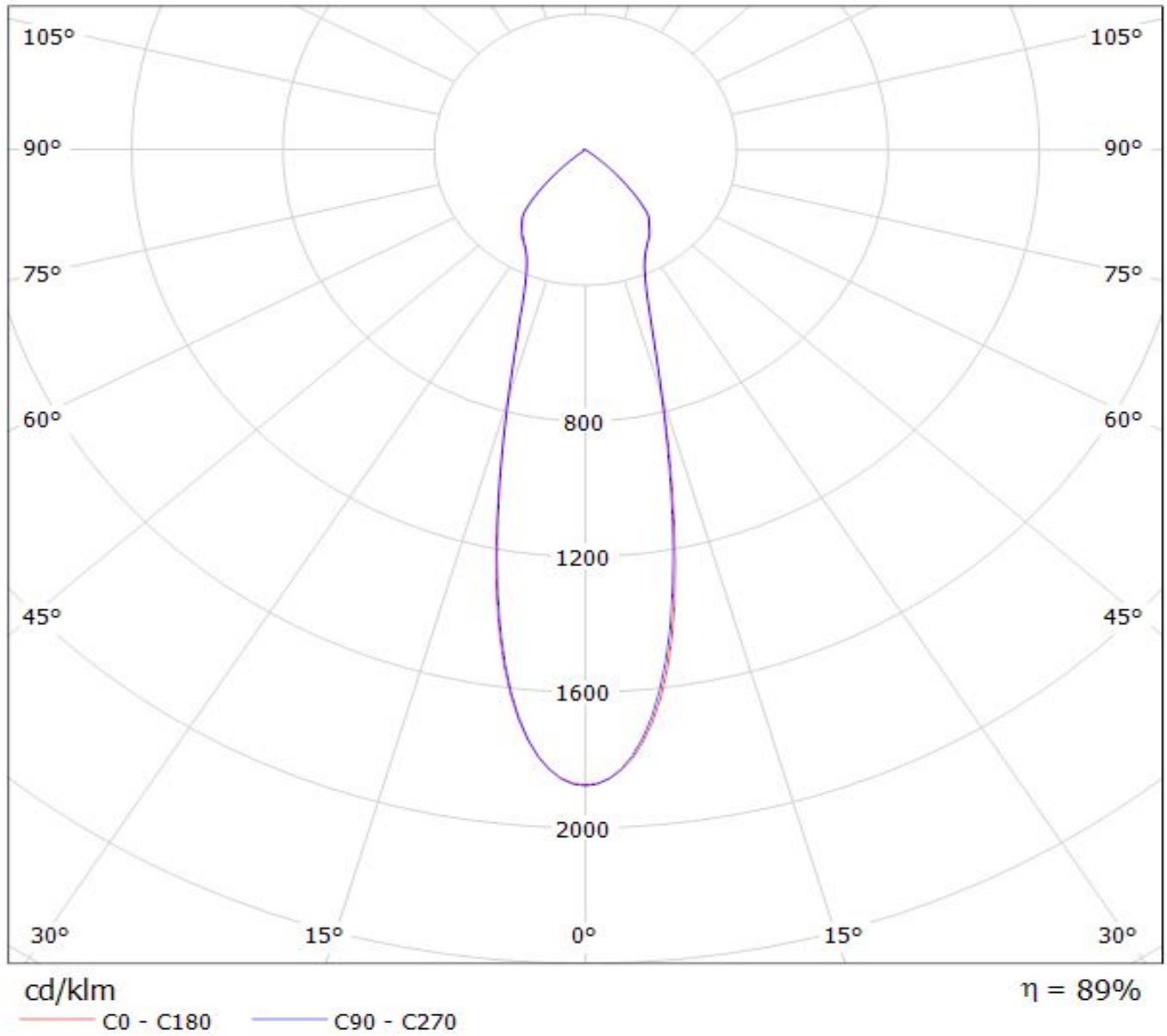

Luminaire: LEDiL Oy F13325_ANGELINA-S_(Fortimo LED SLM 1100 lm 830 L9 G4)
Lamps: 1 x Fortimo LED SLM 1100 lm 830 L9 G4_1021.27lm@250mA_P=9.2431W_I=0.2498A

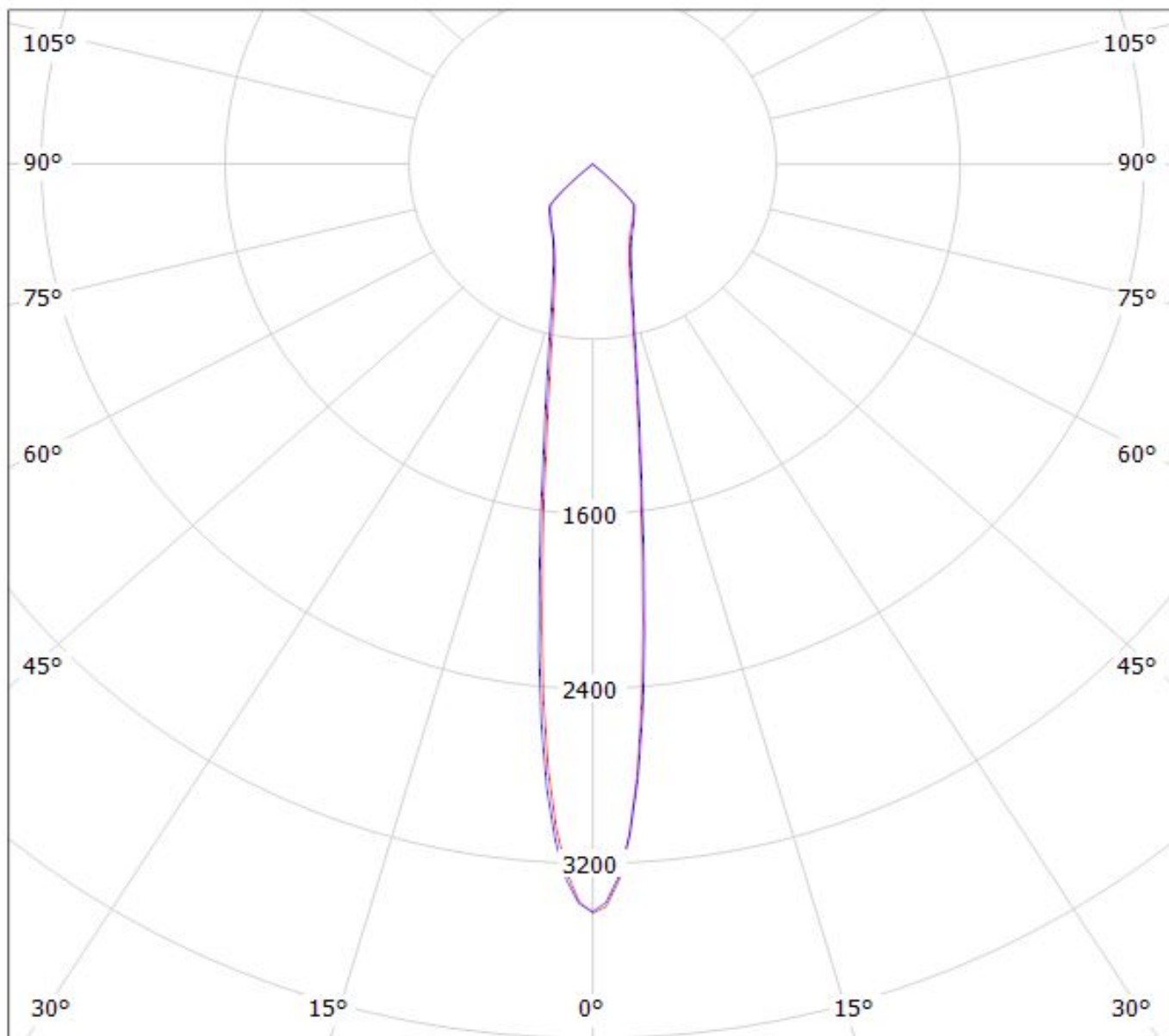

cd/klm

— C0 - C180 — C90 - C270

$\eta = 94\%$

Luminaire: LEDiL Oy F13325_ANGELINA-S_(Fortimo LED SLM L13 G4)

Lamps: 1 x Fortimo LED SLM L13 G4_1030.19lm@250mA_P=8.38104W_I=0.2498A

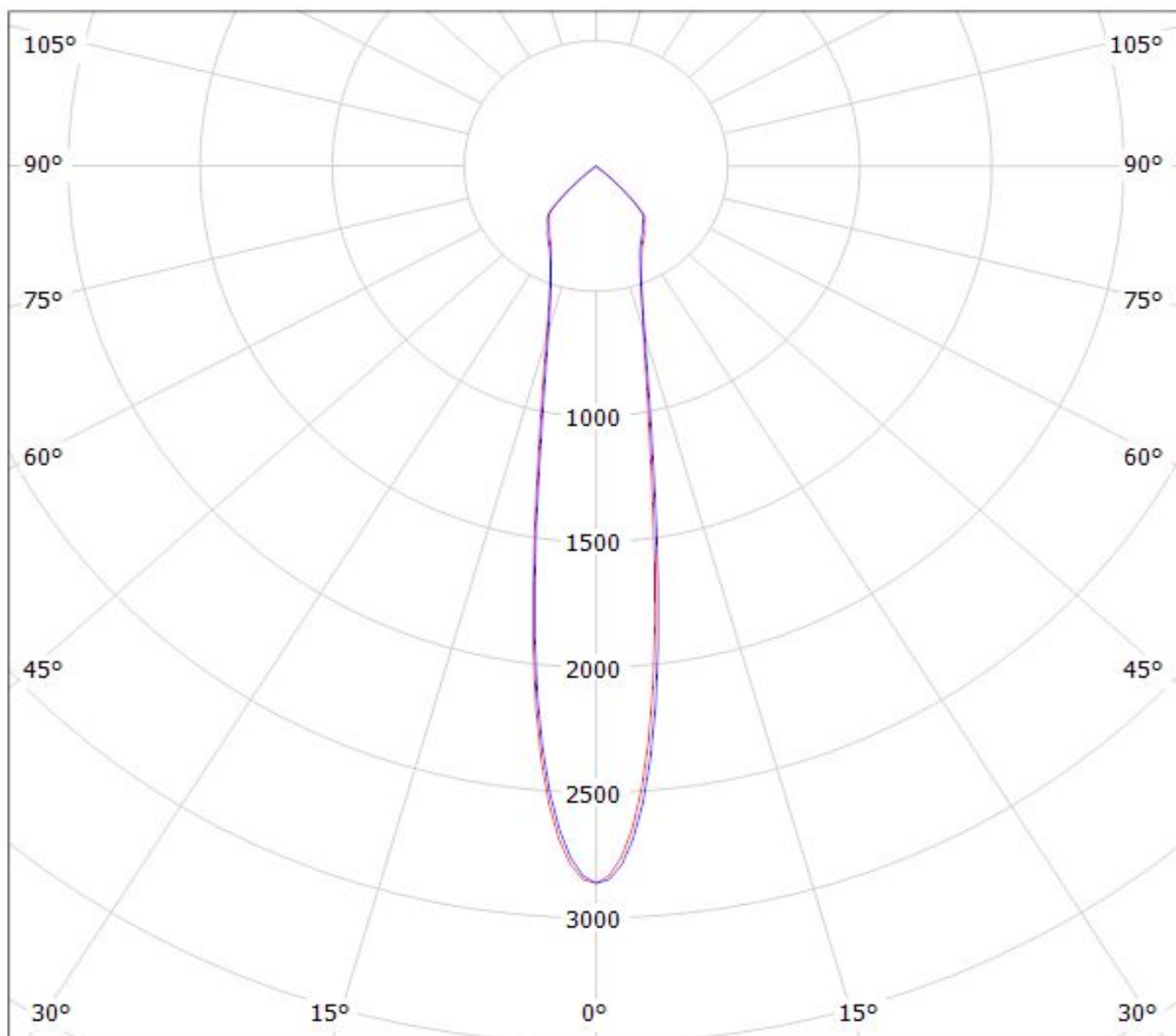

cd/klm

— C0 - C180

— C90 - C270

$\eta = 94\%$

Luminaire: LEDiL Oy F13325_ANGELINA-S_(Fortimo LED SLM L15 G4)

Lamps: 1 x Fortimo LED SLM L15 G4_1116.47lm@250mA_P=8.21168W_I=0.2498A

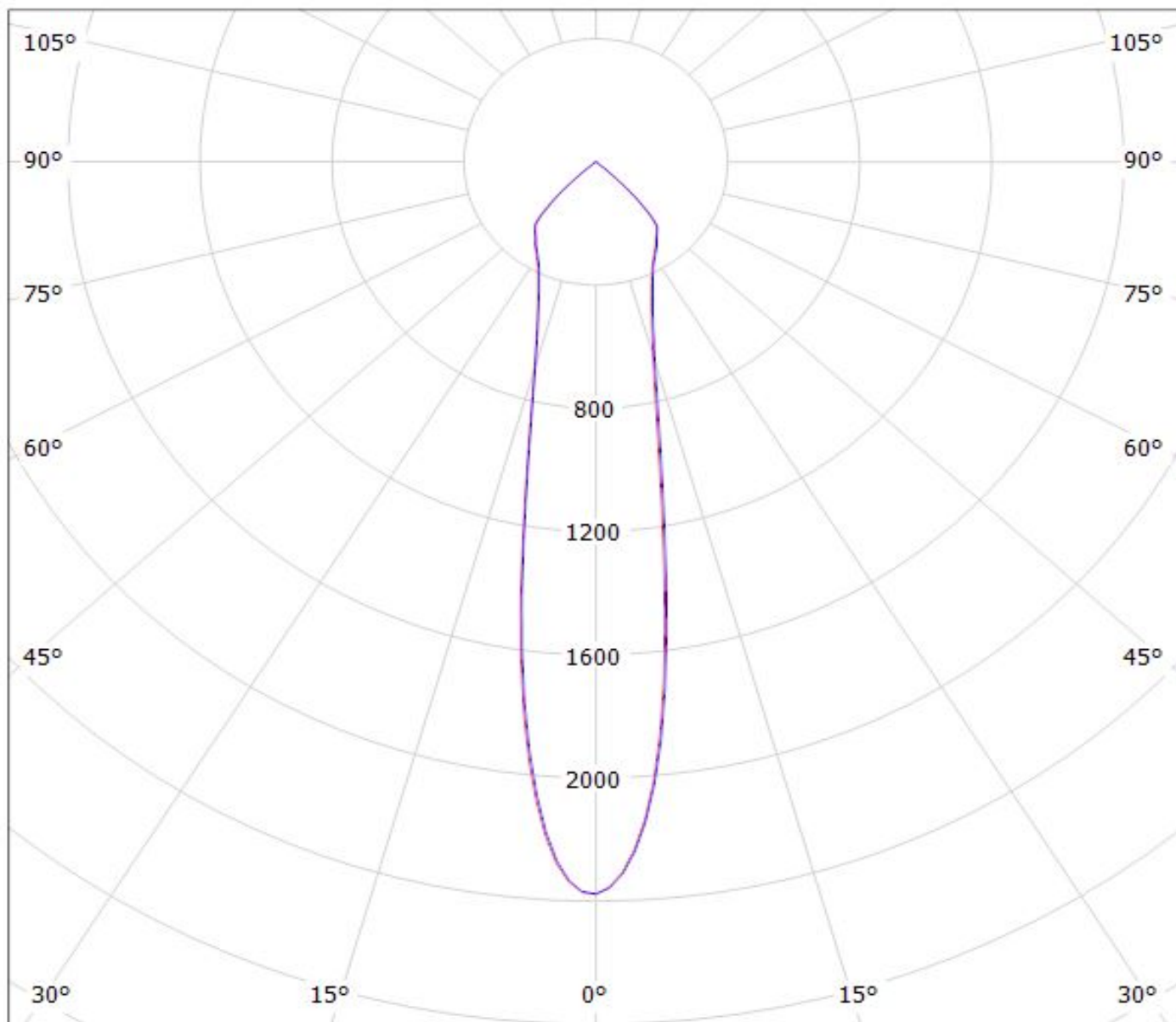

cd/klm

$\eta = 93\%$

— C0 - C180

— C90 - C270

Luminaire: LEDiL Oy F13325_ANGELINA-S_(Fortimo LED SLM L19 G4)
Lamps: 1 x Fortimo LED SLM L19 G4_1114.89lm@250mA_P=8.04906W_I=0.2498A

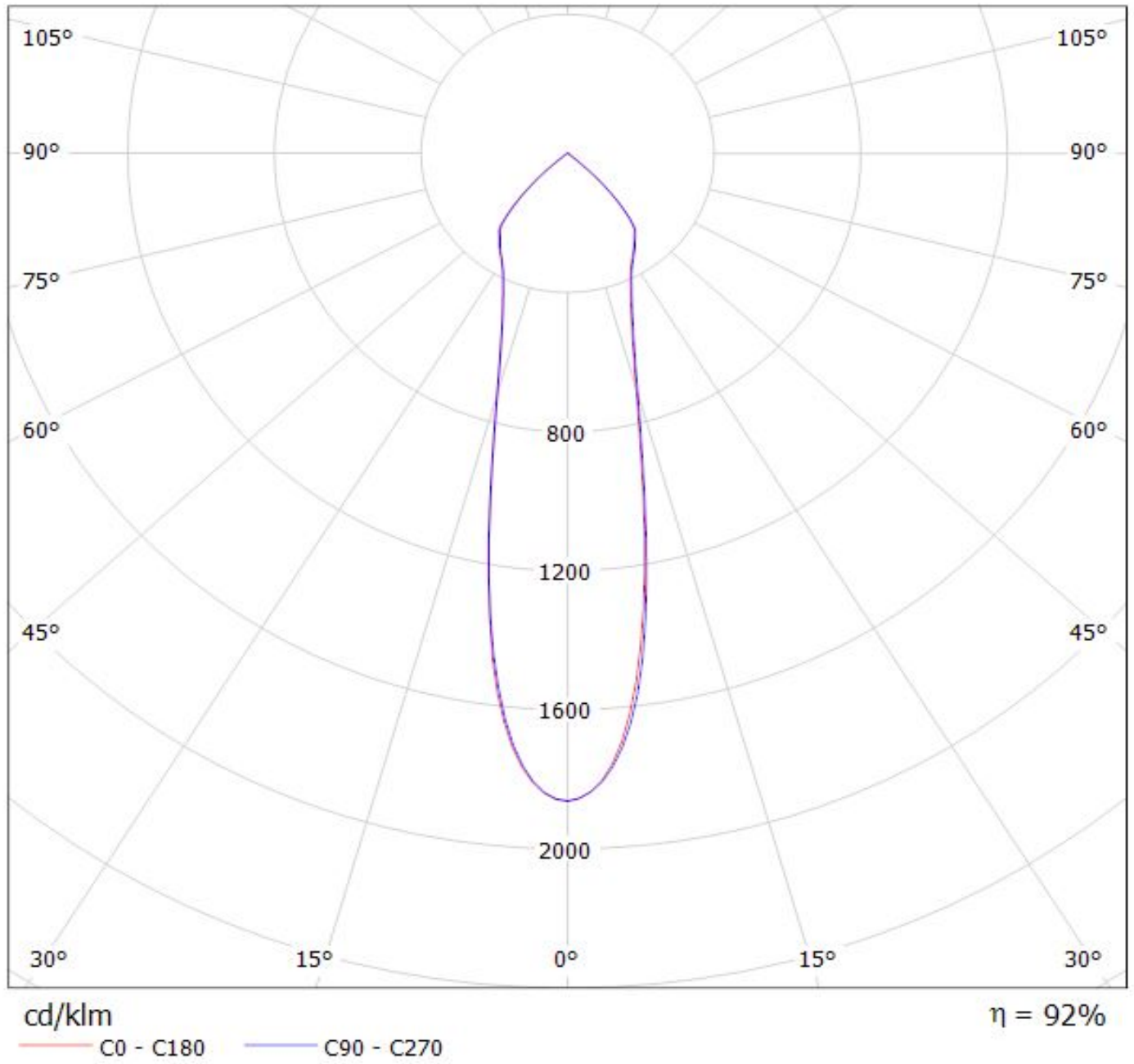

Luminaire: LEDiL Oy F13325_ANGELINA-S_(SLM-G5-LES-9)_(Z50-Optic-Clip)
Lamps: 1 x Fortimo_SLM-G5-LES-9_1182.49lm@250mA_P=8.5848W_I=0.250A

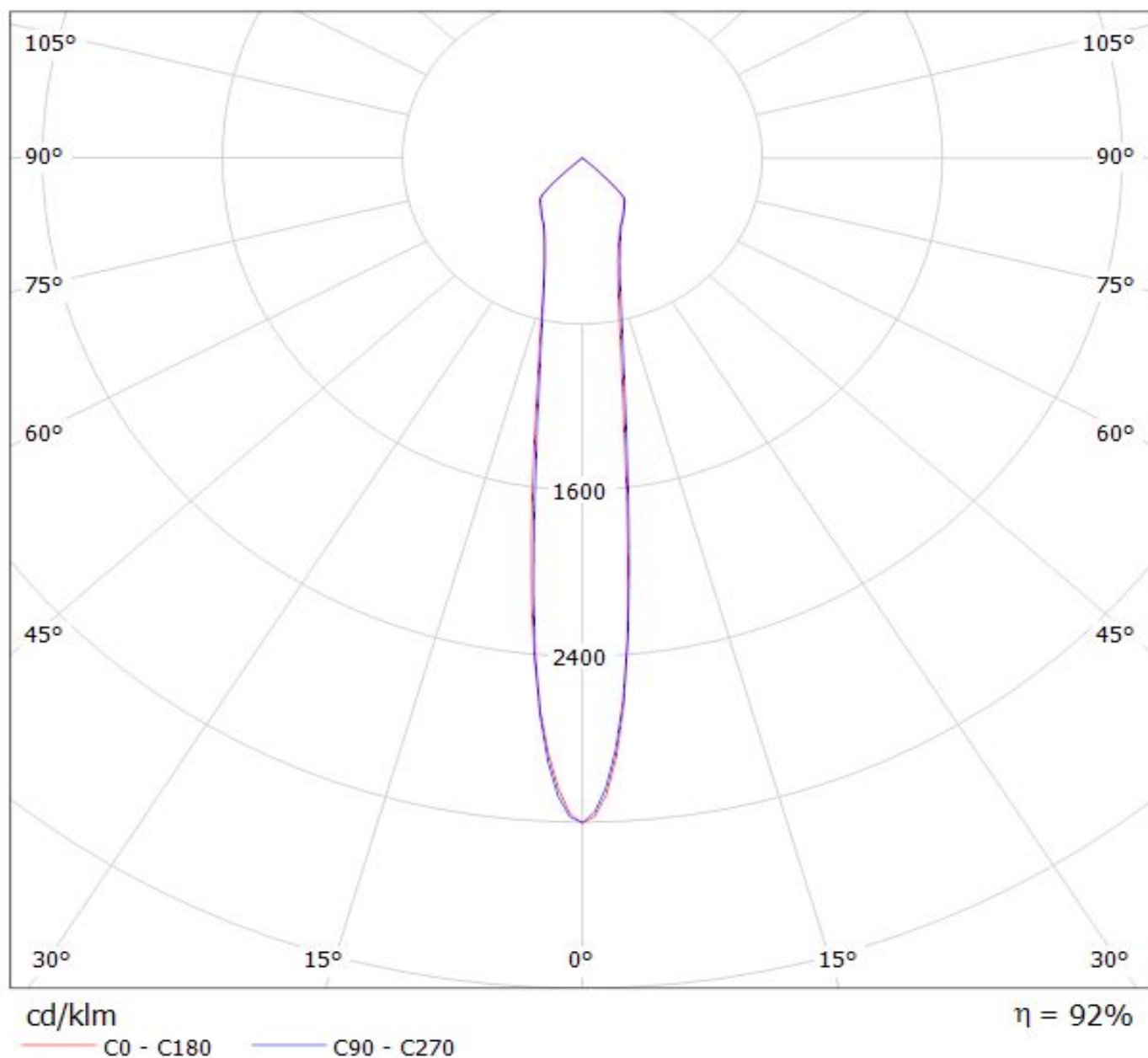

Luminaire: LEDiL Oy F13325_ANGELINA-S_(SLM-G5_LES-15)

Lamps: 1 x Fortimo_SLM-G5_LES-15_1257.61lm@250mA_P=8.1569W_I=0.250A

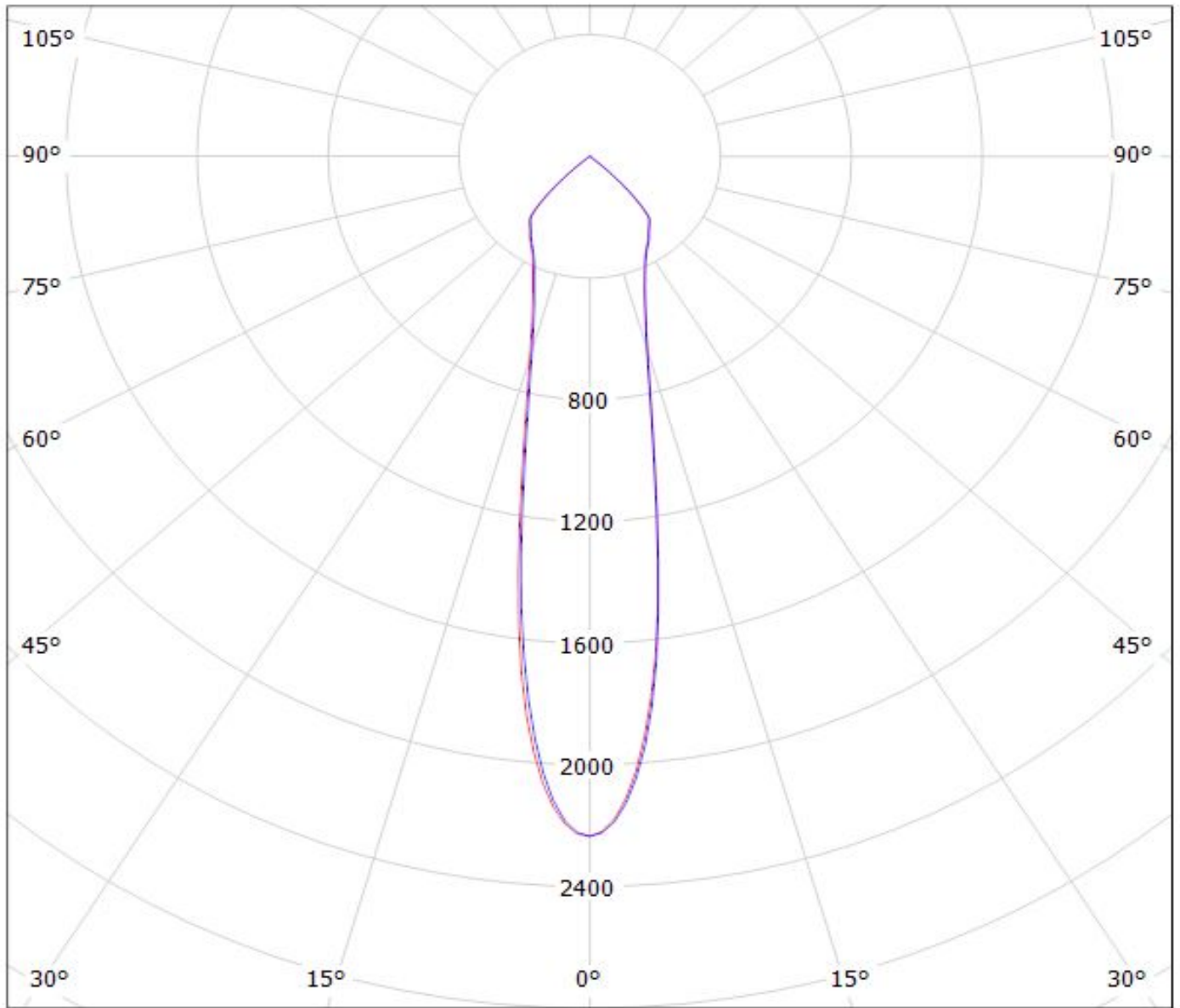

cd/klm

— C0 - C180

— C90 - C270

$\eta = 91\%$

Luminaire: LEDiL Oy F13325_ANGELINA-S-WAS_(SLM-G5_LES-19)_ (Z50_Optic_Clip)
Lamps: 1 x Fortimo_SLM-G5_LES-19_1397.58lm@250mA_P=8.0385W_I=0.250A

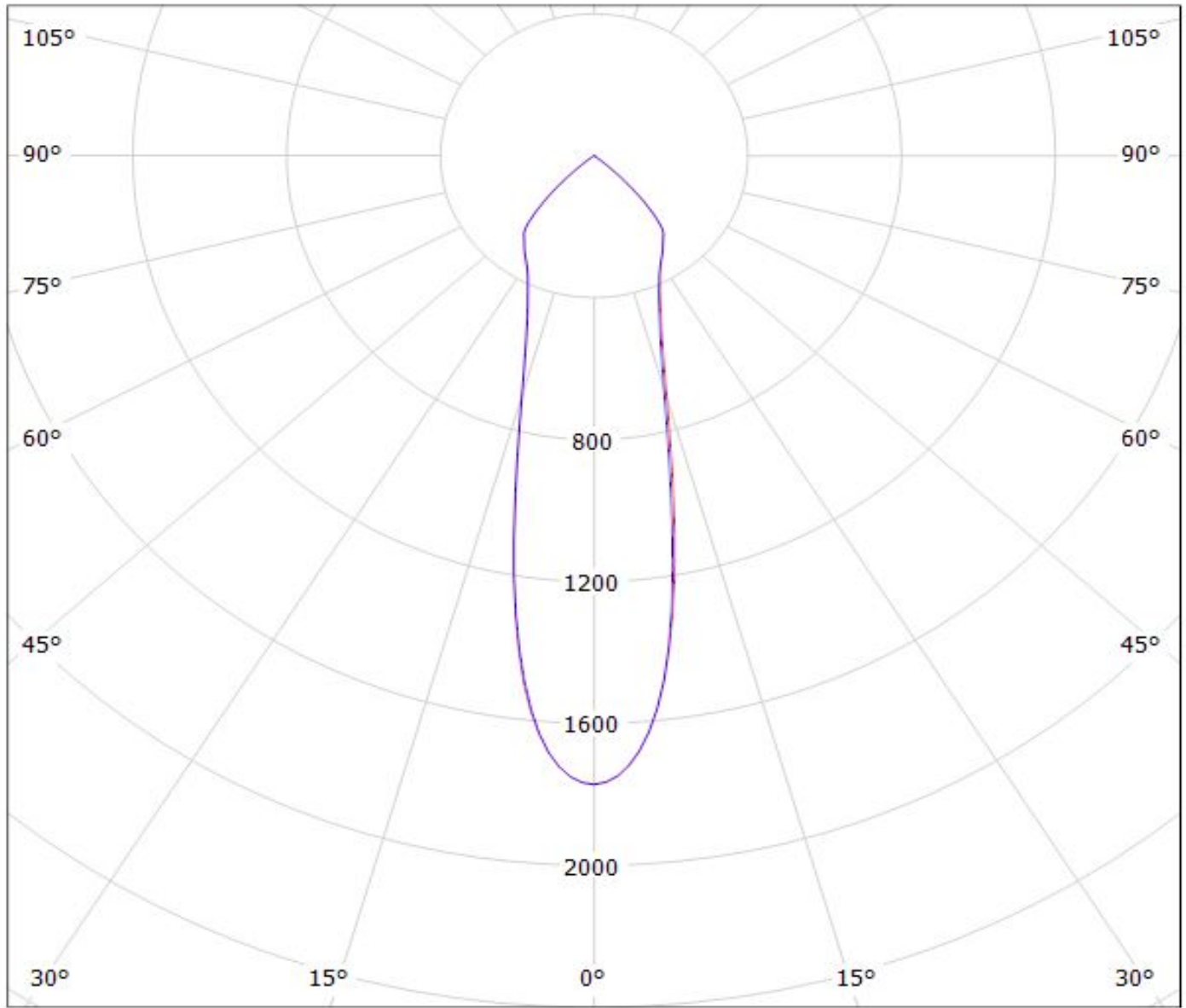

cd/klm

— C0 - C180

— C90 - C270

$\eta = 90\%$

Luminaire: LEDiL Oy F13325_ANGELINA-S_(SLM-G5_LES-13)_(Z50-Optic-Clip)
Lamps: 1 x Fortimo_SLM-G5_LES-13_1300.47lm@250mA_P=8.4010W_I=0.250A

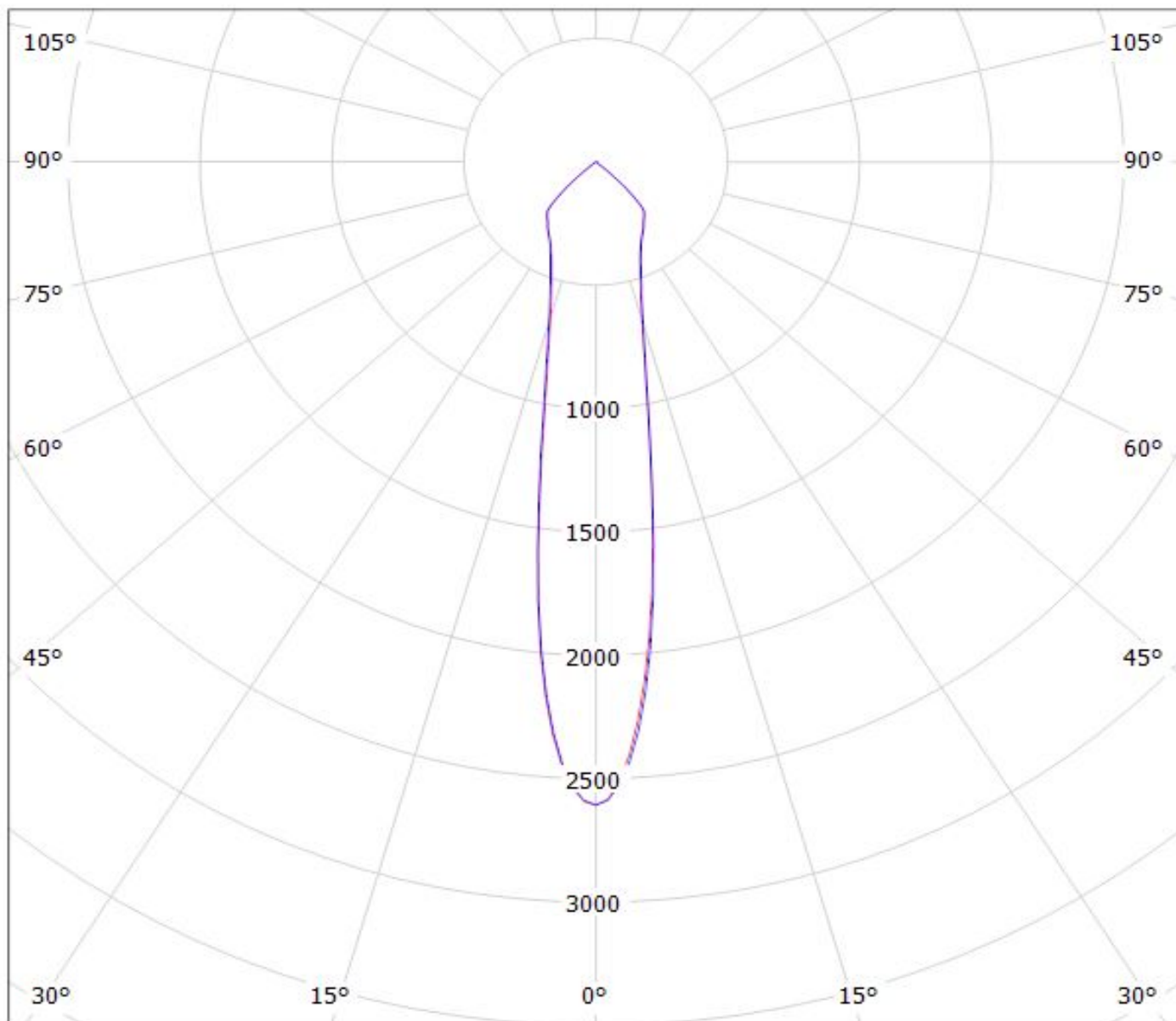

cd/klm

$\eta = 92\%$

— C0 - C180 — C90 - C270

Luminaire: Ledil F13325_ANGELINA-S_(SLM_1211_L19_G6_+TE)

Lamps: 1 x Philips_Fortimo_SLM_1211_L19_G6_Standard_+_TE_OPTIC_CLIP_Z50_TYPE1:_2213194-1_1146.84lm@250mA_P=8.13175W_I=0.25A

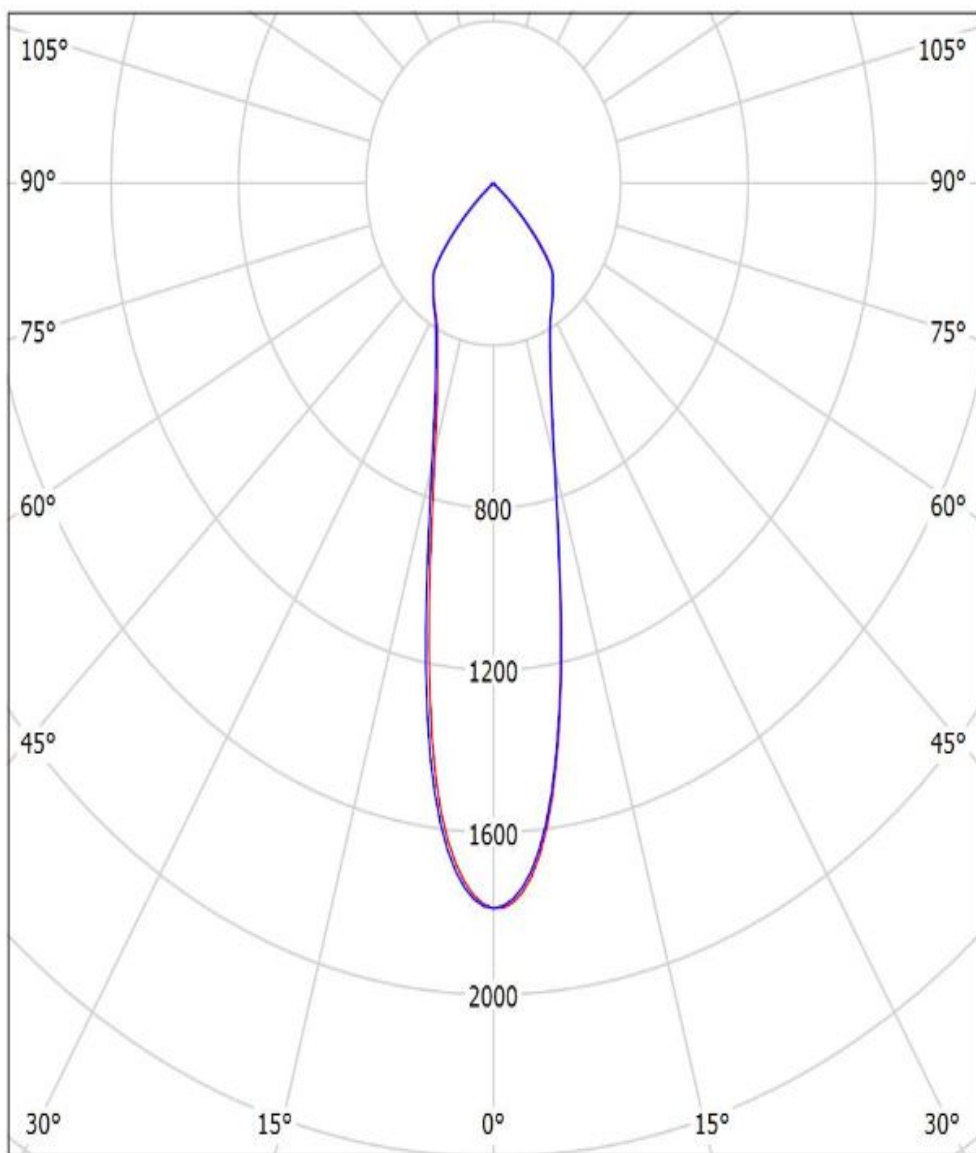

cd/klm

— C0 - C180 — C90 - C270

$\eta = 92\%$

Luminaire: LEDiL Oy F13325_ANGELINA-S_(COB-LC026B) Eff.93.5%

Lamps: 1 x SAMSUNG_COB-LC026B_(SPHWWTHDNC25YHV52F)_1136.23lm@250mA_P=8.23191W_I=249.8mA

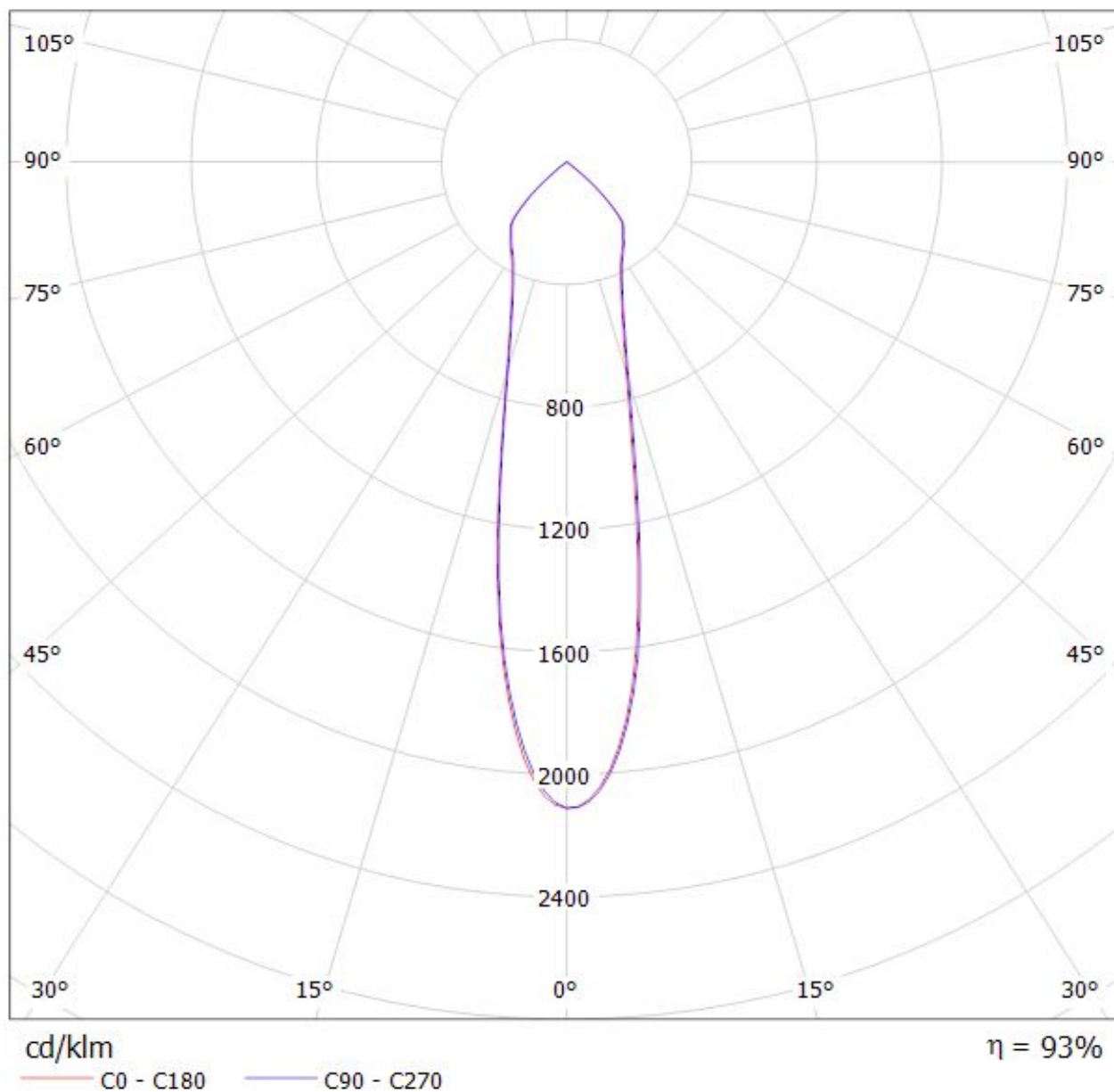

Luminaire: Ledil F13325_ANGELINA-S_(LC040C+TE)

Lamps: 1 x Samsung_LC040C+_2213382-2+_2213194-1_1194.16lm@250mA_CCT=4000K_P=8.137W

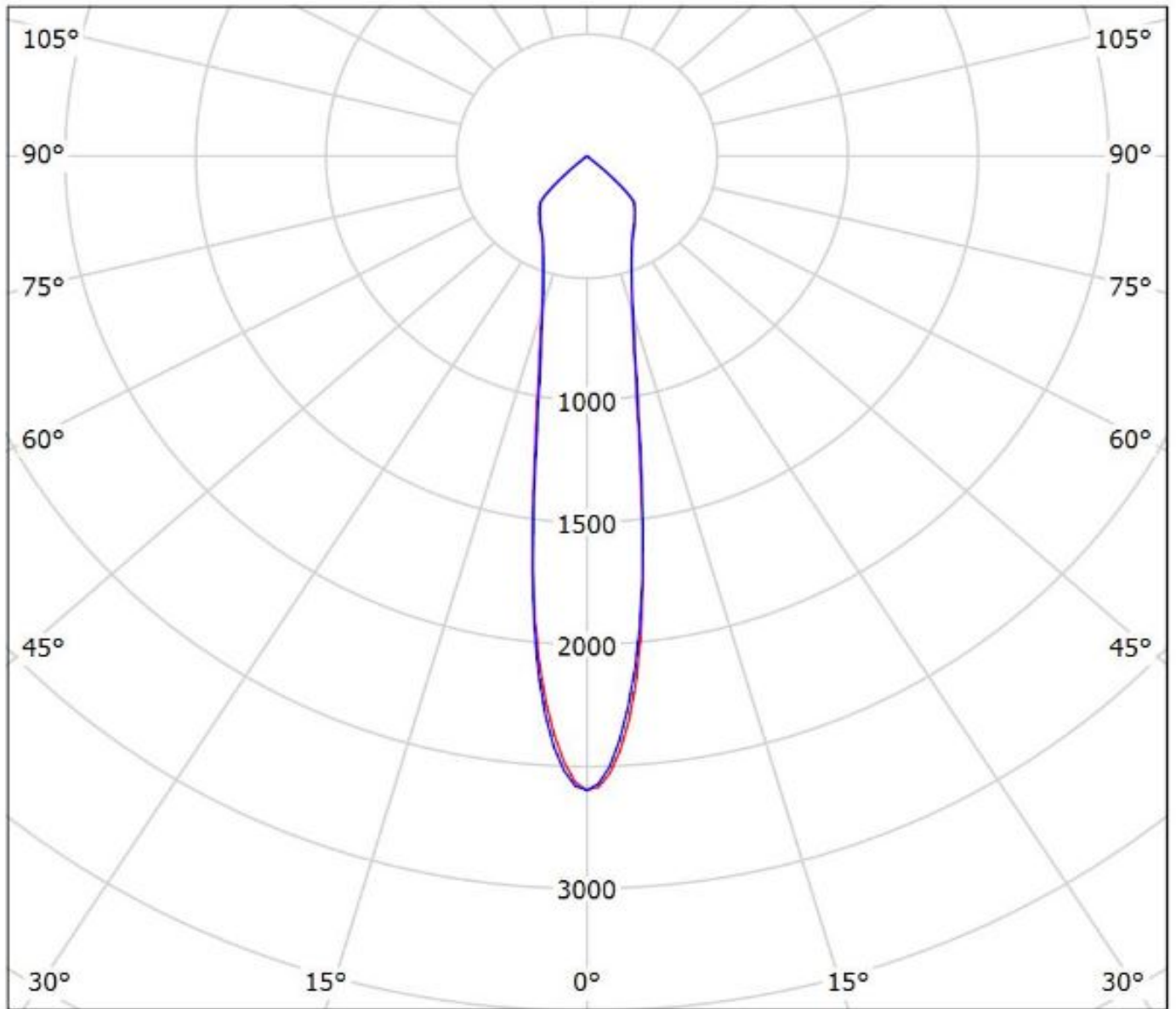

cd/klm

— C0 - C180

— C90 - C270

$\eta = 92\%$

Luminaire: LEDiL Oy F13325_ANGELINA-S_(MegaZenigata) Eff.92.3%
Lamps: 1 x MegaZenigata_GW6DME (518.495lm@100mA)

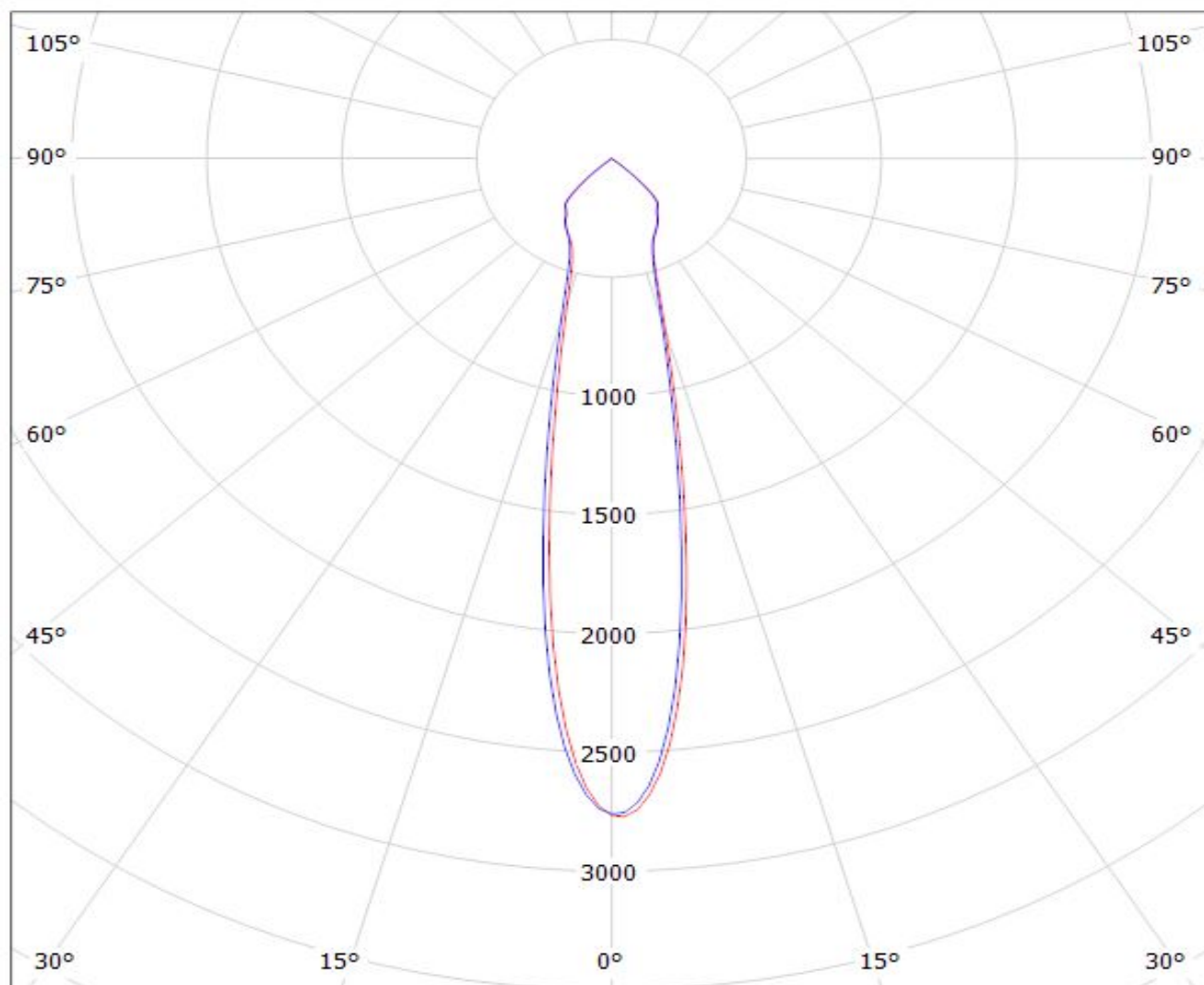

cd/klm

$\eta = 92\%$

— C0 - C180 — C90 - C270

Luminaire: LEDiL Oy F13325_ANGELINA-S_(MEGAZENIGATA) Eff.93.7%

Lamps: 1 x SHARP_MEGAZENIGATA_(GW6DME30NFC)_1238.26lm@250mA_CCT=3000K_P=11.1211W_I=249.8mA

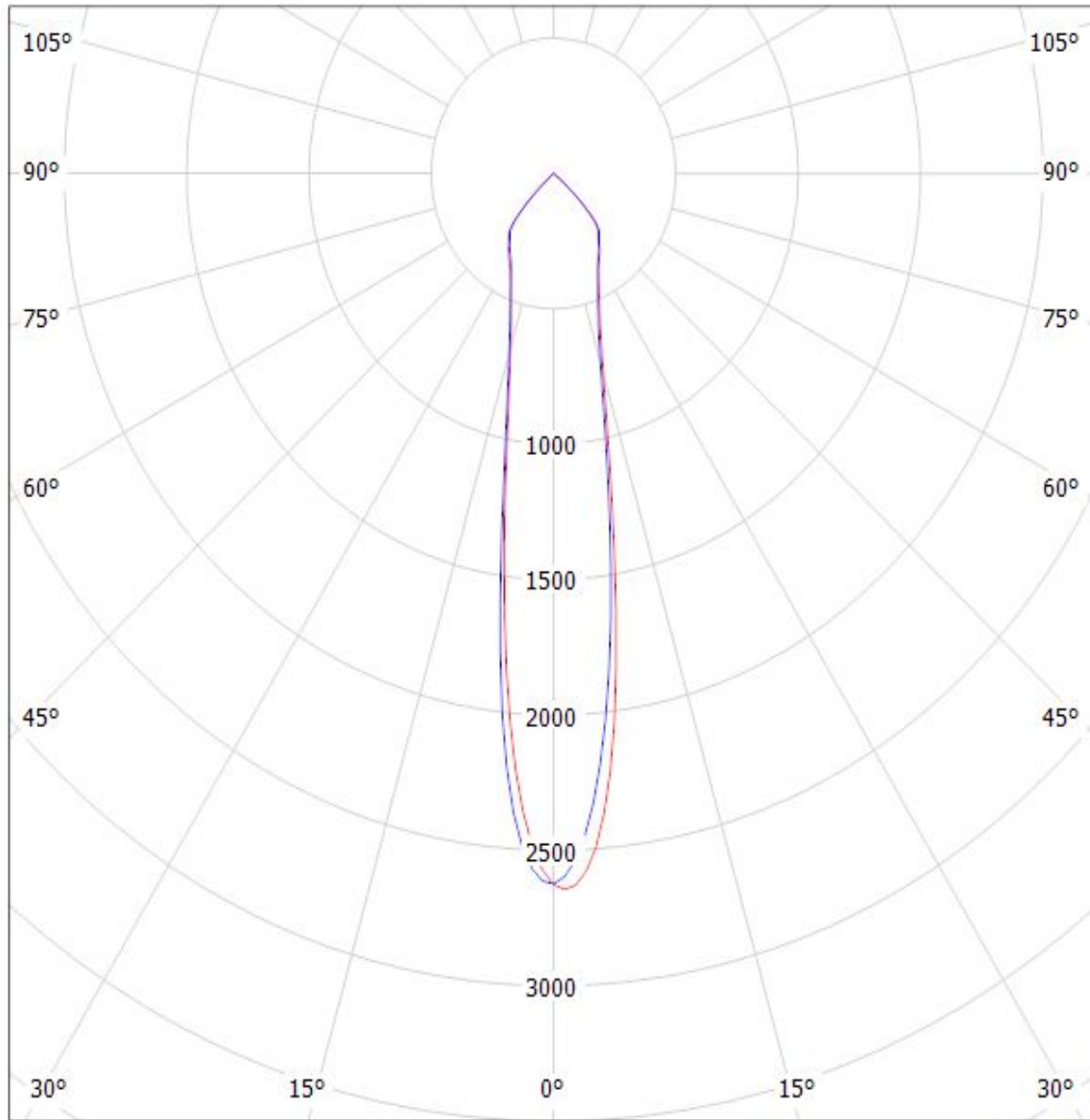

cd/klm

$\eta = 94\%$

— C0 - C180

— C90 - C270

Luminaire: LEDiL Oy F13325_ANGELINA-S_(STARK_SLE_G2_LES19) Eff.92.2%
Lamps: 1 x TRIDONIC STARK SLE G2 LES19 830 CLA 964.643lm@250mA CCT=3000K P=8W I=250mA

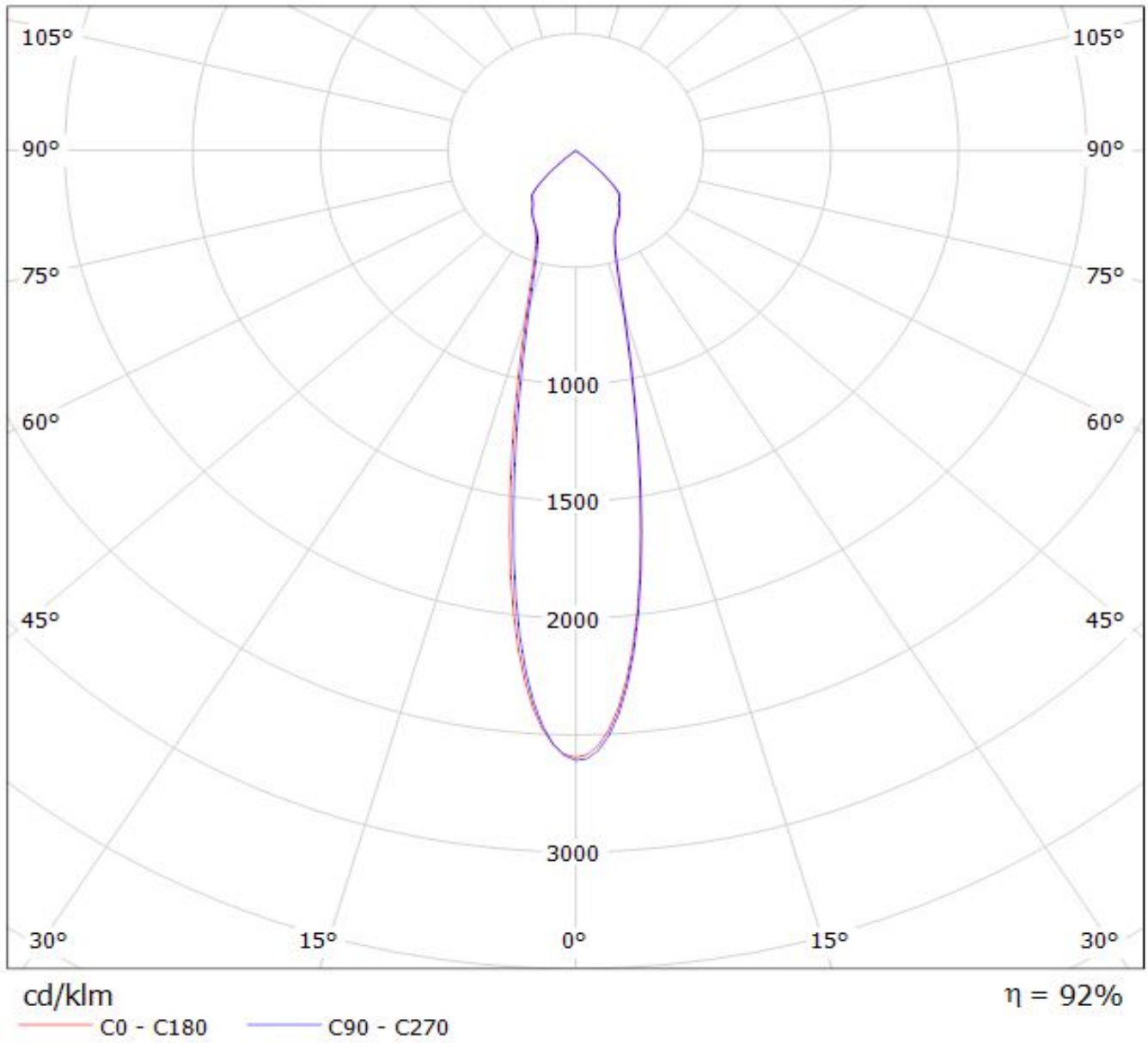

Luminaire: LEDiL Oy F13325_ANGELINA-S_(STARK_SLE_G2_LES23) Eff.90.5%

Lamps: 1 x TRIDONIC STARK SLE G2 LES23 830 CLA 982.731lm@250mA CCT=3000K P=8W I=250mA

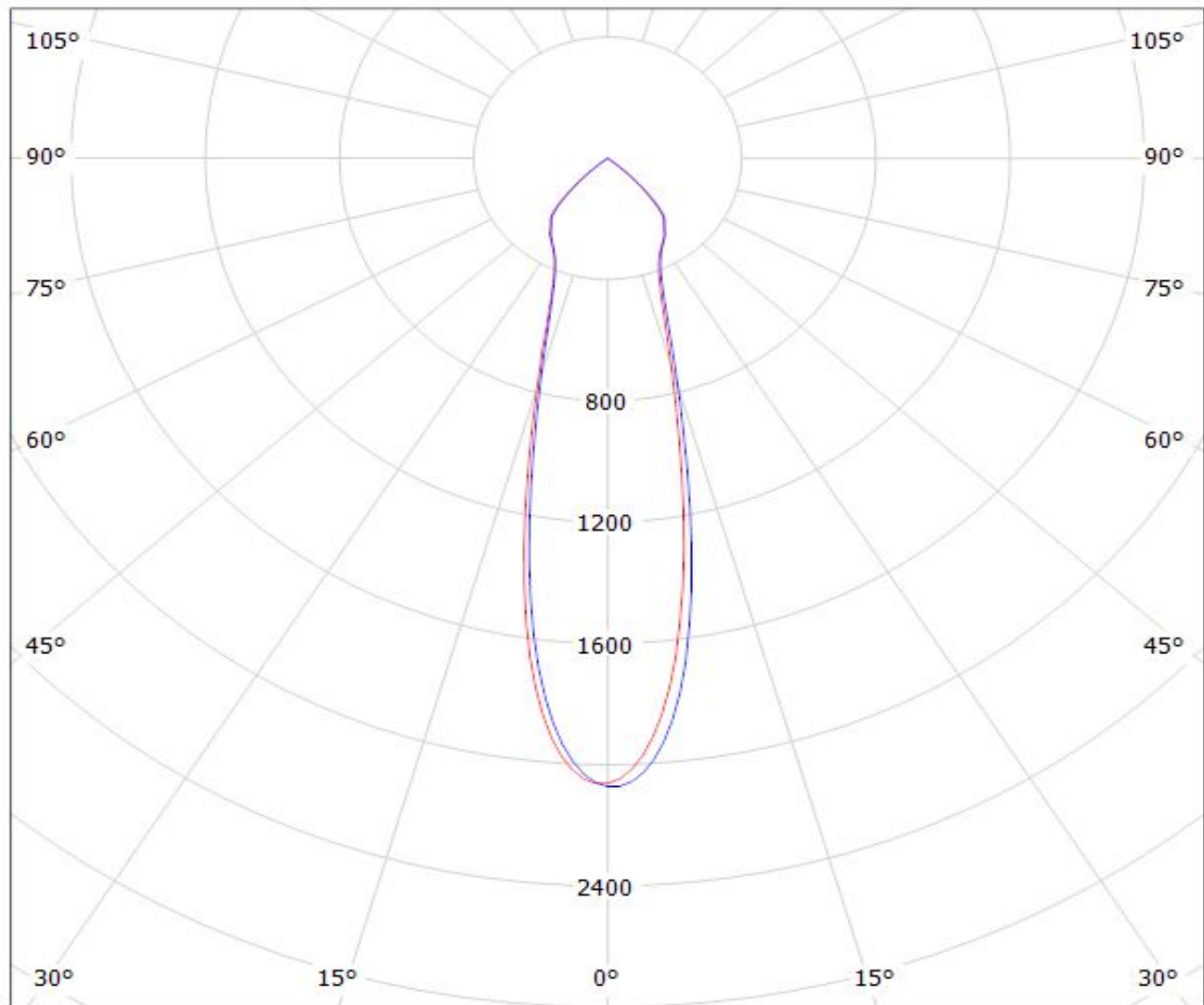

cd/klm

— C0 - C180

— C90 - C270

$\eta = 90\%$

Luminaire: LEDiL Oy F13325_ANGELINA-S_(STARK_SLE_G2_LES26) Eff.89.2%
Lamps: 1 x TRIDONIC STARK SLE G2 LES26 830 CLA 1095.88lm@250mA CCT=3000K P=8W I=250mA

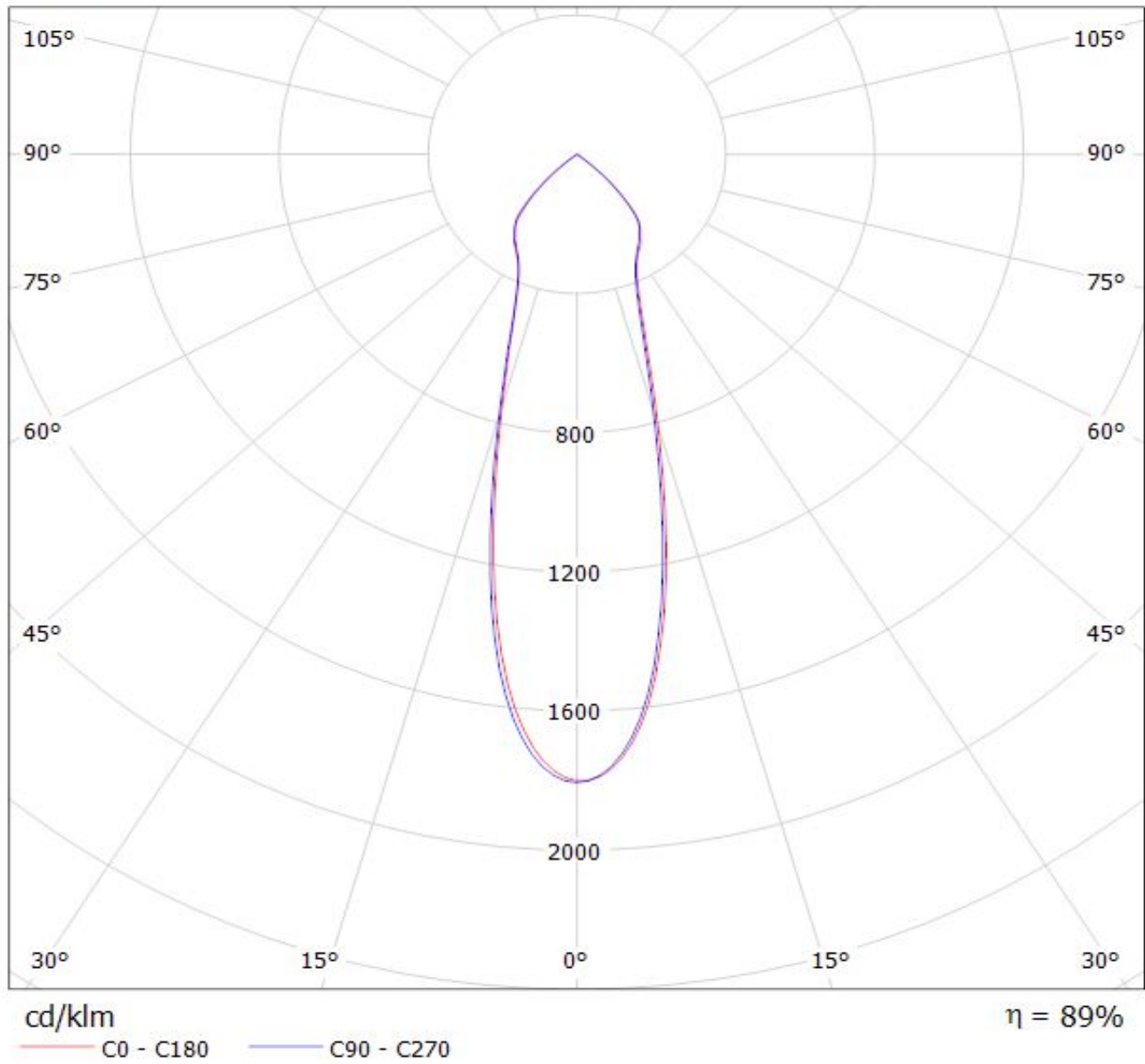

LEDiL Oy F13325_ANGELINA-S_(SLE_G3_LES19) Eff.93.5% / LDC (Polar)

Luminaire: LEDiL Oy F13325_ANGELINA-S_(SLE_G3_LES19) Eff.93.5%

Lamps: 1 x TRIDONIC_STARK_SLE_G3_LES19_(STARK-SLE-G3-LES19-2000-840-CLA)
_1058.33lm@250mA_P=8.32833W_I=249.8mA

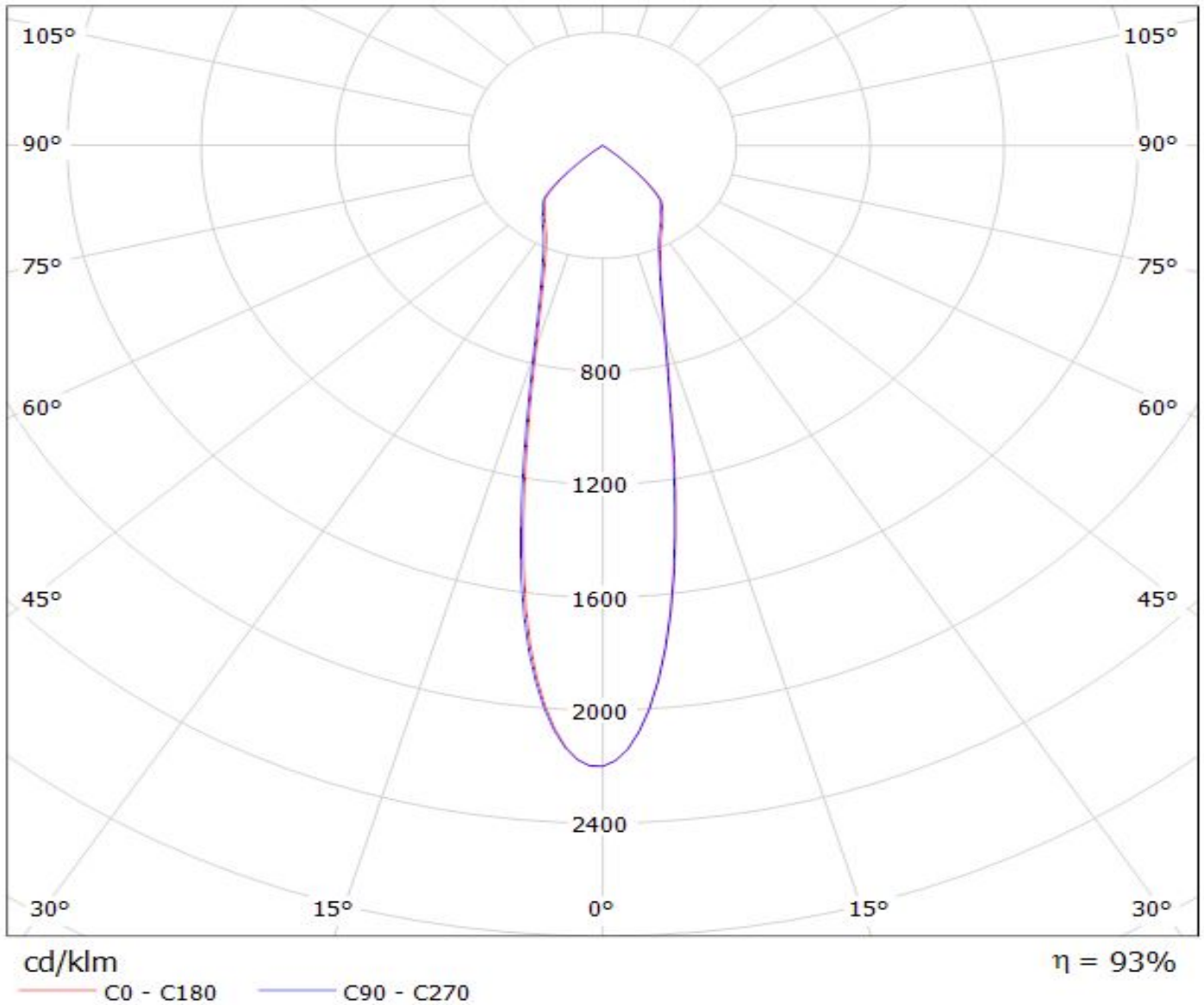

Luminaire: LEDiL Oy F13325_ANGELINA-S_(SLE_G3_LES23) Eff.91.2%

Lamps: 1 x TRIDONIC_STARK_SLE_G3_LES23_(STARK-SLE-PURE_G3-23-3000-930-SEL)_813.196lm@250mA_CCT=3000K_P=8.20018W_I=249.8mA

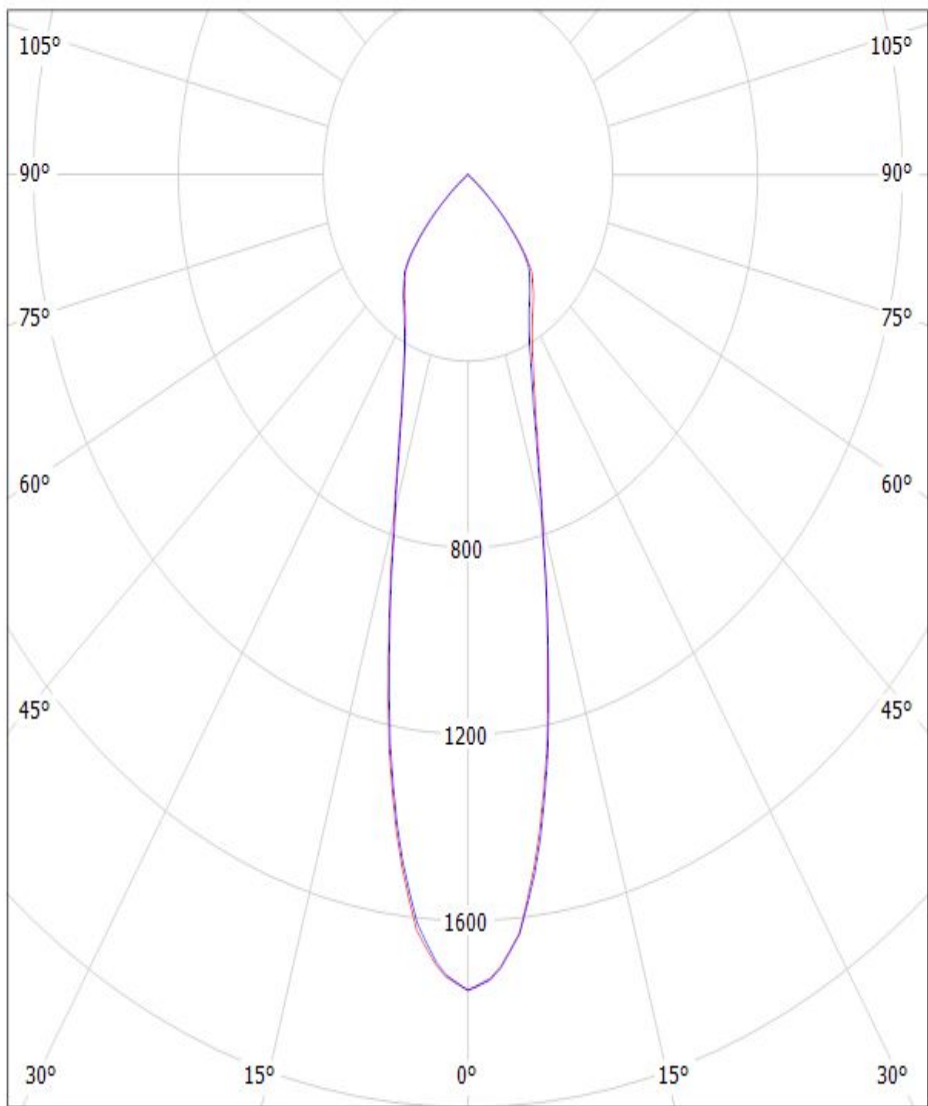

cd/klm

— C0 - C180 — C90 - C270

$\eta = 91\%$

Luminaire: LEDiL Oy F13325_ANGELINA-S_(SLE_G4_LES23)

Lamps: 1 x Tridonic_SLE_G4_LES23_1354.57lm@250mA_P=8.18744W_I=0.2498A

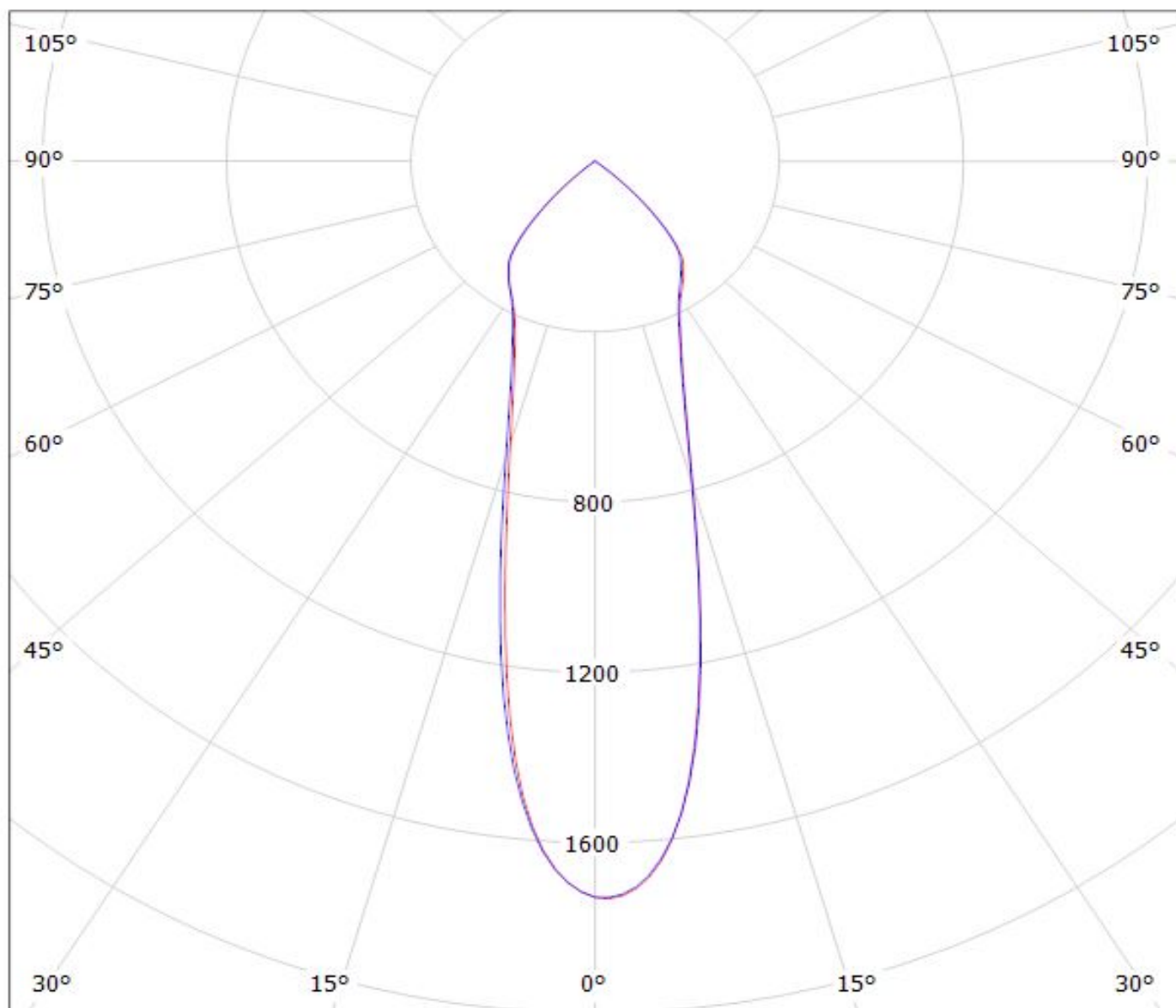

cd/klm

— C0 - C180

— C90 - C270

$\eta = 93\%$

Luminaire: LEDiL Oy F13325_ANGELINA-S_(SLE GEN4 LES19)
Lamps: 1 x SLE GEN4 LES19_1227.01lm@250mA_P=8.21492W_I=0.2498A

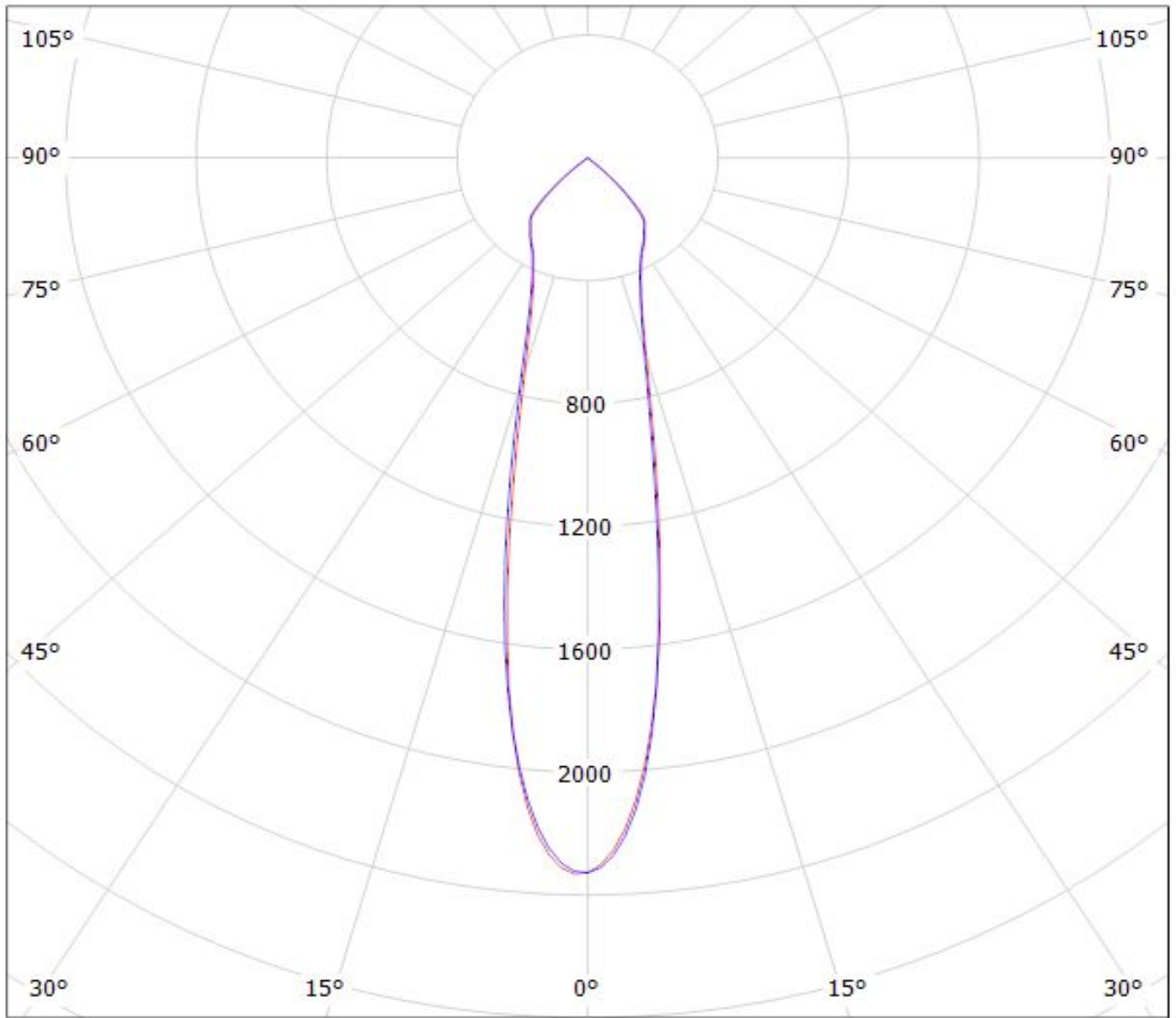

cd/klm

$\eta = 92\%$

— C0 - C180

— C90 - C270

Luminaire: LEDiL Oy F13325_ANGELINA-S_(SLE-G5_LES-15)

Lamps: 1 x Tridonic_SLE-G5_LES-15_1238lm@250mA_P=8.6575W_I=0.250A

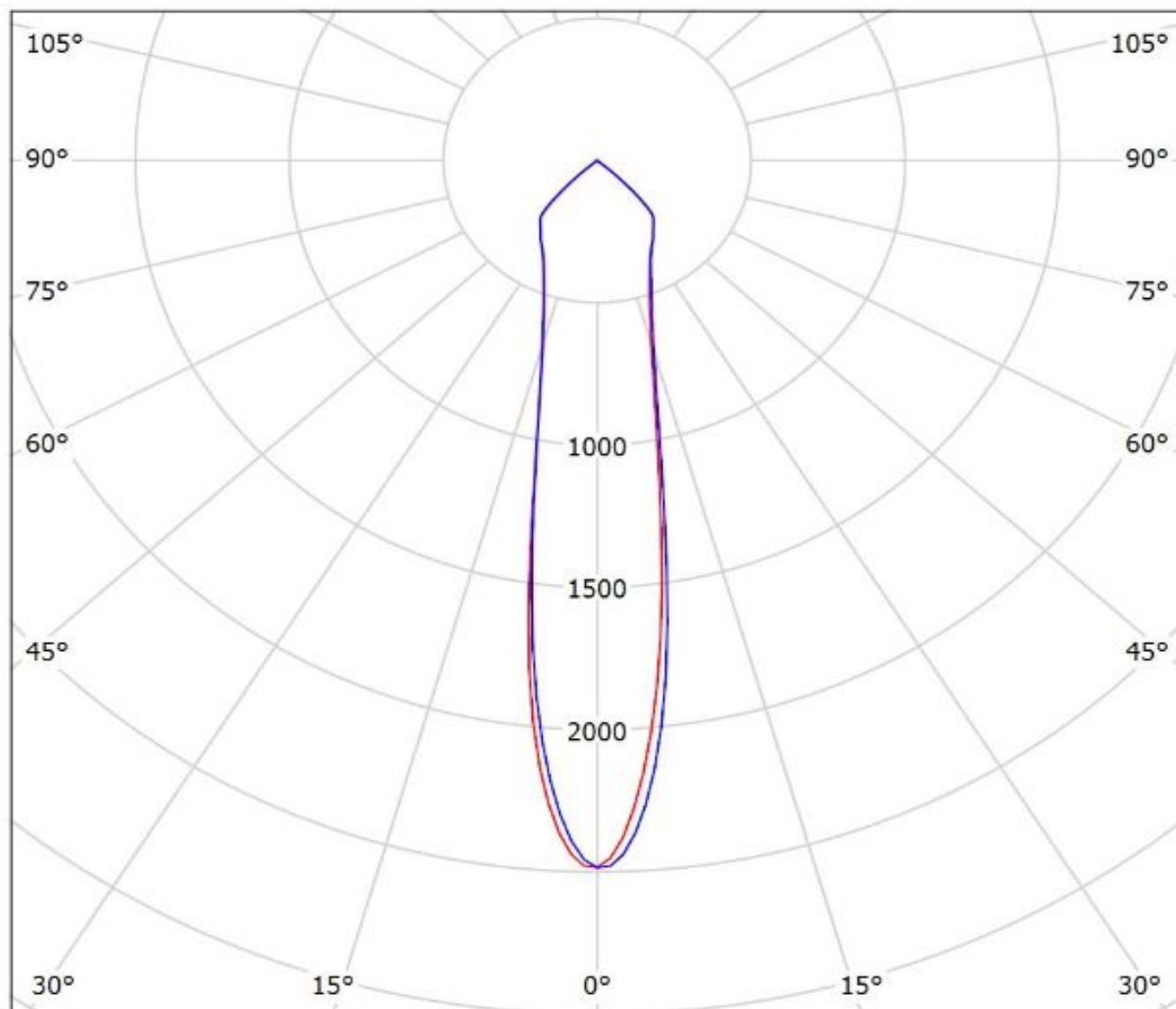

cd/klm

— C0 - C180

— C90 - C270

$\eta = 93\%$

Luminaire: LEDiL Oy F13325_ANGELINA-S_(SLE-G5_LES-19)

Lamps: 1 x Tridonic_SLE-G5_LES-19_1287.79lm@250mA_P=8.2274W_I=0.250A

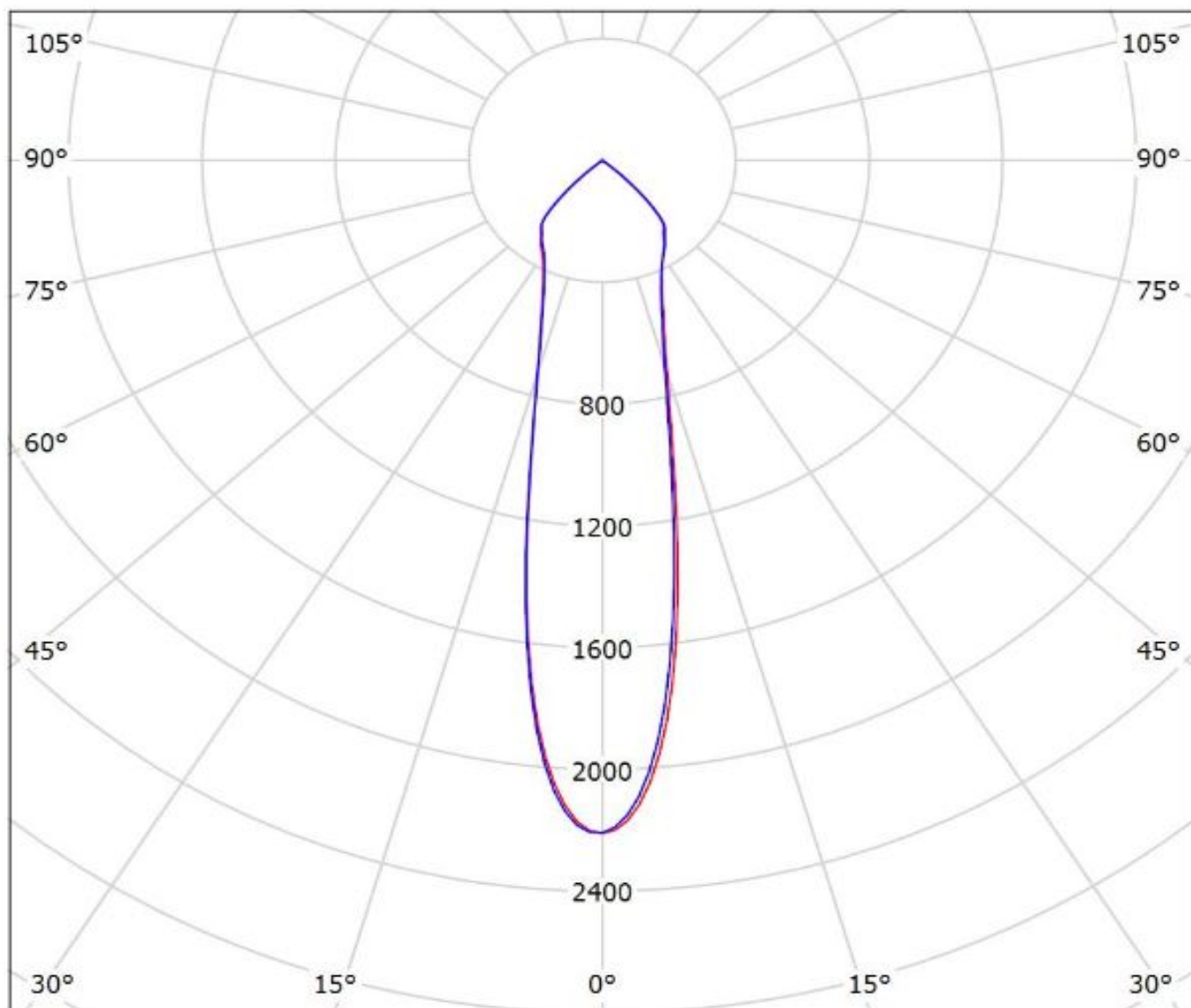

cd/klm

— C0 - C180 — C90 - C270

$\eta = 93\%$

Luminaire: LEDiL Oy F13325_ANGELINA-S_(SLE-G5_LES-23)

Lamps: 1 x Tridonic_SLE-G5_LES-23_1303.96lm@250mA_P=8.1062W_I=0.250A

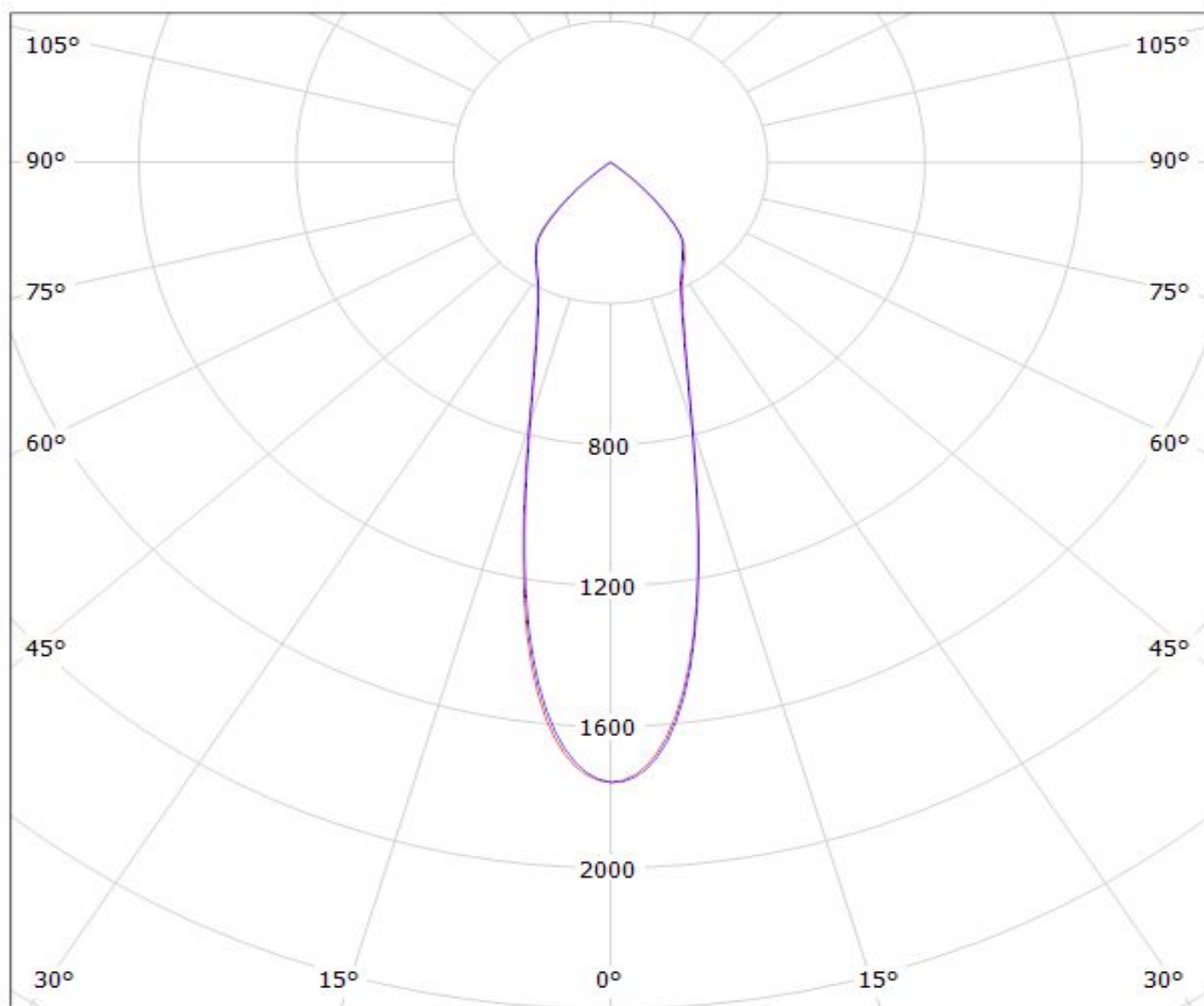

cd/klm

— C0 - C180

— C90 - C270

$\eta = 94\%$

Luminaire: LEDiL Oy F13325_ANGELINA-S_(WU-M-461-827)

Lamps: 1 x Vossloh_WU-M-461-827_771.829lm@250mA_P=6.26998W_I=249.8mA

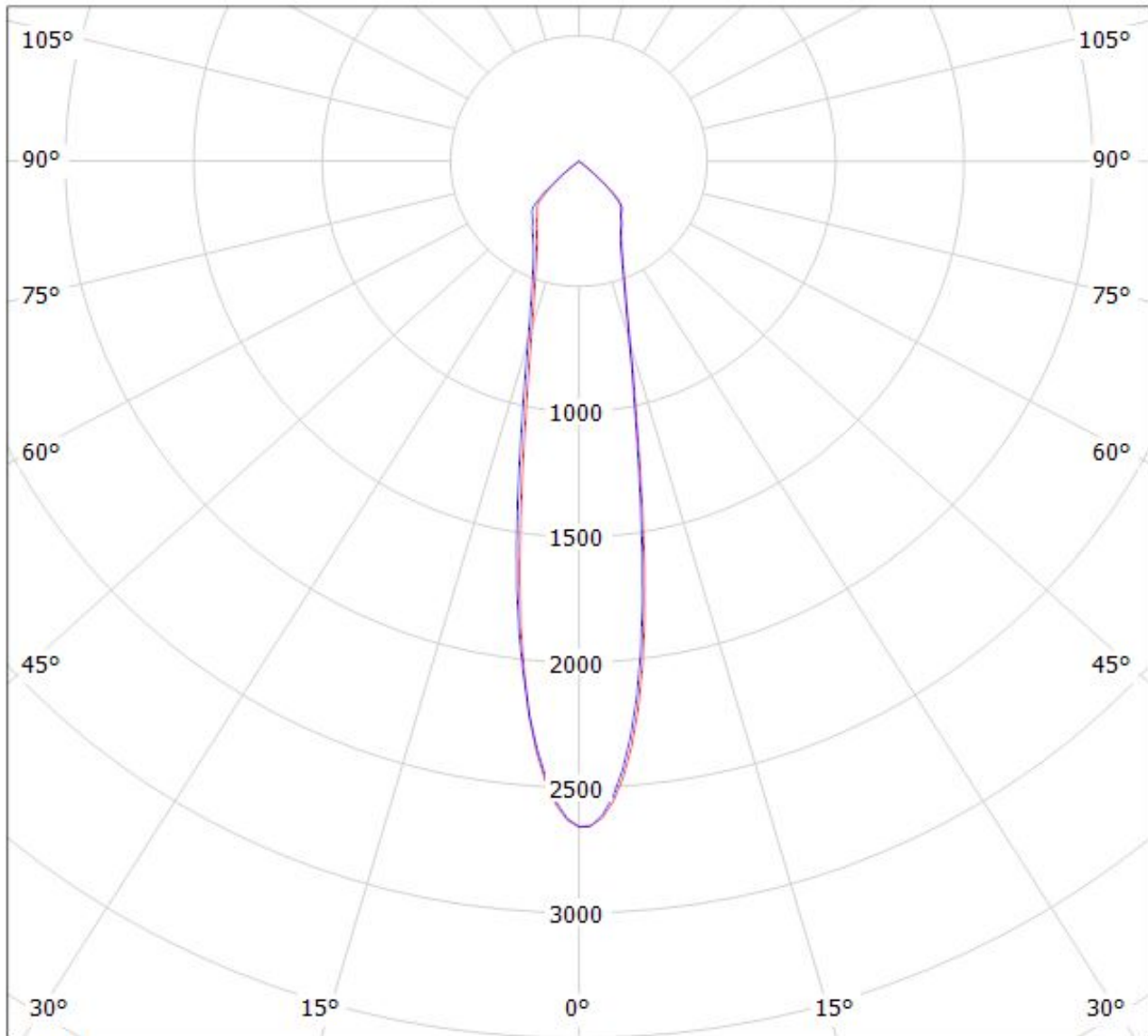

cd/klm

— C0 - C180

— C90 - C270

$\eta = 94\%$

Luminaire: LEDiL Oy F13325_ANGELINA-S_(WU-M-462-827)

Lamps: 1 x Vossloh_WU-M-462-827_1116.7lm@250mA_P=8.9943W_I=249.8mA

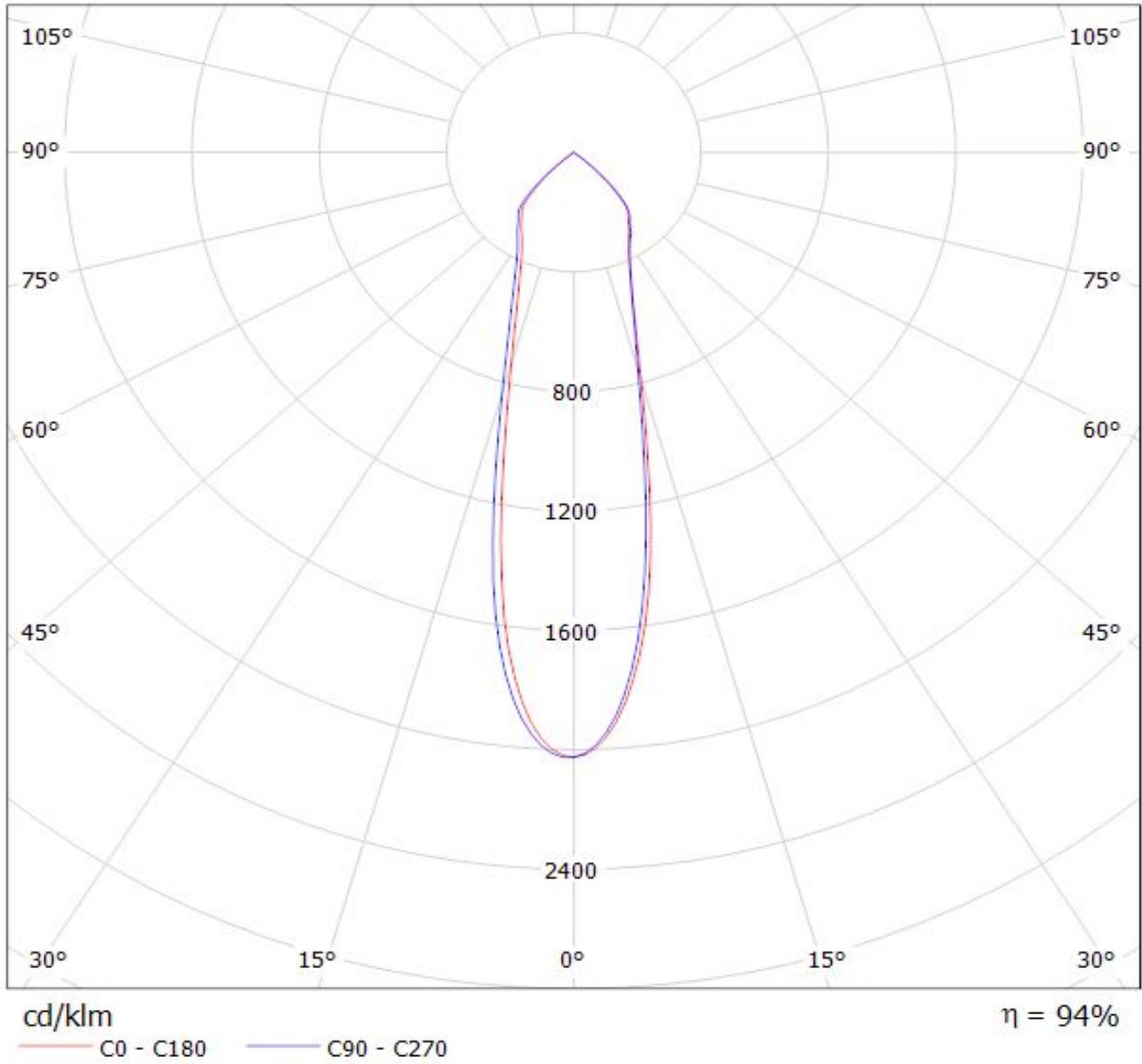

Luminaire: LEDiL Oy F13325_ANGELINA-S_(WU-M-464-827)

Lamps: 1 x Vossloh_WU-M-464-827_1452.93lm@250mA_P=11.6939W_I=249.8mA

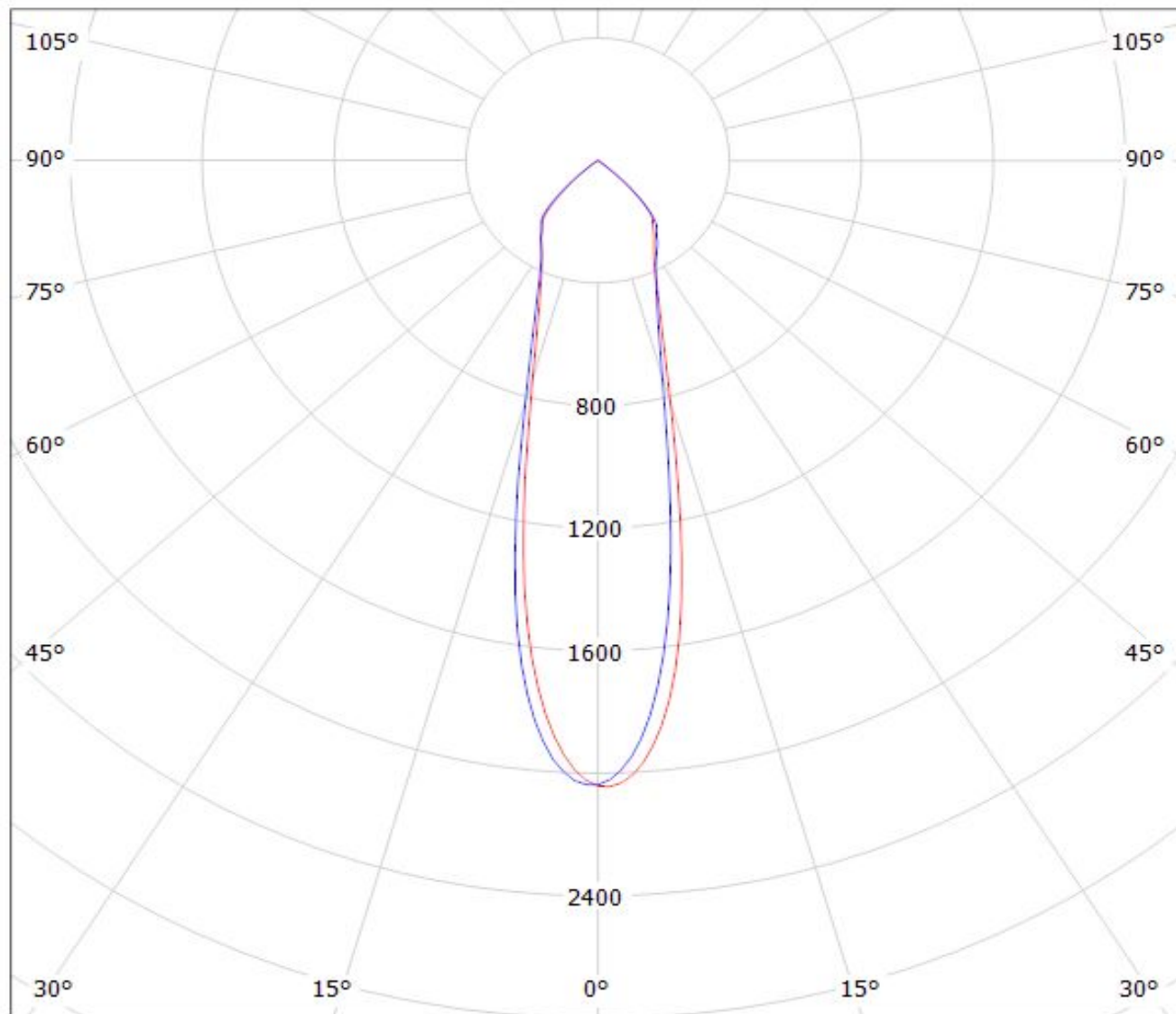

cd/klm

$\eta = 94\%$

— C0 - C180 — C90 - C270

Luminaire: LEDiL Oy F13325_ANGELINA-S_(WU-M-484)

Lamps: 1 x Vossloh_Schwabe-WU-M-484_(WU-M-484-830)_657.721lm@250mA_P=5.59451W_I=249.9mA

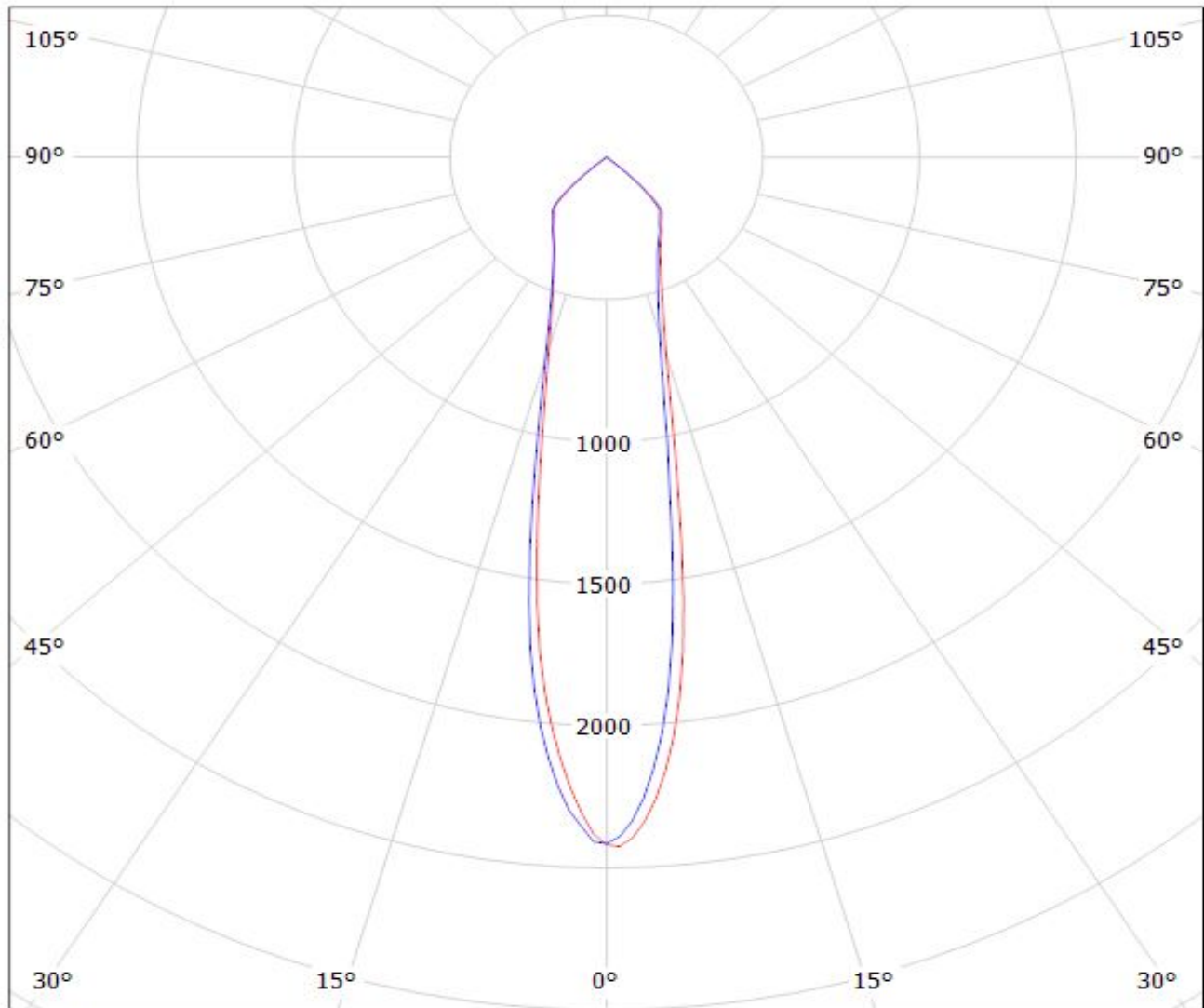

cd/klm

$\eta = 93\%$

— C0 - C180

— C90 - C270

Luminaire: LEDiL Oy F13325_ANGELINA-S_(WU-M-485)

Lamps: 1 x Vossloh_Schwabe-WU-M-485_(WU-M-485-830)_1209.62lm@250mA_P=8.43849W_I=249.8mA

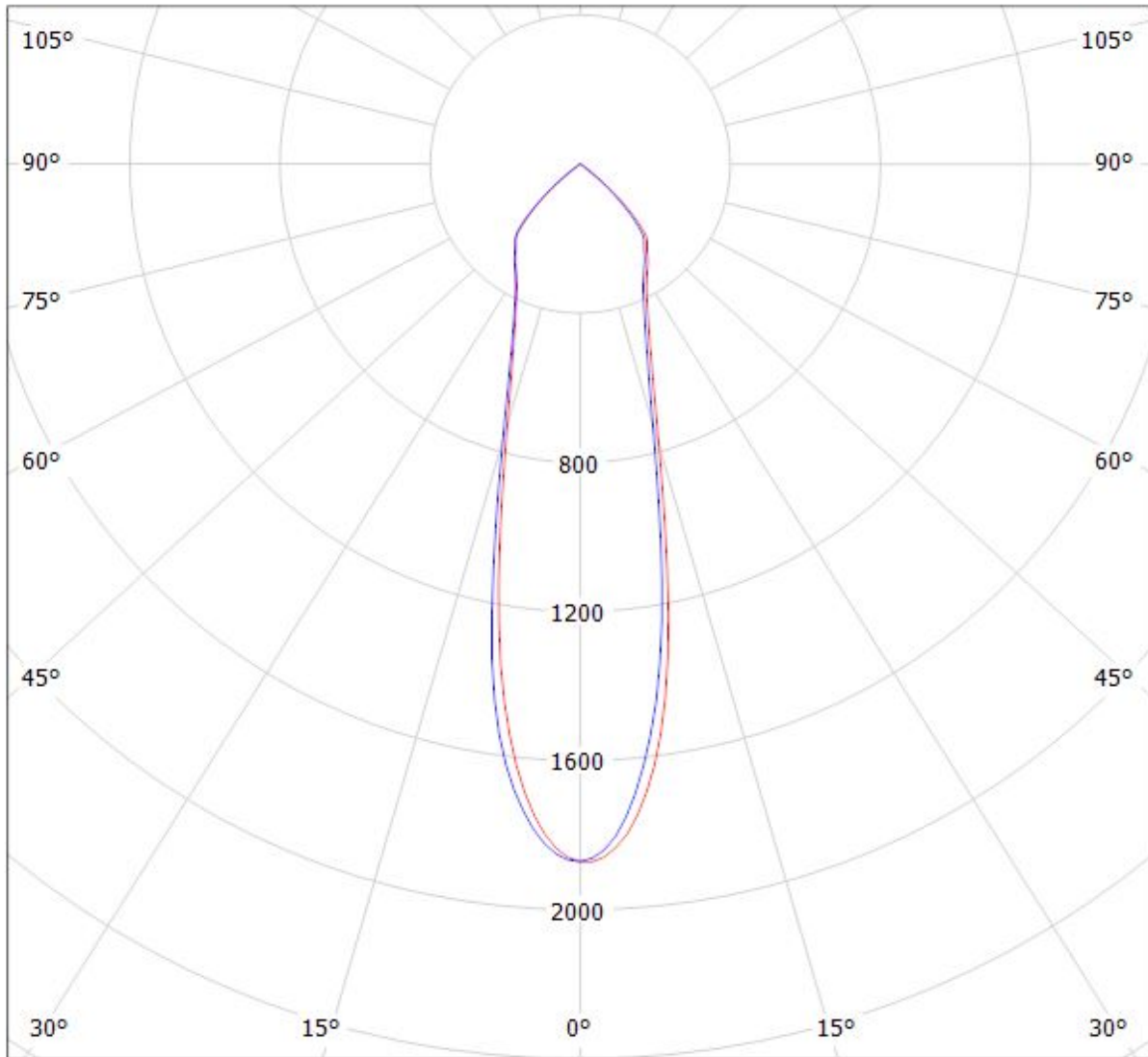

cd/klm

— C0 - C180

— C90 - C270

$\eta = 93\%$

Luminaire: LEDiL Oy F13325_ANGELINA-S_(WU-M-486) Eff.93.3%
Lamps: 1 x Vossloh_Schwabe-WU-M-486_(WU-M-486-830)
_1474.55lm@250mA_P=10.4456W_I=249.8mA

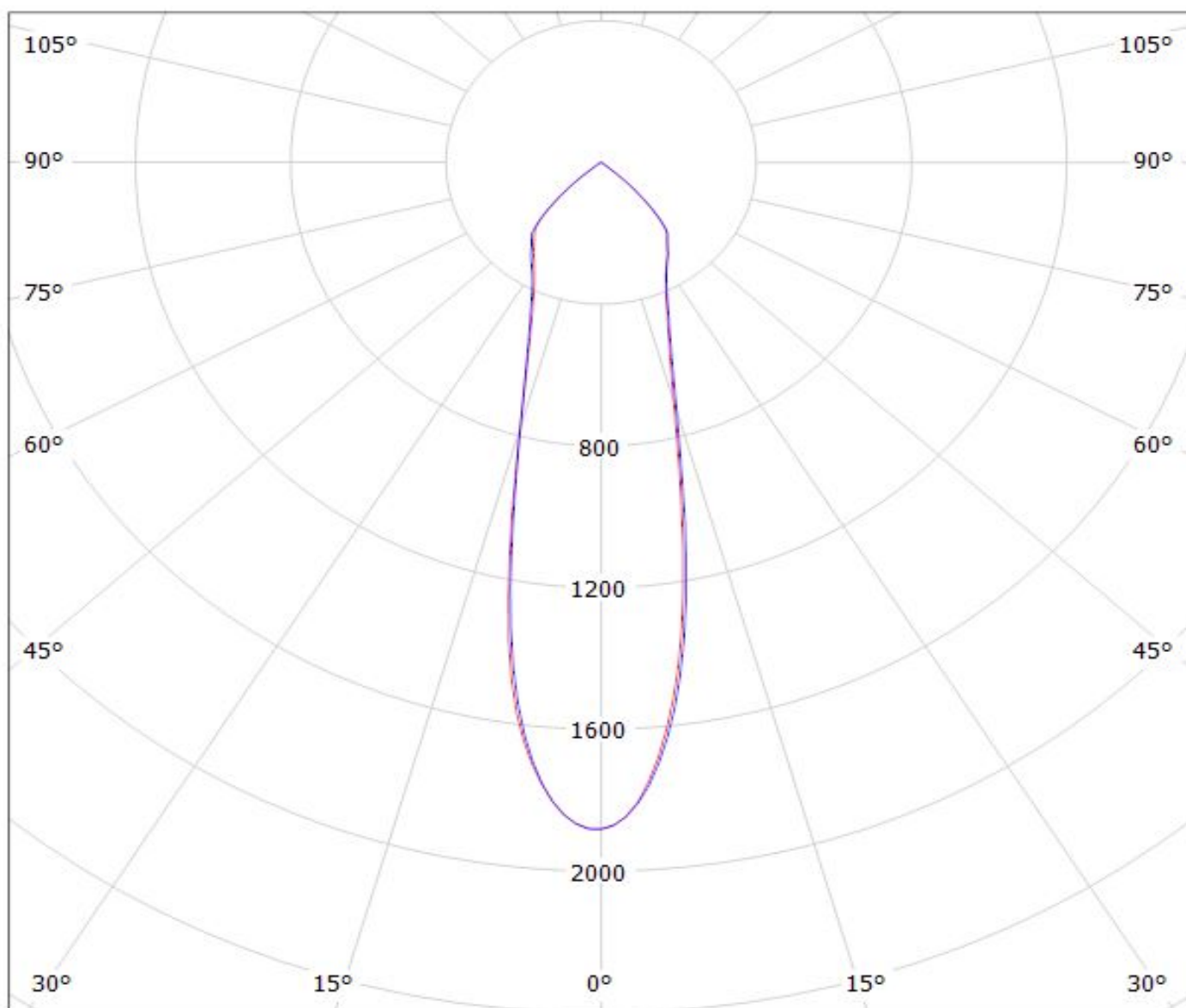

cd/klm

— C0 - C180

— C90 - C270

$\eta = 93\%$

NOTE: The typical divergence will be changed by different color, chip size and chip position tolerance. The typical total divergence is the full angle measured where the luminous intensity is half of the peak value.

GENERAL INFORMATION

- Product series especially designed & optimized for series of LEDs.
- Special care taken to make light distribution as uniform as possible.

Note! Due to use of high power COB's with this product, special attention to proper thermal design is highly recommended. LEDiL has no liability for direct, indirect or consecutive damages arising from the LEDiL products being used outside of the recommended temperature range.