

EA、EAX系列

EA、EAX Series

特点 Features

- 体积小，常规通用
Compact unit, general purpose
- 对三相平衡不平衡负载均有效
Effective for both balanced and unbalanced
three phase loads

应用 Applications

- 抑制沿电源线传输的工业无线电干扰
Suppress the industrial radio interference along power lines



技术参数 Technical Data

额定电压 Rated Voltage	250/440 VAC
工作频率 Operating Frequency	50/60Hz
额定电流 Rated Current	5A~600A
耐压试验 (一分钟) Test Voltage (1min)	1500 VDC (line/line) 2250 VDC (line/ground)
气候类别 Climatic Category	25/085/21

型号 Model	端子方式 Terminal		额定电流 Rated Current (A)	接地电容量 Ground Capacitance (nF)	放电电阻 Discharge Resistance (MΩ)	电路图 Circuit Diagram fig.	外形尺寸 Dimension fig.
	入 Input	出 Output					
DL-5EA			5	6.8		1	1
DL-10EA			10	6.8		1	1
DL-5EAX1			5	6.8		1	2
DL-10EAX1			10	6.8		1	2
DL-15EA3			15	6.8		2	5
DL-20EA3			20	6.8		2	5
DL-25EA3			25	6.8		2	5
DL-30EA3			30	6.8		2	5
DL-40EA3			40	10	1	2	6
DL-50EA3			50	10	1	2	6
DL-80EA1			80	10	0.68	2	3
DL-100EA1			100	13.6	0.44	2	4
DL-150EA1			150	200	0.44	2	3
DL-200EA5			200	200	0.68	3	3
DL-300EA5/60			300	690	0.68	4	7
DL-600EA5/60			600	690	0.68	4	8



电原理图 Typical Circuit Diagram

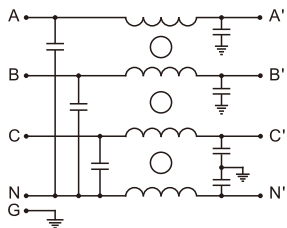

fig.1

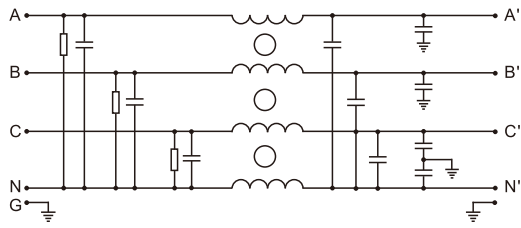

fig.2

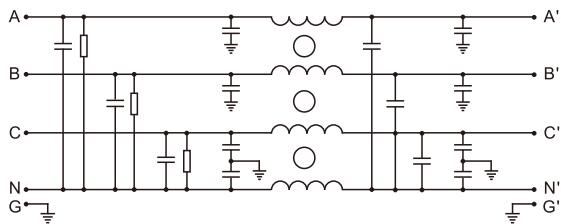

fig.3

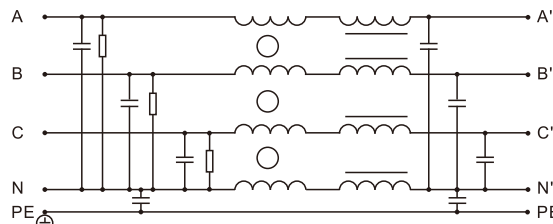

fig.4

外形尺寸 Outline Drawing and Dimensions (mm)

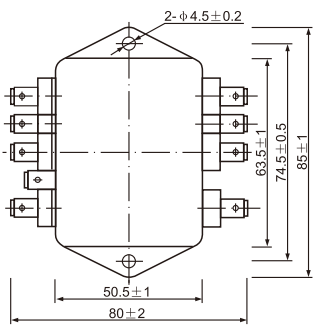

fig.1

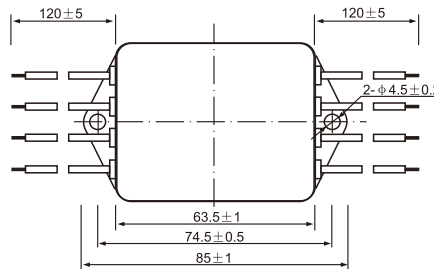
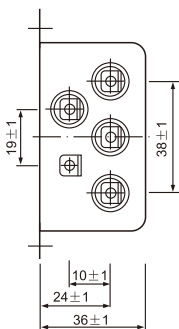

fig.2

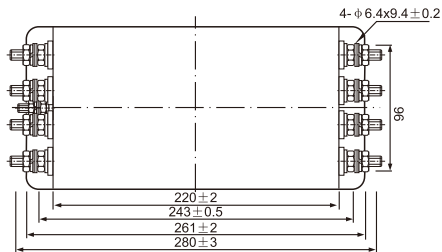
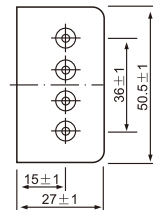

fig.3

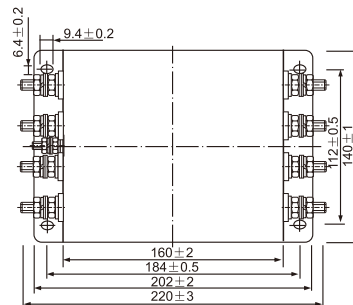
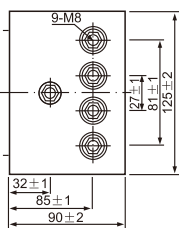

fig.4

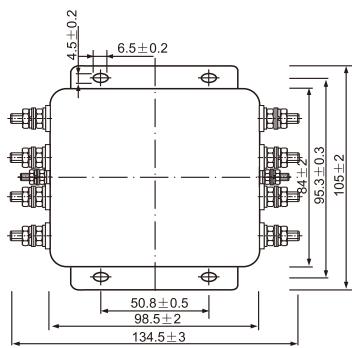
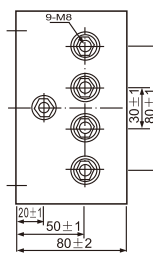

fig.5

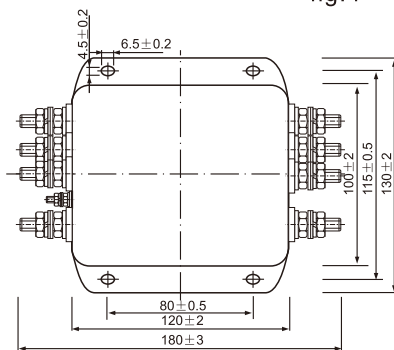
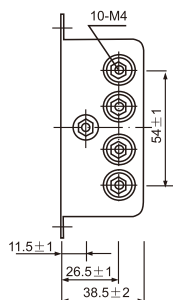
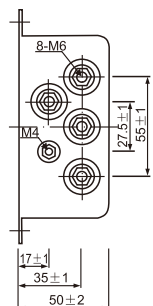

fig.6



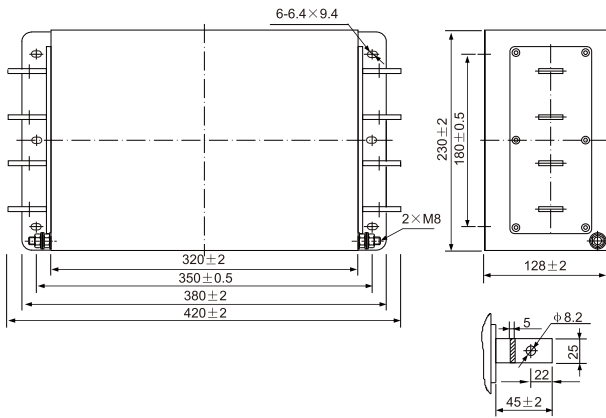

fig.7

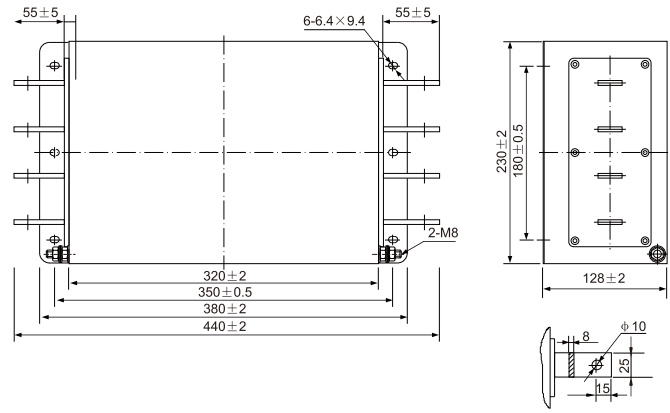
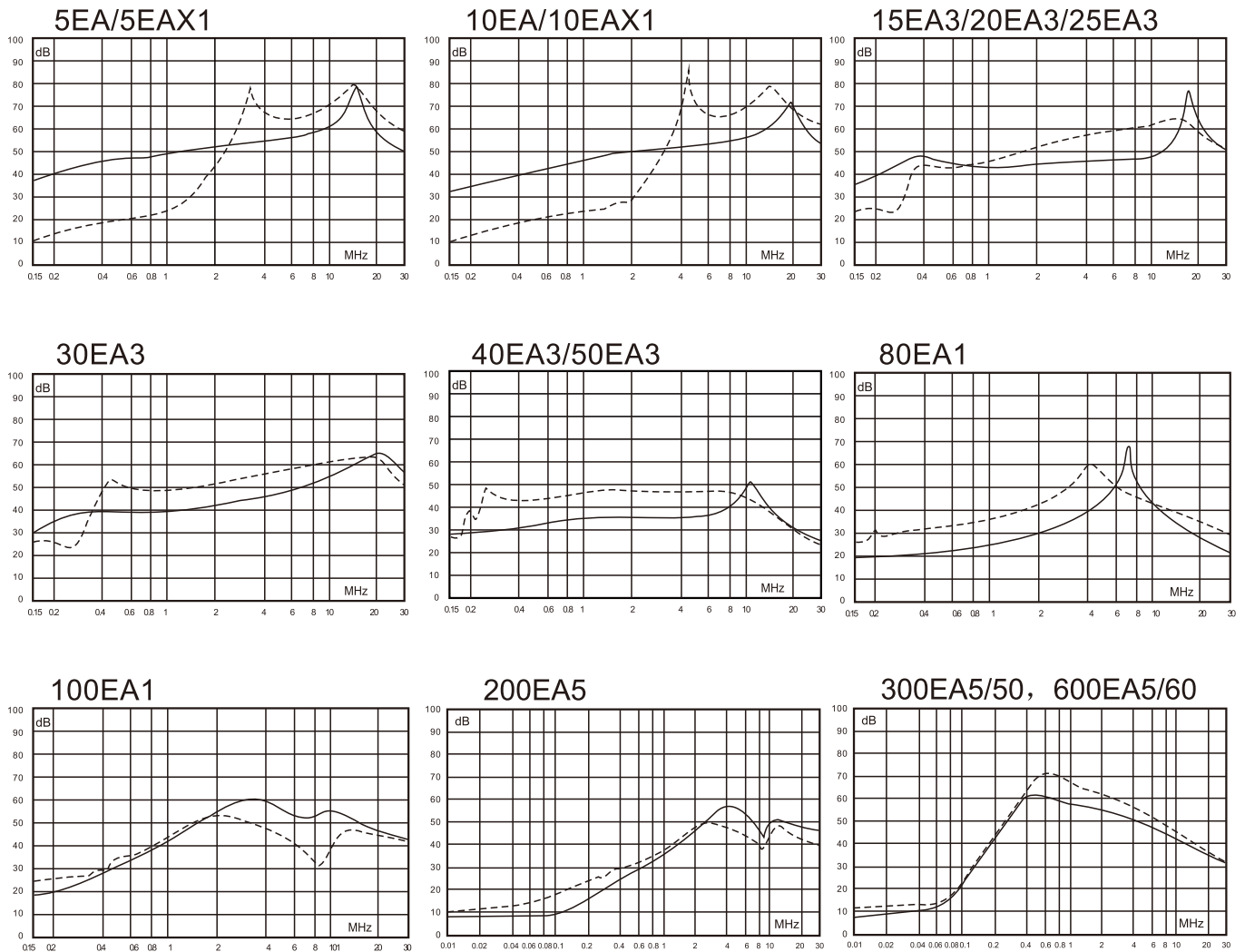

fig.8

插入损耗 Insertion Loss in dB

(50 Ω 测量系统, IEC/CISPR No.17 号出版物 Measured in 50 Ω system, as IEC/CISPR No.17)



—— 共模(Common Mode)
 - - - - 差模(Differential Mode)