



interface
Solutions for the Control Cabinet

Catalog 2017





▲ Plant II, Rodezstraße in Bamberg



▲ Company headquarters in Bamberg



▲ STOCKO main plant in Wuppertal

wieland group

AT HOME ALL OVER THE WORLD

Wieland Electric GmbH is a medium-sized family-run electrical and electronics company headquartered in Bamberg. Founded in 1910, Wieland is one of the pioneers of electrical connection technology.

This family business with its international outlook is a market leader in pluggable installation technology for functional buildings, with subsidiaries worldwide and production lines not only in Bamberg but also in the Czech Republic and China.

The Wieland Group, which has included STOCKO Contact GmbH & Co. KG since 1998, is therefore represented in over 70 countries and employs some 2,200 people.



Solutions for

Building technology

Wind power

Machine building

Lighting technology

Heating, ventilation, air conditioning



Product portfolio

- Electronic and electrical engineering for the control cabinet
- Safety technology
- Network and field bus systems
- Energy bus systems for industry and buildings
- Connectors up to protection type IP6X
- Building automation
- PCB terminals and plug connectors
- Sensor/actuator cabling



Industries

- Machine building
- Construction machines & cranes
- Buildings and lighting
- Logistics
- Power engineering
- Renewable energy sources
- Heating, ventilation and air conditioning systems



Business services

- Pre-assembly and wiring
- Product labeling service
- Integrated solutions inside distributors
- Customized solutions
- On-site project support
- Optimization of decentralized, pluggable installation solutions
- Certified machine safety tests



Safety training

- Software validation
- CSE certified safety engineers
- Basics and standards of functional safety
- Modification of old machines and major changes
- Design of safety functions and calculation with Sistema
- Machinery Directive, liability issues and CE conformity explanations



Software/configuration tools

- **wieplan** CLICK2BUY, configuration of terminal strips including online order
- **wieprint**, marking system for DIN rail terminal blocks
- **revos** configurator for connectors
- **gesis**[®]PLAN for building installation
- **podis**[®]PLAN for configuring the **podis**[®] energy bus system
- **samos**[®]PLAN 6, programming tool for **samos**[®]PRO COMPACT











Why Wieland?

- Standardized industrial solutions
- Customized solutions
- Support for your project
- Broad product portfolio
- Application worldwide due to international licenses
- Group-wide observance of human rights, including at suppliers
- Eco-friendly production





Contents

The Wieland Group	2	
interface Signal processing throughout your control system with our connectivity solutions	6	
Networking wienet Network switches, WLAN access points and VPN routers in the age of Industry 4.0	10	
Supply wipos power supplies Pure Power – no frills	36	
Coupling flare / cores Always the right connection	46	
Control ricos FLEX I/O fieldbus modules flare TIME timer and switching relays Modular and compact control and connection	60	
Measure and monitor flare CONTROL measuring and monitoring relays The right device for every monitoring task	76	
Protect wietap overvoltage protection	82	
Index	110	
Additional catalogs	112	
Support and consultation	114	
Subsidiaries and sales representatives	115	

contacts
are
green.





interface

Signal processing

throughout your **control system**,
with our **connectivity solutions**

Versatility for every application

Wherever current flows and signals are processed, the unique strengths of Wieland Electric **interface** products shine through. Thanks to a broad range of relays, power supplies and overvoltage protection devices, as well as **interface** and analog modules, your application will also become a real all-rounder. Send all the right signals with our interface technology and innovative DIN rail terminal blocks.



Applications:

- Machine building
- Process control
- Transportation & material handling
- Automotive industry
- Power distribution
- Petrochemical
- Food industry
- Manufacturing engineering



Signal processing throughout your control system with



| networking |

wienet Network switches, WLAN access points and VPN routers in the age of Industry 4.0



| supply |

wipos power supplies including single-phase and three-phase devices for DIN rail mounting in almost any application



| coupling |

flare relays for floating coupling of control functions. Analog isolation amplifier **cores** for secure coupling.

our

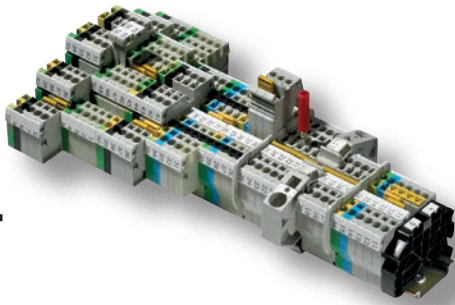

connectivity solutions



| control |

ricos FLEX, the modular and compact I/O fieldbus system, which can be combined and used very flexible. Timer and multi-function relays **flare** TIME for simple to highly complex control tasks



| protection |

wietap overvoltage protection devices for guaranteed highest system availability and device protection



| measuring and monitoring |

Electronic measuring and monitoring relays **flare** CONTROL for all monitoring and communicating tasks in machines and systems



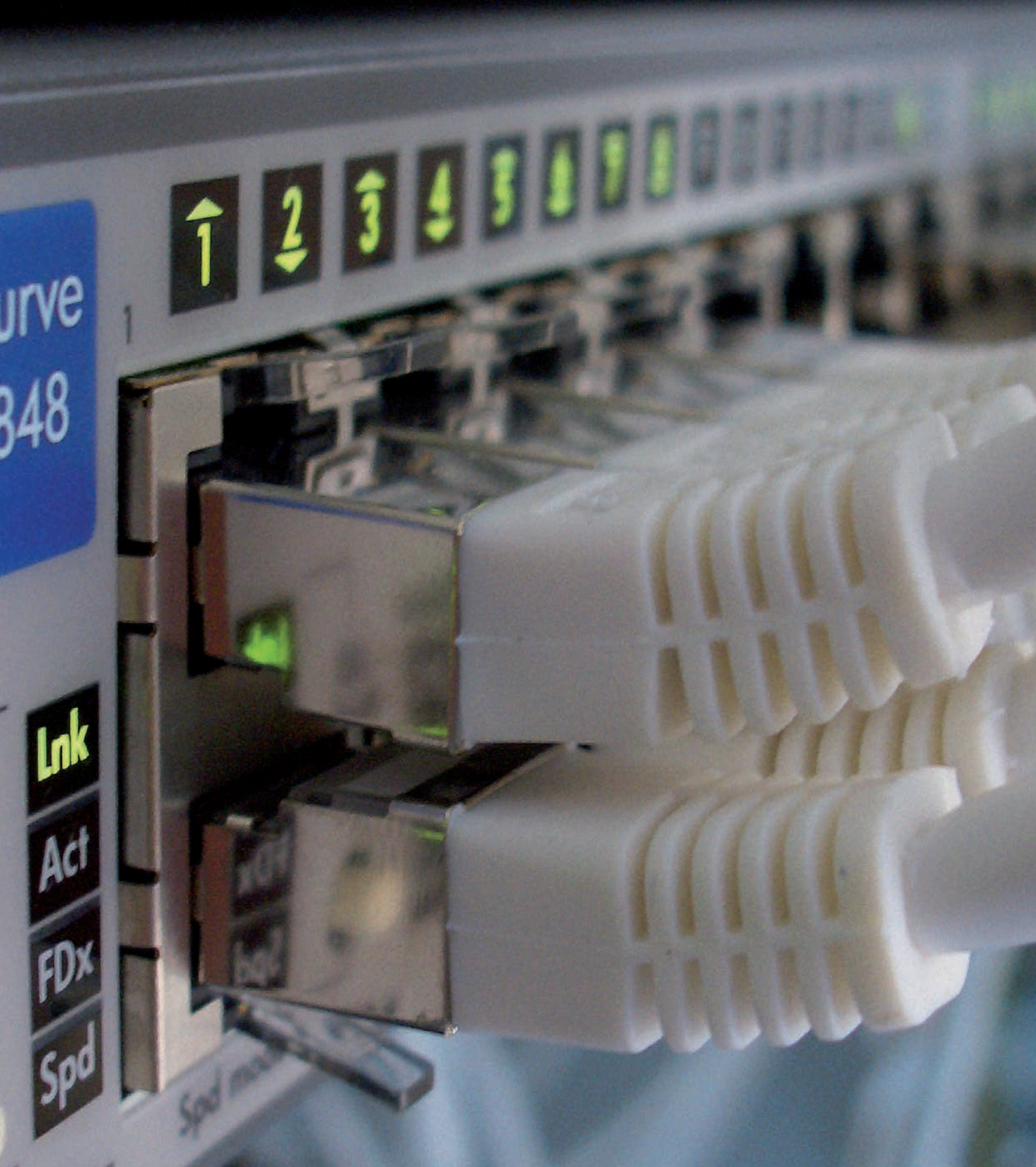

Industrial Ethernet switches

Safe and fast communication
for your process.

Ethernet connections have become part of many areas of life. This global standard is also making inroads into automation technology. Ethernet switches have become quite common for safe networking and coupling between machines, or inside the system. They manage the data flow in an effective and target-oriented manner. The devices are designed to be very robust and are optimally suited to harsh industrial environments.

Benefits:

- Redundant power supply
- Full compatibility according to IEEE 802.3, including autocrossing, autonegotiation, autosensing, auto-polarity
- Complete diagnostics display via various LEDs
- Compact design
- DIN rail mounting or screw connection
- Robust designs
- High degree of protection (IP30)
- PoE variants
- Light Managed variants (QoS, Jumbo Frame)



Unmanaged Ethernet Switches (Fast Ethernet)

wienet UMS 5-W

- Slim 5-port Fast Ethernet switch
- Redundant 24 V/48 V DC voltage supply
- With signal relay
- Extensive operating temperature range from -40 °C to 75 °C



Type	Part No.
wienet UMS 5-W	83.040.1001.0
Technical data	
Ethernet	
Number of ports	5 x 10/100Base-T(X)
Ethernet transfer rates	10/100 Mbps
Store and forward switching mode	Yes
Autocrossing	Yes
Autonegotiation	Yes
Autosensing	Yes
Autopolarity	Yes
Full IEEE 802.3 compatibility	Yes
Topology	Line, star, mesh
Power supply	
Operating voltage	12...48 V DC
Redundant power supply	2 power inputs P1, P2
Diagnostic LEDs	P1, P2, P-Fail, 10/100T(X): Link/Activity, Duplex/Collision
Power requirement	4.5 W max.
Ambient conditions	
Operating temperature	-40 °C ... +75 °C
Storage temperature	-40 °C ... +85 °C
Rel. air humidity during operation	10 ... 95% (non-condensing)
Other technical data	
Dimensions (mm) W x H x D	30 x 120 x 95
Housing	Metal
Mounting	Top-hat rail, wall (mounting set)
Weight	approx. 255 g
IP rating	IP30
Approvals	
	FCC Part 15 Subpart B Class A
	EN 55022 Class A, UL/cUL 60950
	EN 61000-4-2, EN 61000-4-3, EN 61000-4-4, EN 61000-4-5, EN 61000-4-6, EN 61000-4-8
	IEC 60068-2-27, IEC 60068-2-32, IEC 60068-2-6

wienet UMS 6



Type	Part No.
wienet UMS 6	83.040.0000.0
Technical Data	
Number of ports	6 RJ45 ports
Port types	6 x Ethernet and Fast Ethernet (10/100 Mbit/s)
Store and forward switching mode	yes
Autocrossing	yes
Autonegotiation	yes
Autosensing	yes
Autopolarity	yes
Full IEEE 802.3 compatibility	yes
Line, star and network topologies are possible	yes
Operating voltage	9 ... 30 V DC
Redundant power supply	2 infeeds
Diagnostic LEDs (power / link status / data / data rate)	yes / yes / yes / yes
Operating temperature	0 ... +60 °C
Dimensions (mm) W x H x D	45.3 x 90 x 90.5
Housing	Aluminum extrusion
Mounting	DIN rail and screw mounting
Type of connectors	Screw terminal, pluggable
Connector size	up to 1.5 mm ² (AWG 16)
Weight	250 g
Degree of protection	IP 40
Approvals	CE, FCC

Ethernet Switches (Fast Ethernet)

wienet UMS 6-L



Type	Part No.
wienet UMS 6-L	83.040.0000.1
Technical Data	
Number of ports	6 RJ45 ports
Port types	6 x Ethernet and Fast Ethernet (10/100 Mbit/s)
Store and forward switching mode	yes
Autocrossing	yes
Autonegotiation	yes
Autosensing	yes
Autopolarity	yes
Full IEEE 802.3 compatibility	yes
Line, star and network topologies are possible	yes
Operating voltage	9 ... 30 V DC
Redundant power supply	2 infeeds
Diagnostic LEDs (power / link status / data / data rate)	yes / yes / yes / yes
Operating temperature	0 ... +60 °C
Dimensions (mm) W x H x D	45 x 90 x 80
Housing	Thermoset
Mounting	DIN rail and screw mounting
Type of connectors	Screw terminal, pluggable
Connector size	up to 1.5 mm ² (AWG 16)
Weight	160 g
Degree of protection	IP 40
Approvals	CE FCC



wienet UMS 8



Type	Part No.
wienet UMS 8	83.040.0001.0
Technical Data	
Number of ports	8 RJ45-Ports
Port types	8 x Ethernet and Fast-Ethernet (10/100 Mbit/s)
Store and forward switching mode	yes
Autocrossing	yes
Autonegotiation	yes
Autosensing	yes
Autopolarity	yes
Full IEEE 802.3 compatibility	yes
Line, star and network topologies are possible	yes
Operating voltage	9 ... 30 V DC
Redundant power supply	2 infeeds
Diagnostic LEDs (power / link status / data / data rate)	yes / yes / yes / yes
Operating temperature	-10 ... +70 °C
Dimensions (mm) W x H x D	45.3 x 90 x 90.5
Housing	Aluminum extrusion
Mounting	DIN rail and screw mounting
Type of connectors	Screw terminal, pluggable
Connector size	up to 1.5 mm ² (AWG 16)
Weight	270 g
Degree of protection	IP 40
Approvals	CE FCC



Ethernet Switches (Giga Ethernet)

wienet UMS 8-G



Type	Part No.
wienet UMS 8-G	83.040.0106.0
Technical Data	
Number of ports	8 x RJ45
Port types	8 x Giga-Ethernet (10/100/1000 Mbit/s)
Store and forward switching mode	yes
Autocrossing	yes
Autonegotiation	yes
Autosensing	yes
Autopolarity	yes
Full IEEE 802.3 compatibility	yes
Line, star and network topologies are possible	yes
Operating voltage	9 ... 48 V DC
Redundant power supply	2 infeeds
Diagnostic LEDs (power / link status / data / data rate)	yes / yes / yes / yes
Operating temperature	-10 ... +70 °C
Dimensions (mm) W x H x D	45.3 x 90 x 90.5
Housing	Metal
Mounting	DIN rail and screw mounting
Type of connectors	Screw terminal, pluggable
Connector size	0.2 – 1.5 mm ² (AWG 24–16)
Weight	255 g
Degree of protection	IP 50
Approvals	CE FCC

wienet UMS 8-2G



Type	Part No.
wienet UMS 8-2G	83.040.0103.0
Technical Data	
Number of ports	10 RJ45-Ports
Port types	8 x Ethernet and Fast-Ethernet (10/100 Mbit/s) 2 x Giga-Ethernet (10/100/1000 Mbit/s)
Store and forward switching mode	yes
Autocrossing	yes
Autonegotiation	yes
Autosensing	yes
Autopolarity	yes
Full IEEE 802.3 compatibility	yes
Line, star and network topologies are possible	yes
Operating voltage	12 ... 48 V DC
Redundant power supply	2 infeeds
Diagnostic LEDs (power / link status / data / data rate)	yes / yes / yes / yes
Operating temperature	-40 ... +70 °C
Dimensions (mm) W x H x D	54 x 146 x 130.5
Housing	Aluminum extrusion
Mounting	DIN rail and screw mounting
Type of connectors	Screw terminal, pluggable
Connector size	up to 1.5 mm ² (AWG 16)
Weight	1000 g
Degree of protection	IP 40
Approvals	CE FCC

Ethernet Switches (with optical ports)

wienet UMS 4-1FM



Type	Part No.
wienet UMS 4-1FM	83.040.0002.0
Technical Data	
Number of ports	4 x RJ45, 1 x ST (optical multi mode)
Port types	10/100BaseT(X), 100BaseFX
Max. distance	2 km
Store and forward switching mode	yes
Autocrossing	yes
Autonegotiation	yes
Autosensing	yes
Autopolarity	yes
Full IEEE 802.3 compatibility	yes
Line, star and network topologies are possible	yes
Operating voltage	9 ... 30 V DC
Redundant power supply	2 infeeds
Diagnostic LEDs (power / link status / data / data rate)	yes / yes / yes / yes
Operating temperature	-10 ... +70 °C
Dimensions (mm) W x H x D	45.3 x 90 x 90.5
Housing	Metal
Mounting	DIN rail and screw mounting
Type of connectors	Screw terminal, pluggable
Connector size	0.2 – 1.5 mm ² (AWG 24–16)
Weight	260 g
Degree of protection	IP 50
Approvals	CE  FCC



wienet UMS 4-1FS



Type	Part No.
wienet UMS 4-1FS	83.040.0003.0
Technical Data	
Number of ports	4 x RJ45, 1 x SC (optical single mode)
Port types	10/100BaseT(X), 100BaseFX
Max. distance	2 km
Store and forward switching mode	yes
Autocrossing	yes
Autonegotiation	yes
Autosensing	yes
Autopolarity	yes
Full IEEE 802.3 compatibility	yes
Line, star and network topologies are possible	yes
Operating voltage	9 ... 30 V DC
Redundant power supply	2 infeeds
Diagnostic LEDs (power / link status / data / data rate)	yes / yes / yes / yes
Operating temperature	-10 ... +70 °C
Dimensions (mm) W x H x D	45.3 x 90 x 90.5
Housing	Metal
Mounting	DIN rail and screw mounting
Type of connectors	Screw terminal, pluggable
Connector size	0.2 – 1.5 mm ² (AWG 24–16)
Weight	260 g
Degree of protection	IP 50
Approvals	CE  FCC



Power over Ethernet (PoE)

The **wienet** Power over Ethernet switches enable the joint transfer of energy and data as per IEEE 802.3 on one Ethernet line. Up to 15.4 W can be supplied per PoE port.

Benefits:

- Save additional power supply units and the related installation costs
- Mount cameras, IP telephones or WLAN access points with only one cable

PoE Standards:

IEEE Standard	a.k.a.	Power	Note
802.3af	PoE	15.4 Watt (max)	
802.3at	PoE+	25.5 Watt (max)	
802.3bt	4PPoE	55 Watt (Level 3); 90-100Watt (Level 4)	under define by IEEE
NA	UPoE	60 Watt (max)	by CISCO

PoE applications::

- IP network cameras
- WLAN access points
- VoIP telephony
- Scanners and RFID stations
- Anywhere where voltage supply for network devices is difficult

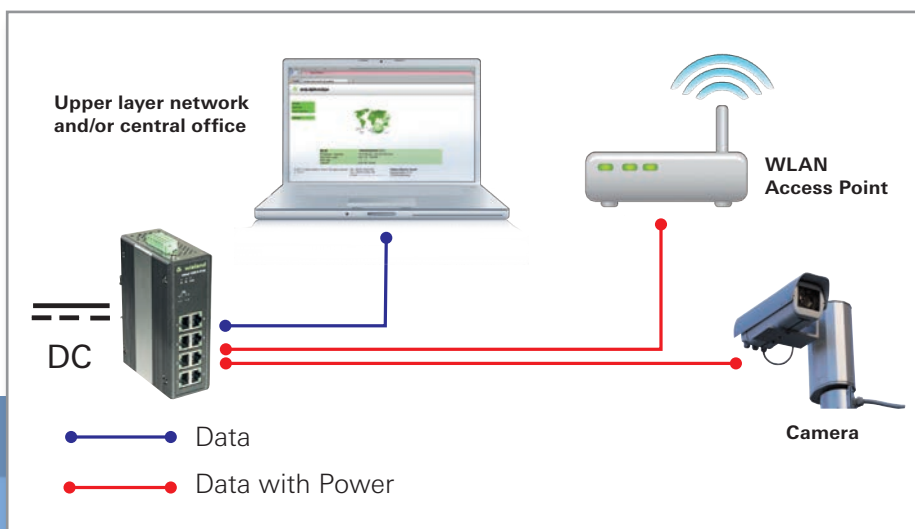

Power Over Ethernet switches (Fast-Ethernet)

wienet UMS 8-4 PoE-W

- 8 Fast Ethernet ports
- 4 PoE ports with injector function
- Broadcast power protection
- Ethernet ESD protection
- Power line EFT protection
- Redundant 24 V/48 V DC voltage supply
- With signal relay
- Extensive operating temperature range from -40 °C to 75 °C



Type	Part No.
wienet UMS 8-4 PoE-W	83.040.1203.0
Technical data	
Ethernet	
Type	Unmanaged
Number of ports	8 x 10/100Base-T(X)
PoE ports	1-4
Ethernet transfer rates	10/100 Mbps
Standards	IEEE 802.3, 802.3u, 802.3x, 802.3af
Transmission length	up to 100 m
Topology	Line, star, mesh
Power supply	
Operating voltage	24/48 V DC
Redundant power supply	2 power inputs P1, P2
Diagnostic LEDs	P1, P2, P-Fail, 10/100T(X): Link/Activity, Duplex/Collision
Power requirement	65 W at full load PoE
PoE port output	15.4 W at 48 V DC
Ambient conditions	
Operating temperature	-40 °C ... +75 °C
Storage temperature	-40 °C ... +85 °C
Rel. air humidity during operation	5 ... 95% (non-condensing)
Other technical data	
Dimensions (mm) W x H x D	48.6 x 140 x 95
Housing	Metal
Mounting	Top-hat rail, wall (mounting set)
Weight	approx. 700 g
IP rating	IP30
Relay output	in case of missing redundant voltage supply
Approvals	
	UL 508, FCC Part 15 Subpart B Class A
	EN 55022 Class A
	EN 61000-4-2, EN 61000-4-3, EN 61000-4-4,
	EN 61000-4-5, EN 61000-4-6, EN 61000-4-8
	IEC 60068-2-27, IEC 60068-2-32, IEC 60068-2-6



Light Managed Switches *wienet* LMS Series

wienet Light Managed Switches (LMS switches) close the gap between completely unmanaged switches and fully managed switches, which are complex to configure.

LMS switches combine the benefits of both (managed and unmanaged switches) and enable simple and cost-effective solutions for centralized network management.

The **wienet** LMS series uses Modbus TCP to communicate with SCADA systems. At the same time, communication with an NMS (Networking Management System) via SNMP is possible, providing full device control for responsible control engineers and/or IT engineers.

wienet LMS switches can be used in plant automation for connecting end devices with the backbone network or another network.

Benefits:

- Communication to SCADA systems via Modbus TCP
- Communication with NMS (Network Management Systems) via SNMP
- Port-based QoS (Quality of Service) for deterministic data traffic
- Jumbo Frame Support up to 2,048 bytes

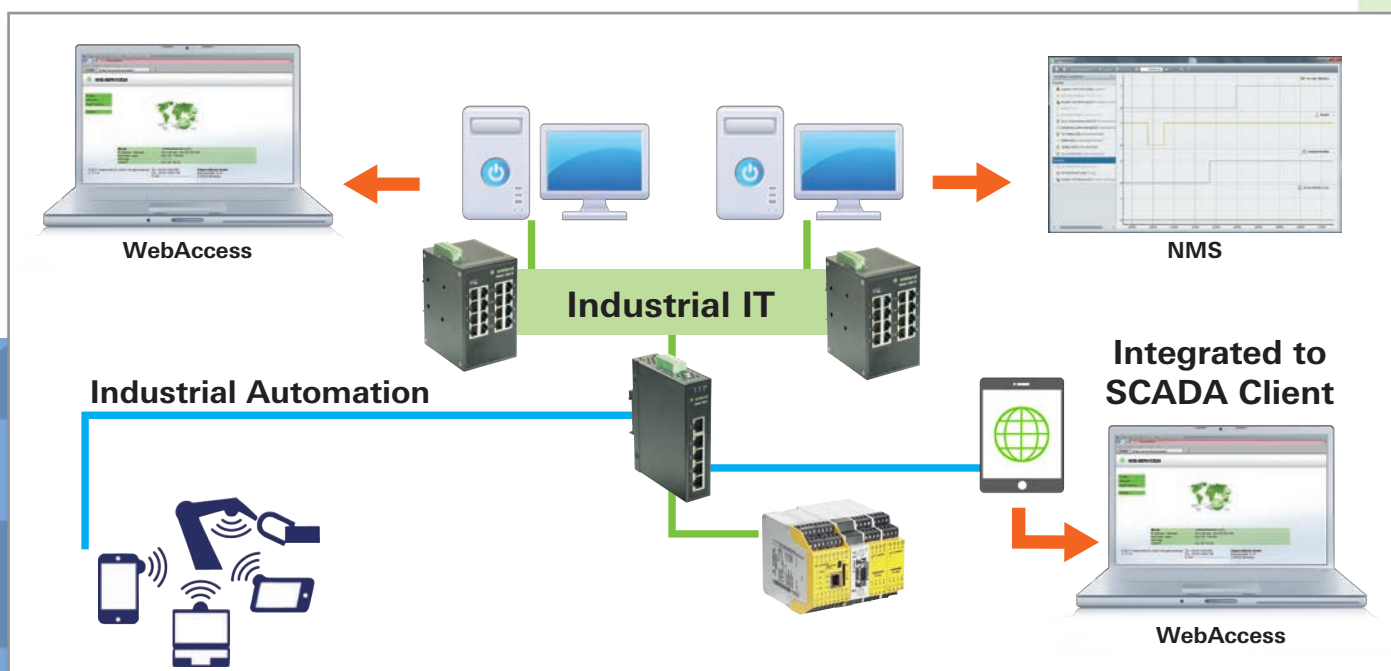

Light Managed Switches

wienet LMS 16-W

- 16 Fast Ethernet ports with Auto MDI/MDI-X
- Communication with SCADA software via Modbus TCP
- Communication with NMS (Network Management System) via SNMP
- Port-based QoS for deterministic data traffic
- EMV Level 3 protection for extreme outdoor and industrial applications
- IEEE 802.3az Energy Efficient Ethernet (EEE)
- Jumbo Frame Support (up to 2048 bytes)
- Extensive operating temperature range from -40 °C to 75 °C



Type	Part No.
wienet LMS 16-W	83.040.1334.0
Technical data	
Ethernet	
Type	Light Managed
Number of ports	16 x RJ-45 10/100Base-T(X)
Ethernet transfer rates	10/100 Mbps
Standards	IEEE 802.3, 802.3u, 802.3x, 802.31p, 802.3az, 802.3ab
Transmission length	up to 100 m
Topology	Line, star, mesh
Switch properties	
MAC table size	8 k
Package buffer	128 kbit
Switch capacitance	3.2 Gbps
Jumbo Frame	2048 bytes
Power supply	
Operating voltage	8.4 to 52.8 V DC
Redundant power supply	2 power inputs P1, P2
Diagnostic LEDs	P1, P2, P-Fail, Loop Detection10/100T (X): Link/Activity, Speed
Power requirement	Max. 3.84 W
Ambient conditions	
Operating temperature	-40 °C ... +75 °C
Storage temperature	-40 °C ... +85 °C
Rel. air humidity during operation	10 ... 95% (non-condensing)
Other technical data	
Dimensions (mm) W x H x D	74 x 120 x 84
Housing	Metal
Mounting	Top-hat rail, wall (mounting set)
Weight	approx. 700 g
IP rating	IP30
Relay output	in case of missing redundant voltage supply
Approvals	
	FCC Part 15 Subpart B Class A, EN 55011/55022 Class A
	EN 61000-4-2 (Level 3); EN 61000-4-3 2 (Level 3); EN 61000-4-4 2 (Level 3);
	EN 61000-4-5 2 (Level 3); EN 61000-4-6 2 (Level 3); EN 61000-4-8 2 (Level 3)
	IEC/EN60950, UL 60950, UL 508, Class 1 Division 2, ATEX



wienet WLAN Access Point

Description

WLAN networks are everywhere nowadays. This trend is extending to industrial applications, for which the new access point **wienet** AP-ETH-A has been developed.

Features:

- WLAN access point in industrial design
- WLAN standard IEEE 802.11n/g/b
- Ethernet 10/100BaseT
- Operating voltage 24 V DC
- IP rating IP20
- 35 mm DIN-rail mounting as per EN60715

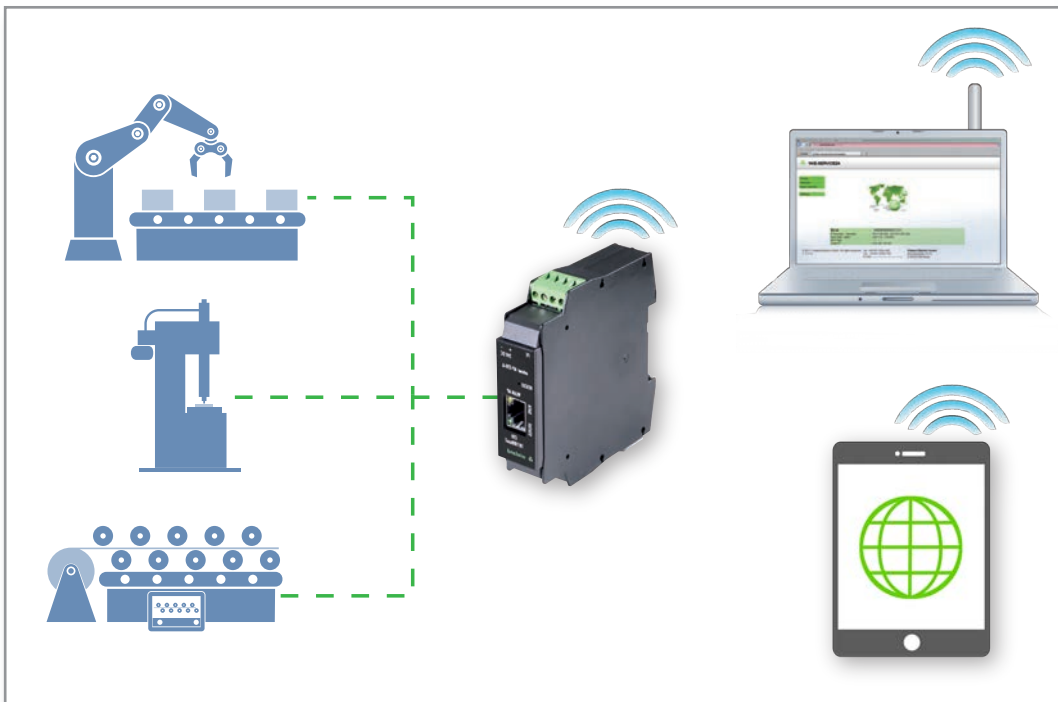

Example application:
configuration of barely accessible end devices via WLAN

Possible uses:

- | | |
|-----------------------|--|
| Access Point: | LAN → WLAN |
| WLAN router: | LAN & WLAN
WAN → WLAN |
| Network bridge: | WLAN → LAN
WLAN → WLAN (& LAN) – repeater |
| LAN cable substitute: | LAN → WLAN tunnel → LAN |

Wireless LAN Access Point 24 V DC

wienet AP-ETH-A / ...-A

- WLAN Access Point in industrial design
- WLAN standard IEEE 802.11b/g/n
- Ethernet 10/100BaseT
- Operating voltage 24 V DC
- Protection class IP20
- 35 mm DIN-rail mounting per EN60715



Type	Part No.
wienet AP-ETH-A (with integrated antenna)	83.040.0050.0
wienet AP-ETH-A-A (with antenna connector)	83.040.0051.0
Technische Daten	
Operating voltage connection	
Nominal voltage	24 V DC (Voltage range: 9 ... 28 V DC)
Output (24 V DC) approx.	1 W
Connection type	Pluggable screw terminals
Connector cross-section, fine-/single-strand or fine-strand with end ferrules	2 x 0.14 - 0.75 mm ² / 1 x 0.14 - 2.5 mm ²
WLAN	
Wireless LAN standard	IEEE 802.11n/g/b
Frequency	2.4 ... 2.4835 GHz
Data rate	max. 150 Mbit/s
Safety	WEP, WPA, WPA2 PSK + EAP
Antenna	Integrated or external via RP-SMA socket
Ethernet (LAN)	
Connection type	RJ-45 socket
Medium	Twisted pair 10/100BaseT
Environmental conditions	
Operating temperature range	-5 °C ... +55 °C
Storage temperature range	-20 °C ... +60 °C
Rel. humidity	5 ... 93 %
Condensation	Not permitted
Housing, mounting	
Housing material	Plastic, colour: black
Dimensions (W x H x D)	22.5 x 96.5 x 91.5 mm
Weight approx.	95 g
Protection type	IP 20
Mount to	35 mm DIN rail (top hat rail) per EN60715
Operation and display elements	
Button RES	< 3 sec. restart 5-30 sec. restart with factory settings
Green LED	Status display, on = o.k. / flashing = AP is starting
Yellow LED	Ethernet status, data traffic
Accessories	
wienet Antenne 15854v2 WIFI	F0.000.0037.4
wienet Antenne 15874v2 WIFI	F0.000.0037.5





- Applications**
- Energy Systems
 - Wind turbines
 - Solar farms
 - Transformer station
 - Combined heat and power units
 - Biogas cogeneration systems
 - Heat pumps, ...
 - Water and waste water management
 - System monitoring in machine building
 - Washing machines
 - Packaging machines
 - Compressors, ...
 - External surveillance camera
 - Vending
 - Telemetry online sales or ticket machines
 - Smart metering
 - Mobile fleet management

wienet VPN Industrial Router – unlimited M2M communication

Functionality which convinces

Wieland's **wienet** VPN industrial routers ensure increased efficiency and data security. Whether it is about the control of machines, monitoring of production lines or the coordination of all production areas a permanent communication between devices is needed to complete such a complex task. Access to stored data using wireless networks is not always possible or safe. Now Wieland develops with its modern router technology new fields of applications. For example control commands, level indicators or video signals can now be transmitted. At download speeds of up to 100 Mbit/s and upload speeds of up to 50 Mbits/s (depending on the network operator) the **wienet** VPN industrial router is sure to cover the available connectivity options of GPRS up to LTE. With automatic login wienet VPN industrial router will always access the fastest available connection.

Each router has its own IP address and can be configured through the integrated web interface.

It supports services such as DHCP, NAT and DynDNS. The routers communicate directly or via the control panel to open a secure VPN connection. The establishment of an IPSec encrypted tunnel is alternatively possible.

wienet VPN routers are ideal components for industrial use in conjunction with VPN-service portals, such as Wie-Service24.

With the arrangement of the ports on the frontpanel and a standard USB port, the **wienet** VPN industrial router are extremely user friendly. A clear statistic of mobile connections is used for better control. Optionally, the devices are available with a second SIM card slot, additional I/O, RS-232, RS-422/RS-485, M-Bus, several Ethernet interfaces, WiFi module or integrated 3 or 5 port switch.



Advantages

- Expanded operating temperature range of -40°C to 75°C
- DIN top hat rail assembly
- An extremely robust aluminium housing

Industrial mobile router WR-LTE v3

wienet WR-LTE v3 SL

- High-performance CPU Cortex A8, 1 GHz (2000 DMIPS)
- Memory: 256 MB flash memory, 512 MB RAM, 128 kB M-RAM
- 2x SIM card slot (Mini SIM 2FF)
- 2x or 5x Ethernet
- 1x RJ45 port expansion RS232 or RS485/422
- 1x USB 2.0 host
- 2x DI
- 1x DO
- 1x MicroSD
- 3 antenna ports: Main, DIV, GPS, WIFI (optional)
- 1x WIFI/WLAN 802.11 b/g/n (optional), supports access point and client mode

Delivery scope:

- VPN mobile router
- Including mobile radio antennas and WIFI antenna (optional)
- Including USB stick with documentation
- Including RJ45 patch cable
- Including DIN rail (top hat rail) adapter



Type	Interfaces	Part No.
wienet WR-LTE v3 SL		
WR-LTE v3 SL	2x LAN, USB, 2DI, 1DO, 2x SIM	83.041.0700.1
WR-LTE v3 SL WIFI	2x LAN, USB, 2DI, 1DO, 2x SIM, WIFI	83.041.0760.1
WR-LTE v3 SL RS232	2x LAN, USB, 2DI, 1DO, 2x SIM, RS232	83.041.0701.1
WR-LTE v3 SL RS232+RS422/485	2x LAN, USB, 2DI, 1DO, 2x SIM, RS232+RS422/485	83.041.0702.1
WR-LTE v3 SL RS232+RS422/485 WIFI	2x LAN, USB, 2DI, 1DO, 2x SIM, RS232+RS422/485, WIFI	83.041.0762.1
WR-LTE v3 SL 5-Port	5x LAN, USB, 2DI, 1DO, 2x SIM	83.041.0709.1
WR-LTE v3 SL 5-Port WIFI	5x LAN, USB, 2DI, 1DO, 2x SIM, WIFI	83.041.0769.1
Networks		
DHCP - automatic IP address in LAN network	NAT/PAT - Network/Port Address Translation	
SNMP v1/v2c/v3 - Network management, communication to router and its I/O and M-Bus modules	VRRP - redundant communication paths (routing)	
DynDNS - access to router if dynamic IP used	Dial-In - Dial-up router option (network) - communication via "CSD call"	
Integrated firewall (SPI)	OSPF, BGP, RIP - routing protocols (optional)	
VLAN, QoS - expanded Layer 2 network functions (optional)	DMVPN	
PPPoE bridge	IGMP, BGP, OSPF, RIP, SMTP, SMTPS	
VPN tunnel		
Secure data encryption with IPSec and OpenVPN (including X.509 certificates)	Basic data transmission without encoding via GRE and L2TP tunnel	
EasyVPN		
Configuration and diagnostics		
Configuration and firmware update via Web interface, USB stick and central Internet server	Remote router maintenance via SMS - switch Internet connection on and off, change SIM card, switch digital output, query status information	
Change between different configuration profiles (via Web interface, SMS, digital input or scheduler)	Comprehensive mobile radio statistics options (reception strength, radio cell, adjacent cell, transported volume, connection cancellations, etc.)	
LED status display	Network status	
Mobile radio status	One-CLICK reports: Current configuration, system log, routing table, reboot log, kernel log	
SNMP v1/v2c/v3 - status query		
Optional expansions		
Second SIM card - redundancy to protect communication when roaming; data volume used and active digital input (DI)	User (software) module - various function expansions	
Wie-Service24 - VPN server portal		
Additional functions and characteristics		
NTP client, NTP server - time synchronization	Communication via SMS - AT commands to the RS232, Ethernet and I/O interface	
Script programming - StartUp script, Up/Down script	Script language Bash, Python	
Technical data		
Mounting	DIN rail (top hat rail) or table	
Operating voltage	10 - 60 V DC	
Power consumption typical / average / peak / sleep mode	2.5 W / 4 W / 11 W / 10 mW	
Operating temperature / storage temperature	-30 ... +60 °C / -40 ... +85 °C	
Humidity	0 ... 95 %	
Protection type	IP30	
On-board I/O	6-pin plug-in socket	
- Output (DO)	300 mA / max. 60 V	
- 2x input (DI)	10-60 V DC	
Dimensions (HxWxD)	125 x 55 x 97	
Weight	375 g	
Antenna connector		
- ANT + DIV mobile radio antenna	SMA	
- GPS antenna	SMA	
- WIFI antenna (optional)	R-SMA	
Frequency bands		
- GSM/GPRS/EDGE	900/1800/1900 MHz	
- UMTS	900/2100 MHz	
- HSPA+	900/2100 MHz	
- LTE	800/900/1800/2100/2600 MHz	
Bit rates		
- Download Upload GPRS/edge	Max. 236.7 kbit/s Max. 118.4 kbit/s	
- Download Upload UMTS/HSPA+	Max. 21.1 Mbit/s Max. 5.76 Mbit/s	
- Download Upload LTE	Max. 100 Mbit/s Max. 50 Mbit/s	
Technical data GPS		
- Protocol	NMEA 0183 v3.0	
- Frequency	1575.42 MHz	
- Antenna	50 Ohm - active	
Technical data microSD		
- Supported technologies	SDHC, SDXC	
- Supported capacities	SDHC to 32 GB, SDXC from 32 GB to 64 GB	
Complies with standards	EN 61000-4-2 (ESD), IEC 61000-4-3 (RF field AM modulated), EN 61000-4-4 (fast transient), EN 61000-4-5 (surge), EN 61000-4-6 (RF-conducted), EN 55022, EN 61000-4-8, EN 60068-2-2, EN 60068-2-1, EN 60068-2-78, E8 10R-04	

Industrial mobile router 4G LTE v2

wienet LTE LR77 v2 SL „Basic“

- 1x SIM card slot
- 1x Ethernet
- 1x RJ45 port expansion
- 1x USB
- 1x DI
- 1x DO

wienet LTE LR77v2 SL „Compact“

- 2x SIM card slot
- 2x Ethernet (LAN-to-LAN or switch-bridge)
- Best price-performance ratio
- No USB interface
- No DIO

wienet LTE LR77v2 SL „Full“

- 2x SIM card slot
- 1x Ethernet
- 2x RJ45 port expansion
- 1x USB
- 1x DI
- 1x DO
- GPS receiver (not in combination with WIFI)

Delivery scope:

- VPN mobile router
- Including antennas
- Including USB stick with documentation
- Including RJ45 patch cable
- Including DIN rail (top hat rail) adapter



Type	Interfaces	Part No.
wienet LR77v2 SL Basic		
LR77v2	LAN, USB, DI, DO, 1xSIM	83.041.0050.1
LR77v2 RS232	LAN, USB, DI, DO, 1xSIM, RS232	83.041.0051.1
LR77v2 RS485/422	LAN, USB, DI, DO, 1xSIM, RS485/422	83.041.0052.1
LR77v2 MBUS	LAN, USB, DI, DO, 1xSIM, M-Bus	83.041.0053.1
LR77v2 CNT	LAN, USB, 5DI, 3DO, 2AI, 1xSIM	83.041.0054.1
LR77v2 ETH	2x LAN, USB, DI, DO, 1xSIM	83.041.0055.1
wienet LR77v2 SL Compact		
LR77v2c SL ETH	2x LAN, 2xSIM	83.041.0505.3
LR77v2c SL ETH WIFI	2x LAN, WIFI, 2xSIM	83.041.0565.3
wienet LR77v2 SL Full		
LR77v2f SL	LAN, USB, DI, DO, 2xSIM	83.041.0500.1
LR77v2f SL RS232	LAN, USB, DI, DO, 2xSIM, RS232	83.041.0501.1
LR77v2f SL RS485/422	LAN, USB, DI, DO, 2xSIM, RS485/422	83.041.0502.1
LR77v2f SL MBUS	LAN, USB, DI, DO, 2xSIM, M-Bus	83.041.0503.1
LR77v2f SL CNT	LAN, USB, 5DI, 3DO, 2AI, 2xSIM	83.041.0504.1
LR77v2f SL ETH	2xLAN, USB, DI, DO, 2xSIM	83.041.0505.1
LR77v2f SL WIFI	LAN, USB, DI, DO, 2xSIM, WIFI	83.041.0560.1
LR77v2f SL RS232 RS232	LAN, USB, DI, DO, 2xSIM, 2xRS232	83.041.0511.1
LR77v2f SL RS485 RS232	LAN, USB, DI, DO, 2xSIM, RS232, RS485/422	83.041.0512.1
LR77v2f SL MBUS RS232	LAN, USB, DI, DO, 2xSIM, RS232, M-Bus	83.041.0513.1
LR77v2f SL CNT RS232	LAN, USB, 5xDI, 3xDO, 2xAI, 2xSIM, RS232	83.041.0514.1
LR77v2f SL ETH RS232	2xLAN, USB, DI, DO, 2xSIM, RS232	83.041.0515.1
LR77v2f SL RS485 RS485	LAN, USB, DI, DO, 2xSIM, 2xRS485/422	83.041.0522.1
LR77v2f SL MBUS RS485	LAN, USB, DI, DO, 2xSIM, RS485/422, M-Bus	83.041.0523.1
LR77v2f SL CNT RS485	LAN, USB, 5xDI, 3xDO, 2xAI, 2xSIM, RS485/422	83.041.0524.1
LR77v2f SL ETH RS485	2xLAN, USB, DI, DO, 2xSIM, RS485/422	83.041.0525.1
LR77v2f SL RS232 WIFI	LAN, USB, DI, DO, 2xSIM, WIFI, RS232	83.041.0561.1
LR77v2f SL RS485 WIFI	LAN, USB, DI, DO, 2xSIM, WIFI, RS485/422	83.041.0562.1
LR77v2f SL MBUS WIFI	LAN, USB, DI, DO, 2xSIM, WIFI, M-Bus	83.041.0563.1
LR77v2f SL CNT WIFI	LAN, USB, 5xDI, 3xDO, 2xAI, 2xSIM, WIFI	83.041.0564.1
LR77v2f SL ETH WIFI	2xLAN, USB, DI, DO, 2xSIM, WIFI	83.041.0565.1
LR77v2f SL 3-Port	3xLAN, USB, DI, DO, 2xSIM	83.041.0599.1
Networks		
DHCP - automatic IP address in LAN network	NAT/PAT - Network/Port Address Translation	
SNMP - network management, communication to router and its I/O and M-Bus modules	VRRP - redundant communication paths (routing)	
DynDNS - access to router if dynamic IP used	Dial-In - Dial-up router option (network) - communication via "CSD call"	
Integrated firewall (SPI)	OSPF, BGP, RIP - routing protocols (optional)	
VLAN, QoS - expanded Layer 2 network functions (optional)		
VPN tunnel		
Secure data encryption with IPSec and OpenVPN (including X.509 certificates)	Basic data transmission without encoding via GRE and L2TP tunnel	
Configuration and diagnostics		
Web interface	SMS functions	
Several profiles	Comprehensive mobile radio statistics options	
LED status display	Telnet and SSH - command line access	
Optional expansions		
Second SIM card	User (software) module - various function expansions	
Wie-Service24 - VPN server portal		
Additional functions and characteristics		
NTP client, NTP server - time synchronization	Communication via SMS - AT commands to the RS232, Ethernet and I/O interface	
Technical data		
Mounting	DIN rail (top hat rail) or table	
Operating voltage	10 - 30 V DC	
Power consumption	5.5 W max.	
Operating temperature	-30 ... +60 °C	
On-board I/O		
- PIN allocation	DO/GND/DI	
- Output (DO)	120 mA / max. 30 V	
- Input (DI)	10-30 V DC	
Dimensions (HxWxD)	42 x 80.5 x 113.5 mm	
Weight	270 g	
Antenna connector	2x SMA - 50 Ohm	
Frequency bands		
- GSM/GPRS/EDGE	900/1800/1900 MHz	
- UMTS	850/2100 MHz	
- LTE	800/900/1800/2100/2600 MHz	
Download Upload UMTS	Max. 42 Mbit/s Max. 5.7 Mbit/s	
Download Upload LTE	Max. 100 Mbit/s Max. 50 Mbit/s	
Complies with standards		
	CE, E8	
	EN 61000-4-3, EN 61000-4-8	
	EN 55022, E8 10R-04 7056	



Industrial mobile router 3G UMTS/HSDPA/HSUPA/HSPA+ v2

wienet HSPA+ UR5iv2 SL „Basic“

- 1x SIM card slot
- 1x Ethernet
- 1x RJ45 port expansion
- 1x USB
- 1x DI
- 1x DO

wienet HSPA+ UR5iv2 SL „Compact“

- 2x SIM card slot
- 2x Ethernet (LAN-to-LAN or switch-bridge)
- Best price-performance ratio
- No USB interface
- No DIO

wienet HSPA+ UR5iv2 SL „Full“

- 2x SIM card slot
- 1x Ethernet
- 2x RJ45 port expansion
- 1x USB
- 1x DI
- 1x DO
- GPS receiver (not in combination with WIFI)

Delivery scope:

- VPN mobile router
- Including USB stick with documentation
- Including RJ45 patch cable
- Including DIN rail (top hat rail) adapter



Type	Interfaces	Part No.
wienet UR5iv2 SL Basic		
UR5iv2	LAN, USB, DI, DO, 1xSIM	83.041.0040.1
UR5iv2 RS232	LAN, USB, DI, DO, 1xSIM, RS232	83.041.0041.1
UR5iv2 RS485/422	LAN, USB, DI, DO, 1xSIM, RS485/422	83.041.0042.1
UR5iv2 MBUS	LAN, USB, DI, DO, 1xSIM, M-Bus	83.041.0043.1
UR5iv2 CNT	LAN, USB, 5DI, 3DO, 2AI, 1xSIM	83.041.0044.1
UR5iv2 ETH	2x LAN, USB, DI, DO, 1xSIM	83.041.0045.1
wienet UR5iv2 SL Compact		
UR5iv2c SL ETH	2x LAN, 2xSIM	83.041.0405.3
UR5iv2c SL ETH WIFI	2x LAN, WIFI, 2xSIM	83.041.0465.3
wienet UR5iv2 SL Full		
UR5iv2f SL	LAN, USB, DI, DO, 2xSIM	83.041.0400.1
UR5iv2f SL RS232	LAN, USB, DI, DO, 2xSIM, RS232	83.041.0401.1
UR5iv2f SL RS485/422	LAN, USB, DI, DO, 2xSIM, RS485/422	83.041.0402.1
UR5iv2f SL MBUS	LAN, USB, DI, DO, 2xSIM, M-Bus	83.041.0403.1
UR5iv2f SL CNT	LAN, USB, 5DI, 3DO, 2AI, 2xSIM	83.041.0404.1
UR5iv2f SL ETH	2xLAN, USB, DI, DO, 2xSIM	83.041.0405.1
UR5iv2f SL WIFI	LAN, USB, DI, DO, 2xSIM, WIFI	83.041.0460.1
UR5iv2f SL RS232 RS232	LAN, USB, DI, DO, 2xSIM, 2xRS232	83.041.0411.1
UR5iv2f SL RS485 RS232	LAN, USB, DI, DO, 2xSIM, RS232, RS485/422	83.041.0412.1
UR5iv2f SL MBUS RS232	LAN, USB, DI, DO, 2xSIM, RS232, M-Bus	83.041.0413.1
UR5iv2f SL CNT RS232	LAN, USB, 5xDI, 3xDO, 2xAI, 2xSIM, RS232	83.041.0414.1
UR5iv2f SL ETH RS232	2xLAN, USB, DI, DO, 2xSIM, RS232	83.041.0415.1
UR5iv2f SL RS485 RS485	LAN, USB, DI, DO, 2xSIM, 2xRS485/422	83.041.0422.1
UR5iv2f SL MBUS RS485	LAN, USB, DI, DO, 2xSIM, RS485/422, M-Bus	83.041.0423.1
UR5iv2f SL CNT RS485	LAN, USB, 5xDI, 3xDO, 2xAI, 2xSIM, RS485/422	83.041.0424.1
UR5iv2f SL ETH RS485	2xLAN, USB, DI, DO, 2xSIM, RS485/422	83.041.0425.1
UR5iv2f SL RS232 WIFI	LAN, USB, DI, DO, 2xSIM, WIFI, RS232	83.041.0461.1
UR5iv2f SL RS485 WIFI	LAN, USB, DI, DO, 2xSIM, WIFI, RS485/422	83.041.0462.1
UR5iv2f SL MBUS WIFI	LAN, USB, DI, DO, 2xSIM, WIFI, M-Bus	83.041.0463.1
UR5iv2f SL CNT WIFI	LAN, USB, 5xDI, 3xDO, 2xAI, 2xSIM, WIFI	83.041.0464.1
UR5iv2f SL ETH WIFI	2xLAN, USB, DI, DO, 2xSIM, WIFI	83.041.0465.1
UR5iv2f SL 3-Port	3xLAN, USB, DI, DO, 2xSIM	83.041.0499.1
Networks		
DHCP - automatic IP address in LAN network	NAT/PAT - Network/Port Address Translation	
SNMP - network management, communication to router and its I/O and M-Bus modules	VRRP - redundant communication paths (routing)	
DynDNS - access to router if dynamic IP used	Dial-In - Dial-up router option (network) - communication via "CSD call"	
Integrated firewall (SPI)	OSPF, BGP, RIP - routing protocols (optional)	
VLAN, QoS - expanded Layer 2 network functions (optional)		
VPN tunnel		
Secure data encryption with IPSec and OpenVPN (including X.509 certificates)	Basic data transmission without encoding via GRE and L2TP tunnel	
Configuration and diagnostics		
Web interface	SMS functions	
Several profiles	Comprehensive mobile radio statistics options	
LED status display	Telnet and SSH - command line access	
Optional expansions		
Second SIM card	User (software) module - various function expansions	
Wie-Service24 - VPN server portal		
Additional functions and characteristics		
NTP client, NTP server - time synchronization	Communication via SMS - AT commands to the RS232, Ethernet and I/O interface	
Technical data		
Mounting	DIN rail (top hat rail) or table	
Operating voltage	10 - 30 V DC	
Power consumption	5.5 W max.	
Operating temperature	-30 ... +60 °C	
On-board I/O		
- PIN allocation	DO/GND/DI	
- Output (DO)	120 mA / max. 30 V	
- Input (DI)	10-30 V DC	
Dimensions (HxWxD)	42 x 80.5 x 113.5 mm	
Weight	287 g	
Antenna connector	2x SMA - 50 Ohm	
Frequency bands		
- GSM/GPRS/EDGE	800/900/1800/1900 MHz	
- UMTS	850/900/1900/2100 MHz	
Complies with standards		
	CE, E8	
	EN 61000-4-3, EN 61000-4-8	
	EN 55022, E8 10R-04 7056	

Industrial LAN router

wienet WR-LAN v3 SL

- High-performance CPU Cortex A8, 1 GHz (2000 DMIPS)
- Memory: 256 MB flash memory, 512 MB RAM, 128 kB M-RAM
- 5x Ethernet
- 1x USB 2.0 host
- 2x DI
- 1x DO
- 1x MicroSD
- 1x WIFI/WLAN 802.11 b/g/n (optional), supports access point and client mode

Delivery scope:

- VPN LAN router
- Including USB stick with documentation
- Including RJ45 patch cable
- Including DIN rail (top hat rail) adapter



Type	Interfaces	Part No.
wienet WR-LANv3 SL		
WR-LAN v3 SL 5-Port	5xLAN, USB, DI, DO	83.041.0809.1
WR-LAN v3 SL 5-Port WIFI	5xLAN, USB, DI, DO, WIFI	83.041.0869.1
Networks		
DHCP - automatic IP address in LAN network	NAT/PAT - Network/Port Address Translation	
SNMP v1/v2c/v3 - Network management, communication to router and its I/O and M-Bus modules	VRRP - redundant communication paths (routing)	
PPPoE bridge	DynDNS - access to router if dynamic IP used	
IGMP, BGP, OSPF, RIP, SMTP, SMTPS	OSPF, BGP, RIP - routing protocols (optional)	
Integrated firewall (SPI)	VLAN, QoS - expanded Layer 2 network functions (optional)	
DMVPN	HTTPS, SSH, SFTP	
VPN tunnel		
Secure data encryption with IPSec and OpenVPN (including X.509 certificates)	Basic data transmission without encoding via GRE and L2TP tunnel	
EasyVPN		
Configuration and diagnostics		
Configuration and firmware update via Web interface, USB stick and central Internet server	One-CLICK reports: Current configuration, system log, routing table, reboot log, kernel log	
LED status display	Change between different configuration profiles (via Web digital input, or scheduler)	
SNMP v1/v2c/v3 - status query	Network status	
Optional expansions		
Wie-Service24 - VPN server portal	User (software) module - various function expansions	
Additional functions and characteristics		
Script programming - StartUp script, Up/Down script	NTP client, NTP server - time synchronization	
Script language Bash, Python		
Technical data		
Mounting	DIN rail (top hat rail) or table	
Operating voltage	10 - 60 V DC	
Power consumption typical / average / peak / sleep mode	2 W / 3.25 W / 4.5 W / 10 mW	
Operating temperature / storage temperature	-30 ... +60 °C / -40 ... +85 °C	
Humidity	0 ... 95 %	
Protection type	IP30	
On-board I/O		
- Output (DO)	300 mA / max. 60 V	
- 2x input (DI)	10-60 V DC	
Dimensions (HxWxD)	125 x 55 x 97	
Weight	327 g	
Antenna connector		
- WIFI antenna (optional)	R-SMA	
Technical data microSD		
- Supported technologies	SDHC, SDXC	
- Supported capacities	SDHC to 32 GB, SDXC from 32 GB to 64 GB	
Complies with standards	EN 61000-4-2 (ESD), IEC 61000-4-3 (RF field AM modulated), EN 61000-4-4 (fast transient), EN 61000-4-5 (surge)	
	EN 61000-4-6 (RF-conducted), EN 55022, EN 61000-4-8,	
	EN 60068-2-2, EN 60068-2-1, EN 60068-2-78, E8 10R-04	



Industrial LAN router

wienet LAN Router XR5iv2 SL

- 1x Ethernet
- 1x RJ45 port expansion
- 1x USB
- 1x DI
- 1x DO

wienet LAN Router XR5iv2 SL „compact“

- 2x Ethernet (LAN-to-LAN or switch-bridge)
- Best price-performance ratio
- No USB interface
- No DIO

Delivery scope:

- VPN LAN router
- Including USB stick with documentation
- Including RJ45 patch cable
- Including DIN rail (top hat rail) adapter



Type	Interfaces	Part No.
wienet XR5iv2 SL		
XR5iv2 ETH	2xLAN, USB, DI, DO	83.041.0605.1
XR5iv2 ETEH RS232	2xLAN, USB, DI, DO, RS232	83.041.0615.1
XR5iv2 ETH RS485/422	2xLAN, USB, DI, DO, RS485/422	83.041.0625.1
XR5iv2 ETH MBUS	2xLAN, USB, DI, DO, M-Bus	83.041.0635.1
XR5iv2f SL WIFI	LAN, USB, DI, DO, WIFI	83.041.0660.1
XR5iv2f SL RS232 WIFI	LAN, USB, DI, DO, WIFI, RS232	83.041.0661.1
XR5iv2f SL RS485 WIFI	LAN, USB, DI, DO, WIFI, RS485/422	83.041.0662.1
XR5iv2f SL MBUS WIFI	LAN, USB, DI, DO, WIFI, M-Bus	83.041.0663.1
XR5iv2f SL CNT WIFI	LAN, USB, 5xDI, 3xDO, 2xAI, WIFI	83.041.0664.1
XR5iv2f SL ETH WIFI	2xLAN, USB, DI, DO, WIFI	83.041.0665.1
wienet XR5iv2 SL Compact		
XR5iv2c SL ETH	2x LAN	83.041.0605.3
XR5iv2c SL ETH WIFI	2x LAN, WIFI	83.041.0665.3
Networks		
DHCP - automatic IP address in LAN network	NAT/PAT - Network/Port Address Translation	
SNMP - network management, communication to router and its I/O and M-Bus modules	VRRP - redundant communication paths (routing)	
Integrated firewall (SPI)	DynDNS - access to router if dynamic IP used	
VLAN, QoS - expanded Layer 2 network functions (optional)	OSPF, BGP, RIP - routing protocols (optional)	
PPPoE - DSL modem support		
VPN tunnel		
Secure data encryption with IPSec and OpenVPN (including X.509 certificates)	Basic data transmission without encoding via GRE and L2TP tunnel	
Configuration and diagnostics		
Web interface	Several profiles	
LED status display	Telnet and SSH - command line access	
Optional expansions		
User (software) module - various function expansions	Wie-Service24 - VPN server portal	
Additional functions and characteristics		
NTP client, NTP server - time synchronization		
Technical data		
Mounting	DIN rail (top hat rail) or table	
Operating voltage	10 - 30 V DC	
Power consumption	5.5 W max.	
Operating temperature	-30 ... +60 °C	
On-board I/O		
- PIN allocation	DO/GND/DI	
- Output (DO)	120 mA / max. 30 V	
- 2x input (DI)	10-30 V DC	
Dimensions (HxWxD)	42 x 80.5 x 113.5 mm	
Weight	270 g	
Complies with standards	CE	
	EN 61000-4-3, EN 61000-4-8	
	EN 55022	

Accessories

Round beam roof antenna
wienet Antenna LPB-7-27



Type	Part No.
wienet Antenne 15863-v2	F0.000.0035.1
Technical data	
Frequency range	GSM, GPRS, EDGE, UMTS, LTE
Connector	SMA/M
Gain	4 dBi
Cable length	5 m
Dimensions (mm)	Approx. 82 x 48 x 48
Mounting	Including mast or wall mounting bracket

Magnetic holder for antennas with SMA/M connection
wienet Antenna 15018



Type	Part No.
wienet Antenne 15018	F0.000.0036.1
Technical data	
Frequency range	GSM, GPRS, EDGE, UMTS, LTE
Antenna connector	SMA/F
Cable connector	SMA/M
Cable length	2.5 m
Dimensions (H x ø)	42/50 mm
Mounting	Magnetic holder

LTE antenna
wienet Antenna 15018A



Type	Part No.
wienet Antenne 15018A	F0.000.0036.2
Technical data	
Frequency range	GSM, GPRS, EDGE, UMTS, LTE
Cable connector	2x SMA/M
Gain	Max. 5 dBi
Dimensions	Height approx. 240 mm

Vehicle antenna
wienet Antenna 15869v2



Type	Part No.
wienet Antenne 15869v2	F0.000.0035.2
Technical data	
Frequency range	GSM, GPRS, EDGE, UMTS, LTE
Radio technology	Supports MiMo and Diversity (no directional radio)
Cable connector	2x SMA/M
Gain	Max. 5 dBi
Cable length	2 x 5 m
Dimensions (H x ø)	82 x 176 mm
Mounting	Roof mounting

LTE panel antenna
wienet Antenna 15862v2
High-performance outdoor antenna for LTE



Type	Part No.
wienet Antenne 15862v2	F0.000.0037.6
Technical data	
Frequency range	GSM, GPRS, EDGE, UMTS, LTE
Cable connector	2x SMA/M
Gain	Max. 5 dBi
Cable length	2 x 5 m
Dimensions	186 x 155 mm
Mounting	Wall or mast mounting, including wall holder





LTE panel antenna
wienet Antenna 15872v2
High-performance outdoor antenna for LTE



Type	Part No.
wienet Antenne 15872v2	F0.000.0037.8
Technical data	
Frequency range	GSM, GPRS, EDGE, UMTS, LTE
Cable connector	2x SMA/M
Gain	Max. 9 dBi
Cable length	2 x 5 m
Dimensions	230 x 180 mm
Mounting	Wall or mast mounting, including wall holder



Accessories

<p>Round beam Rod antenna wienet GXS606</p> 	<table border="1"> <thead> <tr> <th>Type</th> <th>Part No.</th> </tr> </thead> <tbody> <tr> <td>wienet GXS606</td> <td>83.041.0210.0</td> </tr> <tr> <td colspan="2">Technical data</td> </tr> <tr> <td>Frequency range</td> <td>GSM, GPRS, EDGE, UMTS</td> </tr> <tr> <td>Connector</td> <td>FME/F</td> </tr> <tr> <td>Gain</td> <td>2.2 dBi</td> </tr> <tr> <td>Cable length</td> <td>5 m</td> </tr> <tr> <td>Rod length (mm)</td> <td>Approx. 300</td> </tr> </tbody> </table>	Type	Part No.	wienet GXS606	83.041.0210.0	Technical data		Frequency range	GSM, GPRS, EDGE, UMTS	Connector	FME/F	Gain	2.2 dBi	Cable length	5 m	Rod length (mm)	Approx. 300								
Type	Part No.																								
wienet GXS606	83.041.0210.0																								
Technical data																									
Frequency range	GSM, GPRS, EDGE, UMTS																								
Connector	FME/F																								
Gain	2.2 dBi																								
Cable length	5 m																								
Rod length (mm)	Approx. 300																								
<p>Flat antenna wienet GXR623</p> 	<table border="1"> <thead> <tr> <th>Type</th> <th>Part No.</th> </tr> </thead> <tbody> <tr> <td>wienet GXR623</td> <td>83.041.0200.0</td> </tr> <tr> <td colspan="2">Technical data</td> </tr> <tr> <td>Frequency range</td> <td>GSM, GPRS, EDGE, UMTS</td> </tr> <tr> <td>Connector</td> <td>SMA/M</td> </tr> <tr> <td>Gain</td> <td>2.2 dBi</td> </tr> <tr> <td>Cable length</td> <td>2.5 m</td> </tr> <tr> <td>Dimensions (mm)</td> <td>Approx. 75 x 80 x 13</td> </tr> </tbody> </table>	Type	Part No.	wienet GXR623	83.041.0200.0	Technical data		Frequency range	GSM, GPRS, EDGE, UMTS	Connector	SMA/M	Gain	2.2 dBi	Cable length	2.5 m	Dimensions (mm)	Approx. 75 x 80 x 13								
Type	Part No.																								
wienet GXR623	83.041.0200.0																								
Technical data																									
Frequency range	GSM, GPRS, EDGE, UMTS																								
Connector	SMA/M																								
Gain	2.2 dBi																								
Cable length	2.5 m																								
Dimensions (mm)	Approx. 75 x 80 x 13																								
<p>WLAN/WIFI antenna wienet Antenna 15854v2 WIFI</p> 	<table border="1"> <thead> <tr> <th>Type</th> <th>Part No.</th> </tr> </thead> <tbody> <tr> <td>wienet Antenne 1 5854v2 WIFI</td> <td>F0.000.0037.4</td> </tr> <tr> <td colspan="2">Technical data</td> </tr> <tr> <td>Frequency range</td> <td>2.4 GHz ISM band for WIFI/WLAN, Bluetooth or Zigbee</td> </tr> <tr> <td>Connector</td> <td>SMA/M-RP</td> </tr> <tr> <td>Cable</td> <td>RG 174</td> </tr> <tr> <td>Gain</td> <td>4.8 dBi</td> </tr> <tr> <td>Polarization</td> <td>Vertical</td> </tr> <tr> <td>Resistor</td> <td>50 Ohm</td> </tr> <tr> <td>Cable length</td> <td>2.5 m</td> </tr> <tr> <td>Dimensions</td> <td>223 x 29 mm</td> </tr> <tr> <td>Mounting</td> <td>Roof mounting</td> </tr> </tbody> </table>	Type	Part No.	wienet Antenne 1 5854v2 WIFI	F0.000.0037.4	Technical data		Frequency range	2.4 GHz ISM band for WIFI/WLAN, Bluetooth or Zigbee	Connector	SMA/M-RP	Cable	RG 174	Gain	4.8 dBi	Polarization	Vertical	Resistor	50 Ohm	Cable length	2.5 m	Dimensions	223 x 29 mm	Mounting	Roof mounting
Type	Part No.																								
wienet Antenne 1 5854v2 WIFI	F0.000.0037.4																								
Technical data																									
Frequency range	2.4 GHz ISM band for WIFI/WLAN, Bluetooth or Zigbee																								
Connector	SMA/M-RP																								
Cable	RG 174																								
Gain	4.8 dBi																								
Polarization	Vertical																								
Resistor	50 Ohm																								
Cable length	2.5 m																								
Dimensions	223 x 29 mm																								
Mounting	Roof mounting																								
<p>WLAN/WIFI roof or wall antenna wienet Antenna 15874v2 WIFI</p> 	<table border="1"> <thead> <tr> <th>Type</th> <th>Part No.</th> </tr> </thead> <tbody> <tr> <td>wienet Antenne 15874v2 WIFI</td> <td>F0.000.0037.5</td> </tr> <tr> <td colspan="2">Technical data</td> </tr> <tr> <td>Frequency range</td> <td>2.4 GHz ISM band for WIFI/WLAN, Bluetooth or Zigbee</td> </tr> <tr> <td>Connector</td> <td>SMA/R</td> </tr> <tr> <td>Gain</td> <td>4.8 dBi</td> </tr> <tr> <td>Resistor</td> <td>50 Ohm</td> </tr> <tr> <td>Cable length</td> <td>5 m</td> </tr> <tr> <td>Dimensions (mm)</td> <td>Approx. 82 x 48 x 48</td> </tr> <tr> <td>Mounting</td> <td>Including mast or wall mounting bracket</td> </tr> </tbody> </table>	Type	Part No.	wienet Antenne 15874v2 WIFI	F0.000.0037.5	Technical data		Frequency range	2.4 GHz ISM band for WIFI/WLAN, Bluetooth or Zigbee	Connector	SMA/R	Gain	4.8 dBi	Resistor	50 Ohm	Cable length	5 m	Dimensions (mm)	Approx. 82 x 48 x 48	Mounting	Including mast or wall mounting bracket				
Type	Part No.																								
wienet Antenne 15874v2 WIFI	F0.000.0037.5																								
Technical data																									
Frequency range	2.4 GHz ISM band for WIFI/WLAN, Bluetooth or Zigbee																								
Connector	SMA/R																								
Gain	4.8 dBi																								
Resistor	50 Ohm																								
Cable length	5 m																								
Dimensions (mm)	Approx. 82 x 48 x 48																								
Mounting	Including mast or wall mounting bracket																								
<p>Antenna extension wienet Antenna 15815v2</p> 	<table border="1"> <thead> <tr> <th>Type</th> <th>Part No.</th> </tr> </thead> <tbody> <tr> <td>wienet Antenne 15815v2</td> <td>F0.000.0036.7</td> </tr> <tr> <td colspan="2">Technical data</td> </tr> <tr> <td>Connector</td> <td>SMA female / SMA male</td> </tr> <tr> <td>Cable</td> <td>Low-loss cable</td> </tr> <tr> <td>Cable length</td> <td>10 m</td> </tr> </tbody> </table>	Type	Part No.	wienet Antenne 15815v2	F0.000.0036.7	Technical data		Connector	SMA female / SMA male	Cable	Low-loss cable	Cable length	10 m												
Type	Part No.																								
wienet Antenne 15815v2	F0.000.0036.7																								
Technical data																									
Connector	SMA female / SMA male																								
Cable	Low-loss cable																								
Cable length	10 m																								

Accessories

Programming adapter MPI-ETH ADAPTER ACCON-NETLINK-PRO

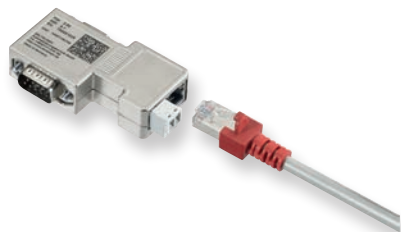

Type	Part No.
MPI-ETH ADAPTER ACCON-NETLINK-PRO	F0.000.0031.8
Technical data	
Supported operating systems	No restriction
Hardware requirements	Ethernet interface and TCP/IP protocol
Supported SPS	S7-200, S7-300, S7-400
Weight in kg	Approx. 0.25
Protection type	IP 20
Operating voltage	24 V DC \pm 25 %
External power supply	Yes
Max. current consumption	150 mA
Electrically isolated	Yes
Operating temperature	0 °C to 60 °C
Storage/transport temperature	-20 °C to 90 °C
Admissible relative air humidity	5 % to 85 % at 30 °C (non-condensing)
Connection cable to the PLC	Permanently mounted, active (no stub line, 1.2 m)
Connection cable to PC/router	Patch cable (Ethernet, straight, 3 m)
Supported bus profiles	MPI, DP, standard, universal (DP/FMS), user-defined, with automatic detection
Supported transmission rates from bus connection to PLC	9.6 Kbit/s to 12 Mbit/s with automatic detection
Supported Ethernet transmission rates	10/100 Mbit/s with automatic detection
Max. number of connections on TCP/IP	16



Switching power supply 12 V for v3 router *wienet PS 12 V v3*



Type	Part No.
<i>wienet PS 12 V v3</i>	F0.000.0037.7
Technical data	
Input voltage	100-240 V AC 50/60 Hz
Output voltage	12 V DC
Output current max.	1000 mA

Switching power supply 12 V for v2 router *wienet PS 12 V v2*



Type	Part No.
<i>wienet PS 12 V v2</i>	F0.000.0037.3
Technical data	
Input voltage	100-240 V AC 50/60 Hz
Output voltage	12 V DC
Output current max.	1000 mA

Pre-assembled 6-pole IO male with wires for v3 router *wienet IO cable v3*



Type	Part No.
<i>wienet IO cable 1 m</i>	F0.000.0037.9
<i>wienet IO cable 3 m</i>	F0.000.0038.0
Technical data	
Cables	CYA 0.5 mm ² (2x white, 2x purple, 2x orange)
Male	WR-MPC4 for v3-router IO interface

M2M device management with own OpenVPN server

Wie-Service24



Open VPN HSDPA
 DynDNS SMS Highspeed Router GPRS
 GSM EDGE HSDPA
 HSPA+ Open VPN HSPA+
 UMTS Ipsec 21,1 Mbit/s
 HSPA+ router

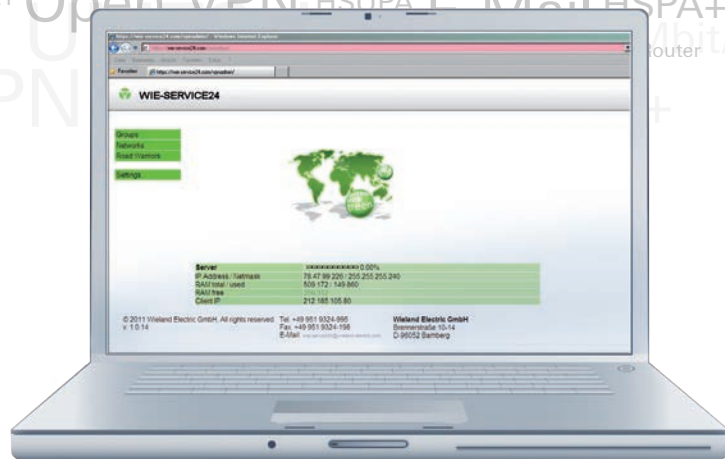

A perfect team

With the **wienet** VPN industrial routers from Wieland and the VPN service portal Wie-Service24, VPN communication in the cloud is child's play. Interlink everything securely and dependably – from individual devices to entire systems – this is the modular router guarantee and the cloud-based management solution Wie-Service24.

Advantages

- Security through VPN
- Automatic generation of router configuration
- Only outgoing connections to Wie-Service24 are needed
- No access to local network required
- Connection of complete networks without additional routing settings
- Less need for coordination with IT and simple commissioning
- Mobile access to all devices after router with smartphone or tablet PC
- directRemote: Direct access to each browser via an explicit URL

Wie-Service24 VPN Service Portal

All systems on the network!

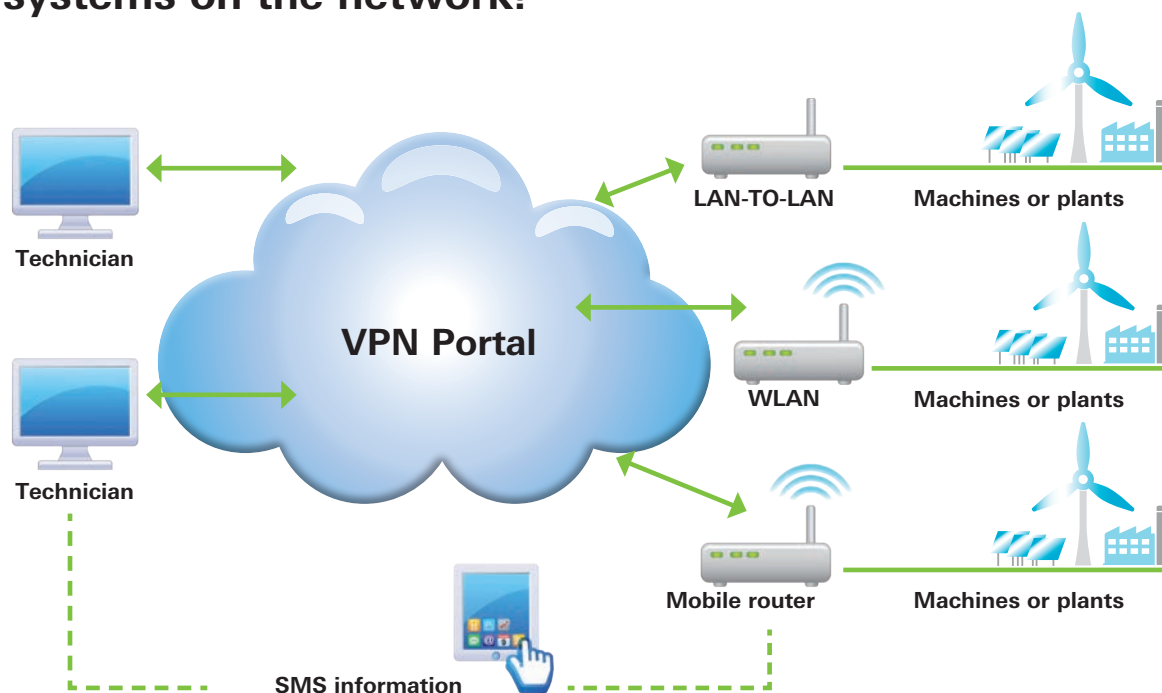

The Wie-Service24 VPN service portal is available in different variants:

The Wieland VPN server Wie-Service24 can be used for entry (up to 30 router clients / 30 PC clients) at no cost. Afterwards, additional accesses on a lease basis or installation of your own server portal are possible. Installation of the portal on virtual machine, in data center in customer RZ or data center on Internet server. The small VPN server "Smart-Service24", delivered completely installed on its own energy-saving hardware, is also suitable for entry to a server portal of your own.

	Starter kit	Single VPN client License	Virtual machine	Data center Customer RZ	Data center Internet server	Small VPN server Smart-Service24
Art.No.	ZD.000.0011.1	ZD.000.0011.0	ZD.000.0012.0	ZD.000.0015.0	ZD.000.0016.0	ZD.000.0017.0
Client access	•	•	•	•	•	•
Name	WIE-SERVICE24 30	WIE-SERVICE24 R	WIE-SERVICE24 VM	WIE-SERVICE24 DC Custom	WIE-SERVICE24 DC Internet	SMART-SERVICE24
Administration access	-	-	•	•	•	•
Server hardware from	Wieland	Wieland	Customer	Customer	Provider	Wieland
Internet connection via	Wieland	Wieland	Customer		Provider	Wieland
Installation by	Wieland	Wieland	Customer or Wieland		Wieland	Wieland (completely installed)
Number of VPN client licenses "PC"	30	1	> 1000	> 1000	> 1000	100
Number of VPN client licenses "Router"	30	1	> 1000	> 1000	> 1000	100
Cost model	No cost	Lease basis	1x fixed price*	1x fixed price*	1x fixed price*	1x fixed price

* Maintenance contract on request



Additional information is available from our Technical Service:

Phone +49 951 9324-995

Fax +49 951 9326-991

wie-service24@wieland-electric.com

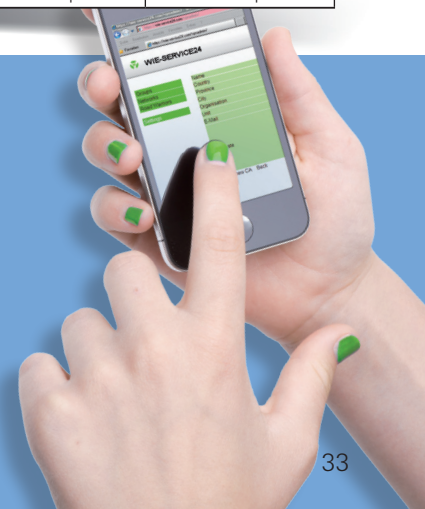

VPN server "Wie-Service24"

The VPN service portal WIE-SERVICE24 ensures the secure connection of your machines and systems. Individual determination of the access rights and encoding of the VPN connections protect your machines and systems. Tedious, error-prone manual router configuration is no longer necessary. Remote access can be accomplished with any Internet-capable PC or smartphone. If the VPN connection happens to break off once, WIE-SERVICE24 reestablishes it.

<h3>VPN licenses</h3> <h4>WIE-SERVICE24</h4> <ul style="list-style-type: none"> • 30 VPN client licenses included for new router clients • Additional VPN client licenses 	<table border="1"> <thead> <tr> <th>Type</th> <th>Part No.</th> </tr> </thead> <tbody> <tr> <td>wienet WIE-SERVICE24-30</td> <td>ZD.000.0011.1</td> </tr> <tr> <td colspan="2">Complete network routing for up to 30 Wieland VPN routers, VPN client accesses for PCs and mobile end-user devices included for new customers.</td> </tr> <tr> <td>wienet WIE-SERVICE24-R</td> <td>ZD.000.0011.0</td> </tr> <tr> <td colspan="2">Individual access to the VPN server portal WIE-SERVICE24 enables complete network routing for a Wieland VPN router; you also receive VPN client accesses for PCs and smartphones at no cost. After the 30 free VPN client licenses are reached, additional licenses can be added at a charge. Invoicing is on an annual basis.</td> </tr> </tbody> </table>	Type	Part No.	wienet WIE-SERVICE24-30	ZD.000.0011.1	Complete network routing for up to 30 Wieland VPN routers, VPN client accesses for PCs and mobile end-user devices included for new customers.		wienet WIE-SERVICE24-R	ZD.000.0011.0	Individual access to the VPN server portal WIE-SERVICE24 enables complete network routing for a Wieland VPN router; you also receive VPN client accesses for PCs and smartphones at no cost. After the 30 free VPN client licenses are reached, additional licenses can be added at a charge. Invoicing is on an annual basis.	
	Type	Part No.									
wienet WIE-SERVICE24-30	ZD.000.0011.1										
Complete network routing for up to 30 Wieland VPN routers, VPN client accesses for PCs and mobile end-user devices included for new customers.											
wienet WIE-SERVICE24-R	ZD.000.0011.0										
Individual access to the VPN server portal WIE-SERVICE24 enables complete network routing for a Wieland VPN router; you also receive VPN client accesses for PCs and smartphones at no cost. After the 30 free VPN client licenses are reached, additional licenses can be added at a charge. Invoicing is on an annual basis.											
	<table border="1"> <thead> <tr> <th colspan="2">Technical data</th> </tr> </thead> <tbody> <tr> <td>30 software single licenses with fixed IP included</td> <td> <ul style="list-style-type: none"> - Client access - No administration access; VPN accesses set up and hosted by Wieland - Server hardware in the industrial data center - Administration via Web interface, SSL and SSH </td> </tr> <tr> <td>Firewall</td> <td> <ul style="list-style-type: none"> - Stateful inspection firewall - Failover mechanism present </td> </tr> <tr> <td>Technical data: VPN server</td> <td> <ul style="list-style-type: none"> - Max. data throughput: Wire speed - Max. number of VPN sessions: 1000 - Number of determined VPN tunnels: 1000 - SSL/TLS - Blowfish encoding - Authentication: PKI </td> </tr> </tbody> </table>	Technical data		30 software single licenses with fixed IP included	<ul style="list-style-type: none"> - Client access - No administration access; VPN accesses set up and hosted by Wieland - Server hardware in the industrial data center - Administration via Web interface, SSL and SSH 	Firewall	<ul style="list-style-type: none"> - Stateful inspection firewall - Failover mechanism present 	Technical data: VPN server	<ul style="list-style-type: none"> - Max. data throughput: Wire speed - Max. number of VPN sessions: 1000 - Number of determined VPN tunnels: 1000 - SSL/TLS - Blowfish encoding - Authentication: PKI 		
Technical data											
30 software single licenses with fixed IP included	<ul style="list-style-type: none"> - Client access - No administration access; VPN accesses set up and hosted by Wieland - Server hardware in the industrial data center - Administration via Web interface, SSL and SSH 										
Firewall	<ul style="list-style-type: none"> - Stateful inspection firewall - Failover mechanism present 										
Technical data: VPN server	<ul style="list-style-type: none"> - Max. data throughput: Wire speed - Max. number of VPN sessions: 1000 - Number of determined VPN tunnels: 1000 - SSL/TLS - Blowfish encoding - Authentication: PKI 										

<h3>VPN service portal</h3> <h4>WIE-SERVICE24</h4> <h4>full server license</h4> <ul style="list-style-type: none"> • Virtual machine • Customer server • Internet data center 	<table border="1"> <thead> <tr> <th>Type</th> <th>Part No.</th> </tr> </thead> <tbody> <tr> <td>wienet WIE-SERVICE24-VM</td> <td>ZD.000.0012.0</td> </tr> <tr> <td colspan="2">As a virtual machine for the Oracle VirtualBox, the VPN service portal WIE-SERVICE24 enables full network routing for almost any number of Wieland VPN routers. Additional virtualization environments can be established by installation from a CD. The operating system Debian GNU/Linux is a component of the installation CD/DVD.</td> </tr> <tr> <td>wienet WIE-SERVICE24-DC-Custom</td> <td>ZD.000.0015.0</td> </tr> <tr> <td colspan="2">The VPN service portal WIE-SERVICE24, installed ready-to-operate in your data center, enables full network routing for any number of Wieland VPN routers. You can set up and manage as many VPN client accesses as you want, on your own. The client configurations are automatically generated from the VPN service portal.</td> </tr> <tr> <td>wienet WIE-SERVICE24-DC-Intern.</td> <td>ZD.000.0016.0</td> </tr> <tr> <td colspan="2">The VPN service portal WIE-SERVICE24 in the Internet data center- our Top Seller! Installed ready-to-operate at your Internet service provider, enables full network routing for any number of Wieland VPN routers. You can set up and manage as many VPN client accesses as you want, on your own. The client configurations are automatically generated from the VPN service portal.</td> </tr> </tbody> </table>	Type	Part No.	wienet WIE-SERVICE24-VM	ZD.000.0012.0	As a virtual machine for the Oracle VirtualBox, the VPN service portal WIE-SERVICE24 enables full network routing for almost any number of Wieland VPN routers. Additional virtualization environments can be established by installation from a CD. The operating system Debian GNU/Linux is a component of the installation CD/DVD.		wienet WIE-SERVICE24-DC-Custom	ZD.000.0015.0	The VPN service portal WIE-SERVICE24, installed ready-to-operate in your data center, enables full network routing for any number of Wieland VPN routers. You can set up and manage as many VPN client accesses as you want, on your own. The client configurations are automatically generated from the VPN service portal.		wienet WIE-SERVICE24-DC-Intern.	ZD.000.0016.0	The VPN service portal WIE-SERVICE24 in the Internet data center- our Top Seller! Installed ready-to-operate at your Internet service provider, enables full network routing for any number of Wieland VPN routers. You can set up and manage as many VPN client accesses as you want, on your own. The client configurations are automatically generated from the VPN service portal.	
	Type	Part No.													
wienet WIE-SERVICE24-VM	ZD.000.0012.0														
As a virtual machine for the Oracle VirtualBox, the VPN service portal WIE-SERVICE24 enables full network routing for almost any number of Wieland VPN routers. Additional virtualization environments can be established by installation from a CD. The operating system Debian GNU/Linux is a component of the installation CD/DVD.															
wienet WIE-SERVICE24-DC-Custom	ZD.000.0015.0														
The VPN service portal WIE-SERVICE24, installed ready-to-operate in your data center, enables full network routing for any number of Wieland VPN routers. You can set up and manage as many VPN client accesses as you want, on your own. The client configurations are automatically generated from the VPN service portal.															
wienet WIE-SERVICE24-DC-Intern.	ZD.000.0016.0														
The VPN service portal WIE-SERVICE24 in the Internet data center- our Top Seller! Installed ready-to-operate at your Internet service provider, enables full network routing for any number of Wieland VPN routers. You can set up and manage as many VPN client accesses as you want, on your own. The client configurations are automatically generated from the VPN service portal.															
	<table border="1"> <thead> <tr> <th colspan="2">Technical data</th> </tr> </thead> <tbody> <tr> <td>VPN server portal: <ul style="list-style-type: none"> - On virtual machine - For Oracle VirtualBox - On server at customer's - On server at Internet service provider </td> <td> <ul style="list-style-type: none"> - Administration and client access - Server hardware and Internet connection by customer - Installation by customer or Wieland partner - Administration via Web interface, SSL and SSH </td> </tr> <tr> <td>Firewall</td> <td> <ul style="list-style-type: none"> - Stateful inspection firewall - Failover mechanism present </td> </tr> <tr> <td>VPN</td> <td> <ul style="list-style-type: none"> - Max. data throughput: Wire speed - Max. number of simultaneous VPN sessions: 1000 - Number of determined VPN tunnels: 1000 - SSL/TLS - Blowfish encoding - Authentication: PKI </td> </tr> <tr> <td>Service</td> <td> <ul style="list-style-type: none"> - Four weeks of telephone installation support - 12 months of update service </td> </tr> </tbody> </table>	Technical data		VPN server portal: <ul style="list-style-type: none"> - On virtual machine - For Oracle VirtualBox - On server at customer's - On server at Internet service provider 	<ul style="list-style-type: none"> - Administration and client access - Server hardware and Internet connection by customer - Installation by customer or Wieland partner - Administration via Web interface, SSL and SSH 	Firewall	<ul style="list-style-type: none"> - Stateful inspection firewall - Failover mechanism present 	VPN	<ul style="list-style-type: none"> - Max. data throughput: Wire speed - Max. number of simultaneous VPN sessions: 1000 - Number of determined VPN tunnels: 1000 - SSL/TLS - Blowfish encoding - Authentication: PKI 	Service	<ul style="list-style-type: none"> - Four weeks of telephone installation support - 12 months of update service 				
Technical data															
VPN server portal: <ul style="list-style-type: none"> - On virtual machine - For Oracle VirtualBox - On server at customer's - On server at Internet service provider 	<ul style="list-style-type: none"> - Administration and client access - Server hardware and Internet connection by customer - Installation by customer or Wieland partner - Administration via Web interface, SSL and SSH 														
Firewall	<ul style="list-style-type: none"> - Stateful inspection firewall - Failover mechanism present 														
VPN	<ul style="list-style-type: none"> - Max. data throughput: Wire speed - Max. number of simultaneous VPN sessions: 1000 - Number of determined VPN tunnels: 1000 - SSL/TLS - Blowfish encoding - Authentication: PKI 														
Service	<ul style="list-style-type: none"> - Four weeks of telephone installation support - 12 months of update service 														

VPN server "Smartservice24"

The compact VPN server SMARTSERVICE24 enables your easy entry to a VPN infrastructure of your own. It ensures the secure connection of your machines and systems: You are protected by individual determination of access rights and encoding of VPN connections. You set up the authorization management in seconds, individually for each device. Tedious, error-prone manual router configuration is no longer necessary. Remote access can be accomplished with any Internet-capable PC or smartphone. If the VPN connection happens to break off once, the Digicluster reestablishes it independently.

Compact VPN server SMARTSERVICE24	Type	Part No.
	wienet SMARTSERVICE24	ZD.000.0017.0
	Features	
	The compact VPN server SMARTSERVICE24, installed ready-to-operate on a small, energy-saving hardware unit, enables full network routing for up to 100 Wieland VPN routers. Also, up to 100 VPN client accesses for PCs and smartphones can be set up and managed. The client configurations are automatically generated from the VPN service portal.	
	Technical data	
	Software installed ready-to-operate on environmentally-friendly embedded hardware.	<ul style="list-style-type: none"> - Limited to 100 VPN tunnels - Administration and client access - Server hardware from Wieland - Internet connection by customer - Administration via Web interface, SSL and SSH
Firewall	<ul style="list-style-type: none"> - Stateful inspection firewall - Failover mechanism present 	
VPN	<ul style="list-style-type: none"> - Max. data throughput: Wire speed - Max. number of VPN sessions: 100 - Number of determined VPN tunnels: 100 - SSL/TLS - Blowfish encoding - Authentication: PKI 	
Service	<ul style="list-style-type: none"> - One-time feature update - 12 months of update service 	



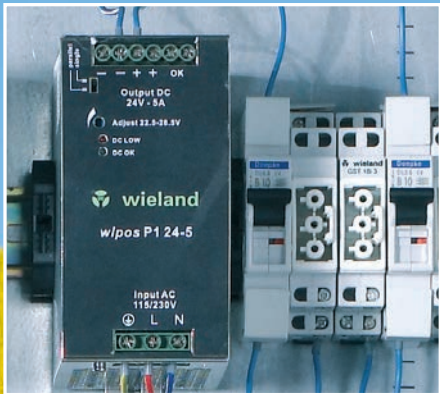











wipos Power supply units

Pure Power. No-Frills.

Power supplies perform a central function in the control cabinet. Their reliability affects the availability of the machine or the process to a great degree. That is why a robust and proven design is very important for a power supply unit. There are no unnecessary frills with the **wipos** family. Instead, these power supply units score with their fundamental features.

wipos satisfies your requirements in the significant disciplines:

 100% power up to 60°C	 Can be connected in parallel (from 5 A) to increase power and redundancy
 Automatic or wide-input voltage range for worldwide use	 High operational reliability due to long hold-up times >30 ms
 PFC-technology for high functional reliability	 Compensation of voltage drops via adjustable output voltage
 Outdoor installation possible due to wide temperature range	 Easy to commission via LED diagnosis
 Active monitoring with signalling contact P1/3	 For mounting on DIN Rail TS 35 / TS 32

Additional features of **wipos** PS1/3

- Durable in harsh environments
- Compact design
- 120% power boost for 10 s
- Full output during 2-phase operation
- Lloyds Register Ship Approval (LR)



wipos P1 Modules

Power supply wipos
P1 24-1.25
P1 24-2.5



Type	Part No.	Part No.
wipos P1 24-1.25	81.000.6110.0	
wipos P1 24-2.5		81.000.6120.0
Technical Data		
Input voltage	85 – 264 V AC, 90 – 375 V DC	
PFC	not necessary	not necessary
Hold up time	> 30 ms at 230 V	> 30 ms at 230 V
Output voltage	24 – 28 V	24 – 28 V
Output current	1.25 A	2.5 A
Parallel operation	no	no
In series connectable	yes	yes
Temperature range	-40 ... +70 °C	-40 ... +70 °C
Derating	> 60 °C	> 60 °C
Signal contact	yes	yes
Dimensions (mm) W x H x D	40.5 x 90 x 114	40.5 x 90 x 114
Weight	290 g	360 g
Type of connectors	Screw terminal	Screw terminal
Connector size	0.2 – 2.5 mm ² (AWG 24 – 14)	0.2 – 2.5 mm ² (AWG 24 – 14)
Efficiency	83 – 86 %	86 – 89 %
Approvals	CE UL 1310 Class 2 HAZ. Class I Div.2	CE UL 1310 Class 2 HAZ. Class I Div.2

Power supply wipos
P1 24-3.8
P1 24-5



Type	Part No.	Part No.
wipos P1 24-3.8	81.000.6135.0	
wipos P1 24-5		81.000.6130.0
Technical Data		
Input voltage	115/230V AC auto, 210 – 375V DC	
PFC	yes	yes
Hold up time	> 30 ms at 230 V	> 30 ms at 230 V
Output voltage	22.5 – 28 V	22.5 – 28.5 V
Output current	3.8 A	5 A
Parallel operation	no	yes (up to 3)
In series connectable	yes	yes
Temperature range	-35 ... +70 °C	-35 ... +70 °C
Derating	> 60 °C	> 60 °C
Signal contact	yes	yes
Dimensions (mm) W x H x D	64 x 124.5 x 123.6	64 x 124.5 x 123.6
Weight	920 g	920 g
Type of connectors	Screw terminal	Screw terminal
Connector size	0.5 – 6 mm ² (AWG 22 – 10)	0.5 – 6 mm ² (AWG 22 – 10)
Efficiency	83 – 85 %	84 – 86 %
Approvals	CE UL 1310 Class 2 HAZ. Class I Div.2	CE HAZ. Class I Div.2

Power supply wipos
P1 24-10
P1 24-20



Type	Part No.	Part No.
wipos P1 24-10	81.000.6140.0	
wipos P1 24-20		81.000.6150.0
Technical Data		
Input voltage	115/230V AC auto, 210–375V DC	115/230V AC auto 120–370V DC
PFC	yes	yes
Hold up time	> 30 ms at 230 V	> 30 ms at 230 V
Output voltage	22.5 – 28.5 V	22.5 – 28.5 V
Output current	10 A	20 A
Parallel operation	yes (up to 3)	yes (up to 3)
In series connectable	yes	yes
Temperature range	-40 ... +70 °C	-40 ... +70 °C
Derating	> 60 °C	> 55 °C
Signal contact	yes	yes
Dimensions (mm) W x H x D	83.5 x 124.5 x 123.6	175.5 x 124.5 x 123.6
Weight	1300 g	1920 g
Type of connectors	Screw terminal	Screw terminal
Connector size	0.5 – 6 mm ² (AWG 22 – 10)	0.5 – 6 mm ² (AWG 22 – 10)
Efficiency	87 – 89 %	86 – 89 %
Approvals	CE HAZ. Class I Div.2	CE HAZ. Class I Div.2

wipos P1 Modules

Power supply *wipos* P1 12-5



Type	Part No.
wipos P1 12-5	81.000.6132.0
Technical Data	
Input voltage	85 – 264 V AC, 90 – 375 V DC
PFC	not necessary
Hold up time	>30 ms at 230 V
Output voltage	12 – 14 V
Output current	5 A
Parallel operation	no
In series connectable	yes
Temperature range	-40 ... +70 °C
Derating	>61 °C
Signal contact	no
Dimensions (mm) W x H x D	40,5 x 90 x 114
Weight	340 g
Type of connectors	Screw terminal
Connector size	0.2 – 2.5 mm ² (AWG 24 – 14)
Efficiency	86 %
Approvals	CE HAZ. Class I Div.2

Power supply *wipos* P1 12-10



Type	Part No.
wipos P1 12-10	81.000.6142.0
Technical Data	
Input voltage	115/230V AC auto, 210 – 375 V DC
PFC	not necessary
Hold up time	>30 ms at 230 V
Output voltage	11,4 – 14,5 V
Output current	10 A
Parallel operation	yes (up to 3)
In series connectable	yes
Temperature range	-35 ... +70 °C
Derating	>61 °C
Signal contact	no
Dimensions (mm) W x H x D	64 x 124.5 x 123.6
Weight	920 g
Type of connectors	Screw terminal
Connector size	0.5 – 6 mm ² (AWG 22 – 10)
Efficiency	84 %
Approvals	CE HAZ. Class I Div.2

Power supply *wipos* P1 48-5



Type	Part No.
wipos P1 48-5	81.000.6134.0
Technical Data	
Input voltage	115/230 V AC auto, 210 – 375 V DC
PFC	not necessary
Hold up time	>30 ms at 230 V
Output voltage	47 – 56 V
Output current	5 A
Parallel operation	yes (up to 3)
In series connectable	yes
Temperature range	-40 ... +70 °C
Derating	>61 °C
Signal contact	no
Dimensions (mm) W x H x D	83,5 x 124,5 x 123,6
Weight	1380 g
Type of connectors	Screw terminal
Connector size	0.5 – 6 mm ² solid/fine str. (AWG 22 – 10)
Efficiency	90 %
Approvals	CE HAZ. Class I Div.2

wipos P3 Modules

Power supply *wipos* P3 24-5 P3 24-10



Type	Part No.	Part No.
wipos P3 24-5	81.000.6160.0	
wipos P3 24-10		81.000.6170.0
Technical Data		
Input voltage	340 – 575 VAC 480 – 820 VDC	340 – 575 VAC 480 – 820 VDC
PFC	yes (0.55)	yes (0.6)
Hold up time	20 ms	20 ms
Output voltage	22.5 – 28.5 V	22.5 – 28.5 V
Output current	5 A	10 A
Parallel operation	yes (up to 2)	yes (up to 2)
In series connectable	yes	yes
Temperature range	-40 ... +70 °C	-40 ... +70 °C
Derating	>60 °C	>60 °C
Signal contact	yes	yes
Dimensions (mm) W x H x D	75 x 124 x 119	89 x 124 x 119
Weight	800 g	1100 g
Type of connectors	Screw terminal	Screw terminal
Connector size	to 6 mm ² (AWG 10)	to 6 mm ² (AWG 10)
Efficiency	88 – 90 %	88 – 90 %
Approvals	CE, UL, HAZ, IEC Class I Div.2	CE, UL, HAZ, IEC Class I Div.2

Power supply *wipos* P3 24-20



Type	Part No.
wipos P3 24-20	81.000.6180.0
Technical Data	
Input voltage	340 – 575 VAC 480 – 820 VDC
PFC	yes (0.7)
Hold up time	20 ms
Output voltage	22.5 – 28.5 V
Output current	20 A
Parallel operation	yes (up to 2)
In series connectable	yes
Temperature range	-30 ... +70 °C
Derating	>60 °C
Signal contact	yes
Dimensions (mm) W x H x D	150 x 124 x 119
Weight	1750 g
Type of connectors	Screw terminal
Connector size	to 6 mm ² (AWG 10)
Efficiency	88 – 90 %
Approvals	CE, UL, HAZ, IEC Class I Div.2

Power supply *wipos* P3 24-40



Type	Part No.
wipos P3 24-40	81.000.6190.0
Technical Data	
Input voltage	340 – 575 VAC 480 – 820 VDC
PFC	yes (0.7)
Hold up time	15 ms
Output voltage	22.5 – 28.5 V
Output current	40 A
Parallel operation	yes (up to 2)
In series connectable	yes
Temperature range	-40 ... +70 °C
Derating	>60 °C
Signal contact	yes
Dimensions (mm) W x H x D	276 x 127 x 119
Weight	3200 g
Type of connectors	Screw terminal
Connector size	to 6 mm ² (AWG 10)/ output to 16 mm ² (AWG 6)
Efficiency	90 – 92 %
Approvals	CE, UL, HAZ, IEC Class I Div.2

wipos Modules

Redundancy module *wipos* R20



Type	Part No.
wipos R20	81.000.6200.0
Technical Data	
Input voltage	21 – 28 V DC
Input current	20 A (in total)
Output current	20 A
Typical voltage drop	0.5 V
Temperature range	-40 ... +70 °C
Signal contact	one each for channel A and B
Signal contact	1 A at 30 V DC
Display/Relay OK	Input voltage 20...30 V (+/-5 %)
Display/Relay fail	Input voltage <20 V or >30 V (+/-5 %)
Dimensions (mm) W x H x D	54 x 90 x 114
Weight	210 g
Type of connectors	Screw terminal
Connector size	0.2 – 2.5 mm ² (AWG 24–12)
Connector size for signal contacts	0.2 – 1.5 mm ² (AWG 24–14)
Approvals	CE

Fusing module *wipos* FM 4-10



Type	Part No.
wipos FM 4-10	81.000.6210.0
Technical Data	
Input voltage	18 – 30 V
Output current via all 4 fuses	40 A max.
Output voltage	24 V (equivalent to input voltage)
Number of fusing circuits	4
Nominal current of fuse	max. 10 A (check power losses of fuse)
Fuses	4 x G-fuse holder 5 x 20 mm
LED	one per fuse, LED lights whe fuse is broken
Alarm contact	yes
Temperature range	0 ... +60 °C
Dimensions (mm) W x H x D	48 x 96 x 68
Mounting type	DIN rail mounting
Weight	110 g
Type of connectors	Screw terminal
Connector size input	10 mm ² (AWG 8)
Connector size output	up to 4 mm ² (AWG 12) solid, 2.5 mm ² (AWG 14) fine-stranded
Approvals	CE

Uninterrupted power supply *wipos* UPS 24-30



Type	Part No.
wipos UPS 24-30	81.000.6220.0
Technical Data	
Rated input voltage U _{IN}	24 V DC
Input current	max. 35 A
Rated output voltage U _{OUT}	24 V DC
Output current I _{OUT}	max. 30 A
Output voltage (battery mode)	18.7 – 28.0 V
Output current (battery mode)	max. 30 A
Temperature range	-40 ... +70 °C
Derating	> 51 °C
Signal contact mains or battery current	yes
Signal contact discharge battery	yes
Signal contact broken battery	yes
Battery type	Lead-acid or lead-gel
Battery size	2 ... 12 Ah / 2 x 12 V
Dimensions (mm) W x H x D	54 x 90 x 114
Weight	370 g
Type of connectors	Screw terminal
Connector size	0.2–4 mm ² (AWG 24–12)
Approvals	CE



wipos PS1 Modules in compact design

Power supply wipos
PS1 24-1.25
PS1 24-2.5



Type	Part No.	Part No.
wipos PS1 24-1.25	81.000.6510.0	
wipos PS1 24-2.5		81.000.6520.0
Technical Data		
Input voltage	85 – 264 V AC, 90 – 350 V DC	
PFC	–	–
Hold up time	> 154 ms bei 230 V	> 129 ms bei 230 V
Output voltage	21.6 - 27.6	21.6 - 27.6
Output current	1.25 A (Power Boost 120 %)	2.5 A (Power Boost 120 %)
Parallel operation	yes	yes
In series connectable	yes	yes
Temperature range	-40 ... +70 °C	-40 ... +70 °C
Derating	> 60 °C	> 60 °C
Dimensions (mm) W x H x D	32 x 90 x 90	32 x 90 x 110
Weight	195 g	260 g
Type of connectors	Screw terminal	Screw terminal
Connector size Input	0.25 – 2.5 mm ² (AWG 24 – 14)	0.35 – 2.5 mm ² (AWG 22 – 14)
Connector size Output	0.35 – 2.5 mm ² (AWG 22 – 14)	0.5 – 2.5 mm ² (AWG 22 – 14)
Efficiency	86%	88%
Approvals	CE HAZ.LOC.	CE HAZ.LOC.

Power supply wipos
PS1 24-5



Type	Part No.	Part No.
wipos PS1 24-5	81.000.6530.0	
Technical Data		
Input voltage	85 – 264 V AC, 90 – 350 V DC	
PFC	yes	
Hold up time	> 42 ms at 230 V	
Output voltage	21.6 - 27.6	
Output current	5 A (Power Boost 120 %)	
Parallel operation	yes	
In series connectable	yes	
Temperature range	-40 ... +70 °C	
Derating	> 60 °C	
Dimensions (mm) W x H x D	40 x 125 x 122.2	
Weight	620 g	
Type of connectors	Screw terminal	
Connector size Input	0.35 – 4 mm ² (AWG 22 – 12)	
Connector size Output	0.35 – 4 mm ² (AWG 22 – 12)	
Efficiency	89%	
Approvals	CE HAZ.LOC.	

Power supply wipos
PS1 24-10
PS1 24-20



Type	Part No.	Part No.
wipos PS1 24-10	81.000.6540.0	
wipos PS1 24-20		81.000.6550.0
Technical Data		
Input voltage	85 – 264 V AC, 90 – 350 V DC	
PFC	ja	ja
Hold up time	> 44 ms at 230 V	> 50 ms at 230 V
Output voltage	21.6 - 27.6	21.6 - 27.6
Output current	10 A (Power Boost 120 %)	20 A (Power Boost 120 %)
Parallel operation	yes	yes
In series connectable	yes	yes
Temperature range	-40 ... +70 °C	-40 ... +70 °C
Derating	> 60 °C	> 60 °C
Dimensions (mm) W x H x D	60 x 125 x 150	95 x 125 x 150
Weight	900 g	1500 g
Type of connectors	Screw terminal	Screw terminal
Connector size Input	0.5 – 4 mm ² (AWG 22 – 12)	1.5 – 4 mm ² (AWG 16 – 12)
Connector size Output	2.5 – 4 mm ² (AWG 14 – 12)	4 mm ² (AWG 12)
Efficiency	92%	93%
Approvals	CE HAZ.LOC.	CE

Special voltages on demand
Connector size fine stranded

wipos PS3 Modules in compact design

Power supply *wipos* PS3 24-5 PS3 24-10



Type	Part No.	Part No.
wipos PS3 24-5	81.000.6560.0	
wipos PS3 24-10		81.000.6570.0
Technical Data		
Input voltage	320 – 576 V AC, 450 – 810 V DC	
PFC	–	
Hold up time	> 30 ms at 400 V	> 20 ms at 400 V
Output voltage	22.5 -29.5	
Output current	5 A (Power Boost 6A)	10 A (Power Boost 12A)
Parallel operation	yes	
In series connectable	yes	
Temperature range	-40 ... +70 °C	
Derating	> 60 °C	
Dimensions (mm) W x H x D	40 x 125 x 122.2	60 x 125 x 150
Weight	700 g	1000 g
Type of connectors	Screw terminal	
Connector size Input	0.35 – 4 mm ² (AWG 22 – 12)	0.35 – 4 mm ² (AWG 22 – 12)
Connector size Output	0.75 – 4 mm ² (AWG 18 – 12)	2.5 – 4 mm ² (AWG 14 – 12)
Efficiency	89%	
Approvals	CE HAZ.LOC.	CE HAZ.LOC.

Power supply *wipos* PS3 24-20



Type	Part No.
wipos PS3 24-20	81.000.6580.0
Technical Data	
Input voltage	320 – 576 V AC, 450 – 810 V DC
PFC	–
Hold up time	> 20 ms at 400 V
Output voltage	22.5 -29.5
Output current	20 A (Power Boost 24A)
Parallel operation	yes
In series connectable	yes
Temperature range	-40 ... +70 °C
Derating	> 60 °C
Dimensions (mm) W x H x D	95 x 125 x 150
Weight	1600 g
Type of connectors	Screw terminal
Connector size Input	0.5 – 4 mm ² (AWG 20 – 12)
Connector size Output	4 mm ² (AWG 12)
Efficiency	91%
Approvals	CE HAZ.LOC.

Power supply *wipos* PS3 24-40



Type	Part No.
wipos PS3 24-40	81.000.6590.0
Technical Data	
Input voltage	320 – 576 V AC
PFC	–
Hold up time	> 20 ms at 400 V
Output voltage	22.5 -29.5
Output current	40 A (Power Boost 48A)
Parallel operation	yes
In series connectable	yes
Temperature range	-40 ... +70 °C
Derating	> 60 °C
Dimensions (mm) W x H x D	135 x 125 x 180
Weight	2700 g
Type of connectors	Screw terminal
Connector size Input	1.5 – 16 mm ² (AWG 16 – 6)
Connector size Output	10 - 16 mm ² (AWG 8 - 6)
Efficiency	91%
Approvals	CE HAZ.LOC.



wipos PB1 Modules

Power supply wipos PB1 5-1.5 PB1 5-3



Type	Part No.	Part No.
wipos PB1 5-1.5	81.000.6321.0	
wipos PB1 5-3		81.000.6331.0
Technical Data		
Input voltage	90 – 264 V AC, 120 – 375 V DC	90 – 264 V AC, 120 – 375 V DC
PFC	not necessary	not necessary
Hold up time	> 30 ms at 230 V	> 80 ms at 230 V
Output voltage	5 V	5 – 5.5 V
Output current	1.5 A	3 A
Temperature range	-40 ... +70 °C	-40 ... +70 °C
Derating	> 61 °C	> 61 °C
LED display	yes	yes
Dimensions W x H x D	18 x 91 x 57	35 x 91 x 57
Installation dimensions	for junction boxes and flat control panels	for junction boxes and flat control panels
Mounting type	DIN rail mounting	DIN rail mounting
Weight	65 g	130 g
Type of connectors	Screw terminal	Screw terminal
Connector size	0.2 – 2.5 mm ² (AWG 24–14)	0.2 – 2.5 mm ² (AWG 24–14)
Efficiency	74 %	82 %
Approvals	CE UL 1310 Class 2 Haz. Class I Div.2	CE UL 1310 Class 2

Power supply wipos PB1 12-0.83 PB1 24-0.42



Type	Part No.	Part No.
wipos PB1 12-0.83	81.000.6302.0	
wipos PB1 24-0.42		81.000.6300.0
Technical Data		
Input voltage	90 – 264 V AC, 120 – 375 V DC	90 – 264 V AC, 120 – 375 V DC
PFC	not necessary	not necessary
Hold up time	> 30 ms at 230 V	> 30 ms at 230 V
Output voltage	12 V	24 – 28 V
Output current	0.83 A	0.42 A
Temperature range	-40 ... +70 °C	-25 ... +70 °C
Derating	> 61 °C: 100 %, 70 °C: 75 %	> 60 °C
LED display	yes	yes
Dimensions W x H x D	18 x 91 x 57	18 x 91 x 57
Installation dimensions	for junction boxes and flat control panels	for junction boxes and flat control panels
Mounting type	DIN rail mounting	DIN rail mounting
Weight	65 g	65 g
Type of connectors	Screw terminal	Screw terminal
Connector size	0.2 – 2.5 mm ² (AWG 24–14)	0.2 – 2.5 mm ² (AWG 24–14)
Efficiency	78 %	80 %
Approvals	CE Haz. Class I Div.2	CE UL 1310 Class 2 Haz. Class I Div.2

Power supply wipos PB1 12-2 PB1 24-1



Type	Part No.	Part No.
wipos PB1 12-2	81.000.6322.0	
wipos PB1 24-1		81.000.6310.0
Technical Data		
Input voltage	90 – 264 V AC, 120 – 375 V DC	90 – 264 V AC, 120 – 375 V DC
PFC	not necessary	not necessary
Hold up time	> 80 ms at 230 V	> 80 ms at 230 V
Output voltage	12 – 14 V	24 – 28 V
Output current	2 A	1 A
Temperature range	-40 ... +70 °C	-25 ... +70 °C
Derating	> 61 °C: 100 %, 70 °C: 75 %	> 60 °C
LED display	yes	yes
Dimensions W x H x D	35 x 91 x 57	35 x 91 x 57
Installation dimensions	for junction boxes and flat control panels	for junction boxes and flat control panels
Mounting type	DIN rail mounting	DIN rail mounting
Weight	130 g	130 g
Type of connectors	Screw terminal	Screw terminal
Connector size	0.2 – 2.5 mm ² (AWG 24–14)	0.2 – 2.5 mm ² (AWG 24–14)
Efficiency	84 %	85 %
Approvals		
	CE UL 1310 Class 2	CE UL 1310 Class 2

wipos PB1 Modules

Power supply *wipos* PB1 12-2.75 PB1 24-1.5



Type	Part No.	Part No.
wipos PB1 12-2.75	81.000.6332.0	
wipos PB1 24-1.5		81.000.6320.0
Technical Data		
Input voltage	90 – 264 V AC, 120 – 375 V DC	90 – 264 V AC, 120 – 375 V DC
PFC	not necessary	not necessary
Hold up time	> 60 ms at 230 V	> 100 ms at 230 V
Output voltage	12 – 14 V	24 – 28 V
Output current	2.75 A	1.5 A
Temperature range	-40 ... +70 °C	-25 ... +70 °C
Derating	> 56 °C	> 56 °C
LED display	yes	yes
Dimensions (mm) W x H x D	53 x 91 x 57	53 x 91 x 57
Installation dimensions	for junction boxes and flat control panels	for junction boxes and flat control panels
Mounting type	DIN rail mounting	DIN rail mounting
Weight	250 g	190 g
Type of connectors	Screw terminal	Screw terminal
Connector size	0.2 – 2.5 mm ² (AWG 24–14)	0.2 – 2.5 mm ² (AWG 24–14)
Efficiency	84 %	84 %
Approvals	CE UL 1310 Class 2	CE UL 1310 Class 2

Power supply *wipos* PB1 12-4.5 PB1 24-2.5



Type	Part No.	Part No.
wipos PB1 12-4.5	81.000.6342.0	
wipos PB1 24-2.5		81.000.6330.0
Technical Data		
Input voltage	90 – 264 V AC, 120 – 375 V DC	90 – 264 V AC, 120 – 375 V DC
PFC	not necessary	not necessary
Hold up time	> 60 ms at 230 V	> 60 ms at 230 V
Output voltage	12 – 14 V	24 – 28 V
Output current	4.5 A	2.5 A
Temperature range	-40 ... +70 °C	-25 ... +70 °C
Derating	> 56 °C	> 60 °C
LED display	ja	yes
Dimensions (mm) W x H x D	71 x 91 x 57	71 x 91 x 57
Installation dimensions	for junction boxes and flat control panels	for junction boxes and flat control panels
Mounting type	DIN rail mounting	DIN rail mounting and screw connection
Weight	250 g	250 g
Type of connectors	Screw terminal	Screw terminal
Connector size	0.2 – 2.5 mm ² (AWG 24–14)	0.2 – 2.5 mm ² (AWG 24–14)
Efficiency	84 %	86 %
Approvals	CE UL 1310 Class 2 Haz. Class I Div.2	CE UL 1310 Class 2 Haz. Class I Div.2

Power supply *wipos* PB1 24-4.2



Type	Part No.
wipos PB1 24-4.2	81.000.6340.0
Technical Data	
Input voltage	90 – 264 V AC, 120 – 375 V DC
PFC	not necessary
Hold up time	> 60 ms at 230 V
Output voltage	24 – 28 V
Output current	4.2 A
Temperature range	-40 ... +70 °C
Derating	> 60 °C
LED display	yes
Dimensions (mm) W x H x D	90 x 91 x 57
Installation dimensions	for junction boxes and flat control panels
Mounting type	DIN rail mounting and screw connection
Weight	380 g
Type of connectors	Screw terminal
Connector size	0.2 – 2.5 mm ² (AWG 24–14)
Efficiency	89 %
Approvals	CE Haz. Class I Div.2



Coupling relays

The safe way to achieve a perfect interface in process applications.

In the microchip age of bits and bytes, one might assume that there is no place left for electro-mechanical relays. Far from it!

In control, transportation and production technology, coupling relays have been reliably accomplishing important tasks for years, and continue to do so.

Together with control systems, they offer numerous possibilities of making your application even safer and less sensitive to disturbances.







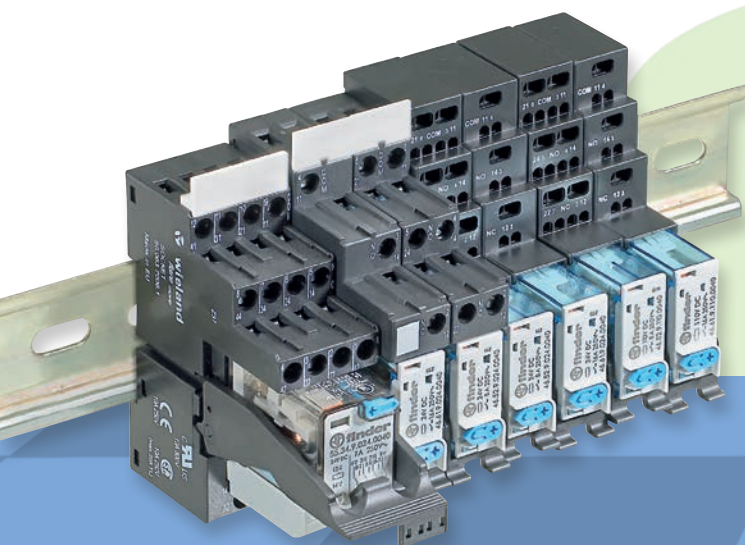

Advantages:

- Safe galvanic separation
- Pluggable and compact solutions
- Mounts directly onto a 35-mm DIN rail
- Optional gold-plated contacts
- Screw clamp and tension spring termination
- Display and EMI suppression modules
- Also suitable for railway applications acc. to EN 50155



Coupling relays

flare MOVE	Description		Part No.	Std. Pack	Part No.	Std. Pack	
	<ul style="list-style-type: none"> • Pluggable coupling relay • Overall width 6.2 mm • Screw terminals • 1 change-over contact 6A 	flare MOVE		AgSnO₂		AgSnO₂ + gold (5μ)	
12V Relay module DC		80.010.4501.0	10	80.010.4501.1	10		
12V Relay module AC/DC		80.010.4521.0	10	80.010.4521.1	10		
24V Relay module DC		80.010.4502.0	10	80.010.4502.1	10		
24V Relay module AC/DC spring clamp con.		80.010.4622.0	10				
24V Relay module AC/DC		80.010.4522.0	10	80.010.4522.1	10		
115V Relay module AC/DC		80.010.4525.0	10	80.010.4525.1	10		
230V Relay module AC/DC		80.010.4526.0	10	80.010.4526.1	10		
Comb-shaped jumper 20pol. max 36A		80.063.4029.1	10				
Marking plate BM SF38		80.063.4129.3	1				
Replacement relay and socket		Information on request					
Technical data							
Maximum switching voltage		400 V AC					
Maximum switching current		6 A AC/DC					
Maximum starting current		10 A					
Mechanical life		1 x 10 ⁷					
Electrical life up to 230 V AC / 6A		6 x 10 ⁴					
Isolation voltage of input / output		4 kV eff					
Connectable via pluggable jumper		20 modules					
Wire range fine-stranded/solid		0.14 - 1.5 mm ² (AWG 26–16) / 0.5 - 2.5 mm ² (AWG 22–14)					
Degree of protection / Mounting rail		IP 20 / TS35					
Dimensions (mm) W x H x D		6.2 x 88 x 76					
Ambient temperature		0 ... +50 °C					
Approvals		CE  					

flare MOVE	Description		Part No.	Std. Pack	Part No.	Std. Pack	
	<ul style="list-style-type: none"> • Pluggable coupling relay • Overall width 15.8 mm • Screw terminals • 1 change-over contact 16A • 2 change-over contacts 8A 	flare MOVE		1 change-over contact		2 change-over contacts	
12V Relay module DC		80.010.4901.3	10	80.010.5101.2	10		
24V Relay module DC		80.010.4902.3	10	80.010.5102.2	10		
24V Relay module AC		80.010.4912.3	10				
115V Relay module AC		80.010.4915.3	10	80.010.5315.2	10		
230V Relay module AC		80.010.4916.3	10	80.010.5316.2	10		
Comb-shaped jumper 8pol. for A1, A2 max 10A		80.063.5029.2	10				
Marking tag BZ SF-48		80.063.5029.3	10				
Replacement relay		Information on request					
Technical data							
Maximum switching voltage		400 V AC		250 V AC			
Maximum switching current		16 A / (10 A up to 12 V)		8 A			
Maximum starting current		30 A / (20 A up to 12 V)		15 A			
Mechanical life DC / AC		2 x 10 ⁷ / 1 x 10 ⁷		2 x 10 ⁷			
Electrical life AC 1		2 x 10 ⁵ / 1 x 10 ⁵		1 x 10 ⁵			
Isolation voltage of input / output		4 kV					
Connectable via pluggable jumper		8 modules					
Wire range fine-stranded/solid		0.25 - 4 mm ² (AWG 24–12) / 0.25 - 6 mm ² (AWG 24–10)					
Degree of protection / Mounting rail		IP 20 / TS35					
Dimensions (mm) W x H x D		15.8 x 78.6 x 76					
Ambient temperature		-40 ... +70 °C					
Approvals		CE  					



Coupling relays

flare MOVE MR

- Pluggable coupling relay
- Robust pins
- Switching position is indicated mechanically
- Lockable test button
- For railway application accord. to EN 50 155
- Overall width 15.8 mm
- Screw terminals
- 1 change-over contact 16A
- 2 change-over contacts 8A



Description	Part No.	Std. Pack	Part No.	Std. Pack
flare MOVE MR	1 change-over contact		2 change-over contacts	
24V Relay module DC	80.010.6002.2	10	80.010.6032.2	10
24V Relay module DC with gold (5µm)	80.010.6002.3	10	80.010.6032.3	
Replacement relay	Information on request			
Comb-shaped jumper 8 pole for A1, A2 max 10A	80.063.5029.2	10		
Marking plate BM MR-4C	80.063.6029.3	10		
Technical data				
Maximum switching voltage	440 V AC		440 V AC	
Maximum switching current	16 A		8 A	
Maximum starting current	25 A		15 A	
Mechanical life	1 x 10 ⁷		1 x 10 ⁷	
Electrical life AC 1	1 x 10 ⁵		1 x 10 ⁵	
Isolation voltage of input / output	6 kV			
Wire range fine-stranded/solid	0.25 - 4 mm ² (AWG 24-12) / 0.25 - 6 mm ² (AWG 24-10)			
Degree of protection / Mounting rail	IP 20 / TS35			
Dimensions (mm) W x H x D	15.8 x 82.9 x 68.1			
Ambient temperature	-40...+70 °C (>12A max 50 °C) -40...+70 °C			
Approvals	CE TÜV			

flare MOVE MR

- Pluggable coupling relay
- Robust pins
- Switching position is indicated mechanically
- Lockable test button
- For railway application accord. to EN 50 155
- Overall width 15.8 mm
- Cage clamp
- 1 change-over contact 16A
- 2 change-over contacts 8A



Description	Part No.	Std. Pack	Part No.	Std. Pack
flare MOVE MR	1 change-over contact		2 change-over contacts	
24V Relay module DC	80.010.6102.2	10	80.010.6132.2	10
24V Relay module DC with gold (5µm)	80.010.6102.3	10	80.010.6132.3	10
Replacement relay	Information on request			
Marking plate BM MR-4C	80.063.6029.3	10		
Technical data				
Maximum switching voltage	400 V AC		400 V AC	
Maximum switching current	16 A		8 A	
Maximum starting current	25 A		15 A	
Mechanical life	1 x 10 ⁷		1 x 10 ⁷	
Electrical life AC 1	1 x 10 ⁵		1 x 10 ⁵	
Isolation voltage of input / output	6 kV			
Wire range fine-stranded/solid	0.2 - 1.5 mm ² (AWG 24-16)			
Degree of protection / Mounting rail	IP 20 / TS35			
Dimensions (mm) W x H x D	15.8 x 82.9 x 68.1			
Ambient temperature	-25...+70 °C (>12A max 50 °C) -25...+70 °C			
Approvals	CE TÜV			

flare MOVE MR

- Pluggable coupling relay
- Robust pins
- Switching position is indicated mechanically
- Lockable test button
- For railway application accord. to EN 50 155
- Overall width 27 mm
- Screw terminals
- 4 change-over contacts 7A



Description	Part No.	Std. Pack
flare MOVE MR	4 change-over contact	
24V Relay module DC	80.010.5702.2	10
Replacement relay	Information on request	
Technical data		
Maximum switching voltage	250 V AC	
Maximum switching current	7 A	
Maximum starting current	15 A	
Mechanical life	2 x 10 ⁷	
Electrical life AC 1	1.5 x 10 ⁵	
Isolation voltage of input / output	3.6 kV	
Wire range fine-stranded/solid	0.25 - 4 mm ² (AWG 24-12) / 0.25 - 6 mm ² (AWG 24-10)	
Degree of protection / Mounting rail	IP 20 / TS35	
Dimensions (mm) W x H x D	27 x 76 x 86.9	
Ambient temperature	-40...+70 °C	
Approvals	CE TÜV	

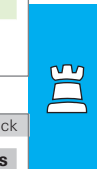

Coupling relays

<p>flare</p> <ul style="list-style-type: none"> • Compact coupling relay • Overall width 6.2 mm • Screw terminals/ Cage clamp • 1 change-over contact 6 A 	Description		Part No.	Std. Pack	Part No.	Std. Pack
	flare		Screw terminal		Cage clamp	
	12V Relay module DC				80.010.4106.0	10
	24V Relay module DC		80.010.4000.0	10	80.010.4100.0	10
	115V Relay module AC				80.010.4131.0	10
	230V Relay module AC				80.010.4141.0	10
	Pluggable jumper max 2A		Z8.000.0200.8	10		
	Jumper for potential distribution red		Z8.000.0202.3	5		
	Jumper for potential distribution blue		Z8.000.0202.4	5		
	Endcaps for jumper, red		Z8.000.0202.1	20		
	Endcaps for jumper, blue		Z8.000.0202.2	20		
	8 digit marking tag, unmarked, 60 pcs.		Z4.242.5153.0	10		
Technical data						
Maximum switching voltage		250 V AC / 300 V DC				
Maximum switching current		6 A AC / 2 A DC				
Maximum starting current		10 A				
Mechanical life		1 x 10 ⁷				
Electrical life up to 230V AC / 6A		8 x 10 ⁴				
Isolation voltage of input / output		4 kV _{eff}				
Connectable via pluggable jumper		50 modules				
Wire range fine-stranded/solid		0.5 - 2.5 mm ² (AWG 22–14) /		0.25 - 1.5 mm ² (AWG 24–16) /		
		0.25 - 4 mm ² (AWG 24–12)		0.25 - 2.5 mm ² (AWG 24–14)		
Degree of protection / Mounting rail		IP 20 / TS35				
Dimensions (mm) W x H x D		6.2 x 89 x 70				
Ambient temperature		0 ... +60 °C				
Approvals		CE TÜV GS Ex				

<p>flare</p> <ul style="list-style-type: none"> • Compact coupling relay • Overall width 6.2 mm / 12.4 (2 change-over contacts) • Screw terminals/ Cage clamp • Special Type 	Description		Part No.	Std. Pack	Part No.	Std. Pack	
	flare		Screw terminal		Cage clamp		
	24V Relay module AC/DC		80.010.4005.0	10	80.010.4105.0	10	
	1 change-over contact DC 48V 20mA with gold (3µm)						
	24V Relay module DC				80.010.4103.0	5	
	2 change-over contact AC 250V 6A AC/DC 300 V 2A DC						
	24V Knife edge disconnect relay AC/DC				80.010.4120.0	10	
	1 change-over contact AC 250V 6A / DC 300 V 2 A						
	24V HAND-0-AUTO-Relay				80.010.4101.0	10	
	1 normally open contact AC 250V 6A / DC 300V 2A						
	Technical data						
	Mechanical life		2 x 10 ⁷				
Electrical life up to 230V AC / 6A		6 x 10 ⁴					
Isolation voltage of input / output		4 kV _{eff}					
Connectable via pluggable jumper		50 modules					
Wire range fine-stranded/solid		0.5 - 2.5 mm ² (AWG 22–14) /		0.25 - 1.5 mm ² (AWG 24–16) /			
		0.25 - 4 mm ² (AWG 24–12)		0.25 - 2.5 mm ² (AWG 24–14)			
Degree of protection / Mounting rail		IP 20 / TS35					
Dimensions (mm) W x H x D		6.2 x 89 x 70 / 12.4 x 89 x 70 (2 change-over contacts)					
Ambient temperature		0 ... +60 °C 6 mm ²					
Approvals		CE TÜV GS Ex					



Coupling relays

Relay output modules

- Pluggable coupling relay
- Screw terminals
- 1 change-over contact / 2 change-over contacts
- 1 relay up to 16 relays
- 5 A switching capacity per output
- 12 V and 24 V

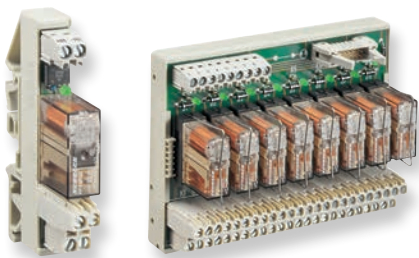

Description	Part No.	Std. Pack	Part No.	Std. Pack
Relay output modules	1 change-over contact		2 change-over contacts	
12V Module AC/DC 1 relay	87.220.7553.0	10		
24V Module DC 4 relay positive switching	87.220.1853.0	1	87.220.4753.3	1
24V Module DC 4 relay negative switching	87.221.5553.0	1		
24V Module DC 8 relay positive switching	87.220.1953.3	1	87.220.4853.3	1
24V Module DC 16 relay positive switching	87.220.2253.3	1		
Replacement relay	Z8.000.0056.9	10	Z8.000.0035.5	10

Technical data	
Maximum switching voltage	250 V AC/DC
Maximum switching current	5 A AC/DC
Maximum starting current	8 A AC/DC
Mechanical life	3 x 10 ⁷
Electrical life 230V AC / 5A	6 x 10 ⁵
Isolation voltage of input / output	4 kV
Wire range fine-stranded/solid	0.25 - 2.5 mm ² (AWG 24-14) / 0.5 - 4 mm ² (AWG 22-12)
Mounting rail	TS 35 / TS 32
Dimensions (mm) W x H x D	1 relay: 12.5x80x58.3 4/8/16 relay: 70/128/280x80x71
Ambient temperature	-25 ... +50 °C (Derating)
Approvals	CE

Relay output modules

- Pluggable coupling relay
- Screw terminals
- 1 change-over contact 4 A / 2 change-over contacts 5 A
- 1 relay up to 8 relays
- 115 V and 230 V AC/DC

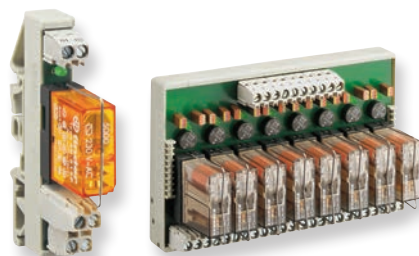

Description	Part No.	Std. Pack	Part No.	Std. Pack
Relay output modules	1 change-over contact		2 change-over contacts	
230 V Module AC/DC 1 relay	80.010.0011.0	10	80.010.1100.0	5
115 V Module AC/DC 4 relay	80.010.1102.0	1	80.010.1104.0	1
115 V Module AC/DC 8 relay	80.010.1110.0	1	80.010.1112.0	1
230 V Module AC/DC 4 relay	80.010.1106.0	1	80.010.1108.0	1
230 V Module AC/DC 8 relay	80.010.1114.0	1	80.010.1116.0	1
Replacement relay	Z8.000.0181.0	10	Z8.000.0176.2	10



Technical data	
Maximum switching voltage	250 V AC/DC
Maximum switching current	4 A AC/DC
Maximum starting current	6 A AC/DC
Mechanical life	3 x 10 ⁷
Electrical life 230V AC/nominal current	1.5 x 10 ⁵
Isolation voltage of input / output	4 kV
Wire range fine-stranded/solid	0.25 - 2.5 mm ² (AWG 24-14) / 0.5 - 4 mm ² (AWG 22-12)
Mounting rail	TS 35 / TS 32
Dimensions (mm) W x H x D	1 relay: 12.5 x 80 x 70 4/8 relay: 70/128 x 80 x 71
Ambient temperature	-40 ... +50 °C (Derating)
Approvals	CE

Coupling relays

Relay system

- Bridgeable relay system
- Screw terminals
- 1 normally open contact/
1 change-over contact
- 24 V AC/DC





Description	Part No.	Std. Pack	Part No.	Std. Pack
Relay system		Output		Input
24V Module AC/DC 1 normally open contact	80.010.0005.0	10	80.010.0007.0	10
24V Module AC/DC 1 change-over contact	80.010.0008.0	10	80.010.0009.0	10
Pluggable jumper max. 0.5A	Z8.000.0103.4	10		
Technical data				
Maximum switching voltage	250 V AC/DC		48 V DC (10 µm gold)	
Maximum switching current	5 A AC/DC		20 mA	
Maximum starting current	8 A AC/DC			
Mechanical life	3 x 10 ⁷		3 x 10 ⁷	
Electrical life (up to nominal rating)	2.5 x 10 ⁵		3 x 10 ⁶	
Isolation voltage of input / output	4 kV			
Wire range fine-stranded/solid	0.5 - 2.5 mm ² (AWG 22 - 14) / 0.5 - 4 mm ² (AWG 22 - 12)			
Mounting rail	TS 35 / TS 32			
Dimensions (mm) W x H x D	12.5 x 80 x 60			
Ambient temperature	-25 ... +50 °C (Derating up to 65 °C)			
Approvals	CE   			

Relay system

- Bridgeable relay system
- Screw terminals
- 2 change-over contacts 5 A
- 24 V AC/DC





Description	Part No.	Std. Pack	Part No.	Std. Pack
Relay system		Output		Input
24V Module AC/DC 2 change-over contacts	80.010.1003.0	5	80.010.1002.0	5
Pluggable jumper max. 0.5 A	Z8.000.0103.4	10		
Technical data				
Maximum switching voltage	250 V AC/DC		48 V DC (10 µm gold)	
Maximum switching current	5 A AC/DC		20 mA	
Maximum starting current	6 A AC/DC			
Mechanical life	3 x 10 ⁷		3 x 10 ⁷	
Electrical life (up to nominal rating)	2.5 x 10 ⁵		3 x 10 ⁶	
Isolation voltage of input / output	4 kV			
Wire range fine-stranded/solid	0.5 - 2.5 mm ² (AWG 22 - 14) / 0.5 - 4 mm ² (AWG 22 - 12)			
Mounting rail	TS 35 / TS 32			
Dimensions (mm) W x H x D	22.5 x 80 x 60			
Ambient temperature	-25 ... +50 °C			
Approvals	CE   			

Relay system

- Bridgeable relay system
- Screw terminals
- 1 change-over contact 16 A
- 24 V AC/DC



Description	Part No.	Std. Pack
Relay system		Output
24 V Module AC/DC 1 change-over contact	80.010.0010.0	5
Pluggable jumper max. 0.5 A	Z8.000.0103.4	10
Technical data		
Maximum switching voltage	250 V AC/DC	
Maximum switching current	16 A AC/DC	
Maximum starting current	16 A AC/DC	
Mechanical life	3 x 10 ⁷	
Electrical life (up to nominal rating)	1.8 x 10 ⁵	
Isolation voltage of input / output	4 kV	
Wire range fine-stranded/solid	0.5 - 2.5 mm ² (AWG 22 - 14) / 0.5 - 4 mm ² (AWG 22 - 12)	
Mounting rail	TS 35 / TS 32	
Dimensions (mm) W x H x D	22.5 x 80 x 60	
Ambient temperature	-25 ... +50 °C (Derating up to 65 °C)	
Approvals	CE   	



Solid-State relays

flare

- Compact solid-state relay
- Overall width 6.2 mm
- Spring cage clamp
- Output 48 V DC



Description	Part No.	Std. Pack	Part No.	Std. Pack
flare	Output 0,5 A		Output 2 A	
24 V Module DC / Output 48 V	80.020.4100.0	10	80.020.4101.0	10
115 V Module AC/DC / Output 48 V	80.020.4102.0	10		
230 V Module AC/DC / Output 48 V	80.020.4103.0	10		
Pluggable jumper max 2 A	Z8.000.0200.8	10		
8 digit marking tag, unmarked, 60 pcs.	Z4.242.5153.0	10		
Technical data				
Maximum switching voltage	48 V DC (4,4...53 V DC)			
Maximum switching current	0,5 A		2 A	
Min. switching current	0,1 mA		1 mA	
Isolation voltage of input / output	3,75 kV			
Connectable via pluggable jumper	50 modules			
Wire range fine-stranded/solid	0,25 -1,5 (AWG 24-16) / 0,25 - 2,5 mm ² (AWG 24-14)			
Degree of protection / Mounting rail	IP 20 / TS35			
Dimensions (mm) W x H x D	6,2 x 89 x 70			
Ambient temperature	0 ... +50 °C (Derating)			
Approvals	CE UL TS Ex			

flare

- Compact solid-state relay
- Overall width 6.2 mm
- Spring cage clamp
- Output 230 V AC



Description	Part No.	Std. Pack
flare	Output 0,5 A	
24V Module DC / Output 230 V AC	80.020.4150.0	10
Pluggable jumper max 2 A	Z8.000.0200.8	10
8 digit marking tag, unmarked, 60 pcs.	Z4.242.5153.0	10
Technical data		
Maximum switching voltage	250 V AC	
Maximum switching current	0,5 A	
Min. switching current	0,1 mA	
Isolation voltage of input / output	2,5 kV	
Connectable via pluggable jumper	50 modules	
Wire range fine-stranded/solid	0,25 -1,5 mm ² (AWG 24-16) / 0,25 - 2,5 mm ² (AWG 24-14)	
Degree of protection / Mounting rail	IP 20 / TS35	
Dimensions (mm) W x H x D	6,2 x 89 x 70	
Ambient temperature	0 ... +50 °C (Derating)	
Approvals	CE UL TS Ex	

Solid-state relay

- Bridgeable
- Screw terminals
- Output 60 V DC



Description	Part No.	Std. Pack
Solid-State-Relay	Output 5 A	
24 V Module DC / Output 48 V	80.020.2004.0	10
Pluggable jumper	Z8.000.0103.4	10
Technical data		
Maximum switching voltage	60 V DC (3...60 V)	
Maximum switching current	5 A DC (Derating)	
Min. switching current	20 mA	
Isolation voltage of input / output	4 kV	
Connectable via pluggable jumper	20 modules	
Wire range fine-stranded/solid	0,5 -2,5 mm ² (AWG 22-14) / 0,5 - 4 mm ² (AWG 22-12)	
Mounting rail	TS 35 / TS 32	
Dimensions (mm) W x H x D	12,5 x 80 x 59	
Ambient temperature	-20 ... +50 °C (Derating)	
Approvals	CE UL TS	

Solid-state relay

- Bridgeable
- Screw terminals
- Output 250 V AC



Description	Part No.	Std. Pack	Part No.	Std. Pack
Solid-State-Relay	Output 4 A		Output 6 A	
24 V Module DC / Output 250 V AC	80.020.2001.0	10	80.020.0004.0	10
Pluggable jumper	Z8.000.0103.4	10		
Technical data				
Maximum switching voltage	280 V AC (48...280 V)			
Maximum switching current	4 A		6 A	
Min. switching current	60 mA			
Isolation voltage of input / output	4 kV			
Connectable via pluggable jumper	20 modules			
Wire range fine-stranded/solid	0,5 -2,5 mm ² (AWG 22-14) / 0,5 - 4 mm ² (AWG 22-12)			
Mounting rail	TS 35 / TS 32			
Dimensions (mm) W x H x D	12,5 x 80 x 56		25,6 x 80 x 70	
Ambient temperature	-25 ... +50 °C (Derating)			
Approvals	CE UL TS			

Passive interface

Always the right connection

Control signals are carried from prefabricated cable harnesses to terminal connections.

Interface modules make the connection between electronic and electrical components within the control panel.

The use of Wieland interface modules provides the following benefits for system wiring:

Advantages:

- Simple process which saves time during design and calculation
- Rapid wiring, commissioning and trouble shooting due to clear cabling and pole designations
- Reduction of wiring errors
- Space savings due to high density terminations
- The interface modules are standardly fitted with a mounting foot for DIN / EN mounting rails TS 35 or TS 32.

D-SUB connector to screw terminal

- Height: 80 mm









Type	No. of poles	With (mm)	Part No.	Std. Pack
D-Sub female connector				
Buchse D-Sub9	9	38,7	87.200.2200.3	1
Buchse D-Sub15	15	48,2	87.200.2201.3	1
Buchse D-Sub25	25	74,0	87.200.2202.3	1
Buchse D-Sub37	37	106,0	87.200.2203.3	1
D-Sub male connector				
Stecker D-Sub9	9	38,7	87.200.2205.3	1
Stecker D-Sub15	15	48,2	87.200.2206.3	1
Stecker D-Sub25	25	74,0	87.200.2207.3	1
Stecker D-Sub37	37	106,0	87.200.2208.3	1
Technical Data				
Maximum nominal voltage	60 V AC / 75 V DC			
Maximum nominal current	1,5 A			
Wire range	15 A			
fine stranded	0,5 – 2,5 mm ²			
solid	0,5 – 4 mm ²			
Ambient temperature	0 ... +50 °C			
Installation of mounting rail	TS 35 or TS 32			
Standard/specifications	VDE 0110b Gr.2			
Terminal strip X2	Type 8191E (x poles)			

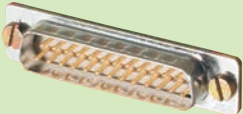

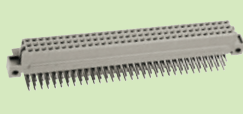
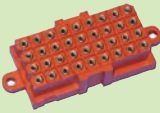

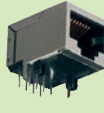

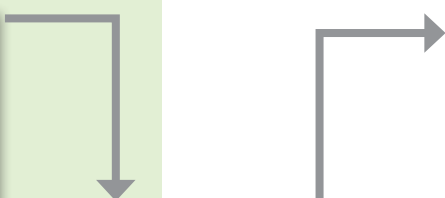

Customized Solutions

INPUT









Flat ribbon cable	
D-sub	
Screw terminal	
Spring terminal	
VG strips	
AMP-Metrimate	
Flat-pin connector	
Pluggable terminal	
RJ45	
GST 18	
High-current terminal	

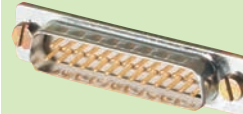

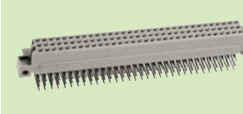
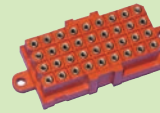
IMPLEMENTATION

LED	
Relay	
Optocoupler	
1 to 1	
Semiconductor-relay	
Function	
Fuses	

OUTPUT

Flat ribbon cable	
D-sub	
Screw terminal	
Spring terminal	
VG strips	
AMP-Metrimate	
Flat-pin connector	
Pluggable terminal	
RJ45	
GST 18	
High-current terminal	



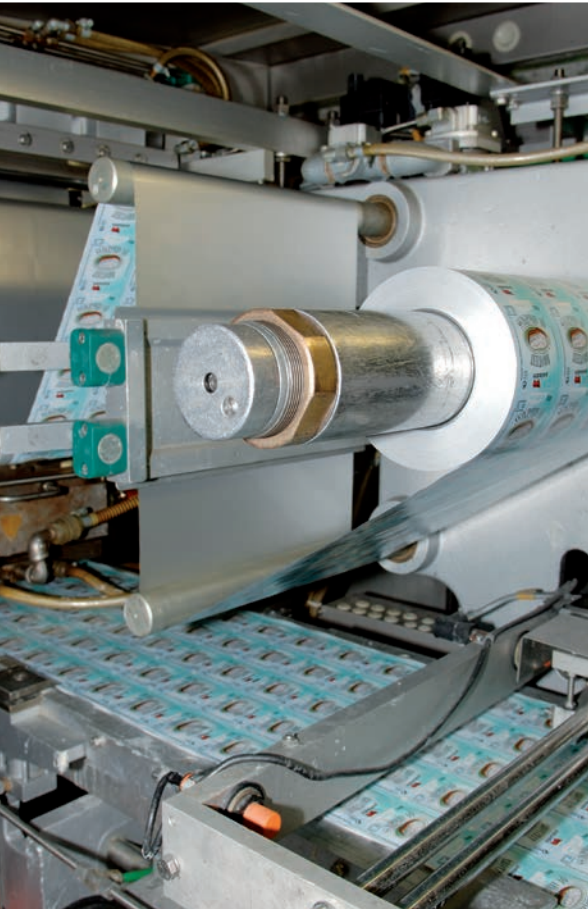

Analog Isolation Amplifier and flexible precise

Analog isolation amplifier of the **cores** series

The **cores** series convinces with flexible use in process and industrial automation.

They ensure a defined separation of measurement and process signals from the control system. And it protects against voltage drops.

Analogue isolation amplifiers also convert signals into standardized signal levels.

cores combines a highly precise signal conversion with a very small housing and fulfils actual demands for such products.

The Advantages:

- Digital conversion (up to 16 Bit)
- Highest accuracy (0.1 %) and linearity
- Fastest reaction time (from 11 ms)
- 3 or 4 way galvanic isolation
- High isolation voltage
- Compact housing (also as thin as 6.2 mm)
- Universal functions settable
- Wide temperature range



Analog Isolation Amplifier

cores C1 UI-B

- Analog Isolation Amplifier
- 3 way isolation
- Input: voltage / current, output: voltage / current
- High accuracy by digital conversion
- Width 6.2 mm
- Spring clamp connection
- Wide temperature range



Type	Part No.
cores C1 UI-B	82.003.0110.0
Technical data	
Input range (adjustable)	0/1 ... 5 V DC or 0/2 ... 10 V DC 0/4 ... 20 mA DC
Output range (adjustable)	0/1 ... 5 V DC or 0/2 ... 10 V DC 0/4 ... 20 mA DC or 20 ... 4/0 mA DC active or passive
Galvanic isolation	yes, 3 way isolation
Isolation voltage	1500 V AC
Accuracy	<0.1%, 14 Bit resolution
Supply voltage range	19.2 ... 30 V DC
Power consumption	max. 500 mW
Connection type	Spring clamp
Wire range solid/fine-stranded	0.2 - 2.5 mm ² (AWG 24-14)
Degree of protection / Mounting rail	IP 20 / TS 35 (EN60715)
Dimensions (mm) W x H x D	6.2 x 93.1 x 102.5
Temperature range	-20 ... +65 °C
Approvals (pending)	CE

cores C1 PT-B

- Analog Isolation Amplifier
- 3 way isolation
- Input: PT 100, output: voltage / current
- High accuracy by digital conversion
- Width 6.2 mm
- Spring clamp connection
- Wide temperature range



Type	Part No.
cores C1 PT-B	82.003.0120.0
Technical data	
Input range (adjustable)	PT100 with 2-, 3- or 4 wire connection -150 ... +650 °C
Output range (adjustable)	0/1 ... 5 V DC or 0 ... 10 V; 10 ... 0 V DC 0/4 ... 20 mA DC or 20 ... 4/0 mA DC
Galvanic isolation	yes, 3 way isolation
Isolation voltage	1500 V AC
Accuracy	<0.1%, 14 Bit resolution
Supply voltage range	19.2 ... 30 V DC
Power consumption	max. 500 mW
Connection type	Spring clamp
Wire range solid/fine-stranded	0.2 - 2.5 mm ² (AWG 24-14)
Degree of protection / Mounting rail	IP 20 / TS 35 (EN60715)
Dimensions (mm) W x H x D	6.2 x 93.1 x 102.5
Temperature range	-20 ... +65 °C
Approvals (pending)	CE

cores C1 TC-B

- Analog Isolation Amplifier
- 3 way isolation
- Input: thermo coupler, output: voltage / current
- High accuracy by digital conversion
- Width 6.2 mm
- Spring clamp connection
- Wide temperature range



Type	Part No.
cores C1 TC-B	82.003.0130.0
Technical data	
Input range (adjustable)	Types of thermo coupler: J, K, E, N, S, R, B, T
Output range (adjustable)	0/1 ... 5 V DC oder 0 ... 10 V DC 0/4 ... 20 mA DC oder 20 ... 4/0 mA DC
Galvanic isolation	yes, 3 way isolation
Isolation voltage	1500 V AC
Accuracy	<0.1%, 14 Bit resolution
Supply voltage range	19.2 ... 30 V DC
Power consumption	max. 500 mW
Connection type	Spring clamp
Wire range solid/fine-stranded	0.2 - 2.5 mm ² (AWG 24-14)
Degree of protection / Mounting rail	IP 20 / TS 35 (EN60715)
Dimensions (mm) W x H x D	6.2 x 93.1 x 102.5
Temperature range	-20 ... +65 °C
Approvals (pending)	CE

Analog Isolation Amplifier

cores C2 UI-A

- Analog Isolation Amplifier
- 3 way isolation
- Input: current, output: current
- High accuracy by digital conversion
- Width 17.5 mm
- Screw clamp pluggable
- Wide temperature range



Type	Part No.
cores C2 UI-A	82.003.0210.0
Technical data	
Input range (adjustable)	0 ... 20 mA DC active or passive
Output range (adjustable)	0 ... 20 mA DC active or passive
Galvanic isolation	yes, 3 way isolation
Isolation voltage	1500 V AC
Accuracy	<0.1%
Reaction time	<40 ms
Supply voltage range	9 ... 40 V DC, 19 ... 28 V AC
Power consumption	max. 2.5 W
Connection type	Screw clamp pluggable
Wire range solid/fine-stranded	0.14 - 2.5 mm ² (AWG 26-14)
Degree of protection / Mounting rail	IP 20 / TS 35 (EN60715)
Dimensions (mm) W x H x D	17.5 x 100 x 112
Temperature range	-20 ... +60 °C
Approvals (pending)	CE

cores C2 M-A / cores C2 MB-A

- Analog Isolation Amplifier
- 3 way isolation
- Input: voltage, current, thermo coupler, potentiometer, output: voltage, current
- High accuracy by digital conversion
- Width 17.5 mm
- Screw clamp pluggable
- Wide temperature range



Type	Part No.	Part No.
cores C2 M-A	82.003.0200.0	
cores C2 MB-A		82.003.0201.0
Technical data		
Input range (adjustable)	75 mV ... 20 V in 9 ranges (bipolar); 0 ... 20 mA (bipolar) J,K,R,S,T,B,E,N Thermo coupler; Pt100, Pt500, Pt1000, Ni100. 3 or 4 wire; 500 Ohm ... 10 kOhm Potentiometer; 500 Ohm ... 25 kOhm Rheostat	
Output range (adjustable)	0 (4) ... 20 mA, 0 ... 5 V, -20 ... +20 mA 0 ... 10 V, 1 ... 5 V, 2 ... 10 V -10 ... +10 V	
Galvanic isolation	yes, 3 way isolation	
Isolation voltage	1500 V AC	
Accuracy	<0.1%, 12 or 16 Bit resolution	
Reaction time	<35 ms (12 Bit), <140 ms (16 Bit) < 40 ms	
Supply voltage range	10...40 V DC, 19...28 V AC	9...40 V DC, 19...28 V AC
Power consumption	max. 2.5 W	max. 2 W
Connection type	Screw clamp pluggable	
Wire range solid/fine-stranded	0.14 - 2.5 mm ² (AWG 26-14)	
Degree of protection / Mounting rail	IP 20 / TS 35 (EN60715)	
Dimensions (mm) W x H x D	17.5 x 100 x 112	
Temperature range	-10 ... +60 °C	
Approvals (pending)	CE	CE

Configuration software can be downloaded from our homepage under service / software.

cores C2 M2-A

- Analog Isolation Amplifier
- 4 way isolation
- 2 analogue outputs
- Input: voltage, current, thermo coupler, potentiometer, output: voltage, current
- High accuracy by digital conversion
- Width 17.5 mm
- Screw clamp pluggable
- Wide temperature range



Type	Part No.
cores C2 M2-A	82.003.0250.0
Technical data	
Input range (adjustable)	0 ... +10V; 0 ... 20mA active or passive; J, K, R, S, T, B, E, N Thermo coupler; Pt100, Pt500, Pt1000, Ni100. 2, 3, 4 wire; 1 ... 100 kOhm Potentiometer; 500 Ohm ... 25 kOhm Rheostat
Output range (adjustable)	0 ... 20 mA or 4 ... 20 mA active or passive 0 ... +10 V
Galvanic isolation	yes, 4 way isolation
Isolation voltage	1500 V AC
Accuracy	<0.1%, 14 Bit resolution
Reaction time	<11 ms
Supply voltage range	10 ... 40 V DC, 19 ... 28 V AC
Power consumption	max. 2 W
Connection type	Screw clamp pluggable
Wire range solid/fine-stranded	0.14 - 2.5 mm ² (AWG 26-14)
Degree of protection / Mounting rail	IP 20 / TS 35 (EN60715)
Dimensions (mm) W x H x D	17.5 x 100 x 112
Temperature range	-10 ... +65 °C
Approvals (pending)	CE

Configuration software can be downloaded from our homepage under service / software.



I/O fieldbus system

Economical, compact and modular

In **ricos** FLEX, Wieland Electric is offering a continuous fieldbus concept for the interchange of data between controller and field periphery. The modular I/O nodes are installed decentrally, close to the machine, and networked via the fieldbus. A broad range of I/O modules process the various actuator/sensor signals. Diverse diagnostic functions permit a significant reduction in machine standstill times.



Advantages:

- Cost-efficiency through a highly modular design
- 2 to 8-channel modules
- Narrow module width of 12.9 mm
- Up to 64 modules can be connected to each bus coupler
- Spring tension connection terminals
- Very fast reaction time
- Individual channel inscription



High-performance rear wall bus

- 48 Mbit/s transmission speed
- Very fast reaction time of up to 20 μ s
- One connection module for all application modules

Easy to assemble/service

- Simplest assembly thanks to secure sliding mechanism
- Module protection through coding
- Service-friendly combination of connection module and application module
- Recommendation: top hat rail mounting (TS 35 x 15)

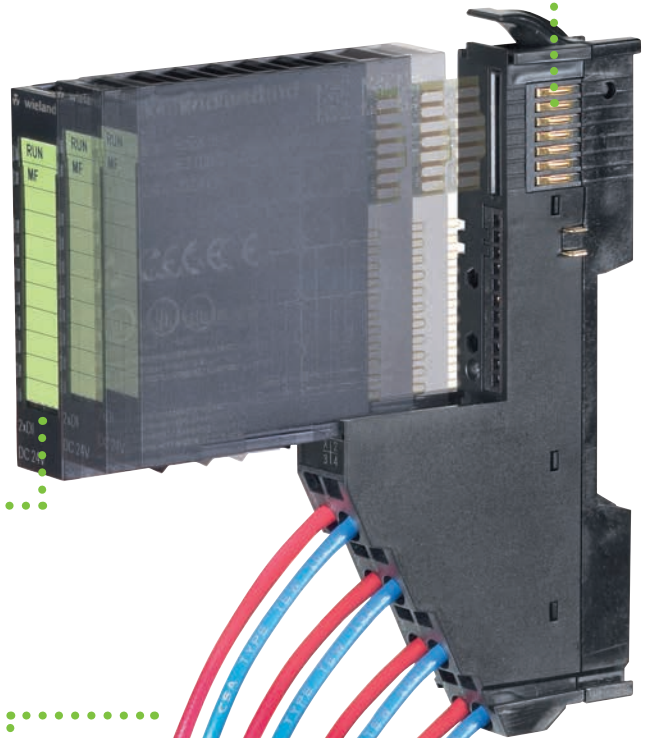

Space-saving connection technology

- Stepped wiring level with spring force terminal technology
- Simple module replacement with permanent wiring
- High modularity with 2, 4 and 8-channel modules



Clearly arranged status and diagnostic displays with direct channel assignment for fast troubleshooting.

Inscription strips for individual marking of each channel.



ricos FLEX

Can be combined and used for any application.

ricos FLEX is a module and extremely compact I/O system. It can be combined and used with any PLC and any IPC.

ricos FLEX combines high functionality with an intelligent housing concept in an extremely compact design.

ricos FLEX is highly compact and precisely, matched, bit by bit, to the requirements of the application concerned.

All bus couplers support up to 64 user modules. One module unit comprises a connection module and an electronic module, which are connected by means of a slide and click mechanism.

The connection module combines terminals, mounting for the electronic module and the **ricos** FLEX rear wall bus connector.

So for servicing, only the electronic module is replaced by simply pulling out the connection module – the wiring and mounting on the 25 mm DIN profile rail remain intact.

The spring force terminals arranged step-wise on the connection module permit fast, clearly arranged and safe wiring.

The integrated status LEDs and the inscription strips on the front of the electronic modules guarantee channel-specific, clear assignment and readability of the channel statuses.

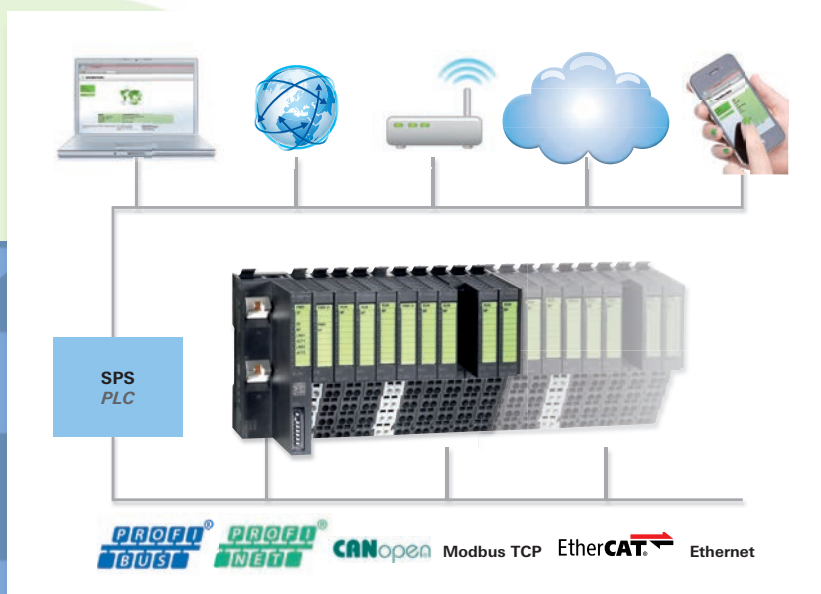

Bus coupler

ricos FLEX BC DP

- Bus coupler Profibus DP-V1 Slave
- 244 byte input and 244 byte output data
- 64 assemblies per assembly carrier



Type	Part No.
ricos FLEX BC DP	83.036.1000.0
Technical data	
Input voltage	20.4...28.8 V DC
Input current	0.95 A
Number of subscribers	125
Subscriber address	1 – 125
Baud rate	9.6 kbit/s - 12 Mbit/s
Address range for inputs	max. 244 bytes
Address range for outputs	max. 244 bytes
Fieldbus connection	9-pole sub-D socket
Fieldbus	Profibus DP to EN50170
Temperature range	0 ... +60 °C
Dimensions WxHxD (mm)	48.5 x 109 x 76.5
Mounting method	Top hat rail mounting
Weight	155 g
Terminal type	Spring force terminal
Terminal cross-section	0.08 – 1.5 mm ²
Approvals	CE

ricos FLEX BC CANopen

- Bus coupler CANopen Slave
- 16 RX and 16 TX PDOs
- 2 SDOs
- PDO linking
- PDO Mapping: fixed
- 64 assemblies per assembly carrier



Type	Part No.
ricos FLEX BC CANopen	83.036.1020.0
Technical data	
Input voltage	20.4...28.8 V DC
Input current	0.95 A
Number of subscribers	127
Subscriber address	1 – 127
Baud rate	10 kBaud - 1 MBaud
Address range for inputs	max. 128 bytes
Address range for outputs	max. 128 bytes
Fieldbus connection	9-pole sub-D plug
Fieldbus	CANopen
Temperature range	0 ... +60 °C
Dimensions WxHxD (mm)	48.5 x 109 x 76.5
Mounting method	Top hat rail mounting
Weight	155 g
Terminal type	Spring force terminal
Terminal cross-section	0.08 – 1.5 mm ²
Approvals	CE

ricos FLEX BC MODBUS

- Bus coupler MODBUS TCP Slave
- I/O configuration via the fieldbus
- 64 assemblies per assembly carrier



Type	Part No.
ricos FLEX BC MODBUS	83.036.1040.0
Technical data	
Input voltage	20.4...28.8 V DC
Input current	0.95 A
Fieldbus connection	RJ45 / Ethernet 10/100 MBit
Fieldbus	MODBUS-TCP
Temperature range	0 ... +60 °C
Dimensions WxHxD (mm)	48.5 x 109 x 76.5
Mounting method	Top hat rail mounting
Weight	155 g
Terminal type	Spring force terminal
Terminal cross-section	0.08 – 1.5 mm ²
Approvals	CE

Bus coupler

ricos FLEX BC PROFINET

- Bus coupler PROFINET I/O Slave
- Transmission rate 100 MBit/s
- 64 assemblies per assembly carrier



Type	Part No.
ricos FLEX BC PROFINET	83.036.1010.0
Technical data	
Input voltage	20.4...28.8 V DC
Input current	0.95 A
Baud rate	100 Mbit/s
Address range for inputs	512 bytes
Address range for outputs	512 bytes
Fieldbus connection	2 x RJ45 / Ethernet 100 MBit
Fieldbus	PROFINET-IO
Temperature range	0 ... +60 °C
Dimensions WxHxD (mm)	48.5 x 109 x 76.5
Mounting method	Top hat rail mounting
Weight	155 g
Terminal type	Spring force terminal
Terminal cross-section	0.08 – 1.5 mm ²
Approvals	• CE

ricos FLEX BC EtherNet/IP

- Bus coupler EtherNet/IP
- 1 KB input and 1 KB output data
- 64 assemblies per assembly carrier



Type	Part No.
ricos FLEX BC EtherNet/IP	83.036.1050.0
Technical data	
Input voltage	20.4...28.8 V DC
Input current	0.95 A
Baud rate	10/100 Mbit
Address range for inputs	max. 1KB
Address range for outputs	max. 1KB
Fieldbus connection	RJ45
Fieldbus	EtherNet/IP
Temperature range	0 ... +60 °C
Dimensions WxHxD (mm)	48.5 x 109 x 76.5
Mounting method	Top hat rail mounting
Weight	155 g
Terminal type	Spring force terminal
Terminal cross-section	0.08 – 1.5 mm ²
Approvals	• CE

ricos FLEX BC EtherCAT

- Bus coupler EtherCAT
- 512 Byte input and 512 Byte output data
- 64 assemblies per assembly carrier



Type	Part No.
ricos FLEX BC EtherCAT	83.036.1060.0
Technical data	
Input voltage	20.4...28.8 V DC
Input current	0.95 A
Number of participants	max. 65535
Baud rate	100 Mbit/s
Address range for inputs	max. 512 Byte
Address range for outputs	max. 512 Byte
Fieldbus connection	2 x RJ45
Fieldbus	EtherCAT
Temperature range	0 ... +60 °C
Dimensions WxHxD (mm)	48.5 x 109 x 76.5
Mounting method	Top hat rail mounting
Weight	155 g
Terminal type	Spring force terminal
Terminal cross-section	0.08 – 1.5 mm ²
Approvals	• CE



Expansion modules

ricos FLEX potential distributor

- Potential distributor
- For distributing 24 V DC and 0 V potentials



Type	Part No.
ricos FLEX PV 8xDC24V	83.036.0000.0
ricos FLEX PV 8xDC0V	83.036.0010.0
ricos FLEX PV 4xDC24V 4xDC0V	83.036.0020.0
Technical data	
Number of terminals	8 x 24 V DC 8 x 0 V DC 4 x 24 VDC; 4 x 0 V DC
Max. terminal voltage	30 V DC 0 V DC 30 V DC
Max. terminal current	10 A
Max. total current per module	10 A
Temperature range	0 ... +60 °C
Dimensions WxHxD (mm)	12.9 x 109 x 52.5
Mounting method	Top hat rail mounting
Weight	50 g
Terminal type	Spring force terminal
Terminal cross-section	0.08 – 1.5 mm ²
Approvals	

ricos FLEX power module

- Potential distributor
- Supply voltage 24 V DC, 10 A
- Reverse polarity protection
- Overvoltage protection



Type	Part No.
ricos FLEX PW DC 24V	83.036.0030.0
ricos FLEX PW 24V/5V	83.036.0040.0
Technical data	
Input voltage	20.4...28.8 V DC
Output voltage	24 V
Output current	10 A 4 A
Reverse polarity protection	yes
Overvoltage protection	36 V
Temperature range	0 ... +60 °C
Dimensions WxHxD (mm)	12.9 x 109 x 76.5
Mounting method	Top hat rail mounting
Weight	60 g
Terminal type	Spring force terminal
Terminal cross-section	0.08 – 1.5 mm ²
Approvals	

ricos FLEX digital input module

- Digital input module
- 2 / 4 / 8 inputs



Type	Part No.
ricos FLEX 2xDI DC24V	83.036.2100.0
ricos FLEX 4xDI DC24V	83.036.2200.0
ricos FLEX 8xDI DC24V	83.036.2300.0
Technical data	
Input voltage	20.4...28.8 V DC
Input current with signal 1	3 mA
Number of inputs	2 4 8
Switching level "0"	0...5 V DC
Switching level "1"	15...28,8 V DC
Channel status (high)	LED (green)
Temperature range	0 ... +60 °C
Dimensions WxHxD (mm)	12.9 x 109 x 76.5
Mounting method	Top hat rail mounting
Weight	60 g
Terminal type	Spring force terminal
Terminal cross-section	0.08 – 1.5 mm ²
Approvals	

Expansion modules

ricos FLEX digital output module

- Digital output module
- 2 / 4 / 8 outputs
- 2 relay outputs 30 V DC / 230 V AC; 3 A



Type	Part No.
ricos FLEX 2xDO DC24V 0,5A	83.036.3100.0
ricos FLEX 2xDO DC24V 2A	83.036.3110.0
ricos FLEX 2xDO DC30V 3A RELAY	83.036.3150.0
ricos FLEX 4xDO DC24V 0,5A	83.036.3200.0
ricos FLEX 4xDO DC24V 2A	83.036.3210.0
ricos FLEX 8xDO DC24V 0,5A	83.036.3300.0

Technical data	
Output voltage	20,4...28,8 V DC 30 V DC/ 230 V AC (Relay)
Output current with signal 1	0,5 A (2/4/8 DO), 2 A (2/4 DO), 3 A (Relay)
Number of outputs	2 2 2 x RELAY 4 4 8
Output protection	Short circuit and overload protection
Channel status (high)	LED (green)
Temperature range	0 ... +60 °C
Dimensions WxHxD (mm)	12.9 x 109 x 76.5
Mounting method	Top hat rail mounting
Weight	60 g
Terminal type	Spring force terminal
Terminal cross-section	0.08 – 1.5 mm ²
Approvals	CE

ricos FLEX analog input module

- Analog input module
- 4 inputs, 12 bit
- 4 wire, isolated



Type	Part No.
ricos FLEX 4xAI 12BIT 0...10V	83.036.4200.0
ricos FLEX 4xAI 12BIT 0(4)...20mA	83.036.4240.0
ricos FLEX 4xAI 12BIT -10V...+10V	83.036.4210.0
ricos FLEX 4xAI 16BIT R ,RTD	83.036.4261.0

Technical data	
Number of inputs	4 4 4 4
Measuring ranges	0...10 V 0(4)...20 mA -10 V...+10 V RTD,PT100
Auflösung in Bit	12 12 12 16
Conversion time	1.15 ms, all channels
Module status	LED (green)
Temperature range	0 ... +60 °C
Dimensions WxHxD (mm)	12.9 x 109 x 76.5
Mounting method	Top hat rail mounting
Weight	60 g
Terminal type	Spring force terminal
Terminal cross-section	0.08 – 1.5 mm ²
Approvals	CE

ricos FLEX analog output module

- Analog output module
- 4 outputs, 12 bit



Type	Part No.
ricos FLEX 4xAO 12BIT 0...10V	83.036.5200.0
ricos FLEX 4xAO 12BIT 0(4)...20mA	83.036.5220.0
ricos FLEX 4xAO 12BIT -10V...+10V	83.036.5210.0

Technical data	
Number of outputs	4 4 4
Measuring ranges	0...10 V 0(4)...20 mA -10 V...+10 V
Resolution in bits	12
Conversion time	2 ms, all channels
Module status	LED (green)
Temperature range	0 ... +60 °C
Dimensions WxHxD (mm)	12.9 x 109 x 76.5
Mounting method	Top hat rail mounting
Weight	60 g
Terminal type	Spring force terminal
Terminal cross-section	0.08 – 1.5 mm ²
Approvals	CE



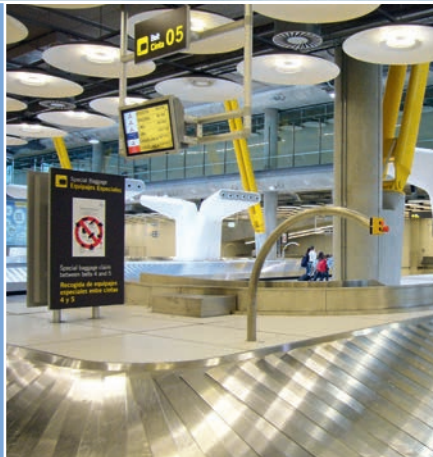
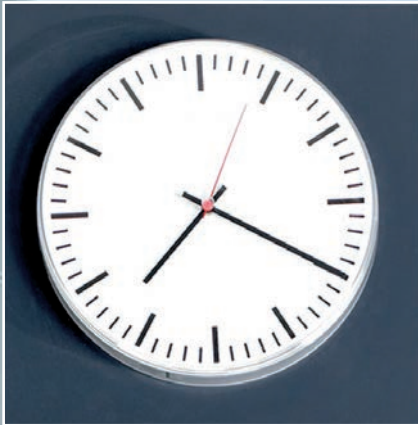

Timers

Always up to the minute

The electronic relays are ideally suited for standard, monitoring and control tasks in order to control function processes down to the second. Depending on the application, multiple-voltage and multi-functional relays are available.

Decades of timer know-how are packed into a completely new, highly miniaturized generation of timers just 22.5 mm wide. Although the end of the timer has been being predicted for years now, as the PLC has spread, high quality timers with well thought-out designs and universal application will continue to be needed in industrial automation.



Timers remain crucial – in less complex series machines, in later modifications, everywhere where other solutions would result in unnecessary engineering and hardware costs. For these applications Wieland offers a range of timers that provides everything you need. These devices unite diverse features with an efficiency that permits the fullest profitability – from procurement and warehousing through application and operation, and finally to disposal.



Multiple-voltage ergonomic and mobile

flare TIME series of timer relays

Our **flare** TIME family features universal application in the industrial automation sector. Up to 8 functions in just one relay cover all of your requirements and reduce inventory costs as well. Existing production processes can be easily expanded thanks to our **flare** TIME timer relay series, without incurring additional engineering and hardware costs. Our timer relays can be used in bakery machines, industrial washing machines, elevators and escalators, access controls and much more.

Features:

- Ambient temperatures from -25 °C to +60 °C
- Very high interference voltage resistance
- Output relays correspond to utilization category AC-15 and DC-13

The advantages:

- ① Power LED with progress display
- ② Function setting
- ③ Time range setting
- ④ Clear time setting
- ⑤ LED as status indicator of the change-over contact
- ⑥ Double connection points internally connected (HM series)

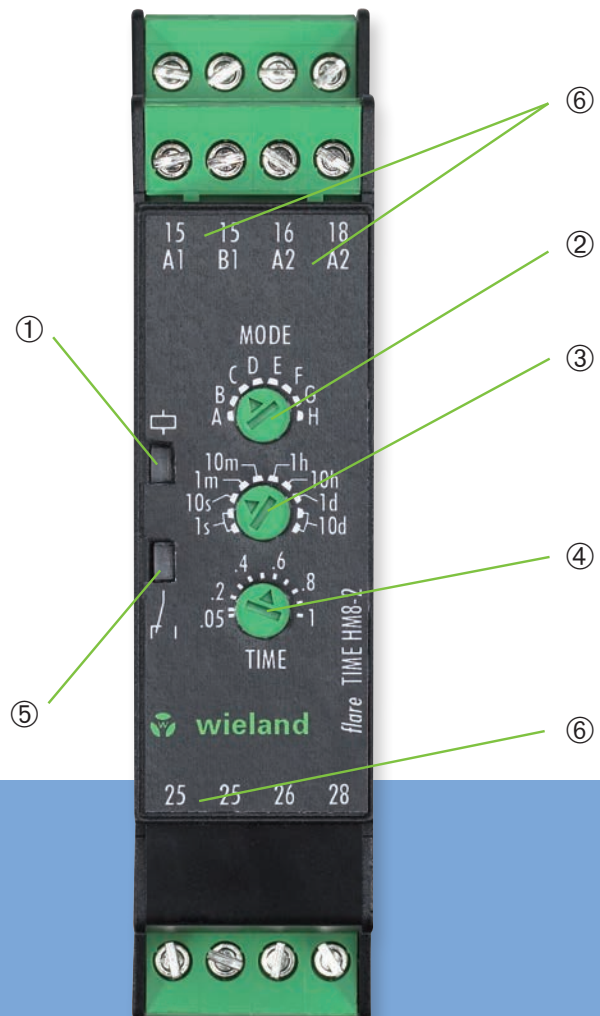



Electronic timer and switching relays for DIN rails



Electronic timer and switching relays for panel mounting



! Further products and technical details can be found at www.wieland-electric.com in our e-catalog.



Electronic timer and switching relays for DIN rails multifunction

Description		flare TIME HM8-2-A	flare TIME HM8-2U-A	flare TIME HM8-2P-A	flare TIME HM8-2PS-A	flare TIME HM5-1-A	flare TIME M8-2	flare TIME M8-1	flare TIME M4-2	flare TIME M4-1	flare TIME-S
Part no.		81.020.0104.0	81.020.0105.0	81.020.0134.0	81.020.0135.0	81.020.0100.0	81.020.0003.0	81.020.0002.0	81.020.0001.0	81.020.0000.0	81.020.4100.0
Model	Multi-function	•	•	•	•	•	•	•	•	•	•
	Multi-range	•	•	•	•	•	•	•	•	•	•
Function											
Timer relays	ON-delay	•	•	•	•	•	•	•	•	•	•
	OFF-delay	•	•	•	•	•	•	•	•	•	•
	ON-delay- and OFF-delay, symmetrical	•	•	•	•	•	•	•	•	•	•
Interval ON relay	Interval ON	•	•	•	•	•	•	•	•	•	•
	Single shot 0.5 sec (rising edge)	•	•	•	•	•	•	•	•	•	•
	Interval OFF	•	•	•	•	•	•	•	•	•	•
	Interval ON and Interval OFF	•	•	•	•	•	•	•	•	•	•
Repeat cycle timer	OFF start, symmetrical and selectable	•	•	•	•	•	•	•	•	•	•
	ON start, symmetrical and selectable	•	•	•	•	•	•	•	•	•	•
Watchdog	Cyclical signal monitoring	•	•	•	•	•	•	•	•	•	•
Pulse relay	Pulse relay, ON-delay, Pulse output	•	•	•	•	•	•	•	•	•	•
	Change relaystate (rising edge)	•	•	•	•	•	•	•	•	•	•
	Invert relay state (rising edge)	•	•	•	•	•	•	•	•	•	•
Contacts	Delayed changeover	2	1	2	1	1	2 ¹⁾	1	2 ¹⁾	1	1
	Immediate changeover	•	1	•	1	•	1 ¹⁾	•	1 ¹⁾	•	•
Rated Voltage	Multi-voltage AC/DC 24 to 230 (240) V	•	•	•	•	•	•	•	•	•	•
Special Features	Remote potentiometer connection	•	•	•	•	•	•	•	•	•	•
	Double connection points (internally connected) for trough cabling	•	•	•	•	•	•	•	•	•	•
	Digital (D) or analog (A) settings	A	A	A	A	A	A	A	A	A	A
Housing	Surface mounting 22.5 mm	•	•	•	•	•	•	•	•	•	•

1) = 1 delayed and 1 immediate changeover or 2 delayed changeovers, adjustable



Electronic timer and switching relays for DIN rails

flare TIME M

- Multi-function timer
- Multi-range time
- Wide input voltage range 20.4 ... 264 V AC/DC
- 4 or 8 selectable time functions
- 1 or 2 change-over contacts 5 A



Type	Part No.
flare TIME M4-1 (4 time functions / 1 contact)	81.020.0000.0
flare TIME M4-2 (4 time functions / 2 contacts)	81.020.0001.0
flare TIME M8-1 (8 time functions / 1 contact)	81.020.0002.0
flare TIME M8-2 (8 time functions / 2 contacts)	81.020.0003.0
Technical data	
Input voltage range	20,4 ... 264 V AC/DC
Time range	0.1 s ... 1200 h
Time functions	4 or 8
Number of change-over contacts	1 or 2
Maximum switching current	5 A
Mechanical life time	10 x 10 ⁶
Electrical life time AC1	0.1 x 10 ⁶
Isolation voltage of input/output	2 kV
Connection clamps	Screw clamp
Wire range fine-stranded/solid	0.14 - 2.5 mm ² (AWG 26 - 14)
Degree of protection / mounting rail	IP 20 / TS 35 (EN60715)
Dimensions (mm) W x H x D	22.5 x 89.4 x 100
Operation temperature range	-20 ... +55 °C
Approvals	CE

flare TIME HM

- Multi-function timer
- Multi-range time
- Wide input voltage range 20.4 ... 264 V AC/DC
- 5 or 8 selectable time functions
- Pluggable clamps
- Wide temperature range
- 1/2 change-over contacts 5 A; HM8-2PS-A 1 delayed, 1 immediate changeover



Type	Part No.
flare TIME HM5-1-A (5 time functions / 1 contact)	81.020.0100.0
flare TIME HM8-2-A (8 time functions / 2 contacts)	81.020.0104.0
flare TIME HM8-2U-A (4 time- / 4 special functions / 2 contacts)	81.020.0105.0
flare TIME HM8-2P-A (with remote control connection)	81.020.0134.0
flare TIME HM8-2PS-A (with remote control connection)	81.020.0135.0
Technical data	
Input voltage range	20,4 ... 264 V AC/DC
Time range	0.05 s ... 240 h
Time functions	5 or 8
Number of change-over contacts	1 or 2
Maximum switching current	5 A
Mechanical life time	20 x 10 ⁶
Electrical life time AC1	0.1 x 10 ⁶
Isolation voltage of input/output	2 kV
Connection clamps	Pluggable screw clamp
Wire range fine-stranded/solid	0.2 - 2.5 mm ² (AWG 24 - 14)
Degree of protection / mounting rail	IP 20 / TS 35 (EN60715)
Dimensions (mm) W x H x D	22.5 x 96.5 x 91.5
Operation temperature range	-40 ... +60 °C
Approvals	CE
Accessoires	
Remote control	F0.000.0031.9

flare TIME TWIN-1

- Multi-range repeat cycle timer
- Multi-range time
- ON- or OFF-start settable
- Time ON and OFF separate adjustable
- Wide input voltage range 20.4 ... 264 V AC/DC
- 1 change-over contacts 5 A



Type	Part No.
flare TIME TWIN-1	81.020.0011.0
Technical data	
Input voltage range	20,4 ... 264 V AC/DC
Time range	0.1 s ... 1200 h
Time functions	ON- or OFF-start
Number of change-over contacts	1
Maximum switching current	5 A
Mechanical life time	10 x 10 ⁶
Electrical life time AC1	0.1 x 10 ⁶
Isolation voltage of input/output	2 kV
Connection clamps	Screw clamp
Wire range fine-stranded/solid	0.14 - 2.5 mm ² (AWG 26 - 14)
Degree of protection / mounting rail	IP 20 / TS 35 (EN60715)
Dimensions (mm) W x H x D	22.5 x 89.4 x 100
Operation temperature range	-20 ... +55 °C
Approvals	CE



Electronic timer and switching relays for DIN rails

flare TIME OFF-1

- OFF delayed timer
- No auxiliary voltage necessary
- 2 time ranges setable
- 1 change-over contacts 5 A



Type	Part No.
flare TIME OFF-1	81.020.0010.0
Technical data	
Input voltage range	170 ... 264 V AC
Time range	1 ... 120 s
Time functions	OFF delay
Number of change-over contacts	1
Maximum switching current	5 A
Mechanical life time	10 x 10 ⁶
Electrical life time AC1	0.1 x 10 ⁶
Isolation voltage of input/output	2 kV
Connection clamps	Screw clamp
Wire range fine-stranded/solid	0.14 - 2.5 mm ² (AWG 26 - 14)
Degree of protection / Mounting rail	IP 20 / TS 35 (EN60715)
Dimensions (mm) W x H x D	22.5 x 89.4 x 100
Operation temperature range	-20 ... +55 °C
Approvals	CE, TÜV

flare TIMER-S

- Multi-function timer
- Spring clamp
- 1 change-over contact 6 A
- ON-delay and OFF-delay
- One shot and flashing



Type	Part No.
flare TIMER-S-250V6A	81.020.4100.0
Technical data	
Input voltage range	24 V DC +25%/-20%
Time range	0.1 ... 300 s
Number of change-over contacts	1
Maximum switching current	6 A
Mechanical life time	2 x 10 ⁷
Electrical life time at 24 V DC / 2 A	0.6 x 10 ⁶
Electrical life time at 230 V AC / 6 A	0.8 x 10 ⁵
Isolation voltage of input/output	4 kV
Connection clamps	Spring clamp
Wire range fine-stranded/solid	0.25 - 1.5 mm ² (AWG 24-16) / 0.25 - 2.5 mm ² (AWG 24-14)
Degree of protection / Mounting rail	IP 20 / TS 35 (EN60715)
Dimensions (mm) W x H x D	6.2 x 89 x 70mm
Operation temperature range	0 ... +50 °C
Approvals	UL, CE

Electronic time relay for front panel mounting

flare TIME FM15-1

- Multi-function timer
- High-contrast color display
- 15 time functions
- Front panel mounting 48 x 48 mm
- Wide temperature range
- 1 change-over contact 5 A



Type	Part No.	Part No.
flare TIME FM15-1 (24 V)	81.020.0020.0	
flare TIME FM15-1 (230 V)		81.020.0021.0
Technical data		
Input voltage range	4.5...30 V DC	85...264 V AC/DC
Time range	0.001 s ... 999 h	
Time functions	15	
Number of change-over contacts	1	
Maximum switching current	5A	
Mechanical life time	10 x 106	
Electrical life time AC1	0.1 x 106	
Isolation voltage of input/output	2 kV	
Connection clamps	Screw clamp	
Wire range fine-stranded/solid	0.14 - 2,5 mm ² (AWG 26-14)	
Degree of protection	IP20 / IP 66 (optional)	
Dimensions (mm) W x H x D	48 x 48 x 65	48 x 48 x 85,5
Operation temperature range	-10 ... +55 °C	
Approvals	CE 	

flare TIME FM6-2

- Multi-function timer
- 7-segment display, red
- 6 selectable functions
- Front panel mounting 72 x 72 mm
- Simple operation with the push/rotary button
- 2 change-over contacts, potential-free



Type	Part No.
flare TIME FM6-2	81.020.0025.0
Technical data	
Supply voltage	90 to 265 V AC/DC
Configurable time ranges	hh:mm / mm : ss
Setting ranges	0:01 to 99:59 hours / 0:01 to 99:59 minutes
Time functions	ON delay, OFF delay, Interval ON, Interval OFF, impulse generator starting with break, impulse generator starting with impulse
Behavior in case of voltage failure	Time retentivity (settable)
Number of change-over contacts	2
Switching capacity	max. 250 V AC, 5 A
Service life	> 100,000 switching cycles
Insulation voltage	Input / output / supply: 2 kV
Electrical isolation	All inputs, outputs and supply voltage
IP rating front / rear	IP54 / IP20
Housing front/panel cutout dimensions	72 x 72 mm / 68 x 68 mm
Operating temperature range	-25 ... +60°C
Conformity	EN 61812-1:2012
Approvals	CE





Measuring & control

precise and safe

Always live

Electronic measuring and monitoring relays for measuring input values such as current, voltage, 3-phases, cos phi, temperature. They carry out both simple and complex monitoring in machines and systems.



Features:

- The optimum device for every monitoring task
- Voltage, current, phase sequence, phase error, temperature or cos phi
- Broad temperature range
- Gold-plated switching contacts for maximum operational reliability

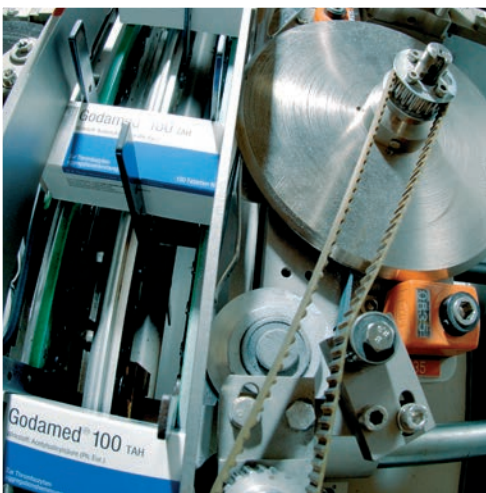

Benefits

- Upper and lower threshold separately adjustable
- 3 measuring ranges (single phase)
- Closed circuit or operating circuit principle
- Time delay 0 ... 10 s adjustable
- Wide input voltage range 20.4 ... 264 V AC/DC
- Width 22.5 mm
- Pluggable screw clamps
- Wide temperature range

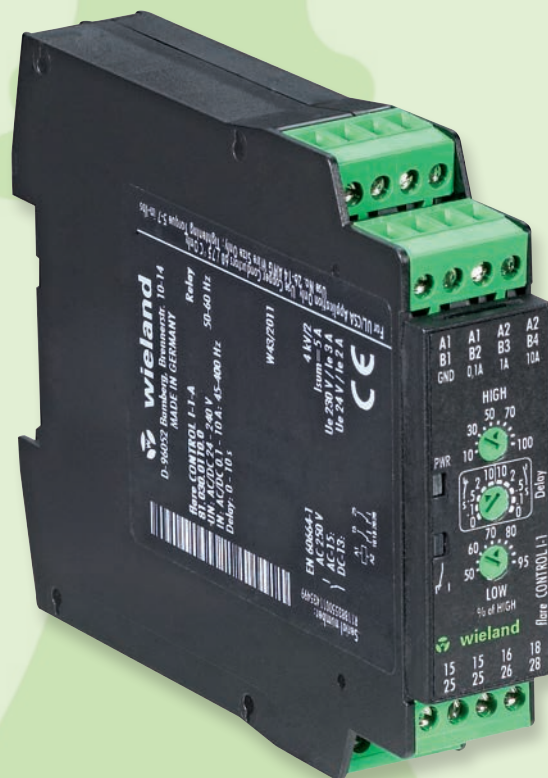

Multi-functional measuring relay

economical and flexible

Measuring relays **flare** CONTROL

The product family **flare** CONTROL convinces by the universal use in industrial automation.

All functions required for measuring relays are combined in one device. Only one type for current and voltage measurement is necessary.

This simplifies engineering and reduces stock.

Features:

- ① 3 measuring ranges in one device
- ② Power LED
- ③ Adjustable for closed circuit or operating circuit principle
In additional also time delay for exceeding the threshold
- ④ LED for exceedance of the threshold value
- ⑤ One terminal for supply voltage
- ⑥ Upper threshold in percent of measuring range
- ⑦ Lower threshold in percent of upper threshold
- ⑧ 2 changeover contacts simultaneously switching, one changeover contact output per terminal

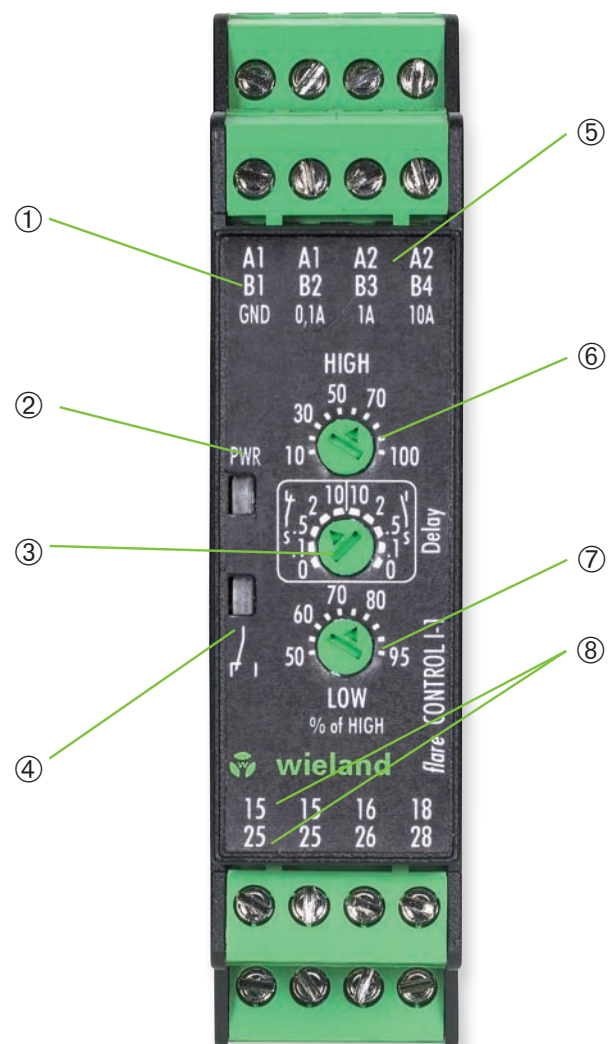

Measuring relay

flare CONTROL U-1-A | UL-1-A

- Multi-function measuring relay
- Upper and lower threshold separately adjustable
- 3 measurement ranges (single phase)
- Signal shape DC and sinus
- Closed circuit or operating circuit principle
- Response delay at threshold exceedance/ undercut adjustable
- Wide input voltage range 20.4 ... 264 V AC/DC
- Width 22.5 mm
- Pluggable screw clamps
- Wide temperature range
- 2 change-over contacts 5 A



Type	Part No.
Threshold exceedance	
flare CONTROL U-1-A	81.030.0100.0
Threshold undercut	
flare CONTROL UL-1-A	81.030.0101.0
Technical data	
Measuring ranges	5 / 50 / 300 V
Upper threshold U-1-A UL-1-A	10...100 % of measuring range
Lower threshold U-1-A	50 ... 95 % of upper threshold
Lower threshold UL-1-A	10...100 % of measuring range
Signal shape	DC and sinus
Nominal frequency of measured signal at AC	45 ... 400 Hz
Nominal power	app. 2 W / 4 VA
Supply voltage range	20.4 ... 264 V AC/DC
Galvanic isolation toward supply	Yes
Functions	Closed circuit or operating circuit principle
Time delay adjustable	0 / 0.1 / 0.5 / 2 / 10 s
Number of change-over contacts	2 (simultaneously switching)
Maximum switching current	5 A
Mechanical life time	20 x 10 ⁶
Electrical life time AC1	0.1 x 10 ⁶
Isolation voltage of input/output	2 kV
Connection clamps	Pluggable screw clamp
Wire range fine-stranded/solid	0.2 - 2.5 mm ² (AWG 24-14)
Degree of protection / mounting rail	IP 20 / TS 35 (EN60715)
Dimensions (mm) W x H x D	22.5 x 96.5 x 114
Operation temperature range	-25 ... +55 °C
Approvals U-1-A UL-1-A	CE

flare CONTROL I-1-A | IL-1-A

- Multi-function measuring relay
- Upper and lower threshold separately adjustable
- 3 measuring ranges (single phase)
- Signal shape DC and sinus
- Closed circuit or operating circuit principle
- Response delay at threshold exceedance/ undercut adjustable
- Wide input voltage range 20.4 ... 264 V AC/DC
- Width 22.5 mm
- Pluggable screw clamps
- Wide temperature range
- 2 change-over contacts 5 A



Type	Part No.
Threshold exceedance	
flare CONTROL I-1-A	81.030.0110.0
Threshold undercut	
flare CONTROL IL-1-A	81.030.0111.0
Technical data	
Measuring ranges	0,1 / 1 / 10 A
Upper threshold I-1-A IL-1-A	10...100 % of measuring range
Lower threshold I-1-A	50 ... 95 % of upper threshold
Lower threshold IL-1-A	10...100 % of measuring range
Signal shape	DC and sinus
Nominal frequency of measured signal at AC	45 ... 400 Hz
Nominal power	ca. 2 W / 4 VA
Supply voltage range	20.4 ... 264 V AC/DC
Galvanic isolation toward supply	Yes
Functions	Closed circuit or operating circuit principle
Time delay adjustable	0 / 0.1 / 0.5 / 2 / 10 s
Number of change-over contacts	2 (simultaneously switching)
Maximum switching current	5 A
Mechanical life time	20 x 10 ⁶
Electrical life time AC1	0.1 x 10 ⁶
Isolation voltage of input/output	2 kV
Connection clamps	Pluggable screw clamp
Wire range fine-stranded/solid	0.2 - 2.5 mm ² (AWG 24-14)
Degree of protection / mounting rail	IP 20 / TS 35 (EN60715)
Dimensions (mm) W x H x D	22.5 x 96.5 x 114
Operation temperature range	-25 ... +55 °C
Approvals I-1-A IL-1-A	CE



Monitoring relay

flare CONTROL P3-L

- 3 phase monitoring relay
- Detection for loss of one or more phases
- Detection of wrong phase sequence
- Closed circuit principle
- Width 22.5 mm
- 2 change-over contacts 5 A



Type	Part No.
flare CONTROL P3-L	81.030.0020.1
Technical data	
Supply voltage range	200 ... 480 V AC
Detection time	max. 0.1 s
Number of change-over contacts	2
Maximum switching current	5 A
Mechanical life time	10 x 10 ⁶
Electrical life time AC1	0.05 x 10 ⁶
Connection clamps	Screw clamp
Wire range fine-stranded/solid	0.14 - 4 mm ² (AWG 26 - 12)
Degree of protection / Mounting rail	IP 20 / TS 35 (EN60715)
Dimensions (mm) W x H x D	22.5 x 100 x 100
Operation temperature range	-20 ... +60°C
Approvals	CE 

flare CONTROL P3-LTN

- 3 phase monitoring relay
- 3 or 4 wire monitoring
- Detection for loss of one or more phases
- Detection of wrong phase sequence
- Adjustable asymmetry trigger 3 wire
- Closed circuit principle
- Supports worldwide mains systems (adjustable)
- Width 22,5 mm
- 1 change-over contacts 5 A



Type	Part No.
flare CONTROL P3-LTN	81.030.0021.1
Technical data	
Supply voltage 3 phase / 3 wire	380, 400, 415, 480 V AC
Supply voltage 3 phase / 4 wire	220, 230, 240, 277 V AC
Detection range for asymmetry	2 ... 22 %
Detection time at asymmetry	0.1 ... 30 s
Number of change-over contacts	1
Maximum switching current	5 A
Mechanical life time	10 x 10 ⁶
Electrical life time AC1	0.05 x 10 ⁶
Connection clamps	Screw clamp
Wire range fine-stranded/solid	0.14 - 4 mm ² (AWG 26 - 12)
Degree of protection / Mounting rail	IP 20 / TS 35 (EN60715)
Dimensions (mm) W x H x D	22.5 x 100 x 100
Operation temperature range	-20 ... +60 °C
Approvals	CE 





wietap Overvoltage protection

Important information on overvoltage

The necessity of overvoltage protection on machines and systems as well as for building technology is ever increasing. The potential danger of damage and even complete destruction posed to valuable electronic components or even complete production systems, computer systems or communication systems by sudden overvoltage from the grid, or direct lightning strikes has mobilized not just insurance companies. Well-advised users also know the importance of protecting their electrical devices, plants and systems both sufficiently and reliably against this danger, and the overall advantage of increasing their system availability.



Overvoltage protection modules

Overvoltage protection modules come in three type categories which designate their capacity to absorb overvoltage energy. Type 1 arresters can divert the largest amount of energy to ground (PE). The ideal installation location for these devices is at the building's main supply. In this configuration the impulse energy is considerably weakened, if it moves downstream into the installation. In sub-panels and control cabinets, this surplus energy is reduced further by type 2 and 3 arresters, thus maintaining the survival of the protected devices.



Table 1

LEMP protection for buildings with electrical and electronic systems according to IEC 62305-4 (DIN EN 62305-4, DIN 0185-305-4)

Lightning protection zones

- LPZ 0_A At risk from direct lightning strikes, impulse currents up to the full lightning current and through the full lightning field.
- LPZ 0_B Protected against direct lightning strike. At risk from impulse currents up to partial lightning currents and through the full lightning field.
- LPZ 1 Impulse currents further limited by current division and SPDs at the zone limits. In most cases, the lightning field is attenuated by shields.
- LPZ 2 Impulse currents further limited by current division and SPDs at the zone limits. In most cases, the lightning field is attenuated by local shields.



Playing it safe with **overvoltage protection**

Very short response time and high discharge capacity

With its considerably expanded **wietap** product range, Wieland Electric offers comprehensive solutions for overvoltage protection in control cabinets and sub panels of machines and buildings, as well as for photovoltaic systems. The components, which are modular and DIN rail mountable, range from the ready-to-connect 3-phase combi-arrester **wietap V M** for the main distribution, to the overvoltage protection module **wietap G M** for sub panels, up to the overvoltage module **wietap R M** intended for the control cabinet or constructed into the equipment.

All components are designed for application temperatures from -40 to 80 °C and have a high discharge capacity. Devices are also available with a remote signaling contact.

Properties of **wietap**:

- Electrically coordinated product family
- Highest discharge capacity up to 100 kA
- No tripping of fuses thanks to follow current limitation
- Latching pluggable protection modules
- Vibration and shock tested acc. to EN 60068-2
- Visual function & defect display for every path
- Modules replaceable without tools
- Can also be used in front of vertical power meter



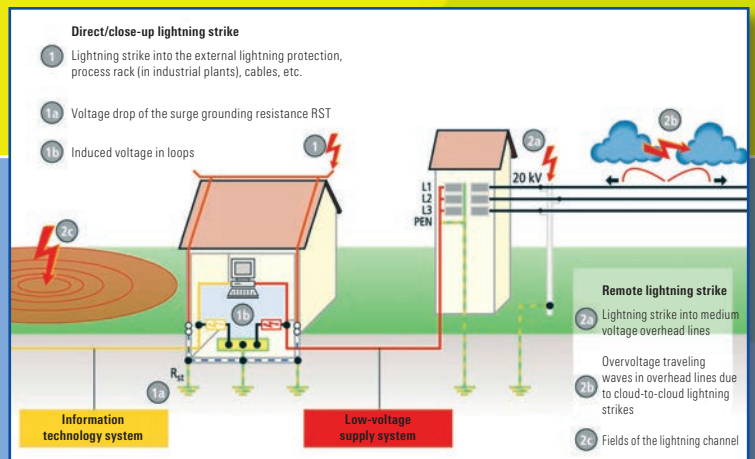
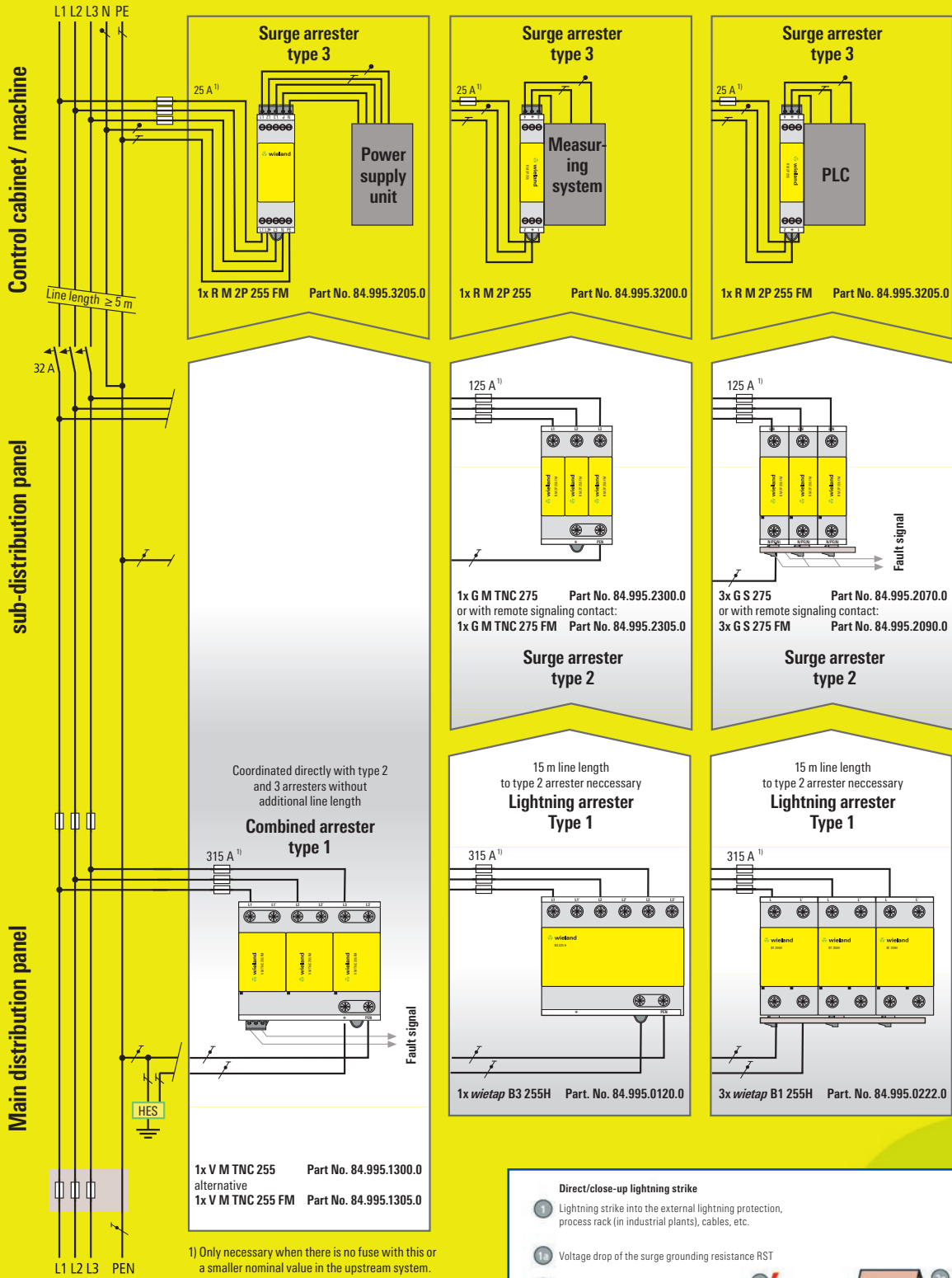

Figure 1

Overvoltage protection

The zone concept for lightning protection

The **zone concept for lightning protection** enables planners, builders and owners to plan, implement and monitor protective measures. All relevant devices, plants and systems can thus be protected reliably at economically justifiable costs.

Direct or close-up lightning strikes are lightning strikes into the lightning protection system of a building, in close proximity to it, or into the electrically conductive systems implemented in the building (e.g. low-voltage supply, telecommunications, control lines). (Fig. 1)

Remote lightning strikes are lightning strikes that occur far away from the object to be protected as well as lightning strikes into the medium voltage overhead system or in close proximity to it, or lightning discharge from cloud to cloud (Fig. 1: cases 2a, 2b and 2c).

In addition to a lightning protection system in the building, additional measures for an overvoltage protection of electrical and electronic systems are required in order to **safeguard the continuous availability** of complex power engineering and IT systems even in the case of a direct lightning strike. It is important to consider all the causes for over-voltages.

The zone concept for **lightning protection** as described in IEC 62305-4 (DIN EN 62305-4, DIN 0185-305-4) applies accordingly (Fig. 3). It divides a building into different risk zones. The relevant protective measures can then be derived for each zone, especially the devices and components for lightning and overvoltage protection.

The zones for lightning protection are defined as described in Table 1.

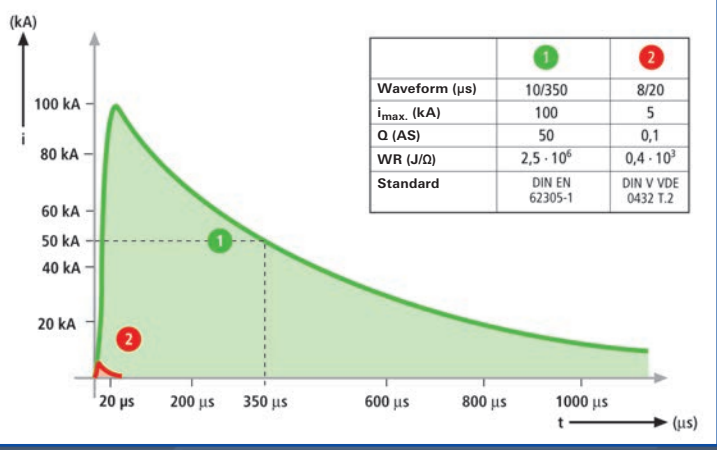

Figure 2: ① Peak current for testing of lightning arresters
 ② Peak current for testing of surge arresters

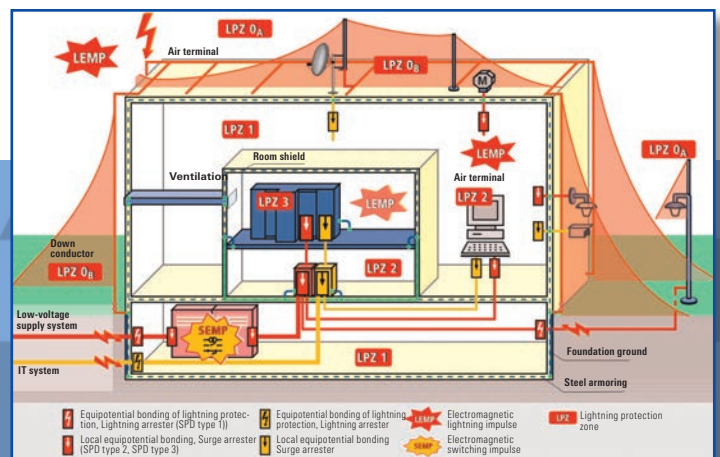

Figure 3: EMC-oriented zone concept for lightning protection



Three-phase combined arrester, type 1 (2, 3)

For protection of the building main supply

wietap V M TNC 255 (FM)

- Combined arrester, type 1
- For TN-C-systems
- With pluggable protection modules
- Max. system availability due to follow current limitation
- Switch-off selective for 20 A gL/gG fuses up to 50 kA_{eff} short-circuit current
- Discharge capacity up to 75 kA (10/350)
- Function/failure indication according to VDE 0100-534
- Optional with remote signaling contact (FM)
- Vibration and shock tested acc. to EN 60068-2

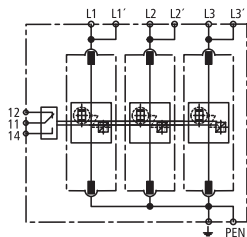

Type	Part No.
wietap V M TNC 255	84.995.1300.0
wietap V M TNC 255 FM	84.995.1305.0
Replacement module L1, L2, L3 against \neq	84.995.1001.0
Power network	TN-C
SPD accord. to EN 61643-11 / IEC 61643-11	Type 1 + Type 2 / Class I + Class II
Energy-coordinated protective function to the end device $\leq 5m$	Type 1 + Type 2 + Type 3
Nominal voltage AC [U _N]	230 / 400 V (50 / 60 Hz)
Maximum continuous voltage AC [U _c]	255 V (50 / 60 Hz)
Lightn. impulse current (10/350) [L1+L2+L3-PEN] [I _{total}]	75 kA
Lightn. impulse current (10/350) [L-PEN] [I _{imp}]	25 kA
Nominal discharge current (8/20) [I _n]	25 / 75 kA
Protection level [U _p]	≤ 1.5 kV
Follow current extinguishing capability AC [I _{fr}]	50 kA _{eff}
Limitation of follow current / selectivity	Non-tripping of a 20 A gL/gG fuse up to 50 kA _{eff} (prosp.)
Operating time [t _A]	≤ 100 ns
Max. pre-fusing (L) up to I _k = 50 kA _{eff}	315 A gG
Max. pre-fusing (L) up to I _k = 100 kA _{eff}	315 A gL/gG
Max. pre-fusing (L-L')	125 A gG
TOV-voltage [U _T] – characteristic	440 V / 120 min. – withstand
Temperature range (Parallel wiring) [T _{UP}]	-40 ... +80 °C
Temperature range (Through wiring) [T _{US}]	-40 ... +60 °C
Function/failure indication	green / red
Wire range (L1, L1', L2, L2', L3, L3', PEN, \neq) [min.]	10 mm ² (AWG 8) solid/fine-stranded
Wire range (L1, L2, L3, PEN) [max.]	50 mm ² (AWG 1) stranded/35 mm ² (AWG 2) fine-stranded
Wire range (L1', L2', L3', \neq) [max.]	35 mm ² (AWG 2) stranded/25 mm ² (AWG 4) fine-stranded
Mounted on DIN rail acc. to EN 60715	35 mm
Housing material	Thermoplast, UL 94 V-0
Degree of protection	IP 20
Dimensions	6 TE, DIN 43880 (108 mm)
Remote signaling contacts = Contact Type	Change-over contact
Switching capacity AC (FM)	250 V/0.5 A
Switching capacity DC (FM)	250 V/0.1 A; 125 V/0.2 A; 75 V/0.5 A
Wire range for remote signaling terminals	max. 1.5 mm ² (AWG 16) solid/fine-stranded
Approvals	CE

wietap V M TNS 255 (FM)

- Combined arrester Type 1
- For TN-S-systems
- With pluggable protection modules
- Max. system availability due to follow current limitation
- Switch-off selective for 20 A gL/gG fuses up to 50 kA_{eff} short-circuit current
- Discharge capacity up to 100 kA (10/350)
- Function/failure indication according to VDE 0100-534 (valid since March 2009)
- Optional with remote signaling contact (FM)
- Vibration and shock tested acc. to EN 60068-2

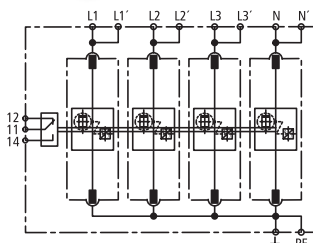

Type	Part No.
wietap V M TNS 255	84.995.1400.0
wietap V M TNS 255 FM	84.995.1405.0
Replacement module L1, L2, L3, N against \neq	84.995.1001.0
Power network	TN-S
SPD accord. to EN 61643-11 / IEC 61643-11	Type 1 + Type 2 / Class I + Class II
Energy-coordinated protective function to the end device $\leq 5m$	Type 1 + Type 2 + Type 3
Nominal voltage AC [U _N]	230 / 400 V (50 / 60 Hz)
Maximum continuous voltage AC [U _c]	264 V (50 / 60 Hz)
Lightn. impulse current (10/350) [L1+L2+L3-PEN] [I _{total}]	100 kA
Lightn. impulse current (10/350) [L, N-PE] [I _{imp}]	25 kA
Nominal discharge current (8/20) [I _n]	25 / 100 kA
Protection level [L, N-PE] [U _p]	≤ 1.5 kV
Follow current extinguishing capability AC [I _{fr}]	50 kA _{eff} / 50 kA _{eff}
Limitation of follow current / selectivity	Non-tripping of a 20 A gL/gG fuse up to 50 kA _{eff} (prosp.)
Operating time [t _A]	≤ 100 ns
Max. pre-fusing (L) up to I _k = 50 kA _{eff}	315 A gL/gG
Max. pre-fusing (L) up to I _k = 100 kA _{eff}	315 A gL/gG
Max. pre-fusing (L-L')	125 A gL/gG
TOV-voltage [L-N] [U _T] – characteristic	440 V / 120 min. – withstand
Temperature range (Parallel wiring) [T _{UP}]	-40 ... +80 °C
Temperature range (Through wiring) [T _{US}]	-40 ... +60 °C
Function/failure indication	green / red
Wire range (L1, L1', L2, L2', L3, L3', N, N', PE, \neq) [min.]	10 mm ² (AWG 8) solid/fine-stranded
Wire range (L1, L2, L3, PE, N) [max.]	50 mm ² (AWG 1) stranded/35 mm ² (AWG 2) fine-stranded
Wire range (L1', L2', L3', N', \neq) [max.]	35 mm ² (AWG 2) stranded/25 mm ² (AWG 4) fine-stranded
Mounted on DIN rail acc. to EN 60715	35 mm
Housing material	Thermoplast, UL 94 V-0
Degree of protection	IP 20
Dimensions	8 TE, DIN 43880 (144 mm)
Remote signaling contacts = Contact Type	Change-over contact
Switching capacity AC (FM)	250 V/0.5 A
Switching capacity DC (FM)	250 V/0.1 A; 125 V/0.2 A; 75 V/0.5 A
Wire range for remote signaling terminals	max. 1.5 mm ² (AWG 16) solid/fine-stranded
Approvals	CE

Three-phase combined arrester, type 1 (2, 3)

For protection of the building main supply

wietap V M TT 255 (FM)

- Combined arrester Type 1
- For TT- and TN-S-systems ("3+1" circuits)
- With pluggable protection modules
- Max. system availability due to follow current limitation
- Switch-off selective for 20 A gL/gG fuses up to 50 kA_{eff} short-circuit current
- Discharge capacity up to 100 kA (10/350)
- Function/failure indication according to VDE 0100-534
- Optional with remote signaling contact (FM)
- Vibration and shock tested acc. to EN 60068-2

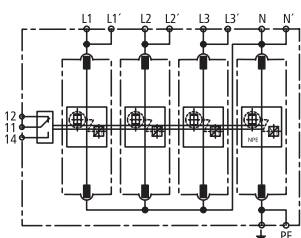

Type	Part No.
wietap V M TT 255	84.995.1310.0
wietap V M TT 255 FM	84.995.1315.0
Replacement module L1, L2, L3 against N	84.995.1001.0
Replacement module N against \varnothing	84.995.1100.0
Power network	TT and TN-S
SPD according to EN 61643-11 / IEC 61643-11	Type 1 + Type 2 / Class I + Class II
Energy-coordinated protective function to the end device ≤ 5 m	Type 1 + Type 2 + Type 3
Nominal voltage AC [U _N]	230 / 400 V (50 / 60 Hz)
Maximum continuous voltage AC [L-N] [U _c]	264 V (50 / 60 Hz)
Maximum continuous voltage AC [N-PE] [U _{c(N-PE)}]	255 V (50 / 60 Hz)
Lightn. impulse current (10/350) [L1+L2+L3 +N-PE] [I _{total}]	100 kA
Lightn. impulse current (10/350) [L-N] [I _{imp}]	25 kA
Lightn. impulse current (10/350) [N-PE] [I _{imp}]	100 kA
Nominal discharge current (8/20) [I _n]	25 / 100 kA
Protection level [L-N, N-PE] [U _p]	≤ 1.5 kV
Follow current extinguishing capability [L-N]/[N-PE] AC [I _n]	50 kA _{eff} / 100 A _{eff}
Limitation of follow current / selectivity	Non-tripping of a 20 A gL/gG fuse up to 50 kA _{eff} (prosp.)
Operating time [t _Δ]	≤ 100 ns
Max. pre-fusing (L) up to I _K = 50 kA _{eff}	315 A gG
Max. pre-fusing (L) up to I _K = 100 kA _{eff}	315 A gL/gG
Max. pre-fusing (L-L')	125 A gL/gG
TOV-voltage [L-N] [U _T] – characteristic	440 V / 120 min. – withstand
TOV-voltage [N-PE] [U _T] – characteristic	1200 V / 200 ms – withstand
Temperature range (Parallel wiring) [T _{UP}]	-40 ... +80 °C
Temperature range (Through wiring) [T _{US}]	-40 ... +60 °C
Function/failure indication	green / red
Wire range (L1, L1', L2, L2', L3, L3', N, N', PE, \varnothing) [min.]	10 mm ² (AWG 8) solid/fine-stranded
Wire range (L1, L2, L3, N, PE) [max.]	50 mm ² (AWG 1) stranded/35 mm ² (AWG 2) fine-stranded
Wire range (L1', L2', L3', N, \varnothing) [max.]	35 mm ² (AWG 2) stranded/25 mm ² (AWG 4) fine-stranded
Mounted on DIN rail acc. to EN 60715	35 mm
Housing material	Thermoplast, UL 94 V-0
Degree of protection	IP 20
Dimensions	8 TE, DIN 43880 (144 mm)
Remote signaling contacts = Contact Type	Change-over contact
Switching capacity AC (FM)	250 V/0.5 A
Switching capacity DC (FM)	250 V/0.1 A; 125 V/0.2 A; 75 V/0.5 A
Wire range for remote signaling terminals	max. 1.5 mm ² (AWG 16) solid/fine-stranded
Approvals	CE

Replacement module for wietap VM devices

wietap V MOD 255

Network spark gap protection module for all L – \varnothing ; L – N and for wietap V M TNS 255 (FM) N – \varnothing



wietap V MOD NPE 100

Network spark gap protection module for wietap V M TT 255 (FM) N – \varnothing



Type	Part No.
wietap V MOD 255	84.995.1001.0
wietap V MOD NPE 100	84.995.1100.0

3-phase lightning arrester, type 1

For protection of the building main supply

wietap B3 255H

- Lightning arrester, type 1
- For all systems (in connection with **wietap** GPM 255 if required)
- High limitation of follow current
- 50 kA discharge capacity per pole
- High insulation resistance; can therefore also be placed in front of the meter
- Double terminals for V connection

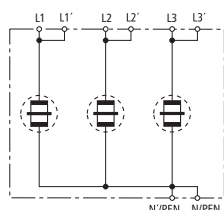

Type	Part No.
wietap B3 255H	84.995.0120.0
Technical Data	
SPD accord. to EN 61643-11 / IEC 61643-11	Type 1 / Class I
Nominal voltage AC [U _N]	230 / 400 V (50 / 60 Hz)
Maximum continuous voltage AC [U _c]	255 V (50 / 60 Hz)
Lightn. impulse current (10/350) [L-N/PEN] [I _{imp}]	50 kA
Lightn. impulse current (10/350) [L1+L2+L3-N/PEN] [I _{total}]	100 kA
Protection level [U _p]	≤ 4 kV
Follow current extinguishing capability AC [I _n]	50 kA _{eff}
Limitation of follow current / selectivity	Non-tripping of a 35 A gL/gG fuse up to 50 kA _{eff} (prosp.)
Operating time [t _a]	≤ 100 ns
Max. pre-fusing bis IK = 50 kA _{eff} (t _a ≤ 0,2 s)	500 A gG
Max. pre-fusing bis IK = 50 kA _{eff} (t _a ≤ 5 s)	315 A gG
Max. pre-fusing bei IK > 50 kA _{eff}	200 A gG
Max. pre-fusing (L-L')	125 A gG
TOV-voltage [U _T] – characteristic	440 V / 120 min. – withstand
Temperature range (Parallel wiring) [T _{UP}]	-40 ... +80 °C
Temperature range (Through wiring) [T _{US}]	-40 ... +60 °C
Wire range (L1, L1', L2, L2', L3, L3', N/PEN, N'/PEN)	10 mm ² (AWG 8) solid/fine-stranded
Wire range (L1, L2, L3, N/PEN)	50 mm ² (AWG 1) stranded / 35 mm ² (AWG 2) fine-stranded
Wire range (L1', L2', L3', N'/PEN)	35 mm ² (AWG 2) stranded / 25 mm ² (AWG 4) fine-stranded
Mounted on DIN rail acc. to EN 60715	35 mm
Housing material	Thermoplast, UL 94 V-0
Degree of protection	IP 20
Dimensions	6 TE, DIN 43880 (108 mm)
Approvals	CE

1-phase lightning arrester, type 1

For the protection of the building main supply

wietap B1 255H

- Lightning arrester, type 1
- For all systems (in connection with **wietap** GPM 255 if required)
- High limitation of follow current
- 50 kA discharge capacity per pole
- High insulation resistance; can therefore also be placed in front of the meter
- Double terminals for V connection

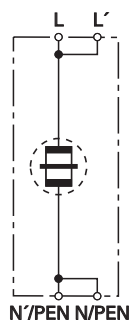

Type	Part No.
wietap B1 255H	84.995.0222.0
Technical Data	
SPD accord. to EN 61643-11 / IEC 61643-11	Type 1 / Class I
Nominal voltage ac [U _N]	230 V (50 / 60 Hz)
Maximum continuous voltage AC [U _c]	255 V (50 / 60 Hz)
Lightn. impulse current (10/350) [I _{imp}]	50 kA
Protection level [U _p]	≤ 4 kV
Follow current extinguishing capability AC [I _n]	50 kA _{eff}
Limitation of follow current / selectivity	Non-tripping of a 35 A gL/gG fuse up to 50 kA _{eff} (prosp.)
Operating time [t _a]	≤ 100 ns
Max. pre-fusing bis IK = 50 kA _{eff} (t _a ≤ 0,2 s)	500 A gG
Max. pre-fusing bis IK = 50 kA _{eff} (t _a ≤ 5 s)	315 A gG
Max. pre-fusing bei IK > 50 kA _{eff}	200 A gG
Max. pre-fusing (L-L')	125 A gG
TOV-voltage [U _T] – characteristic	440 V / 120 min. – withstand
Temperature range (Parallel wiring) [T _{UP}]	-40 ... +80 °C
Temperature range (Through wiring) [T _{US}]	-40 ... +60 °C
Wire range (L, L', N/PEN, N'/PEN) [min.]	10 mm ² (AWG 8) solid/fine-stranded
Wire range (L, N/PEN) [max.]	50 mm ² (AWG 1) stranded / 35 mm ² (AWG 2) fine-stranded
Wire range (L', N'/PEN) [max.]	35 mm ² (AWG 2) stranded / 25 mm ² (AWG 4) fine-stranded
Mounted on DIN rail acc. to EN 60715	35 mm
Housing material	Thermoplast, UL 94 V-0
Degree of protection	IP 20
Dimensions	2 TE, DIN 43880 (36 mm)
Approvals	CE

N-PE lightning arrester, type 1

For protection of the building main supply

wietap GPM 255

- N-PE lightning arrester, type 1
- In combination with **wietap** B1 255H or **wietap** B3 255H
- 100 kA discharge capacity

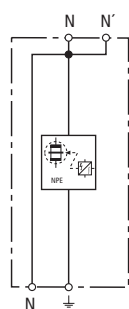

Type	Part No.
wietap GPM 255	84.995.0055.0
Technical Data	
SPD accord. to EN 61643-11 / IEC 61643-11	Type 1 / Class I
Maximum continuous voltage AC [U _c]	255 V
Lightn. impulse current (10/350) [I _{imp}]	100 kA
Protection level [U _p]	≤ 1.5 kV
Follow current extinguishing capability AC [I _{ni}]	100 Aeff
Operating time [t _a]	≤ 100 ns
TOV-voltage – characteristic	1200 V / 200 ms – withstand
Temperature range (Parallel wiring) [T _{up}]	-40 ... +80 °C
Temperature range (Through wiring) [T _{us}]	-40 ... +60 °C
Function/failure indication	green / red
Wire range (min.)	10 mm ² (AWG 8) solid/fine-stranded
Wire range (max.)	50 mm ² (AWG 1) stranded / 35 mm ² (AWG 2) fine-stranded
Mounted on DIN rail acc. to EN 60715	35 mm
Housing material	Thermoplast, UL 94 V-0
Degree of protection	IP 20
Dimensions	2 TE, DIN 43880 (36 mm)
Approvals	CE



Three-phase combined arrester, type 2

For protection of sub-distributions or the control cabinet main supply

wietap G M TNC 275 (FM)

- Surge arrester, type 2
- For TN-C-systems
- With pluggable protection modules
- Function/failure indication according to VDE 0100-534
- Optional with remote signaling contact (FM)
- Vibration and shock tested acc. to EN 60068-2

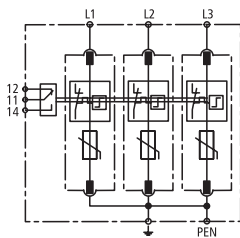

Type	Part No.
wietap G M TNC 275	84.995.2300.0
wietap G M TNC 275 FM	84.995.2305.0
Replacement module L1, L2, L3 against \pm	84.995.2010.0
Power network	TN-C
SPD accord. to EN 61643-11 / IEC 61643-11	Type 2 / Class II
Nominal voltage AC [U _N]	230 / 400 V (50 / 60 Hz)
Maximum continuous voltage AC [U _C]	275 V (50 / 60 Hz)
Nominal discharge current (8/20) [I _n]	20 kA
Max. discharge current (8/20) [I _{max}]	40 kA
Protection level [U _p]	≤ 1.5 kV
Protection level at 5 kA [U _p]	≤ 1 kV
Operating time [t _A]	≤ 25 ns
Maximum network overcurrent protection	125 A gG
Short-circuit proof with max. network overcurrent protection	50 kA _{eff}
TOV-voltage [U _T] – characteristic	335 V / 5 sec. – withstand
TOV-voltage [U _T] – characteristic	440 V / 120 min. – safe failure
Temperature range [T _U]	-40 ... +80 °C
Function/failure indication	green / red
Wire range (min.)	1.5 mm ² (AWG 14) solid/fine-stranded
Wire range (max.)	35 mm ² (AWG 2) stranded / 25 mm ² (AWG 4) fine-stranded
Mounted on DIN rail acc. to EN 60715	35 mm
Housing material	Thermoplast, UL 94 V-0
Degree of protection	IP 20
Dimensions	3 TE, DIN 43880 (54 mm)
Remote signaling contacts = Contact Type	Change-over contact
Switching capacity AC (FM)	250 V/0.5 A
Switching capacity DC (FM)	250 V/0.1 A; 125 V/0.2 A; 75 V/0.5 A
Wire range for remote signaling terminals	max. 1.5 mm ² (AWG 14) solid/fine-stranded
Approvals	CE

wietap G M TNS 275 (FM)

- Surge arrester, type 2
- For TN-S-systems
- With pluggable protection modules
- Function/failure indication according to VDE 0100-534
- Optional with remote signaling contact (FM)
- Vibration and shock tested acc. to EN 60068-2

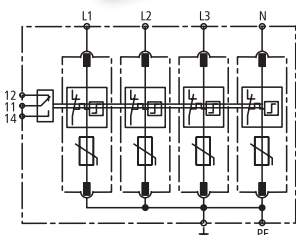

Type	Part No.
wietap G M TNS 275	84.995.2400.0
wietap G M TNS 275 FM	84.995.2405.0
Replacement module L1, L2, L3, N against \pm	84.995.2010.0
Power network	TN-S
SPD accord. to EN 61643-11 / IEC 61643-11	Type 2 / Class II
Nominal voltage AC [U _N]	230 / 400 V (50 / 60 Hz)
Maximum continuous voltage AC [U _C]	275 V (50 / 60 Hz)
Nominal discharge current (8/20) [I _n]	20 kA
Max. discharge current (8/20) [I _{max}]	40 kA
Protection level [U _p]	≤ 1.5 kV
Protection level at 5 kA [U _p]	≤ 1 kV
Operating time [t _A]	≤ 25 ns
Maximum network overcurrent protection	125 A gG
Short-circuit proof with max. network overcurrent protection	50 kA _{eff}
TOV-voltage [U _T] – characteristic	335 V / 5 sec. – withstand
TOV-voltage [U _T] – characteristic	440 V / 120 min. – safe failure
Temperature range [T _U]	-40 ... +80 °C
Function/failure indication	green / red
Wire range (min.)	1.5 mm ² (AWG 14) solid/fine-stranded
Wire range (max.)	35 mm ² (AWG 2) stranded / 25 mm ² (AWG 4) fine-stranded
Mounted on DIN rail acc. to EN 60715	35 mm
Housing material	Thermoplast, UL 94 V-0
Degree of protection	IP 20
Dimensions	4 TE, DIN 43880 (72 mm)
Remote signaling contacts = Contact Type	Change-over contact
Switching capacity AC (FM)	250 V/0.5 A
Switching capacity DC (FM)	250 V/0.1 A; 125 V/0.2 A; 75 V/0.5 A
Wire range for remote signaling terminals	max. 1.5 mm ² (AWG 14) solid/fine-stranded
Approvals	CE

Three-phase combined arrester, type 2

For protection of sub-distributions or the control cabinet main supply

wietap G M TT 275 (FM)

- Surge arrester, type 2
- For TT- and TN-S-systems ("3+1" circuits)
- With pluggable protection modules
- Function/failure indication according to VDE 0100-534
- Optional with remote signaling contact (FM)
- Vibration and shock tested acc. to EN 60068-2

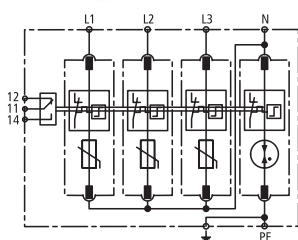

Type	Part No.
wietap G M TT 275	84.995.2310.0
wietap G M TT 275 FM	84.995.2315.0
Replacement module L1, L2, L3 against N	84.995.2010.0
Replacement module N against PE	84.995.2050.0
Power network	TT and TN-S (Variante „3+1“)
SPD accord. to EN 61643-11 / IEC 61643-11	Type 2 / Class II
Nominal voltage AC [U _N]	230 / 400 V (50 / 60 Hz)
Maximum continuous voltage AC [L-N] [U _C]	275 V (50 / 60 Hz)
Maximum continuous voltage AC [N-PE] [U _C]	255 V (50 / 60 Hz)
Nominal discharge current (8/20) [I _n]	20 kA
Max. discharge current (8/20) [I _{max}]	40 kA
Lightn. impulse current (10/350) [N-PE] [I _{imp}]	12 kA
Protection level [L-N] [U _P]	≤ 1.5 kV
Protection level [L-N] at 5 kA [U _P]	≤ 1 kV
Protection level [N-PE] [U _P]	≤ 1.5 kV
Follow current extinguishing capability [N-PE] [I _{ri}]	100 A _{eff}
Operating time [L-N] [t _Δ]	≤ 25 ns
Operating time [N-PE] [t _Δ]	≤ 100 ns
Maximum network overcurrent protection	125 A gG
Short-circuit proof with network overcurrent protection with 25 A gL/gG	50 kA _{eff}
TOV-voltage [L-N] [U _T] – characteristic	335 V / 5 sec. – withstand
TOV-voltage [L-N] [U _T] – characteristic	440 V / 120 min. – safe failure
TOV-voltage [N-PE] [U _T] – characteristic	1200 V / 200 ms – withstand
Temperature range [T _U]	-40 ... +80 °C
Function/failure indication	green / red
Wire range (min.)	1.5 mm ² (AWG 14) solid/fine-stranded
Wire range (max.)	35 mm ² (AWG 2) stranded / 25 mm ² (AWG 4) fine-stranded
Mounted on DIN rail acc. to EN 60715	35 mm
Housing material	Thermoplast, UL 94 V-0
Degree of protection	IP 20
Dimensions	4 TE, DIN 43880 (72 mm)
Remote signaling contacts = Contact Type	Change-over contact
Switching capacity AC (FM)	250 V/0.5 A
Switching capacity DC (FM)	250 V/0.1 A; 125 V/0.2 A; 75 V/0.5 A
Wire range for remote signaling terminals	max. 1.5 mm ² (AWG 14) solid/fine-stranded
Approvals	CE

Replacement module for wietap G M devices

wietap G MOD 275

Varistor protection module for all L – PE ; L – N and for wietap G M TNS 275 (FM) N – PE



wietap G MOD NPE

Spark gap protection module for N – PE and for wietap G M TT 275 (FM) N – PE



Type	Part No.
wietap G MOD 275	84.995.2010.0
wietap G MOD NPE	84.995.2050.0

Single-phase surge arrester, type 2

For protection of sub-distributions or the control cabinet main supply

wietap G S 275 (FM)

- Surge arrester, type 2
- All-purpose surge arrester
- With pluggable protection modules
- High discharge capacity due to powerful zinc oxid varistor
- High reliability due to arrester monitoring
- Slim design (modular construction) acc. to DIN 43880
- Multi-function connection for conductors and comb rails
- Function/failure indication according to VDE 0100-534
- Optional with remote signaling contact (FM)
- Vibration and shock tested acc. to EN 60068-2

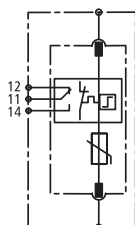

Type	Part No.
wietap G S 275	84.995.2070.0
wietap G S 275 FM	84.995.2090.0
Power network	universal
SPD accord. to EN 61643-11 / IEC 61643-11	Type 2 / Class II
Nominal voltage AC [U _N]	230 V (50 / 60 Hz)
Maximum continuous voltage AC [U _C]	275 V (50 / 60 Hz)
Maximum continuous voltage DC [U _C]	350 V
Nominal discharge current (8/20) [I _n]	20 kA
Max. discharge current (8/20) [I _{max}]	40 kA
Protection level [U _P]	≤ 1.5 kV
Protection level at 5 kA [U _P]	≤ 1 kV
Operating time [t _A]	≤ 25 ns
Maximum network overcurrent protection	125 A gG
Short-circuit proof with max. network overcurrent protection	50 kA _{eff}
TOV-voltage [U _T] – characteristic	335 V / 5 sec. – withstand
TOV-voltage [U _T] – characteristic	440 V / 120 min. – safe failure
Temperature range [T _U]	-40 ... +80 °C
Function/failure indication	green / red
Wire range (min.)	1.5 mm ² (AWG 14) solid/fine-stranded
Wire range (max.)	35 mm ² (AWG 2) stranded / 25 mm ² (AWG 4) fine-stranded
Mounted on DIN rail acc. to EN 60715	35 mm
Housing material	Thermoplast, UL 94 V-0
Degree of protection	IP 20
Dimensions	1 TE, DIN 43880 (18 mm)
Remote signaling contacts = Contact Type	Change-over contact
Switching capacity AC (FM)	250 V/0,5 A
Switching capacity DC (FM)	250 V/0.1 A; 125 V/0.2 A; 75 V/0.5 A
Wire range for remote signaling terminals	max. 1.5 mm ² (AWG 14) solid/fine-stranded
Approvals	CE

wietap G MOD 275

- Replacement module for wietap G S 275 (FM)



Type	Part No.
wietap G MOD 275	84.995.2010.0

Single-phase surge arrester, type 2

For protection of sub-distributions or the control cabinet main supply

wietap GP C S (FM)

- Surge arrester, type 2
- For use in TT systems in "3+1" and "1+1" circuits acc. to E DIN VDE 0100-534 between neutral conductor N and protective conductor PE
- High discharge capacity
- With pluggable protection modules
- Function/failure indication according to VDE 0100-534
- Optional with remote signaling contact (FM)
- Vibration and shock tested acc. to EN 60068-2

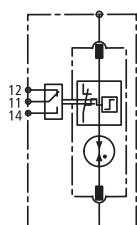

Type	Part No.
wietap GP C S	84.995.2030.0
wietap GP C S FM	84.995.2035.0
Power network	TT
SPD accord. to EN 61643-11 / IEC 61643-11	Type 2 / Class II
Maximum continuous voltage AC [U _c]	255 V (50 / 60 Hz)
Nominal discharge current (8/20) [I _n]	20 kA
Max. discharge current (8/20) [I _{max}]	40 kA
Follow current extinguishing capability [I _{ff}]	100 A _{eff}
Lightn. impulse current (10/350) [I _{imp}]	12 kA
Protection level [U _p]	≤ 1.5 kV
Operating time [t _a]	≤ 100 ns
TOV-voltage [U _T] – characteristic	1200 V / 200 ms – withstand
Temperature range [T _U]	-40 ... +80 °C
Function/failure indication	green / red
Wire range (min.)	1.5 mm ² (AWG 14) solid/fine-stranded
Wire range (max.)	35 mm ² (AWG 2) stranded / 25 mm ² (AWG 4) fine-stranded
Mounted on DIN rail acc. to EN 60715	35 mm
Housing material	Thermoplast, UL 94 V-0
Degree of protection	IP 20
Dimensions	1 TE, DIN 43880 (18 mm)
Remote signaling contacts = Contact Type	Change-over contact
Switching capacity AC(FM)	250 V/0.5 A
Switching capacity DC (FM)	250 V/0.1 A; 125 V/0.2 A; 75 V/0.5 A
Wire range for remote signaling terminals	max. 1.5 mm ² (AWG 14) solid/fine-stranded
Approvals	CE

wietap GP C MOD

- Replacement module for wietap G CS (FM)



Type	Part No.
wietap GP C MOD	84.995.2060.0



Surge arrester, type 3

For direct load protection in control cabinets or sub-distributions

wietap R M 2P 30 FM wietap R M 2P 255 (FM)

- Surge arrester, type 3
- Two-pole surge arrester
- High discharge capacity due to powerful zinc oxide varistor
- Slim design (modular construction) acc. to DIN 43880
- With pluggable protection modules
- Function/failure indication according to VDE 0100-534
- Optional with remote signaling contact (FM)
- Vibration and shock tested acc. to EN 60068-2

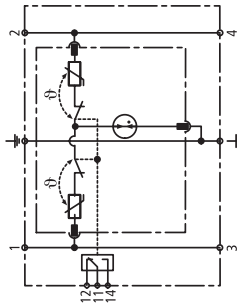

Type	Part No.	Part No.
wietap R M 2P 30 FM		84.995.3206.0
wietap R M 2P 255	84.995.3200.0	
wietap R M 2P 255 FM	84.995.3205.0	
SPD accord. to EN 61643-11 / IEC 61643-11	Type 3 / Class III	Type 3 / Class III
Nominal voltage AC [U _n]	230 V (50/60 Hz)	24 V (50/60 Hz)
Maximum continuous voltage AC [U _c]	255 V (50/60 Hz)	30 V (50/60 Hz)
Maximum continuous voltage DC [U _c]	255 V	30 V
Nominal load current AC [I _n]	25 A	25 A
Nominal discharge current (8/20) [I _n]	3 kA	1 kA
Total discharge current (8/20) [L+N-PE] [I _{total}]	5 kA	2 kA
Combined surge [U _{oc}]	6 kV	2 kV
Combined surge [L+N-PE] [U _{oc, total}]	10 kV	4 kV
Protection level [L-N] [U _p]	≤ 1250 V	≤ 180 V
Protection level [L/N-PE] [U _p]	≤ 1500 V	≤ 630 V
Operating time [L-N] [t _A]	≤ 25 ns	≤ 25 ns
Operating time [L/N-PE] [t _A]	≤ 100 ns	≤ 100 ns
Maximum network overcurrent protection	25 A gL/gG oder B 25 A	25 A gL/gG oder B 25 A
Short-circuit proof with network overcurrent protection with 25 A gL/gG	6 kA _{rms}	6 kA _{rms}
TOV-voltage		
[L-N] [U _T] – characteristic	335 V / 5 sec. – withstand	--
[L-N] [U _T] – characteristic	440 V / 120 min. – safe failure	
[L/N-PE] (I) [U _T] – characteristic	335 V / 120 min. – withstand	--
[L/N-PE] (I) [U _T] – characteristic	440 V / 5 sec. – withstand	
[L+N-PE] (II) [U _T] – characteristic	1200 V + U _{REF} / 200 ms – safe failure	--
Temperature range [T _U]	-40 ... +80 °C	
Function/failure indication	green / red	
Wire range min.	0.5 mm ² (AWG 20) solid/fine-stranded	
Wire range max.	4 mm ² (AWG 12) solid / 2.5 mm ² (AWG 14) fine-stranded	
Mounted on DIN rail acc. to EN 60715	35 mm	
Housing material	Thermoplast, UL 94 V-0	
Degree of protection	IP 20	
Dimensions	1 TE, DIN 43880 (18 mm)	
Remote signaling contacts = Contact Type	Change-over contact	
Switching capacity AC (FM)	250 V/0.5 A	
Switching capacity DC (FM)	250 V/0.1 A; 125 V/0.2 A; 75 V/0.5 A	
Wire range for Remote signaling terminals	max. 1.5 mm ² (AWG 16) solid/fine-stranded	
Approvals	CE	

Surge arrester, type 3

For direct load protection in control cabinets or sub-distributions

wietap R M 4P 255 (FM)

- Surge arrester, type 3
- Four-pole surge arrester
- High discharge capacity due to powerful zinc oxide varistor
- Slim design (modular construction) acc. to DIN 43880
- With pluggable protection modules
- Function/failure indication according to VDE 0100-534
- Optional with remote signaling contact (FM)
- Vibration and shock tested acc. to EN 60068-2

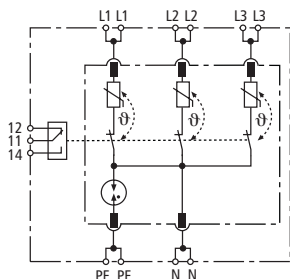

Type	Part No.
wietap R M 4P 255	84.995.3400.0
wietap R M 4P 255 FM	84.995.3405.0
Technical Data	
SPD accord. to EN 61643-11 / IEC 61643-11	Type 3 / Class III
Nominal voltage AC [U _N]	230 / 400 V (50/60 Hz)
Maximum continuous voltage AC [U _c]	255 / 440 V (50/60 Hz)
Nominal load current AC [I _L]	25 A
Nominal discharge current (8/20) [I _n]	3 kA
Total discharge current (8/20) [L+N-PE] [I _{total}]	8 kA
Combined surge [U _{oc}]	6 kV
Combined surge [L+N-PE] [U _{oc total}]	16 kV
Protection level [L-N] [U _p]	≤ 1000 V
Protection level [L/N-PE] [U _p]	≤ 1500 V
Operating time [L-N] [t _a]	≤ 25 ns
Operating time [L/N-PE] [t _a]	≤ 100 ns
Maximum network overcurrent protection	25 A gL/gG oder B 25 A
Short-circuit proof with network overcurrent protection with 25 A gL/gG	6 kA _{eff}
TOV-voltage [L-N] [U _T] – characteristic	335 V / 5 sec. – withstand
TOV-voltage [L-N] [U _T] – characteristic	440 V / 120 min. – safe failure
TOV-voltage [L/N-PE] (I) [U _T] – characteristic	335 V / 120 min. – withstand
TOV-voltage [L/N-PE] (II) [U _T] – characteristic	440 V / 5 sec. – withstand
TOV-voltage [N-PE] (II) [U _T] – characteristic	1200 V / 200 ms – safe failure
Temperature range [T _v]	-40 ... +80 °C
Function/failure indication	green / red
Wire range (min.)	0.5 mm ² (AWG 20) solid/fine-stranded
Wire range (max.)	4 mm ² (AWG 12) solid / 2.5 mm ² (AWG 14) fine-stranded
Mounted on DIN rail acc. to EN 60715	35 mm
Housingwerkstoff	Thermoplast, UL 94 V-0
Degree of protection	IP 20
Dimensions	2 TE, DIN 43880 (36 mm)
Remote signaling contacts = Contact Type	Change-over contact
Switching capacity AC (FM)	250 V/0.5 A
Switching capacity DC (FM)	250 V/0.1 A; 125 V/0.2 A; 75 V/0.5 A
Wire range for remote signaling terminals	max. 1.5 mm ² (AWG 16) solid/fine-stranded
Approvals	CE

wietap R M MOD 4P 255

- Replacement module for wietap R M 4P 255



Type	Part No.
wietap R M MOD 4P 255	84.995.3020.0

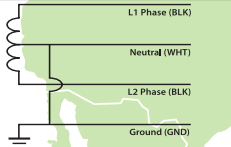
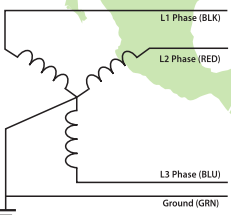
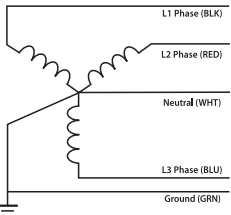
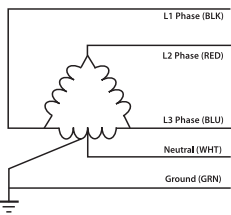
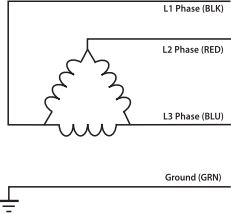
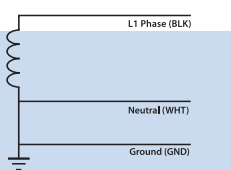
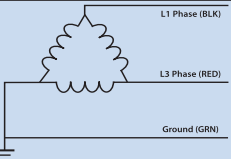

Solutions for Category B for the different mains systems: Selection Matrix

Circuit	Circuit Voltage Configuration	Used Types	Connected between
	120/240V Split Phase 1Ø 3W + Grnd	wietap G S 150 FM UL wietap G S 150 FM UL	L1 Phase-Grnd L2 Phase-Grnd
	240/480V Split Phase 1Ø 3W + Grnd	wietap G S 320 FM UL wietap G S 320 FM UL	L1 Phase-Grnd L2 Phase-Grnd
	127/254V Split Phase 1Ø 3W + Grnd	wietap G S 150 FM UL wietap G S 150 FM UL	L1 Phase-Grnd L2 Phase-Grnd
	120/208V Wye 3Ø 3W + Grnd	wietap G S 150 FM UL wietap G S 150 FM UL wietap G S 150 FM UL	L1 Phase-Grnd L2 Phase-Grnd L3 Phase-Grnd
	277/480V Wye 3Ø 3W + Grnd	wietap G S 320 FM UL wietap G S 320 FM UL wietap G S 320 FM UL	L1 Phase-Grnd L2 Phase-Grnd L3 Phase-Grnd
	347/600V Wye 3Ø 3W + Grnd	wietap G S 440 FM UL wietap G S 440 FM UL wietap G S 440 FM UL	L1 Phase-Grnd L2 Phase-Grnd L3 Phase-Grnd
	120/208V Wye 3Ø 4W + Grnd	wietap G S 150 FM UL wietap G S 150 FM UL wietap G S 150 FM UL	L1 Phase-Grnd L2 Phase-Grnd L3 Phase-Grnd Neutral-Grnd
	277/480V Wye 3Ø 4W + Grnd	wietap G S 320 FM UL wietap G S 320 FM UL wietap G S 320 FM UL	L1 Phase-Grnd L2 Phase-Grnd L3 Phase-Grnd Neutral-Grnd
	347/600V Wye 3Ø 4W + Grnd	wietap G S 440 FM UL wietap G S 440 FM UL wietap G S 440 FM UL	L1 Phase-Grnd L2 Phase-Grnd L3 Phase-Grnd Neutral-Grnd
	127/220V Wye 3Ø 4W + Grnd	wietap G S 150 FM UL wietap G S 150 FM UL wietap G S 150 FM UL wietap G S 150 FM UL	L1 Phase-Grnd L2 Phase-Grnd L3 Phase-Grnd Neutral-Grnd
	120/240V High Leg Delta - B High	wietap G S 150 FM UL wietap G S 150 FM UL wietap G S 150 FM UL wietap G S 275 FM UL	L1 Phase-Neutral L3 Phase-Neutral Neutral-Grnd L2 Phase-Neutral
	240/480V High Leg Delta - B High	wietap G S 320 FM UL wietap G S 320 FM UL wietap G S 320 FM UL wietap G S 600 FM UL	L1 Phase-Neutral L3 Phase-Neutral Neutral-Grnd L2 Phase-Neutral
	480V Delta 3Ø 3W + Grnd & HRG Wye	wietap G S 600 FM UL wietap G S 600 FM UL wietap G S 600 FM UL	L1 Phase-Grnd L2 Phase-Grnd L3 Phase-Grnd
	240V Delta 3Ø 3W + Grnd	wietap G S 320 FM UL wietap G S 320 FM UL wietap G S 320 FM UL	L1 Phase-Grnd L2 Phase-Grnd L3 Phase-Grnd
	600V Delta 3Ø 3W + Grnd & HRG	wietap G S WE 600 FM UL wietap G S WE 600 FM UL wietap G S WE 600 FM UL	L1 Phase-Grnd L2 Phase-Grnd L3 Phase-Grnd
	120V Single Phase	wietap G S 150 FM UL	L1 Phase-Neutral
	240V Single Phase	wietap G S 320 FM UL	L1 Phase-Neutral
	127V Single Phase	wietap G S 150 FM UL	L1 Phase-Neutral
	254V Single Phase	wietap G S 320 FM UL	L1 Phase-Neutral
	347V Single Phase	wietap G S 440 FM UL	L1 Phase-Neutral
	277V Single Phase	wietap G S 320 FM UL	L1 Phase-Neutral
	480V Single Phase	wietap G S 600 FM UL	L1 Phase-Neutral
600V Single Phase	wietap G S WE 600 FM UL	L1 Phase-Neutral	
	480V B Corner Grnd Delta 3Ø 3W + Grnd	wietap G S 600 FM UL wietap G S 600 FM UL	L1 Phase-Grnd L3 Phase-Grnd
	240V B Corner Grnd Delta 3Ø 3W + Grnd	wietap G S 320 FM UL wietap G S 320 FM UL	L1 Phase-Grnd L3 Phase-Grnd
	600V B Corner Grnd Delta 3Ø 3W + Grnd	wietap G S WE 600 FM UL wietap G S WE 600 FM UL	L1 Phase-Grnd L3 Phase-Grnd

Overvoltage Protection for **North and Central America**

For the North and Central American region OVP modules have to be used with UL or CSA approval. At the same time the voltage levels are different compared to Europe or the Asian region.

For this reason Wieland offers specialized OVP modules. The green marked countries have energy network systems according UL and CSA mains systems and voltage levels.

The overvoltage protection according IEEE is defined into 3 different areas:

- **Category C (Class I according IEC):** is mainly used at the feed in point of a building or production site. Mainly at outside termination
- **Category B (Class II according IEC):** this category is often used inside of buildings in main distribution panels or in switch board cabinets of machines
- **Category A (Class III according IEC):** is mainly used for the protection of single devices inside a switch board cabinet

Wieland is offering solutions for inside the building. This means for Category B and Category A.

At Category A applications the arrester is connected up front in series to the device.

The rated voltage of the OVP is selected according the nominal voltage of the device which is connected.

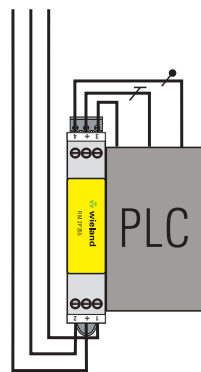

Category A

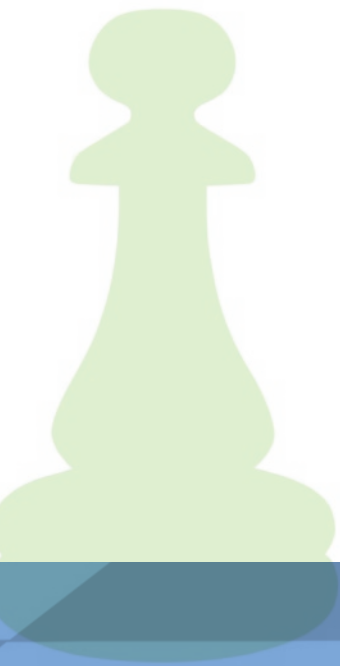

Single-phase surge arrester, category B & A

For protection of sub-distributions or the control cabinet main supply

wietap G S 150 FM UL wietap G S 275 FM UL

- Surge arrester, type 2, category B
- Multi-purpose surge arrester
- With plug-in protection module
- Thermo Dynamic Control SPD monitoring device
- Small housing
- Operating state/fault indication by indicator flag in window
- With signaling contact (FM)
- Vibration and shock tested according EN 60068-2

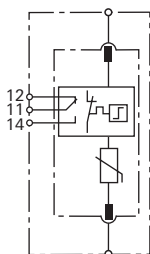

Type	Part No.	Part No.
wietap G S 150 FM UL	84.995.2092.1	
wietap G S 275 FM UL		84.995.2090.1
SPD accord. to EN 61643-11/IEC 61643-11	Type 2 / Cat. B / Class II	Type 2 / Cat. B / Class II
Rated voltage AC [U _n]	120 V (50 / 60 Hz)	230 V (50 / 60 Hz)
Maximum continuous voltage AC [U _c]	150 V (50 / 60 Hz)	275 V (50 / 60 Hz)
Maximum continuous voltage DC [U _c]	200 V	350 V
Rated discharge current [I _n]	15 kA	20 kA
Max. discharge current (8/20) [I _{max}]	40 kA	40 kA
Protection level [U _p]	≤ 0.7 kV	≤ 1.25 kV
Protection level at 5 kA [U _p]	≤ 0.55 kV	≤ 1 kV
Operating time [t _a]	≤ 25 ns	≤ 25 ns
Maximum network overcurrent protection	125 A gG	125 A gG
Short-circuit proof with max. network overcurrent protection	50 kA _{rms}	50 kA _{rms}
TOV-voltage [U _T] – characteristic	175 V/5 sec. – withstand	335 V/5 sec. – withstand
TOV-voltage [U _T] – characteristic	230 V/120 min. – safe failure	440 V/120 min. – safe failure
Temperature range [T _U] acc. to UL 1449 3rd edition acc. to EN 61643-11	0... +85 °C -40... +85 °C	
Function/failure indication	green / red	
Wire range (min.)	1.5 mm ² (AWG 14) solid/fine-stranded	
Wire range (max.)	35 mm ² (AWG 2) stranded / 25 mm ² (AWG 4) fine-stranded	
Mounted on DIN rail acc. to EN 60715	35 mm	
Housing material	thermoplastic, UL 94 V-0	
Degree of protection	IP 20	
Dimensions	1 mod., DIN 43880	
Remote signaling contacts (FM)	changeover contact	
Switching capacity AC (FM)	250 V/0.5 A	
Switching capacity DC (FM)	250 V/0.1 A; 125 V/0.2 A; 75 V/0.5 A	
Wire range for remote signaling terminals	max. 1.5 mm ² (AWG 14) solid/fine-stranded	
Approvals	CE, VDE, TÜV	

wietap G S 320 FM UL wietap G S 385 FM UL

- Surge arrester, type 2, category B
- Multi-purpose surge arrester
- With plug-in protection module
- Thermo Dynamic Control SPD monitoring device
- Small housing
- Operating state/fault indication by indicator flag in window
- With signaling contact (FM)
- Vibration and shock tested according EN 60068-2

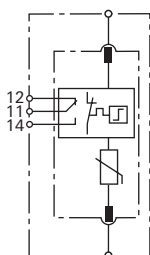

Type	Part No.	Part No.
wietap G S 320 FM UL	84.995.2093.1	
wietap G S 385 FM UL		84.995.2094.1
SPD accord. to EN 61643-11/IEC 61643-11	Type 2 / Cat. B / Class II	Type 2 / Cat. B / Class II
Rated voltage AC [U _n]	230 V (50 / 60 Hz)	230 V (50 / 60 Hz)
Maximum continuous voltage AC [U _c]	320 V (50 / 60 Hz)	385 V (50 / 60 Hz)
Maximum continuous voltage DC [U _c]	420 V	500 V
Rated discharge current [I _n]	20 kA	20 kA
Max. discharge current (8/20) [I _{max}]	40 kA	40 kA
Protection level [U _p]	≤ 1.5 kV	≤ 1.75 kV
Protection level at 5 kA [U _p]	≤ 1.2 kV	≤ 1.35 kV
Operating time [t _a]	≤ 25 ns	≤ 25 ns
Maximum network overcurrent protection	125 A gG	125 A gG
Short-circuit proof with max. network overcurrent protection	25 kA _{rms}	25 kA _{rms}
TOV-voltage [U _T] – characteristic	335 V/5 sec. – withstand	385 V/5 sec. – withstand
TOV-voltage [U _T] – characteristic	440 V/120 min. – safe failure	440 V/120 min. – safe failure
Temperature range [T _U] acc. to UL 1449 3rd edition acc. to EN 61643-11	0... +85 °C -40... +85 °C	
Function/failure indication	green / red	
Wire range (min.)	1.5 mm ² (AWG 14) solid/fine-stranded	
Wire range (max.)	35 mm ² (AWG 2) stranded / 25 mm ² (AWG 4) fine-stranded	
Mounted on DIN rail acc. to EN 60715	35 mm	
Housing material	thermoplastic, UL 94 V-0	
Degree of protection	IP 20	
Dimensions	1 mod., DIN 43880	
Remote signaling contacts (FM)	changeover contact	
Switching capacity AC (FM)	250 V/0.5 A	
Switching capacity DC (FM)	250 V/0.1 A; 125 V/0.2 A; 75 V/0.5 A	
Wire range for remote signaling terminals	max. 1.5 mm ² (AWG 14) solid/fine-stranded	
Approvals	CE, VDE, TÜV	

Single-phase surge arrester, category B & A

For protection of sub-distributions or the control cabinet main supply

wietap G S 440 FM UL wietap G S 600 FM UL

- Surge arrester, type 2, category B
- Multi-purpose surge arrester
- With plug-in protection module
- Thermo Dynamic Control SPD monitoring device
- Small housing
- Operating state/fault indication by indicator flag in window
- With signaling contact (FM)
- Vibration and shock tested according EN 60068-2

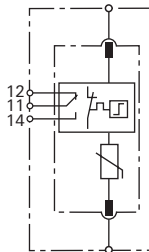

Type	Part No.	Part No.
wietap G S 440 FM UL	84.995.2095.1	
wietap G S 600 FM UL		84.995.2096.1
SPD accord. to EN 61643-11/IEC 61643-11	Type 2 / Cat. B / Class II	Type 2 / Cat. B / Class II
Rated voltage AC [U _n]	400 V (50 / 60 Hz)	480 V (50 / 60 Hz)
Maximum continuous voltage AC [U _c]	440 V (50 / 60 Hz)	600 V (50 / 60 Hz)
Maximum continuous voltage DC [U _c]	585 V	600 V
Rated discharge current [I _n]	20 kA	15 kA
Max. discharge current (8/20) [I _{max}]	40 kA	30 kA
Protection level [U _p]	≤ 2 kV	≤ 2.5 kV
Protection level at 5 kA [U _p]	≤ 1.7 kV	≤ 2 kV
Operating time [t _Δ]	≤ 25 ns	≤ 25 ns
Maximum network overcurrent protection	125 A gG	100 A gG
Short-circuit proof with max. network overcurrent protection	25 kA _{rms}	25 kA _{rms}
TOV-voltage [U _T] – characteristic	580 V / 5 sec. – withstand	700 V / 5 sec. – withstand
TOV-voltage [U _T] – characteristic	765 V / 120 min. – safe failure	915 V / 120 min. – safe failure
Temperature range [T _U] acc. to UL 1449 3rd edition acc. to EN 61643-11	0... +85 °C -40... +85 °C	
Function/failure indication	green / red	
Wire range (min.)	1.5 mm ² (AWG 14) solid/fine-stranded	
Wire range (max.)	35 mm ² (AWG 2) stranded / 25 mm ² (AWG 4) fine-stranded	
Mounted on DIN rail acc. to EN 60715	35 mm	
Housing material	thermoplastic, UL 94 V-0	
Degree of protection	IP 20	
Dimensions	1 mod., DIN 43880	
Remote signaling contacts (FM)	changeover contact	
Switching capacity AC (FM)	250 V/0.5 A	
Switching capacity DC (FM)	250 V/0.1 A; 125 V/0.2 A; 75 V/0.5 A	
Wire range for remote signaling terminals	max. 1.5 mm ² (AWG 14) solid/fine-stranded	
Approvals	CE	

wietap G S WE 600 FM UL

- Surge arrester, type 2, category B
- Multi-purpose surge arrester
- With plug-in protection module
- Thermo Dynamic Control SPD monitoring device
- Small housing
- Operating state/fault indication by indicator flag in window
- With signaling contact (FM)
- Vibration and shock tested according EN 60068-2

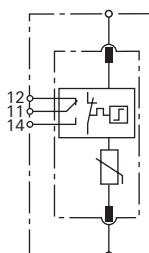

Type	Part No.	Part No.
wietap G S WE 600 FM UL	84.995.2097.1	
SPD accord. to EN 61643-11/IEC 61643-11	Type 2 / Category B / Class II	
Rated voltage AC [U _n]	480 V (50 / 60 Hz)	
Maximum continuous voltage AC [U _c]	600 V (50 / 60 Hz)	
Rated varistor voltage AC [U _{mov}]	750V	
Rated discharge current [I _n]	15 kA	
Max. discharge current (8/20) [I _{max}]	25 kA	
Protection level [U _p]	≤ 3 kV	
Protection level at 5 kA [U _p]	≤ 2.5 kV	
Operating time [t _Δ]	≤ 25 ns	
Maximum network overcurrent protection	100 A gL/gG	
Short-circuit proof with max. network overcurrent protection	25 kA _{rms}	
TOV-voltage [U _T] – characteristic	900 V / 5 sec. – withstand	
TOV-voltage [U _T] – characteristic	915 V / 120 min. – safe failure	
Temperature range [T _U] acc. to UL 1449 3rd edition acc. to EN 61643-11	0... +85 °C -40... +85 °C	
Function/failure indication	green / red	
Wire range (min.)	1.5 mm ² (AWG 14) solid/fine-stranded	
Wire range (max.)	35 mm ² (AWG 2) stranded / 25 mm ² (AWG 4) fine-stranded	
Mounted on DIN rail acc. to EN 60715	35 mm	
Housing material	thermoplastic, UL 94 V-0	
Degree of protection	IP 20	
Dimensions	1 mod., DIN 43880	
Remote signaling contacts (FM)	changeover contact	
Switching capacity AC (FM)	250 V/0.5 A	
Switching capacity DC (FM)	250 V/0.1 A; 125 V/0.2 A; 75 V/0.5 A	
Wire range for remote signaling terminals	max. 1.5 mm ² (AWG 14) solid/fine-stranded	
Approvals	CE	

Surge arrester, category A

For direct load protection in control cabinets or sub-distributions

wietap R M 2P 30 FM

- Surge arrester, type 3
- Two-pole surge arrester
- High discharge capacity due to powerful zinc oxide varistor
- Slim design (modular construction) acc. to DIN 43880
- With pluggable protection modules
- Function/failure indication according to VDE 0100-534
- With remote signaling contact (FM)
- Vibration and shock tested acc. to EN 60068-2

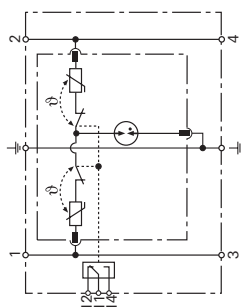

Type	Part No.
wietap R M 2P 30 FM	84.995.3206.0
Technical Data	
SPD accord. to EN 61643-11 / IEC 61643-11	Type 3 / Category A / Class III
Rated voltage AC [U _N]	24 V (50 / 60 Hz)
Maximum continuous voltage AC [U _C]	30 V (50 / 60 Hz)
Maximum continuous voltage DC [U _C]	30 V
Rated current AC [I _N]	25 A
Rated discharge current (8/20) [I _N]	1 kA
Total discharge current (8/20) [L+N-PE] [I _{total}]	2 kA
Combined surge [U _{OC}]	2 kV
Combined surge [L+N-PE] [U _{OC total}]	4 kV
Protection level [L-N] [U _F]	≤ 180 V
Protection level [L/N-PE] [U _F]	≤ 630 V
Operating time [L-N] [t _A]	≤ 25 ns
Operating time [L/N-PE] [t _A]	≤ 100 ns
Maximum network overcurrent protection	25 A gL/gG or B 25 A
Short-circuit proof with network overcurrent protection with 25 A gL/gG	6 kA _{rms}
Temperature range [T _U] acc. to UL 1449 3rd edition acc. to EN 61643-11	0... +85 °C -40... +85 °C
Function/failure indication	green / red
Wire range (min.)	0.5 mm ² (AWG 20) solid/fine-stranded
Wire range (max.)	4 mm ² (AWG 12) solid / 2.5 mm ² (AWG 14) fine-stranded
Mounted on DIN rail acc. to EN 60715	35 mm
Housing material	thermoplastic, UL 94 V-0
Degree of protection	IP 20
Dimensions	1 mod., DIN 43880
Remote signaling contacts (FM)	changeover contact
Switching capacity AC (FM)	250 V/0.5 A
Switching capacity DC (FM)	250 V/0.1 A; 125 V/0.2 A; 75 V/0.5 A
Wire range for remote signaling terminals	max. 1.5 mm ² (AWG 16) solid/fine-stranded
Approvals	CE, VDE, TÜV

wietap R M 2P 150 FM

- Surge arrester, type 3
- Two-pole surge arrester
- High discharge capacity due to powerful zinc oxide varistor
- Slim design (modular construction) acc. to DIN 43880
- With pluggable protection modules
- Function/failure indication according to VDE 0100-534
- With remote signaling contact (FM)
- Vibration and shock tested acc. to EN 60068-2

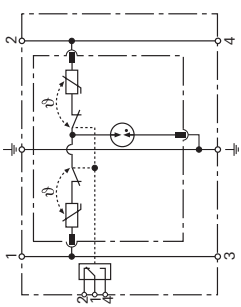

Type	Part No.
wietap R M 2P 150 FM	84.995.3209.0
Technical Data	
SPD accord. to EN 61643-11 / IEC 61643-11	Type 3 / Category A / Class III
Rated voltage AC [U _N]	120 V (50/60 Hz)
Maximum continuous voltage AC [U _C]	150 V (50/60 Hz)
Maximum continuous voltage DC [U _C]	150 V
Rated current AC [I _N]	25 A
Rated discharge current (8/20) [I _N]	2 kA
Total discharge current (8/20) [L+N-PE] [I _{total}]	4 kA
Combined surge [U _{OC}]	4 kV
Combined surge [L+N-PE] [U _{OC total}]	8 kV
Protection level [L-N] [U _F]	≤ 640 V
Protection level [L/N-PE] [U _F]	≤ 800 V
Operating time [L-N] [t _A]	≤ 25 ns
Operating time [L/N-PE] [t _A]	≤ 100 ns
Maximum network overcurrent protection	25 A gL/gG or B 25 A
Short-circuit proof with network overcurrent protection with 25 A gL/gG	6 kA _{rms}
Temperature range [T _U] acc. to UL 1449 3rd edition acc. to EN 61643-11	0... +85 °C -40... +85 °C
Function/failure indication	green / red
Wire range (min.)	0.5 mm ² (AWG 20) solid/fine-stranded
Wire range (max.)	4 mm ² (AWG 12) solid / 2.5 mm ² (AWG 14) fine-stranded
Mounted on DIN rail acc. to EN 60715	35 mm
Housing material	thermoplastic, UL 94 V-0
Degree of protection	IP 20
Dimensions	1 mod., DIN 43880
Remote signaling contacts (FM)	changeover contact
Switching capacity AC (FM)	250 V/0.5 A
Switching capacity DC (FM)	250 V/0.1 A; 125 V/0.2 A; 75 V/0.5 A
Wire range for remote signaling terminals	max. 1.5 mm ² (AWG 14) solid/fine-stranded
Approvals	CE, VDE, TÜV

Surge arrester, category A

For direct load protection in control cabinets or sub-distributions

wietap R M 2P 255

- Surge arrester, type 3
- Two-pole surge arrester
- High discharge capacity due to powerful zinc oxide varistor
- Slim design (modular construction) acc. to DIN 43880
- With pluggable protection modules
- Function/failure indication according to VDE 0100-534
- Vibration and shock tested acc. to EN 60068-2

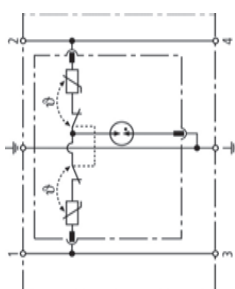

Type	Part No.
wietap R M 2P 255	84.995.3200.0
Technical Data	
SPD accord. to EN 61643-11 / IEC 61643-11	Type 3 / Category A / Class III
Rated voltage AC [U _N]	230 V (50 / 60 Hz)
Maximum continuous voltage AC [U _C]	255 V (50 / 60 Hz)
Maximum continuous voltage DC [U _C]	255 V
Rated current AC [I _L]	20 A
Rated discharge current (8/20) [I _n]	3 kA
Total discharge current (8/20) [L+N-PE] [I _{total}]	5 kA
Combined surge [U _{OC}]	6 kV
Combined surge [L+N-PE] [U _{OC total}]	10 kV
Protection level [L-N] [U _P]	≤ 1250 V
Protection level [L/N-PE] [U _P]	≤ 1500 V
Operating time [L-N] [t _A]	≤ 25 ns
Operating time [L/N-PE] [t _A]	≤ 100 ns
Maximum network overcurrent protection	25 A gL/gG or B 25 A
Short-circuit proof with network overcurrent protection with 25 A gL/gG	6 kA _{rms}
TOV-voltage [L-N] [U _T] – characteristic	335 V / 5 sec. – withstand
TOV-voltage [L-N] [U _T] – characteristic	440 V / 120 min. – safe failure
TOV-voltage [L/N-PE] (I) [U _T] – characteristic	335 V / 120 min. – withstand
TOV-voltage [L/N-PE] (I) [U _T] – characteristic	440 V / 5 sec. – withstand
TOV-voltage [L+N-PE] (II) [U _T] – characteristic	1200 V + U _{REF} / 200 ms – safe failure
Temperature range [T _U] acc. to UL 1449 3rd edition acc. to EN 61643-11	0... +85 °C -40... +85 °C
Function/failure indication	green / red
Wire range (min.)	0.5 mm ² (AWG 20) solid/fine-stranded
Wire range (max.)	4 mm ² (AWG 12) solid / 2.5 mm ² (AWG 14) fine-stranded
Mounted on DIN rail acc. to EN 60715	35 mm
Housing material	thermoplastic, UL 94 V-0
Degree of protection	IP 20
Dimensions	1 mod., DIN 43880
Approvals	CE

wietap R M 2P 255 FM

- Surge arrester, type 3
- Two-pole surge arrester
- High discharge capacity due to powerful zinc oxide varistor
- Slim design (modular construction) acc. to DIN 43880
- With pluggable protection modules
- Function/failure indication according to VDE 0100-534
- With remote signaling contact (FM)
- Vibration and shock tested acc. to EN 60068-2

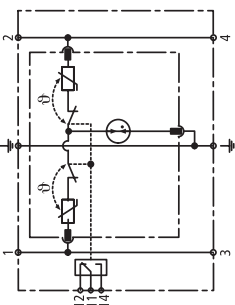

Type	Part No.
wietap R M 2P 255 FM	84.995.3205.0
Technical Data	
SPD accord. to EN 61643-11 / IEC 61643-11	Type 3 / Category A / Class III
Rated voltage AC [U _N]	230 V (50 / 60 Hz)
Maximum continuous voltage AC [U _C]	255 V (50 / 60 Hz)
Maximum continuous voltage DC [U _C]	255 V
Rated current AC [I _L]	25 A
Rated discharge current (8/20) [I _n]	3 kA
Total discharge current (8/20) [L+N-PE] [I _{total}]	5 kA
Combined surge [U _{OC}]	6 kV
Combined surge [L+N-PE] [U _{OC total}]	10 kV
Protection level [L-N] [U _P]	≤ 1250 V
Protection level [L/N-PE] [U _P]	≤ 1500 V
Operating time [L-N] [t _A]	≤ 25 ns
Operating time [L/N-PE] [t _A]	≤ 100 ns
Maximum network overcurrent protection	25 A gL/gG or B 25 A
Short-circuit proof with network overcurrent protection with 25 A gL/gG	6 kA _{rms}
TOV-voltage [L-N] [U _T] – characteristic	335 V / 5 sec. – withstand
TOV-voltage [L-N] [U _T] – characteristic	440 V / 120 min. – safe failure
TOV-voltage [L/N-PE] (I) [U _T] – characteristic	335 V / 120 min. – withstand
TOV-voltage [L/N-PE] (I) [U _T] – characteristic	440 V / 5 sec. – withstand
TOV-voltage [L+N-PE] (II) [U _T] – characteristic	1200 V + U _{REF} / 200 ms – safe failure
Temperature range [T _U] acc. to UL 1449 3rd edition acc. to EN 61643-11	0... +85 °C -40... +85 °C
Function/failure indication	green / red
Wire range (min.)	0.5 mm ² (AWG 20) solid/fine-stranded
Wire range (max.)	4 mm ² (AWG 12) solid / 2.5 mm ² (AWG 14) fine-stranded
Mounted on DIN rail acc. to EN 60715	35 mm
Housing material	thermoplastic, UL 94 V-0
Degree of protection	IP 20
Dimensions	1 mod., DIN 43880
Remote signaling contacts (FM)	changeover contact
Switching capacity AC (FM)	250 V/0.5 A
Switching capacity DC (FM)	250 V/0.1 A; 125 V/0.2 A; 75 V/0.5 A
Wire range for remote signaling terminals	max. 1.5 mm ² (AWG 16) solid/fine-stranded
Approvals	CE

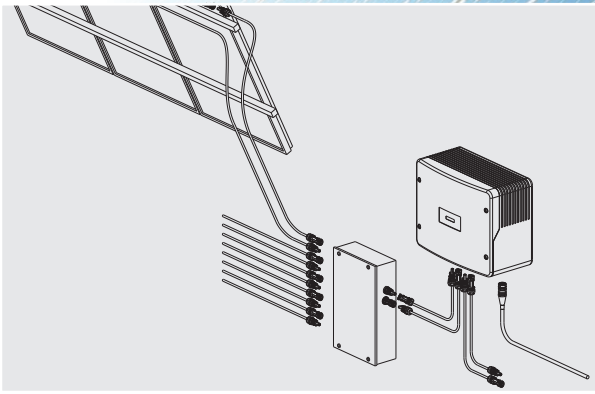
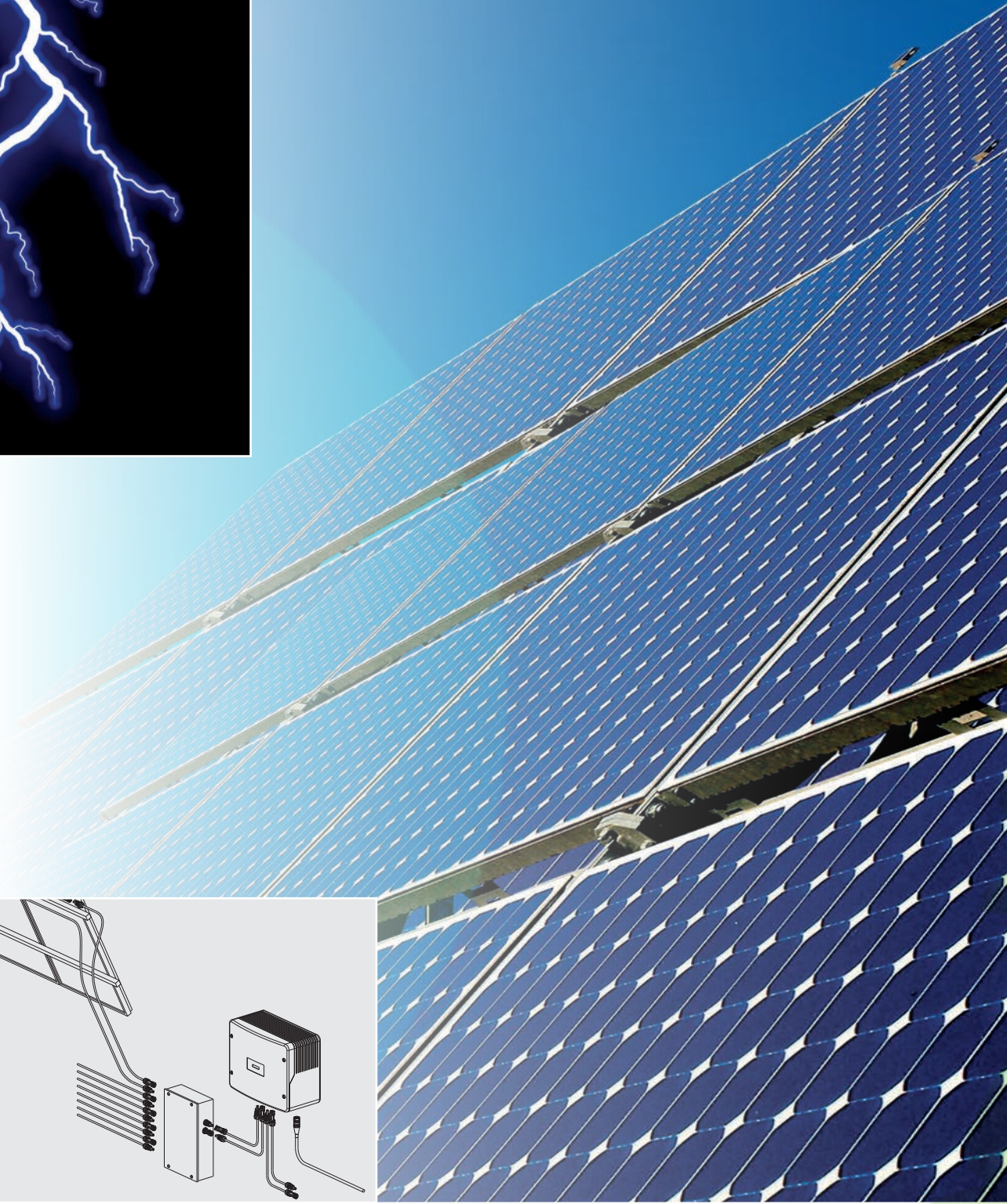

Overvoltage protection for Photovoltaic systems

Photovoltaic systems, abbreviated as PV systems, are a considerable investment that must be protected from failure and damage. As these systems are installed outdoors, they are exposed to the danger of overvoltage from lightning strikes.

Overvoltage protection in the DC circuit with central inverters

The generator circuit (the PV modules) produces a direct current. Connecting the PV modules and arrays in series allows voltages of 1000 V to be reached. This combination with the fact that the generator circuit can continue to supply energy after overvoltage requires sophisticated technology for the overvoltage arrester.

DC overvoltage protection:

The PV/DC overvoltage arresters are specially designed for use in PV systems.

Both the housing technology and the connections are designed for the requirements of a PV systems high voltages and conductor cross-sections. With a width of only 36 or 48mm, the units are easily installed inside distribution panels, requiring the minimum of space.

- High discharge capacity due to powerful zinc-oxide varistor
- No fire hazard caused by permanent electric arc due to combined disconnect and short-circuit facility. Overload indicated in display window
- Signaling contacts for remote monitoring in all remote signaling types

AC overvoltage protection:

On the AC side of the inverters overvoltage protection must also be installed. The arresters listed here are the most commonly used versions.

Suitable units can be found inside the chapters **wietap** IEC and **wietap** UL/CSA.



Surge protection for solar modules

To be used in photovoltaic DC circuits

wietap GS PV SCI 600 (FM)

- DC solar arrester for 600 V string voltage
- For DC grounded solar systems
- No fire hazard during overload due to combined disconnection and short-circuit device
- Safe, arc-free replacement of protection modules due to integrated DC fuse
- High discharge capacity
- Function/failure indication
- **wietap** GS PV SCI 600 FM with remote signaling contact (FM)

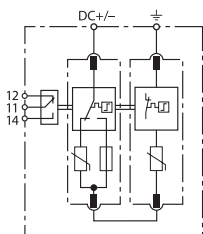

Type	Part No.
wietap GS PV SCI 600	84.995.2550.0
wietap GS PV SCI 600 FM	84.995.2555.0

Technical Data	
Connection between	DC – Grnd
SPD accord. to EN 50539-11	Type 2
Maximum PV voltage [U _{CPV}]	≤ 600 V
Short-circuit resistance (I _{SCPV})	1 kA
Nominal discharge current (8/20) [(DC+/DC-) → PE] [I _n]	12.5 kA
Max. discharge current (8/20) [(DC+/DC-) → PE] [I _{max}]	25 kA
Protection level [U _p]	≤ 2.5 kV
Protection level at 5 kA [U _p]	≤ 2 kV
Operating time [t _A]	≤ 25 ns
Temperature range [T _U]	-40 ... +80 °C
Function/failure indication	green / red
Wire range (min.)	1.5 mm ² (AWG 14) solid/fine-stranded
Wire range (max.)	35 mm ² (AWG 2) stranded / 25 mm ² (AWG 4) fine-stranded
Mounted on DIN rail acc. to EN 60715	35 mm
Housing material	Thermoplast, UL 94 V-0
Degree of protection	IP 20
Dimensions	2 TE, DIN 43880 (36 mm)
Remote signaling contacts (FM)	Change-over contact
Switching capacity AC (FM)	250 V/0.5 A
Switching capacity DC (FM)	250 V/0.1 A; 125 V/0.2 A; 75 V/0.5 A
Wire range for remote signaling terminals	max. 1.5 mm ² (AWG 14) solid/fine-stranded
Approvals	CE, TÜV, VDE

Surge protection for solar modules

To be used in photovoltaic DC circuits

wietap GM YPV SCI 600 (FM)

- DC solar arrester for 600 V string voltage
- No fire hazard during overload due to combined disconnection and short-circuit device
- Safe, arc-free replacement of protection modules due to integrated DC fuse
- High discharge capacity
- Function/failure indication
- **wietap** GM YPV SCI 600 FM with remote signaling contact (FM)

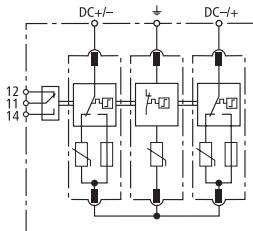

Type	Part No.
wietap GM YPV SCI 600	84.995.2511.0
wietap GM YPV SCI 600 FM	84.995.2516.0
Repl. module "+" or "-" against int. neutral point	84.995.2053.0
Repl. module int. neutral point against \perp	84.995.2010.0

Technical Data

Connection between	DC+ – Grnd – DC-
SPD accord. to EN 50539-11	Type 2
Maximum PV voltage [U _{CPV}]	≤ 600 V
Short-circuit resistance (I _{SCPV})	1 kA
Total discharge current (8/20) [I _{total}]	40 kA
Nominal discharge current (8/20) [(DC+/DC-) → PE] [I _n]	12.5 kA
Max. discharge current (8/20) [(DC+/DC-) → PE] [I _{max}]	25 kA
Protection level [U _P]	≤ 2.5 kV
Protection level at 5 kA [U _P]	≤ 2 kV
Operating time [t _A]	≤ 25 ns
Temperature range [T _U]	-40 ... +80 °C
Function/failure indication	green / red
Wire range (min.)	1.5 mm ² (AWG 14) solid/fine-stranded
Wire range (max.)	35 mm ² (AWG 2) stranded / 25 mm ² (AWG 4) fine-stranded
Mounted on DIN rail acc. to EN 60715	35 mm
Housing material	Thermoplast, UL 94 V-0
Degree of protection	IP 20
Dimensions	3 TE, DIN 43880 (54 mm)
Remote signaling contacts (FM)	Change-over contact
Switching capacity AC (FM)	250 V/0.5 A
Switching capacity DC (FM)	250 V/0.1 A; 125 V/0.2 A; 75 V/0.5 A
Wire range for remote signaling terminals	max. 1.5 mm ² (AWG 14) solid/fine-stranded
Approvals	CE

Replacement module for wietap GM YPV SCI 600 (FM)

wietap G MOD PV SCI 300

"+" or "-" against internal neutral point

wietap G MOD PV 300

Internal neutral point against PE

Type	Part No.
wietap G MOD PV SCI 300	84.995.2053.0
wietap G MOD PV 300	84.995.2043.0

Surge protection for solar modules

To be used in photovoltaic DC circuits

wietap GM YPV SCI 1000 (FM)

- DC solar arrester for 1000 V string voltage
- No fire hazard during overload due to combined disconnection and short-circuit device
- Safe, arc-free replacement of protection modules due to integrated DC fuse
- High discharge capacity
- Function/failure indication
- **wietap** GM YPV SCI 1000 FM with remote signaling contact (FM)

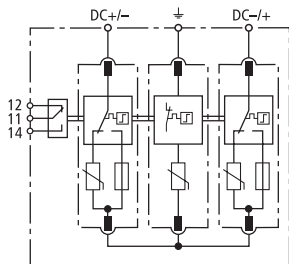

Type	Part No.
wietap GM YPV SCI 1000	84.995.2510.0
wietap GM YPV SCI 1000 FM	84.995.2515.0
Repl. module "+" or "-" against int. neutral point	84.995.2051.0
Repl. module int. neutral point against PE	84.995.2015.0
Technical Data	
Connection between	DC+ – Grnd – DC-
SPD accord. to EN 50539-11	Type 2
Maximum PV voltage [U _{CPV}]	≤ 1000 V
Short-circuit resistance [I _{SCPV}]	1 kA
Total discharge current (8/20) [I _{total}]	40 kA
Nominal discharge current (8/20) [(DC+/DC-) → PE] [I _n]	12.5 kA
Max. discharge current (8/20) [(DC+/DC-) → PE] [I _{max}]	25 kA
Protection level [U _p]	≤ 4 kV
Protection level at 5 kA [U _p]	≤ 3.5 kV
Operating time [t _A]	≤ 25 ns
Temperature range [T _U]	-40 ... +80 °C
Function/failure indication	green / red
Wire range (min.)	1.5 mm ² (AWG 14) solid/fine-stranded
Wire range (max.)	35 mm ² (AWG 2) stranded / 25 mm ² (AWG 4) fine-stranded
Mounted on DIN rail acc. to EN 60715	35 mm
Housing material	Thermoplast, UL 94 V-0
Degree of protection	IP 20
Dimensions	3 TE, DIN 43880 (54 mm)
Remote signaling contacts (FM)	Change-over contact
Switching capacity AC (FM)	250 V/0.5 A
Switching capacity DC (FM)	250 V/0.1 A; 125 V/0.2 A; 75 V/0.5 A
Wire range for remote signaling terminals	max. 1.5 mm ² (AWG 14) solid/fine-stranded
Approvals	CE, TÜV, VDE

Replacement module for wietap GM YPV SCI 1000 (FM)

wietap G MOD PV SCI 500

"+" or "-" against internal neutral point

wietap G MOD PV 500

Internal neutral point against PE

Type	Part No.
wietap G MOD PV SCI 500	84.995.2051.0
wietap G MOD PV 500	84.995.2041.0

Surge protection for solar modules

To be used in photovoltaic DC circuits

AC arrester on mains for Class 1/2/3



The used arrester type of the AC side is depending on the mains system.

A suitable arrester with the relevant certifications can be found in the previous chapters.

The suitable distribution for your project



AC combiner box

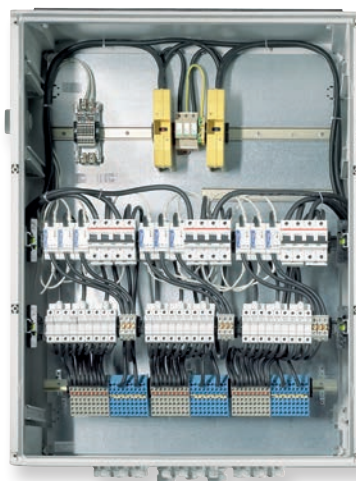

DC combiner box

Housing

Protection	Class II
UV-resistant	yes
Material	polycarbonate
Cable connection	pluggable or gland

Build in components

- Termination points for solar connectors
- Big termination points for inverter connection
- PE connection
- String fusing
- Reverse current diodes
- String monitoring
- Main switch
- Circuit breaker
- Overvoltage protection and many more



Wieland will support you during the planning phase.
High product quality and documentation are a standard for us.

Hotline: +49 951 9324-996 / e-mail: BIT.TS@wieland-electric.com

Part number | page

80.010.0005.0	52	80.010.6032.2	49	81.000.6550.0	42	83.036.3300.0	67
80.010.0007.0	52	80.010.6032.3	49	81.000.6560.0	43	83.036.4200.0	67
80.010.0008.0	52	80.010.6102.2	49	81.000.6570.0	43	83.036.4210.0	67
80.010.0009.0	52	80.010.6102.3	49	81.000.6580.0	43	83.036.4240.0	67
80.010.0010.0	52	80.010.6132.2	49	81.000.6590.0	43	83.036.4261.0	67
80.010.0011.0	51	80.010.6132.3	49	81.020.0000.0	73	83.036.5200.0	67
80.010.1002.0	52	80.020.0004.0	53	81.020.0001.0	73	83.036.5210.0	67
80.010.1003.0	52	80.020.2001.0	53	81.020.0002.0	73	83.036.5220.0	67
80.010.1100.0	51	80.020.2004.0	53	81.020.0003.0	73	83.040.0000.0	12
80.010.1102.0	51	80.020.4100.0	53	81.020.0010.0	74	83.040.0000.1	13
80.010.1104.0	51	80.020.4101.0	53	81.020.0011.0	73	83.040.0001.0	13
80.010.1106.0	51	80.020.4102.0	53	81.020.0020.0	75	83.040.0002.0	15
80.010.1108.0	51	80.020.4103.0	53	81.020.0021.0	75	83.040.0003.0	15
80.010.1110.0	51	80.020.4150.0	53	81.020.0025.0	75	83.040.0050.0	21
80.010.1112.0	51	80.063.4029.1	48	81.020.0100.0	73	83.040.0051.0	21
80.010.1114.0	51	80.063.4129.3	48	81.020.0104.0	73	83.040.0103.0	14
80.010.1116.0	51	80.063.5029.2	48	81.020.0105.0	73	83.040.0106.0	14
80.010.4000.0	50	80.063.5029.2	49	81.020.0134.0	73	83.040.1001.0	12
80.010.4005.0	50	80.063.5029.3	48	81.020.0135.0	73	83.040.1203.0	17
80.010.4100.0	50	80.063.6029.3	49	81.020.4100.0	74	83.040.1334.0	19
80.010.4101.0	50	80.063.6029.3	49	81.030.0020.1	81	83.041.0040.1	26
80.010.4103.0	50	81.000.6110.0	38	81.030.0021.1	81	83.041.0041.1	26
80.010.4105.0	50	81.000.6120.0	38	81.030.0100.0	80	83.041.0042.1	26
80.010.4106.0	50	81.000.6130.0	38	81.030.0101.0	80	83.041.0043.1	26
80.010.4120.0	50	81.000.6132.0	39	81.030.0110.0	80	83.041.0044.1	26
80.010.4131.0	50	81.000.6134.0	39	81.030.0111.0	80	83.041.0045.1	26
80.010.4141.0	50	81.000.6135.0	38	82.003.0110.0	58	83.041.0050.1	25
80.010.4501.0	48	81.000.6140.0	38	82.003.0120.0	58	83.041.0051.1	25
80.010.4501.1	48	81.000.6142.0	39	82.003.0130.0	58	83.041.0052.1	25
80.010.4502.0	48	81.000.6150.0	38	82.003.0200.0	59	83.041.0053.1	25
80.010.4502.1	48	81.000.6160.0	40	82.003.0201.0	59	83.041.0054.1	25
80.010.4521.0	48	81.000.6170.0	40	82.003.0210.0	59	83.041.0055.1	25
80.010.4521.1	48	81.000.6180.0	40	82.003.0250.0	59	83.041.0200.0	30
80.010.4522.0	48	81.000.6190.0	40	83.036.0000.0	66	83.041.0210.0	30
80.010.4522.1	48	81.000.6200.0	41	83.036.0010.0	66	83.041.0400.1	26
80.010.4525.0	48	81.000.6210.0	41	83.036.0020.0	66	83.041.0401.1	26
80.010.4525.1	48	81.000.6220.0	41	83.036.0030.0	66	83.041.0402.1	26
80.010.4526.0	48	81.000.6300.0	44	83.036.0040.0	66	83.041.0403.1	26
80.010.4526.1	48	81.000.6302.0	44	83.036.1000.0	64	83.041.0404.1	26
80.010.4622.0	48	81.000.6310.0	44	83.036.1010.0	65	83.041.0405.1	26
80.010.4901.3	48	81.000.6320.0	45	83.036.1020.0	64	83.041.0405.3	26
80.010.4902.3	48	81.000.6321.0	44	83.036.1040.0	64	83.041.0411.1	26
80.010.4912.3	48	81.000.6322.0	44	83.036.1050.0	65	83.041.0412.1	26
80.010.4915.3	48	81.000.6330.0	45	83.036.1060.0	65	83.041.0413.1	26
80.010.4916.3	48	81.000.6331.0	44	83.036.2100.0	66	83.041.0414.1	26
80.010.5101.2	48	81.000.6332.0	45	83.036.2200.0	66	83.041.0415.1	26
80.010.5102.2	48	81.000.6340.0	45	83.036.2300.0	66	83.041.0422.1	26
80.010.5315.2	48	81.000.6342.0	45	83.036.3100.0	67	83.041.0423.1	26
80.010.5316.2	48	81.000.6510.0	42	83.036.3110.0	67	83.041.0424.1	26
80.010.5702.2	49	81.000.6520.0	42	83.036.3150.0	67	83.041.0425.1	26
80.010.6002.2	49	81.000.6530.0	42	83.036.3200.0	67	83.041.0460.1	26
80.010.6002.3	49	81.000.6540.0	42	83.036.3210.0	67	83.041.0461.1	26

83.041.0462.1	26	84.995.0120.0	90	84.995.2555.0	106	Z8.000.0103.4	53
83.041.0463.1	26	84.995.0222.0	90	84.995.3020.0	97	Z8.000.0176.2	51
83.041.0464.1	26	84.995.1001.0	88	84.995.3200.0	96	Z8.000.0181.0	51
83.041.0465.1	26	84.995.1001.0	88	84.995.3200.0	103	Z8.000.0200.8	50
83.041.0465.3	26	84.995.1001.0	89	84.995.3205.0	96	Z8.000.0200.8	53
83.041.0499.1	26	84.995.1001.0	89	84.995.3205.0	103	Z8.000.0200.8	53
83.041.0500.1	25	84.995.1100.0	89	84.995.3206.0	96	Z8.000.0202.1	50
83.041.0501.1	25	84.995.1100.0	89	84.995.3206.0	102	Z8.000.0202.2	50
83.041.0502.1	25	84.995.1300.0	88	84.995.3209.0	102	Z8.000.0202.3	50
83.041.0503.1	25	84.995.1305.0	88	84.995.3400.0	97	Z8.000.0202.4	50
83.041.0504.1	25	84.995.1310.0	89	84.995.3405.0	97	ZD.000.0011.0	34
83.041.0505.1	25	84.995.1315.0	89	87.200.2200.3	54	ZD.000.0011.1	34
83.041.0505.3	25	84.995.1400.0	88	87.200.2201.3	54	ZD.000.0012.0	34
83.041.0511.1	25	84.995.1405.0	88	87.200.2202.3	54	ZD.000.0015.0	34
83.041.0512.1	25	84.995.2010.0	92	87.200.2203.3	54	ZD.000.0016.0	34
83.041.0513.1	25	84.995.2010.0	92	87.200.2205.3	54	ZD.000.0017.0	35
83.041.0514.1	25	84.995.2010.0	93	87.200.2206.3	54		
83.041.0515.1	25	84.995.2010.0	93	87.200.2207.3	54		
83.041.0522.1	25	84.995.2010.0	94	87.200.2208.3	54		
83.041.0523.1	25	84.995.2010.0	107	87.220.1853.0	51		
83.041.0524.1	25	84.995.2015.0	108	87.220.1953.3	51		
83.041.0525.1	25	84.995.2030.0	95	87.220.2253.3	51		
83.041.0560.1	25	84.995.2035.0	95	87.220.4753.3	51		
83.041.0561.1	25	84.995.2041.0	108	87.220.4853.3	51		
83.041.0562.1	25	84.995.2043.0	107	87.220.7553.0	51		
83.041.0563.1	25	84.995.2050.0	93	87.221.5553.0	51		
83.041.0564.1	25	84.995.2050.0	93	F0.000.0031.8	31		
83.041.0565.1	25	84.995.2051.0	108	F0.000.0031.9	73		
83.041.0565.3	25	84.995.2051.0	108	F0.000.0035.1	29		
83.041.0599.1	25	84.995.2053.0	107	F0.000.0035.2	29		
83.041.0605.1	28	84.995.2053.0	107	F0.000.0036.1	29		
83.041.0605.3	28	84.995.2060.0	95	F0.000.0036.2	29		
83.041.0615.1	28	84.995.2070.0	94	F0.000.0036.7	30		
83.041.0625.1	28	84.995.2090.0	94	F0.000.0037.3	31		
83.041.0635.1	28	84.995.2090.1	100	F0.000.0037.4	21		
83.041.0660.1	28	84.995.2092.1	100	F0.000.0037.4	30		
83.041.0661.1	28	84.995.2093.1	100	F0.000.0037.5	21		
83.041.0662.1	28	84.995.2094.1	100	F0.000.0037.5	30		
83.041.0663.1	28	84.995.2095.1	101	F0.000.0037.6	29		
83.041.0664.1	28	84.995.2096.1	101	F0.000.0037.7	31		
83.041.0665.1	28	84.995.2097.1	101	F0.000.0037.8	29		
83.041.0665.3	28	84.995.2300.0	92	F0.000.0037.9	31		
83.041.0700.1	24	84.995.2305.0	92	F0.000.0038.0	31		
83.041.0701.1	24	84.995.2310.0	93	Z4.242.5153.0	50		
83.041.0702.1	24	84.995.2315.0	93	Z4.242.5153.0	53		
83.041.0709.1	24	84.995.2400.0	92	Z4.242.5153.0	53		
83.041.0760.1	24	84.995.2405.0	92	Z8.000.0035.5	51		
83.041.0762.1	24	84.995.2510.0	108	Z8.000.0056.9	51		
83.041.0769.1	24	84.995.2511.0	107	Z8.000.0103.4	52		
83.041.0809.1	27	84.995.2515.0	108	Z8.000.0103.4	52		
83.041.0869.1	27	84.995.2516.0	107	Z8.000.0103.4	52		
84.995.0055.0	91	84.995.2550.0	106	Z8.000.0103.4	53		



Selection of our catalogs



0670.1 gesis®
Pluggable electrical installation
for indoors



0690.1 RST®
Pluggable electrical installation
in highest protection (IP6X)



0700.1 gesis® ELECTRONIC
Decentralized building
automation with plug & play



0500.1 selos / fasis
DIN Rail Terminal Blocks

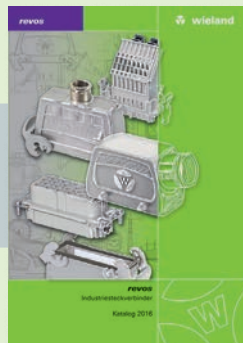

0530.1 revos
Industrial Multipole Connectors



0860.1 safety
System Solutions for
Automation Technology



0415.1 Machine building
Individual customer solutions



0416.1 Lift Technology
Solutions for the electrical installation



0430.1 Wind power
Electro-technical solutions
for wind energy systems



0910.1 Corporate Sustainability
Environmental Statement

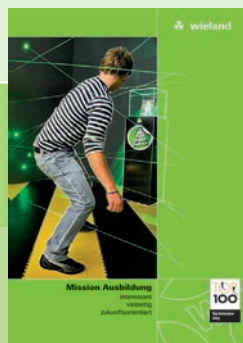

0912.0 Mission Ausbildung
interessant, vielseitig,
zukunftsorientiert



0901.1 Product Range
Solutions for industrial, building
and installation technology



0701.1 **gesis** FLEX
Decentralized room automation

Building and installation technology

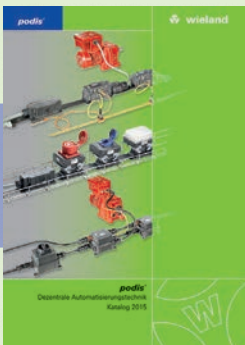

0830.1 **podis**[®]
Decentralized Automation

Industry and automation technology



0407.1 **Light**
Solutions for the electrical connection of luminaires



0417.1 **Shop fitting**
Pluggable electrical installation

Industries



0950.1 **Wieland Image brochure**



0004.2 **Wieland connects**
100 years in Bamberg.

Wieland



Technical consultation and general information

Hotline – one call is all it takes

Industrial Automation – Electromechanical

Hotline **+49 951 9324-991**
E-Mail **AT.TS@wieland-electric.com**

Building and Installation Technology

Hotline **+49 951 9324-996**
E-Mail **BIT.TS@wieland-electric.com**

Industrial Automation – Electronics

Hotline **+49 951 9324-995**
E-Mail **AT.TS@wieland-electric.com**

Safety Technology

Hotline **+49 951 9324-999**
E-Mail **safety@wieland-electric.com**



General information and news:
www.wieland-electric.com

Visit our e-catalog at
<http://eshop.wieland-electric.com>



Our subsidiaries

... and the addresses of our sales partner worldwide are available at:

www.wieland-electric.com



USA & CANADA
Wieland Electric Inc.
North American Headquarters
 2889 Brighton Road
 Oakville, Ontario L6H 6C9
 Phone +1 905 8298414
 Fax +1 905 8298413
www.wielandinc.com
www.wieland-electric.ca



GREAT BRITAIN
Wieland Electric Ltd.
 Riverside Business Center,
 Walnut Tree Close
 GB-Guildford/Surrey GU1 4UG
 Phone +44 1483 531213
 Fax +44 1483 505029
sales.uk@wieland-electric.com
www.wieland.co.uk



ITALY
Wieland Electric S.r.l.
 Via Edison, 209
 I-20019 Settimo Milanese
 Phone +39 02 48916357
 Fax +39 02 48920685
info.italy@wieland-electric.com
www.wieland-electric.it



FRANCE
Wieland Electric SARL.
 Le Cérame, Hall 6
 47, avenue des Genottes
 CS 48313
 95803 Cergy-Pontoise Cedex
 Phone +33 1 30320707
 Fax +33 1 30320714
info.france@wieland-electric.com
www.wieland-electric.fr



SPAIN
Wieland Electric S.L.
 C/ Maria Auxiliadora 2, bajos
 E-08017 Barcelona
 Phone +34 93 2523820
 Fax +34 93 2523825
ventas@wieland-electric.com
www.wieland-electric.es



SWITZERLAND
Wieland Electric AG
 Harzachstrasse 2b
 CH-8404 Winterthur
 Phone +41 52 2352100
 Fax +41 52 2352119
info.swiss@wieland-electric.com
www.wieland-electric.ch



BELGIUM & GD LUXEMBOURG
ATEM-Wieland Electric NV
 Bedrijvenpark De Veert 4
 B-2830 Willebroek
 Phone +32 3 8661800
 Fax +32 3 8661828
info.belgium@wieland-electric.com
www.wieland-electric.be



DENMARK
Wieland Electric A/S
 Vallørækken 26
 DK-4600 Køge
 Phone +45 70 266635
 Fax +45 70 266637
sales.denmark@wieland-electric.com
www.wieland-electric.dk



SWEDEN
Wieland Electric AB
 Krossverksgatan 9B
 216 16 Limhamn
 Phone +46 40 652 90 00
sales.sweden@wieland-electric.com
www.wieland-electric.se



POLAND
Wieland Electric Sp. Zo.o.
 Św. Antoniego 8
 62-080 Swadzim
 Phone +48 61 2225400
 Fax +48 61 8407166
office@wieland-electric.pl
www.wieland-electric.pl



CHINA
Wieland Electric Trading
 Unit 2703 International Soho City
 889 Renmin Road,
 Huang Pu District
 PRC- Shanghai 200010
 Phone +86 21 63555833
 Fax +86 21 63550090
info-shanghai@wieland-electric.com
www.wieland-electric.cn



JAPAN
Wieland Electric Co, Ltd.
 Nisso No. 16 Bldg. 7F
 3-8-8 Shin-Yokohama,
 Kohoku-ku
 Yokohama 222-0033
 Phone +81 45 473 5085
 Fax +81 45 470 5408
info.japan@wieland-electric.com



GERMANY
Headquarters
Wieland Electric GmbH
 Brennerstraße 10 – 14
 96052 Bamberg, Germany
 Phone +49 951 9324-0
 Fax +49 951 9324-198
info@wieland-electric.com
www.wieland-electric.de

Subject to technical modifications! **gesis**®, **RST**®, **GST**®, **GST18**®, **podis**®, **samos**® and **saris**® are registered trademarks of Wieland Electric GmbH



Headquarters:
Wieland Electric GmbH
Brennerstraße 10 – 14
96052 Bamberg, Germany

Phone +49 951 9324-0
Fax +49 951 9324-198
info@wieland-electric.com
www.wieland-electric.com

Industrial technology

Solutions for the control cabinet

- DIN rail terminal blocks
 - Screw, tension spring or push-in connection technology
 - Wire cross sections up to 300 mm²
 - Numerous special functions
 - Software solutions interfacing to CAE systems
- Safety
 - Safe signal acquisition
 - Safety switching devices
 - Modular safety modules
 - Compact safety controllers
 - Application consulting and training
- Network engineering and fieldbus systems
 - Remote maintenance via VPN industrial router and VPN service portal
 - Industrial Ethernet switches
 - PLC and I/O systems, standard and increased environmental conditions
- Interface
 - Power supply units
 - Overvoltage protection
 - Coupling relays, semiconductor switches
 - Timer relays, measuring and monitoring relays
 - Analog coupling and converter modules
 - Passive interfaces

Solutions for field applications

- Decentralized installation and automation technology
 - Electrical installation for wind tower
 - Fieldbus interfaces and motor starters
- Connectors for industrial applications
 - Rectangular and round connectors
 - Aluminium or plastic housings
 - Degree of protection up to IP 69
 - Current-carrying capacity up to 100 A
 - Connectors for hazardous areas
 - Modular, application-specific technology

PC board terminals and connectors

- Screw or spring clamp connection technology
- Spacings: 3.5 mm to 10.16 mm
- Reflow or wave soldering process

Building and installation technology

- Building installation systems
 - Main power supply connectors IP 20/IP 65... IP 69
 - Bus connectors
 - Low-voltage connectors
 - Power distribution system with flat cables
 - Distribution systems
 - Room automation with KNX, EnOcean, SMI and DALI
 - DIN rail terminal blocks for electrical installations
 - Overvoltage protection