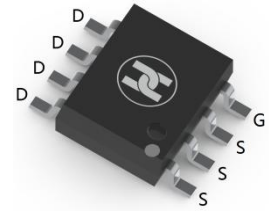
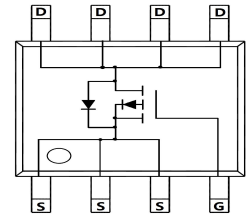

**LOW VOLTAGE MOSFET (P-CHANNEL)**
**FEATURES**

- Ultra low on-resistance:  $V_{DS}=-30V, I_D=-1A, R_{DS(ON)} \leq 21m\Omega @ V_{GS}=-10V$
- Ultra low gate charge
- For load switch or in PWM applications
- Surface Mount device

**SOP-8**

**MECHANICAL DATA**

- Case: SOP-8
- Case Material: Molded Plastic. UL flammability
- Classification Rating: 94V-0
- Weight: 0.3 grams (approximate)
- Marking: 4435

**MAXIMUM RATINGS ( $T_A = 25^\circ C$  unless otherwise noted)**

Parameter	Symbol	10Sec	Steady state	Unit
Drain-source voltage	$V_{DS}$		-30	V
Gate-source voltage	$V_{GS}$		$\pm 20$	V
Continuous drain current	$I_D$	$T_A = 25^\circ C$	-10	A
		$T_A = 70^\circ C$	-8	A
Pulsed drain current	$I_{DM}$		-29	A
Power dissipation	$P_D$	$T_A = 25^\circ C$	1.92	W
		$T_A = 70^\circ C$	1.15	W
Thermal resistance from Junction to ambient	$R_{\theta JA}$		65	$^\circ C/W$
Thermal resistance from Junction to Lead	$R_{\theta JL}$		24	$^\circ C/W$
Junction temperature	$T_J$		150	$^\circ C$
Storage temperature	$T_{STG}$		-55 ~ +150	$^\circ C$

**ELECTRICAL CHARACTERISTICS ( $T_A = 25^\circ C$  unless otherwise specified)**

Parameter	Symbol	Min	Typ	Max	Unit	Conditions
Drain-Source breakdown voltage	$V_{(BR)DSS}^*$	-30			V	$V_{GS}=0V, I_D=-250\mu A$
Zero gate voltage drain current	$I_{DSS}^*$			-1	$\mu A$	$V_{DS}=-30V, V_{GS}=0V$
Gate-body leakage current	$I_{GSS}^*$			$\pm 100$	nA	$V_{DS}=0V, V_{GS}=\pm 20V$
Gate-threshold voltage	$V_{GS(th)}^*$	-1.0	-1.6	-2.5	V	$V_{DS}=V_{GS}, I_D=-250\mu A$
On-State Drain Current	$I_{D(ON)}^*$	-80			A	$V_{DS}=-5V, V_{GS}=-10V$
Drain-source on-resistance	$R_{DS(ON)}^*$		16	21	m $\Omega$	$V_{GS}=-10V, I_D=-1A$
			20	38	m $\Omega$	$V_{GS}=-4.5V, I_D=-1A$
Forward transconductance	$g_{FS}$		22		S	$V_{DS}=-5V, I_D=-1A$
Diode forward voltage	$V_{SD}$			-1.5	V	$I_S=-1A, V_{GS}=0V$
Diode forward current	$I_S$			-3.5	A	
Input capacitance	$C_{iss}$		1130	1400	pF	$V_{DS}=-15V, V_{GS}=0V, f=1MHz$
Output capacitance	$C_{oss}$		240		pF	
Reverse transfer capacitance	$C_{rss}$		155		pF	
Gate resistance	$R_g$		5.8	8	$\Omega$	$V_{DS}=0V, V_{GS}=0V, f=1MHz$
Total gate charge	$Q_g$		9.5		nC	$V_{GS}=-4.5V, V_{DS}=-15V, I_D=-1A$
Total gate charge			18	24	nC	$V_{GS}=-10V, V_{DS}=-15V, I_D=-1A$
Gate-source charge	$Q_{gs}$		5.5		nC	
Gate-drain charge	$Q_{gd}$		3.3		nC	
Turn-on delay time	$t_{d(on)}$		8.7		nS	$V_{GS}=-10V, V_{DS}=-15V, R_{GEN}=3\Omega, R_L=1.67\Omega$
Turn-on rise time	$t_r$		8.5		nS	
Turn-off delay time	$t_{d(off)}$		18		nS	
Turn-off fall time	$t_f$		7		nS	
Body Diode Reverse Recovery Time	$t_{rr}$		25	30	nS	$I_F=-10A, di/dt=100A/\mu s$
Body Diode Reverse Recovery Charge	$Q_{rr}$		12		nC	$I_F=-10A, di/dt=100A/\mu s$

\*Pulse test ; Pulse width  $\leq 300\mu s$ , Duty cycle  $\leq 0.5\%$  .

**LOW VOLTAGE MOSFET (P-CHANNEL)**

**TYPICAL ELECTRICAL AND THERMAL CHARACTERISTICS**

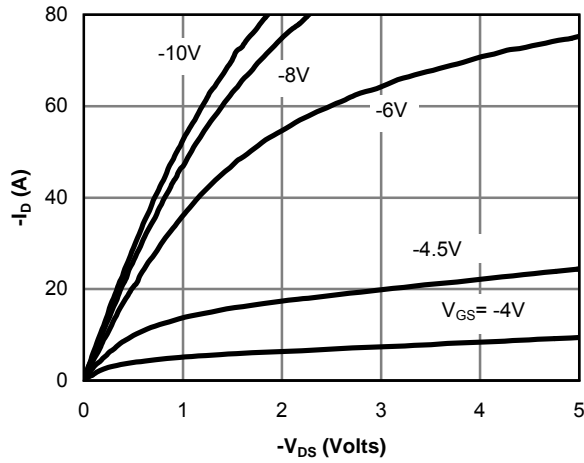

**Figure 1: On-Region Characteristics**

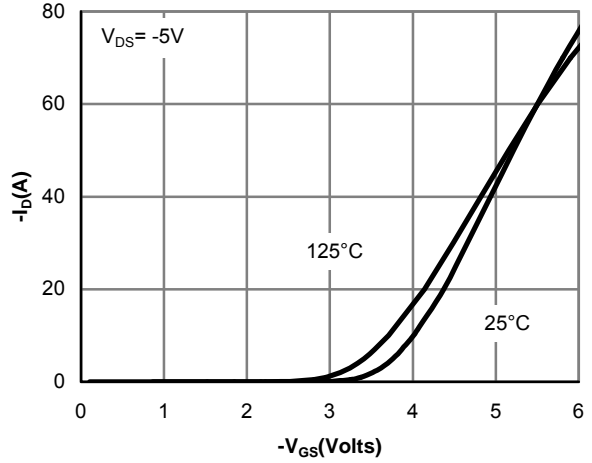

**Figure 2: Transfer Characteristics**

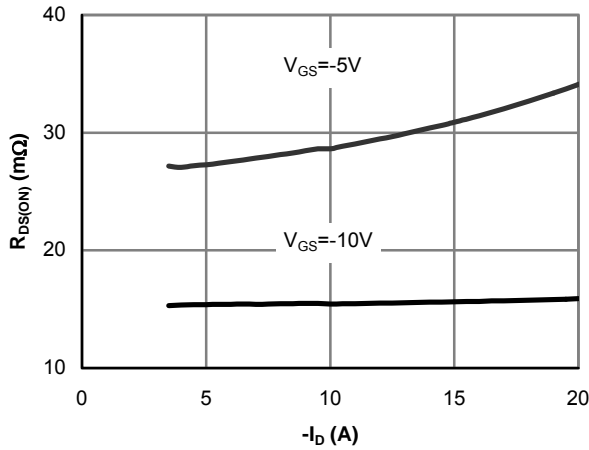

**Figure 3: On-Resistance vs. Drain Current and Gate Voltage**

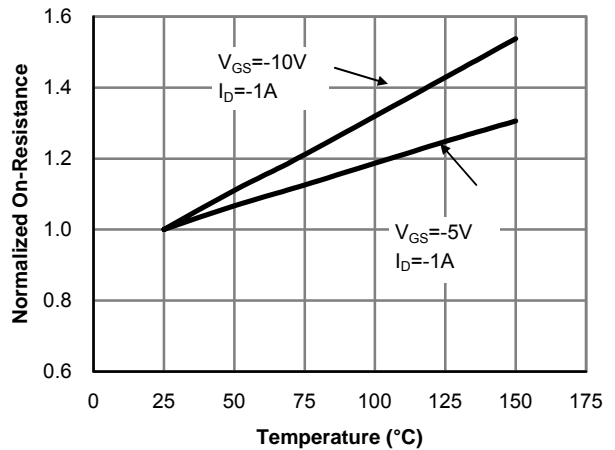

**Figure 4: On-Resistance vs. Junction Temperature**

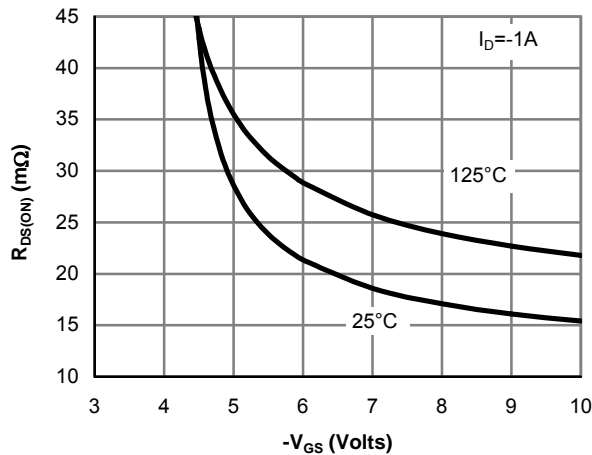

**Figure 5: On-Resistance vs. Gate-Source Voltage**

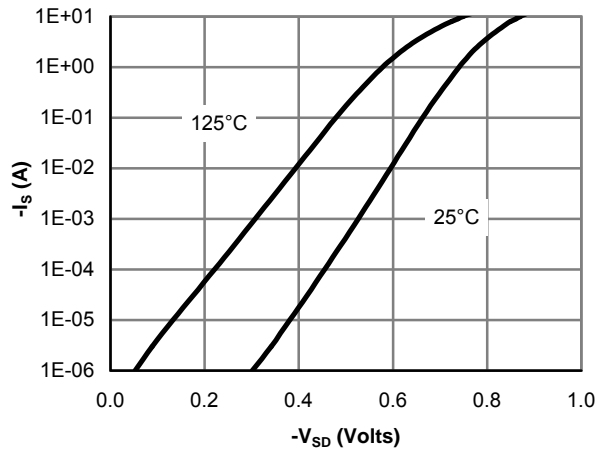

**Figure 6: Body-Diode Characteristics**

**LOW VOLTAGE MOSFET (P-CHANNEL)**

**TYPICAL ELECTRICAL AND THERMAL CHARACTERISTICS**

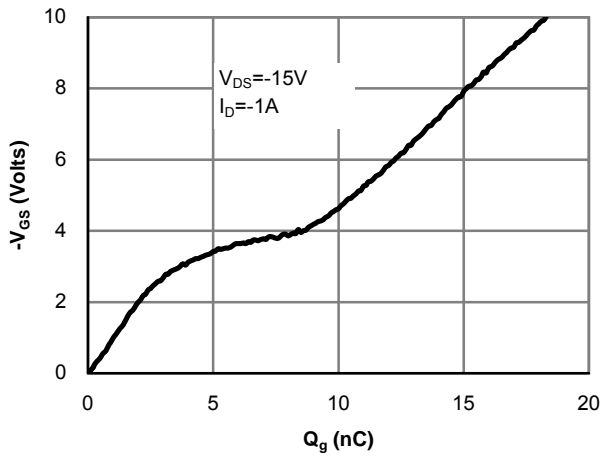

**Figure 7: Gate-Charge Characteristics**

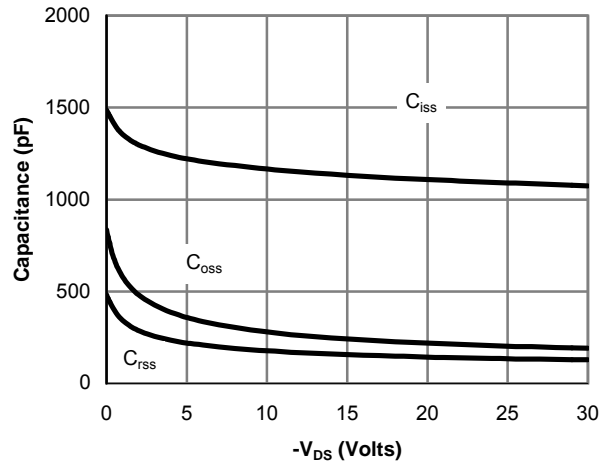

**Figure 8: Capacitance Characteristics**

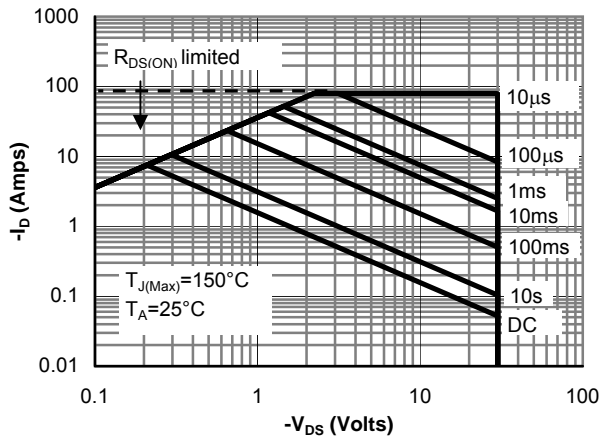

**Figure 9: Maximum Forward Biased Safe Operating Area**

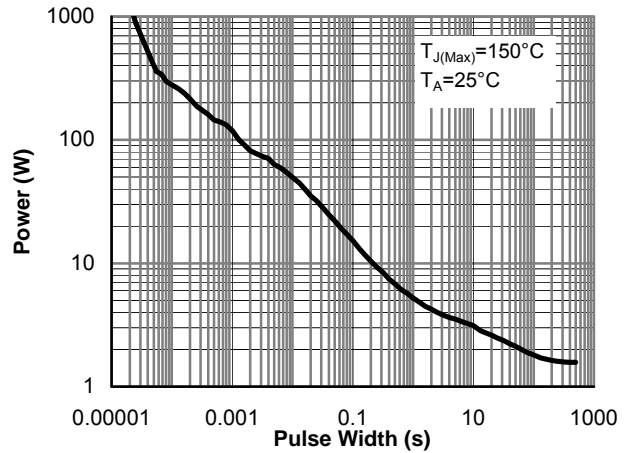

**Figure 10: Single Pulse Power Rating Junction-to-Ambient**

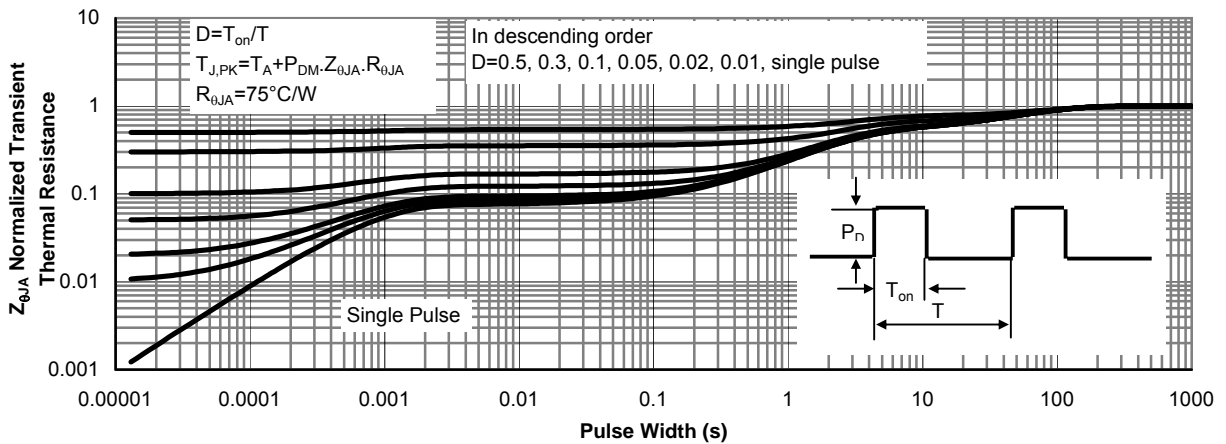

**Figure 11: Normalized Maximum Transient Thermal Impedance**

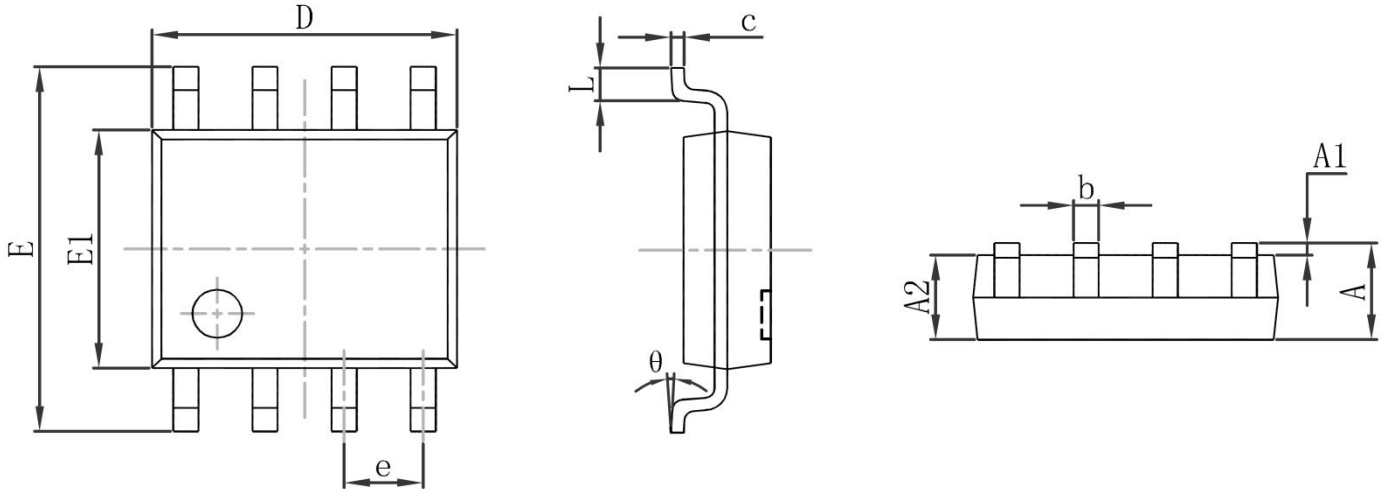
**LOW VOLTAGE MOSFET (P-CHANNEL)**
**SOP-8 Package Outline Dimensions**

Symbol	Dimensions In Millimeters		Dimensions In Inches	
	Min.	Max.	Min.	Max.
A	1.350	1.750	0.053	0.069
A1	0.100	0.250	0.004	0.010
A2	1.350	1.550	0.053	0.061
b	0.330	0.510	0.013	0.020
c	0.170	0.250	0.007	0.010
D	4.800	5.000	0.189	0.197
e	1.270(BSC)		0.050 (BSC)	
E	5.800	6.200	0.228	0.244
E1	3.800	4.000	0.150	0.157
L	0.400	1.270	0.016	0.050
$\theta$	0°	8°	0°	8°

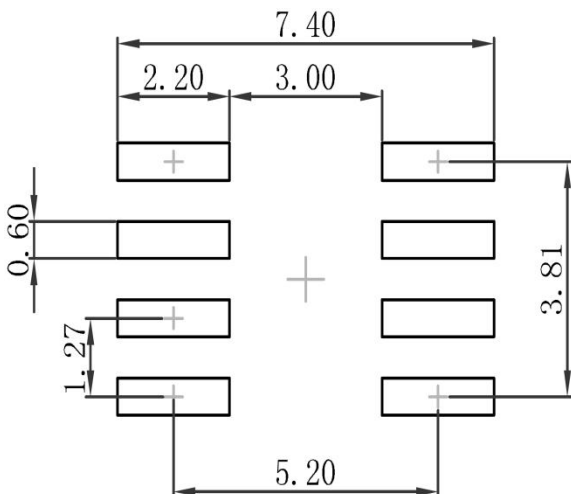
**SOP-8 Suggested Pad Layout**

**Note:**

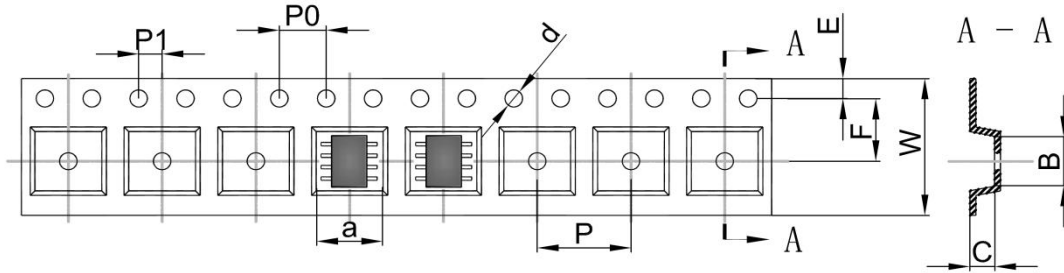
1. Controlling dimension: in millimeters
2. General tolerance:  $\pm 0.05\text{mm}$
3. The pad layout is for reference purposes only

**LOW VOLTAGE MOSFET (P-CHANNEL)**
**SOP-8 Tape and Reel**
**SOP-8 Embossed Carrier Tape**

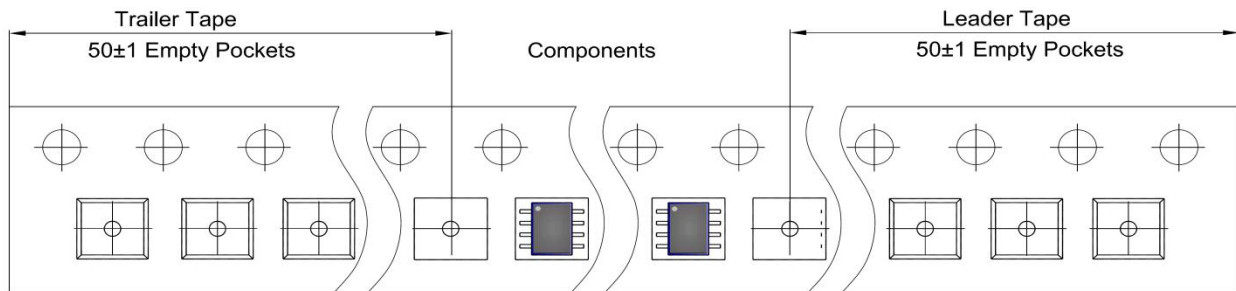
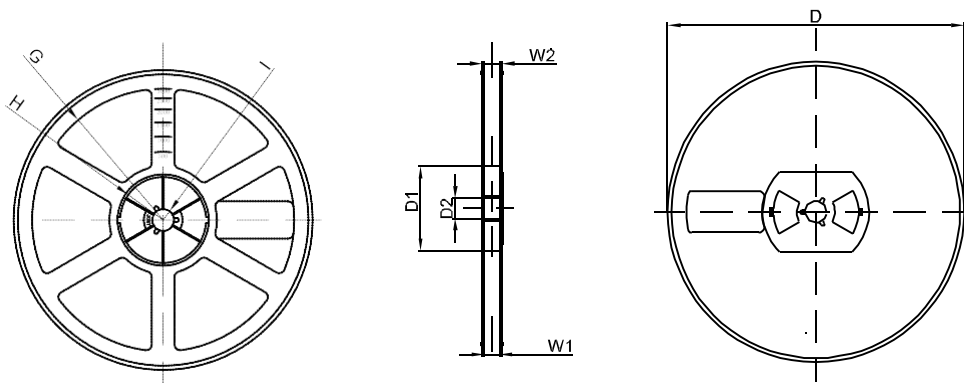
DIMENSIONS ARE IN MILLIMETER										
TYPE	A	B	C	d	E	F	P0	P	P1	W
SOP-8	6.40	5.40	2.10	Ø1.50	1.75	5.50	4.00	8.00	2.00	12.00
TOLERANCE	±0.1	±0.1	±0.1	±0.1	±0.1	±0.1	±0.1	±0.1	±0.1	±0.1

**SOP-8 Tape Leader and Trailer**

**SOP-8 Reel**

DIMENSIONS ARE IN MILLIMETER								
REEL OPTION	D	D1	D2	G	H	I	W1	W2
13" DIA	Ø330.00	100.00	13.00	R151.00	R56.00	R6.50	12.40	17.60
TOLERANCE	±2	±1	±1	±1	±1	±1	±1	±1