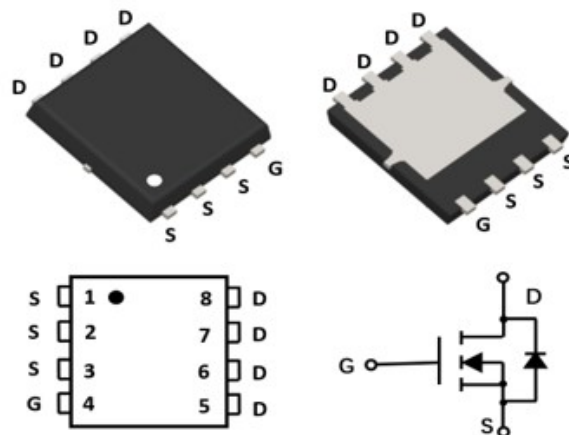

MOSFET (N-CHANNEL)
FEATURES

- Low on-resistance
- Fast switching speed
- Easily designed drive circuits
- Easy to parallel

MECHANICAL DATA

- Case: PDFN5x6
- Case Material: Molded Plastic. UL flammability
- Classification Rating: 94V-0
- Weight: 0.016 grams (approximate)
- **Marking:G48N10**

PDFN 5X6

MAXIMUM RATINGS (T_A = 25°C unless otherwise noted)

Parameter	Symbol	Value	Unit
Drain-source voltage	V _{DS}	100	V
Gate-source voltage	V _{GS}	±20V	V
Continuous drain current	I _D	79	A
Power dissipation	P _D	100	W
Thermal resistance from Junction to ambient	R _{θJA}	45	°C/W
Junction and Storage temperature	T _J , T _{STG}	-55 ~+150	°C

ELECTRICAL CHARACTERISTICS (T_A = 25°C unless otherwise specified)

Parameter	Symbol	Min	Typ	Max	Unit	Conditions
Off Characteristics						
Drain-Source breakdown voltage	V _{(BR)DSS}	100			V	V _{GS} =0V, I _D =250μA
Zero gate voltage drain current	I _{DSS}			1	μA	V _{DS} =80V, V _{GS} =0V
Gate-body leakage current	I _{GSS}			±100	nA	V _{DS} =0V, V _{GS} =±20V
Gate-threshold voltage (note 1)	V _{GS(th)}	1.2	1.8	2.5		V _{DS} =20V, I _D =250μA
Drain-source on-resistance (note 1)	R _{DS(ON)}		6.8	8	mΩ	V _{GS} =10V, I _D =30A
			10.5	12.5	mΩ	V _{GS} =4.5V, I _D =15A
Dynamic Characteristics						
Input capacitance	C _{iss}		3650		pF	V _{DS} =50V, V _{GS} =0V, f=1MHz
Output capacitance	C _{oss}		320		pF	
Reverse transfer capacitance	C _{rss}		22		pF	
Switching Characteristics						
Turn-on delay time	t _{d(on)}		16		nS	V _{DD} =50V, I _D =40A R _g =2Ω
Turn-on rise time	t _r		11		nS	
Turn-off delay time	t _{d(off)}		35		nS	
Turn-off fall time	t _f		9		nS	

Note:1. Pulse test ; Pulse width ≤300μs, Duty cycle ≤ 2% .

MOSFET (N-CHANNEL)

Typical Characteristics

Figure 1. Output Characteristics

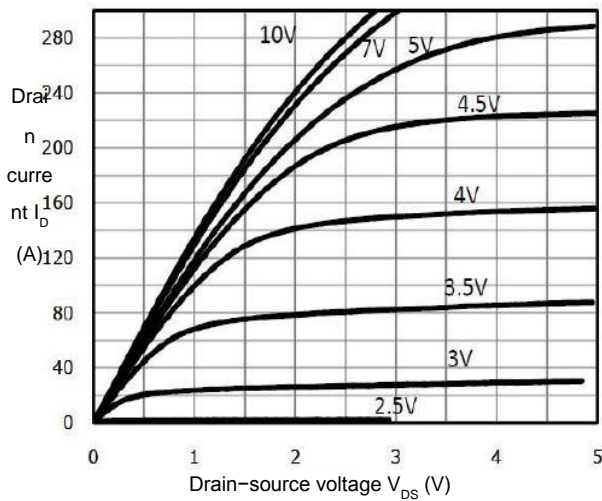

Figure 2. Transfer Characteristics

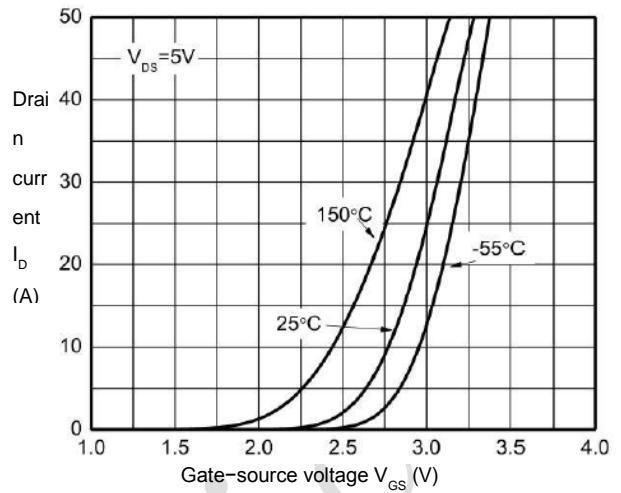

Figure 3. On-Resistance vs. Drain Current

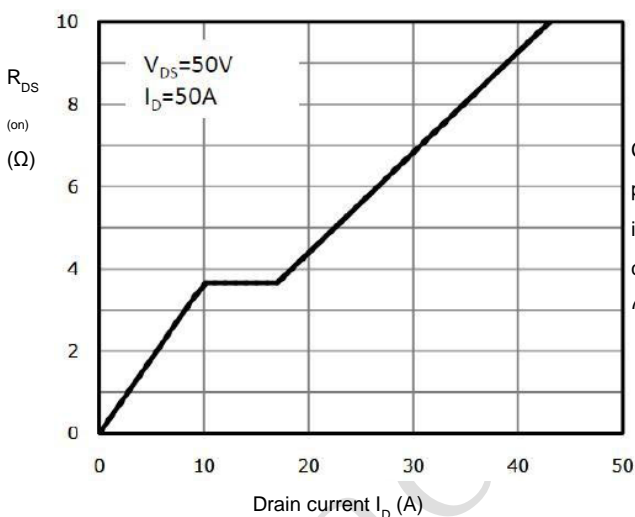

Figure 4. Capacitance Characteristics

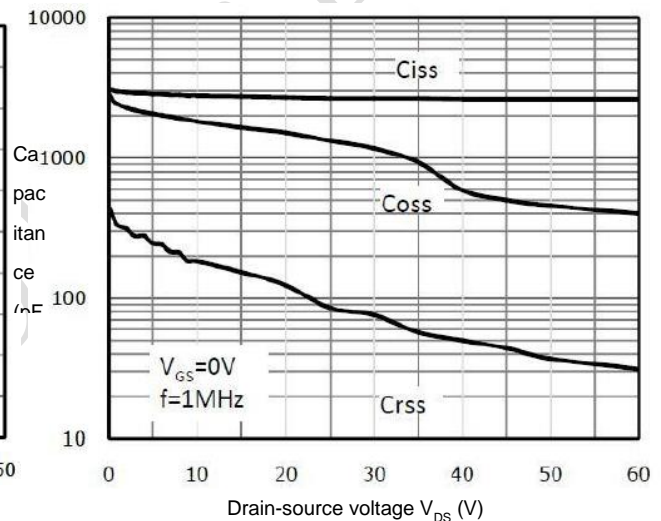

Figure 5. Gate Charge Characteristics

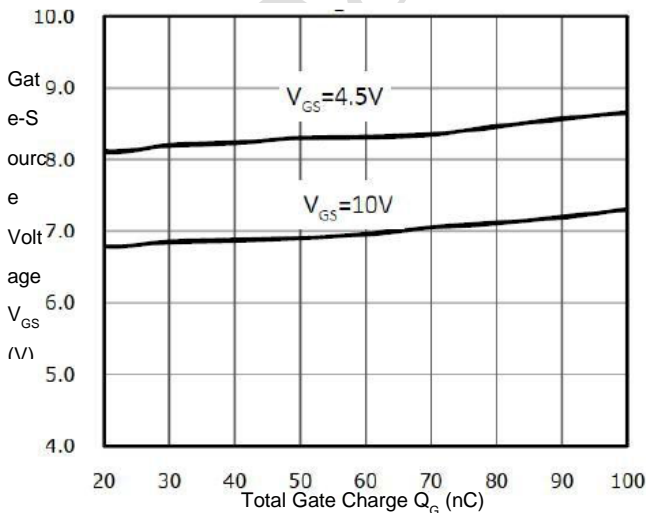
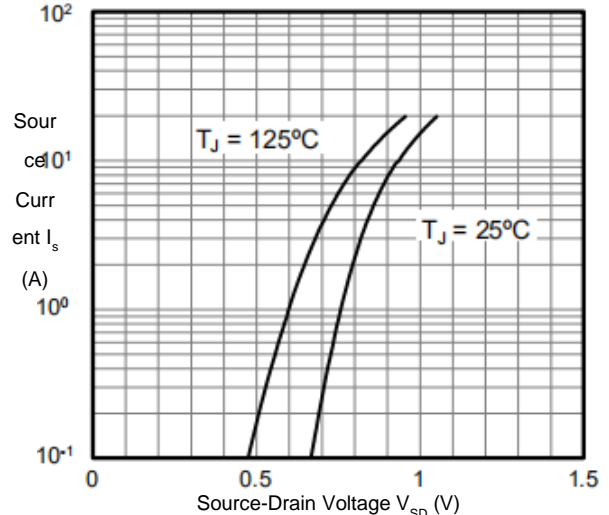

Figure 6. Body Diode Forward Voltage



MOSFET (N-CHANNEL)

Typical Characteristics

Figure 7. Breakdown Voltage vs. Temperature

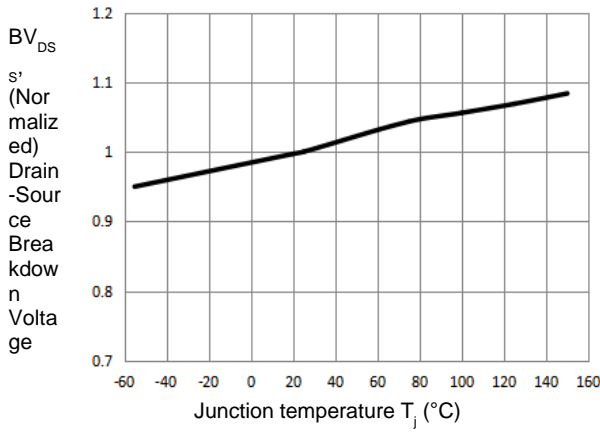

Figure 8. On-Resistance vs. Temperature

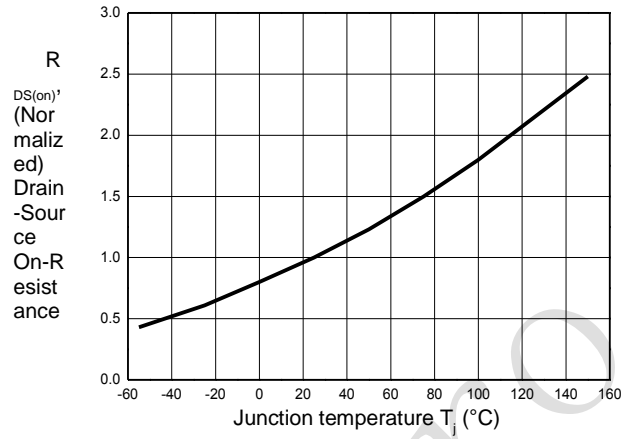

Figure 9. Transient Thermal Impedance

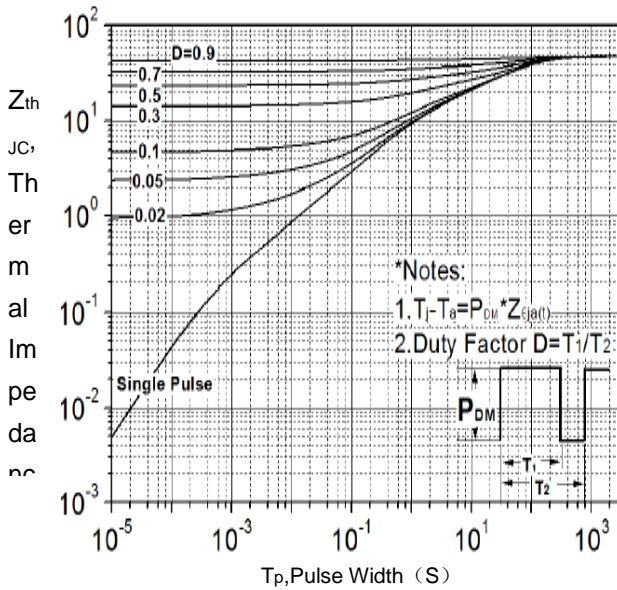
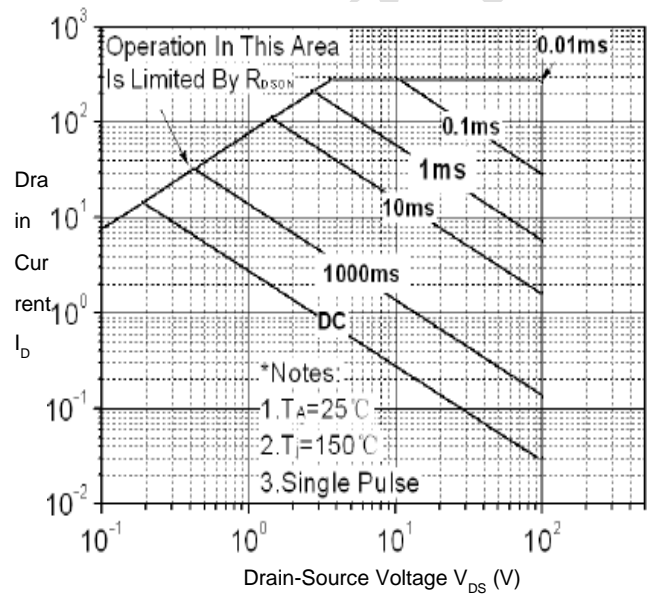
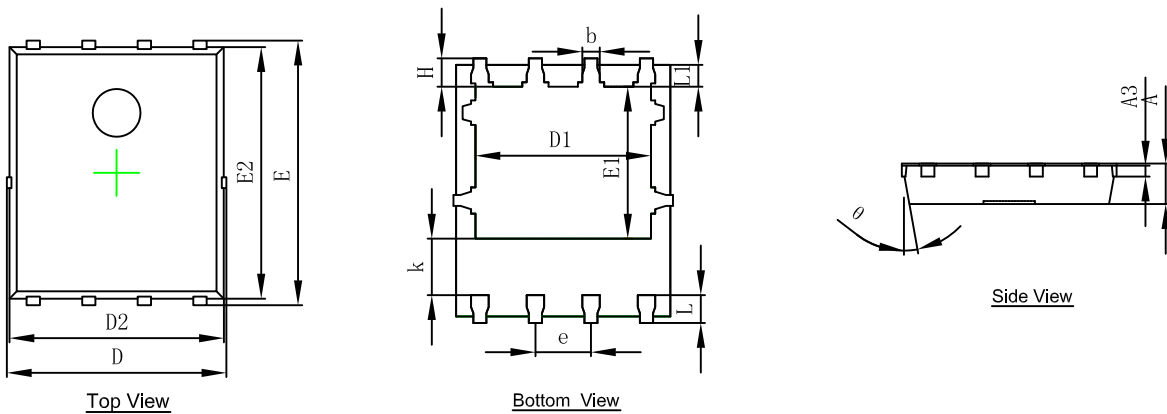

Figure 10. Maximum Safe Operating Area



MOSFET (N-CHANNEL)

PDFN5X6 Package information



Symbol	Dimensions In Millimeters		Dimensions In Inches	
	Min.	Max.	Min.	Max.
A	0.900	1.000	0.035	0.039
A3	0.254REF.		0.010REF.	
D	4.944	5.096	0.195	0.201
E	5.974	6.126	0.235	0.241
D1	3.910	4.110	0.154	0.162
E1	3.375	3.575	0.133	0.141
D2	4.824	4.976	0.190	0.196
E2	5.674	5.826	0.223	0.229
k	1.190	1.390	0.047	0.055
b	0.350	0.450	0.014	0.018
e	1.270TYP.		0.050TYP.	
L	0.559	0.711	0.022	0.028
L1	0.424	0.576	0.017	0.023
H	0.574	0.726	0.023	0.029
θ	10°	12°	10°	12°

PDFN 5x6 Suggested Pad Layout

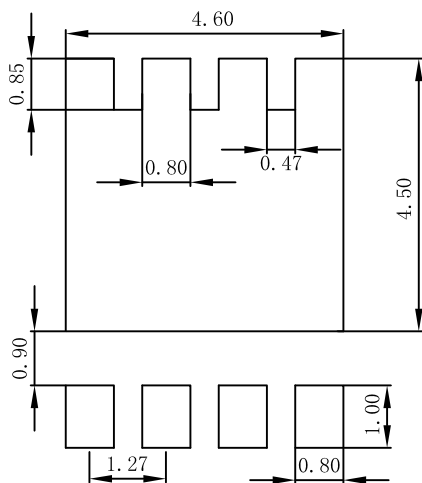

Note:
 1. Controlling dimension: in millimeters.
 2. General tolerance: ± 0.05 mm.
 3. The pad layout is for reference purposes only.

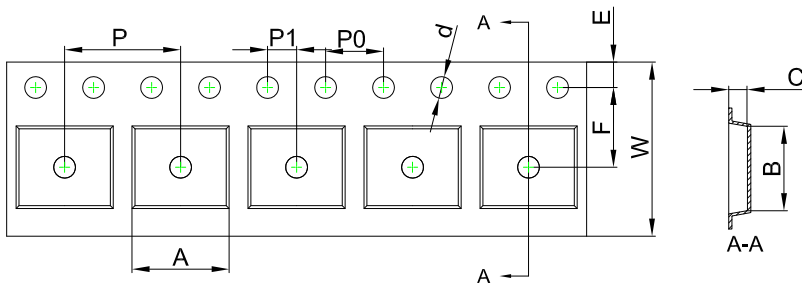
MOSFET (N-CHANNEL)
PDFN 5x6 Embossed Carrier Tape

Dimensions are in millimeter										
Pkg type	A	B	C	d	E	F	P0	P	P1	W
PDFN 5x6	6.30	5.30	1.10	Ø1.50	1.75	5.50	4.00	8.00	2.00	12.00

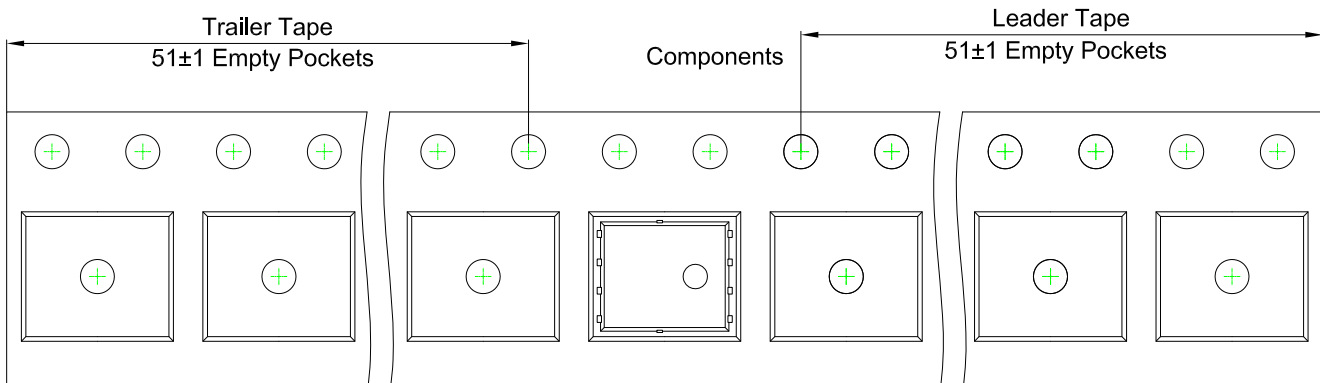
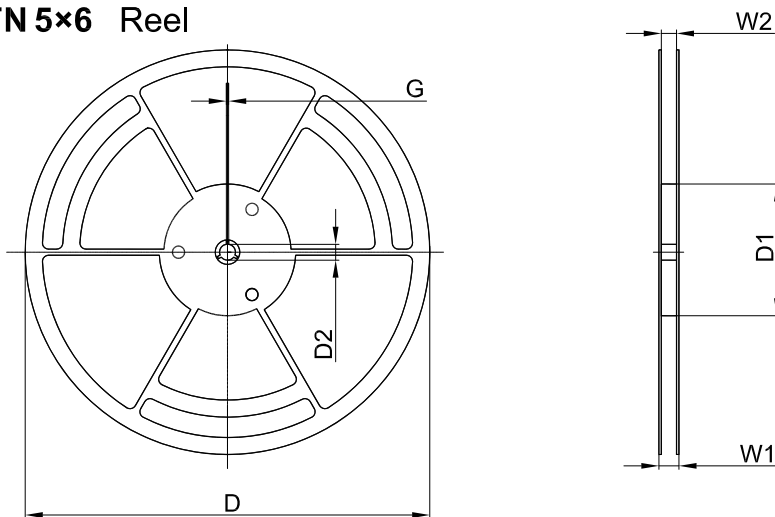
PDFN 5x6 Tape Leader and Trailer

PDFN 5x6 Reel

Dimensions are in millimeter						
Reel Option	D	D1	D2	G	W1	W2
13" Dia	Ø330.00	100.00	13.00	1.90	17.60	12.40

REEL	Reel Size	Box	Box Size(mm)	Carton	Carton Size(mm)
5,000 pcs	13 inch	5,000 pcs	340×336×29	50,000 pcs	353×346×365