

**Thyristors**

**SKT 55**  
**SKT 80**  
**SKT 100**



V <sub>RSM</sub>	V <sub>RRM</sub> V <sub>DRM</sub>	(dv/dt) <sub>cr</sub>	I <sub>T</sub> RMS (maximum values for continuous operation)		
			110 A	135 A	175 A
V	V	V/μs	I <sub>TAV</sub> (sin. 180; T <sub>case</sub> = 80 °C)		
			70 A	86 A	110 A
500	400	500	<b>SKT 55/04 D</b>	–	<b>SKT 100/04 D</b>
700	600	500	<b>SKT 55/06 D</b>	<b>SKT 80/06 D*</b>	<b>SKT 100/06 D*</b>
900	800	500	<b>SKT 55/08 D</b>	<b>SKT 80/08 D</b>	<b>SKT 100/08 D</b>
1300	1200	1000	<b>SKT 55/12 E</b>	<b>SKT 80/12 E*</b>	<b>SKT 100/12 E*</b>
1500	1400	1000	<b>SKT 55/14 E</b>	<b>SKT 80/14 E</b>	<b>SKT 100/14 E*</b>
1700	1600	1000	<b>SKT 55/16 E</b>	<b>SKT 80/16 E*</b>	<b>SKT 100/16 E*</b>
1900	1800	1000	<b>SKT 55/18 E↓</b>	<b>SKT 80/18 E↓</b>	<b>SKT 100/18 E↓</b>

Symbol	Conditions	SKT 55	SKT 80	SKT 100	Units
I <sub>TAV</sub>	sin. 180; (T <sub>case</sub> = ... °C)	55 (92)	80 (85)	100 (85)	A °C
I <sub>TSM</sub>	T <sub>vj</sub> = 25 °C; 10 ms T <sub>vj</sub> = 130 °C; 10 ms	1300 1100	1700 1500	2000 1750	A A
i <sup>2</sup> t	T <sub>vj</sub> = 25 °C; 8,35 ... 10 ms T <sub>vj</sub> = 130 °C; 8,35 ... 10 ms	8 500 6 000	14 500 11 000	20 000 15 000	A <sup>2</sup> s A <sup>2</sup> s
t <sub>gd</sub>	T <sub>vj</sub> = 25 °C; I <sub>G</sub> = 1 A; di <sub>G</sub> /dt = 1 A/μs	typ. 1			μs
t <sub>gr</sub>	V <sub>D</sub> = 0,67 · V <sub>DRM</sub>	typ. 2			μs
(di/dt) <sub>cr</sub>	f = 50 ... 60 Hz	50			A/μs
I <sub>H</sub>	T <sub>vj</sub> = 25 °C	typ. 150; max. 250			mA
I <sub>L</sub>	T <sub>vj</sub> = 25 °C	typ. 300; max. 600			mA
t <sub>q</sub>	T <sub>vj</sub> = 130 °C; typ.	100			μs
V <sub>T</sub>	T <sub>vj</sub> = 25 °C; (I <sub>T</sub> = ...); max.	1,8 (200)	2,25 (300)	1,75 (300)	V A
V <sub>T(TO)</sub>	T <sub>vj</sub> = 130 °C	0,9	1,2	1,0	V
r <sub>T</sub>	T <sub>vj</sub> = 130 °C	4	4	2,4	mΩ
I <sub>DD</sub> , I <sub>RD</sub>	T <sub>vj</sub> = 130 °C; V <sub>DD</sub> = V <sub>DRM</sub> V <sub>RD</sub> = V <sub>RRM</sub>	25	30	30	mA
V <sub>GT</sub>	T <sub>vj</sub> = 25 °C	3			V
I <sub>GT</sub>	T <sub>vj</sub> = 25 °C	150			mA
V <sub>GD</sub>	T <sub>vj</sub> = 130 °C	0,25			V
I <sub>GD</sub>	T <sub>vj</sub> = 130 °C	10			mA
R <sub>thjc</sub>	cont.	0,40	0,25		°C/W
	sin. 180/rec. 120	0,47/0,53	0,28/0,31		°C/W
R <sub>thch</sub>		0,08			°C/W
T <sub>vj</sub>		– 40 ... +130			°C
T <sub>stg</sub>		– 55 ... +150			°C
M	SI units (US units)	10 (90 lb.in.)			Nm
a		5 · 9,81			m/s <sup>2</sup>
w		65	80		g
Case		B 5			

**Features**

- Hermetic metal cases with ceramic insulators
- Threaded studs ISO M12 or UNF 1/2-20
- Interchangeable with international standard cases

**Typical Applications**

- DC motor control (e. g. for machine tools)
- Controlled rectifiers (e. g. for battery charging)
- AC controllers (e. g. for temperature control)

\* Available with UNF thread 1/2-20 UNF2A; e.g. SKT 80/06 D UNF

♦ available in limited quantities

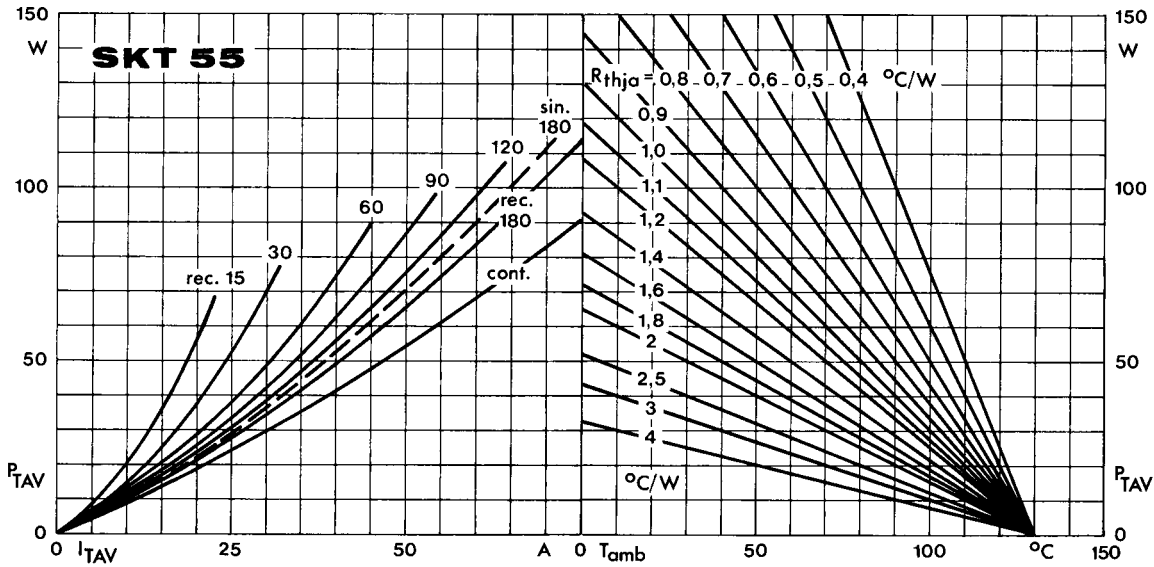

Fig. 1 a Power dissipation vs. on-state current and ambient temperature

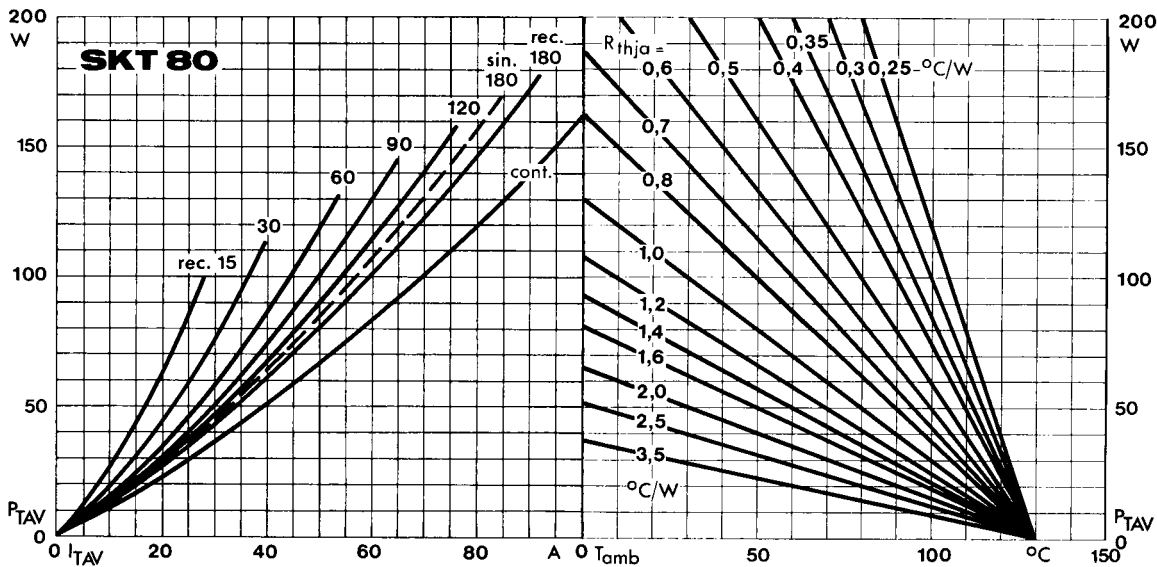

Fig. 1 b Power dissipation vs. on-state current and ambient temperature

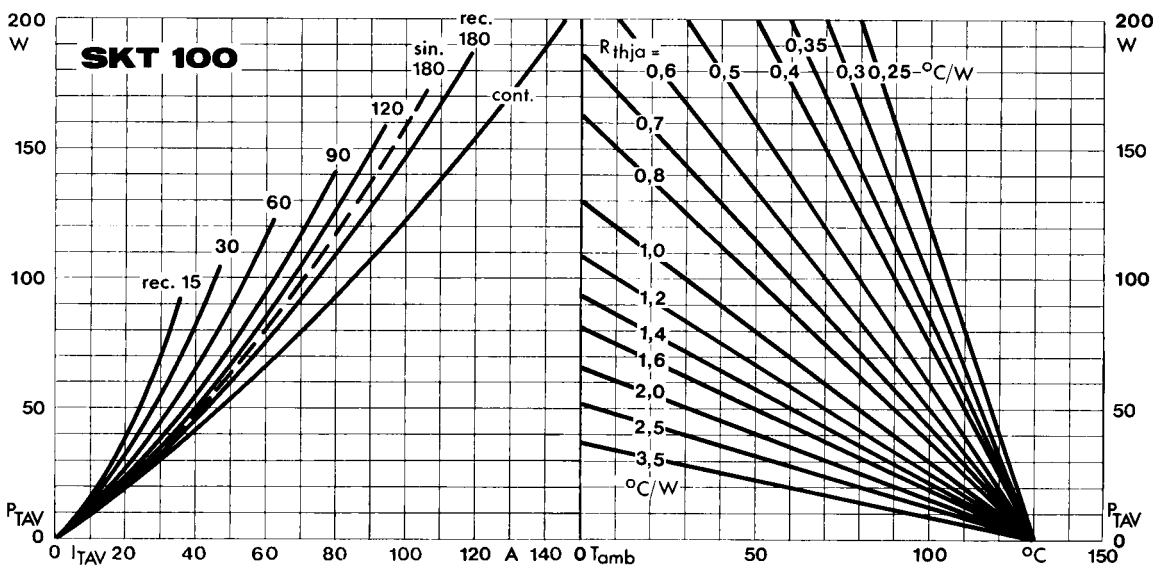

Fig. 1 c Power dissipation vs. on-state current and ambient temperature

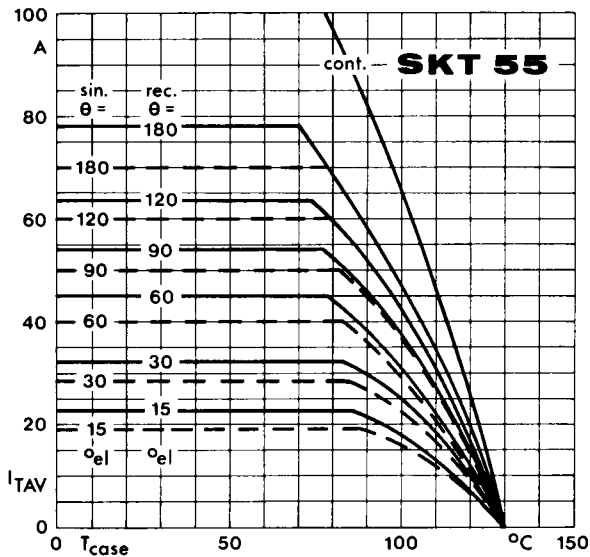

Fig. 2 a Rated on-state current vs. case temperature

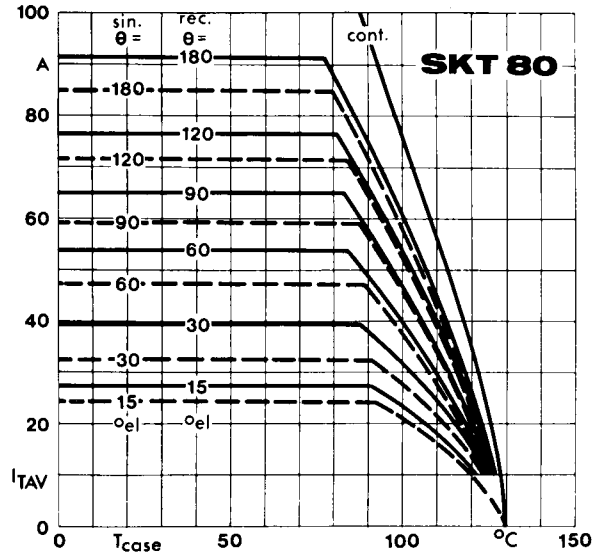

Fig. 2 b Rated on-state current vs. case temperature

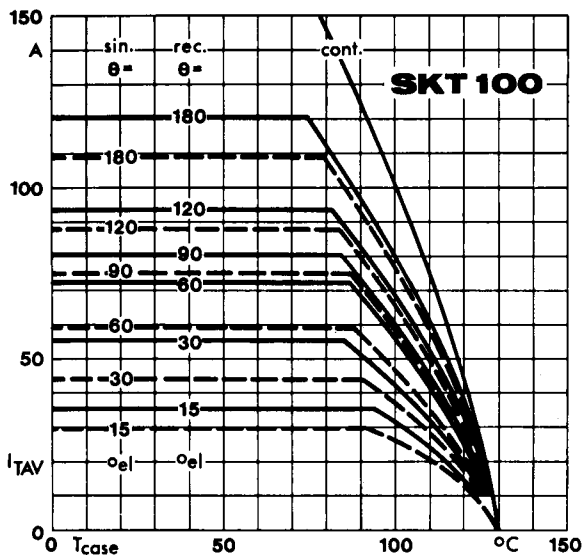

Fig. 2 c Rated on-state current vs. case temperature

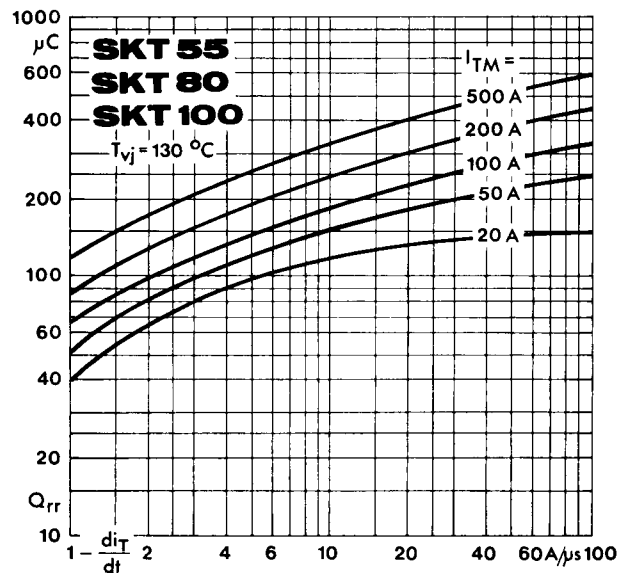

Fig. 3 Recovered charge vs. current decrease

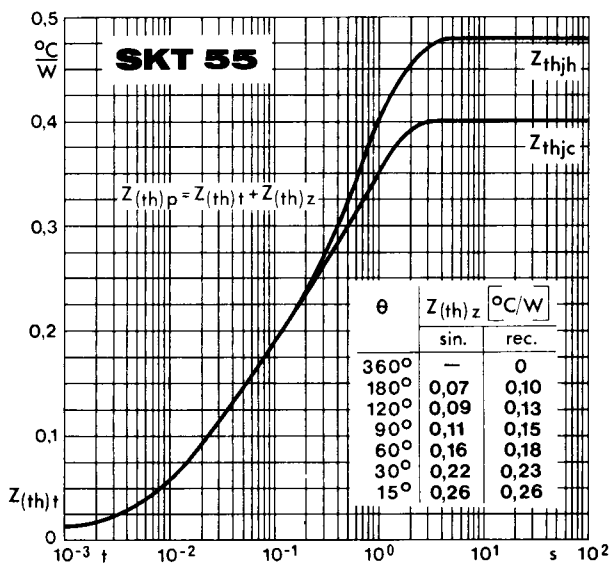

Fig. 4 a Transient thermal impedance vs. time

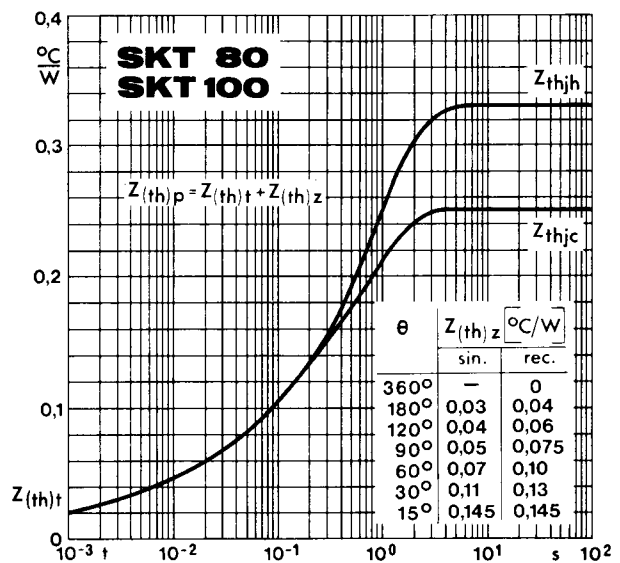

Fig. 4 b Transient thermal impedance vs. time

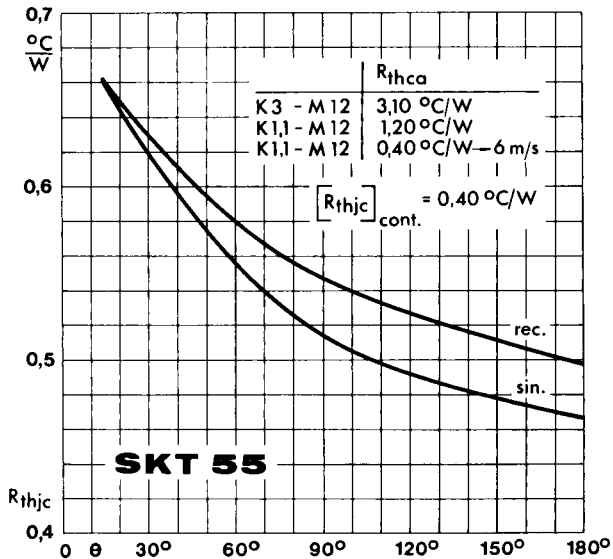

Fig. 5 a Thermal resistance vs. conduction angle

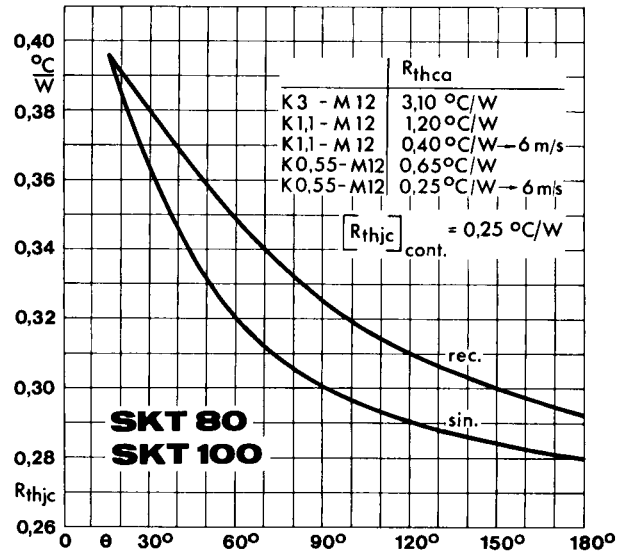

Fig. 5 b Thermal resistance vs. conduction angle

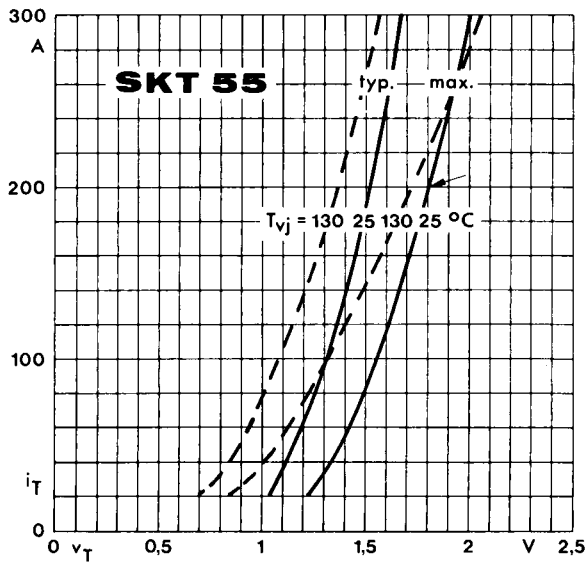

Fig. 6 a On-state characteristics

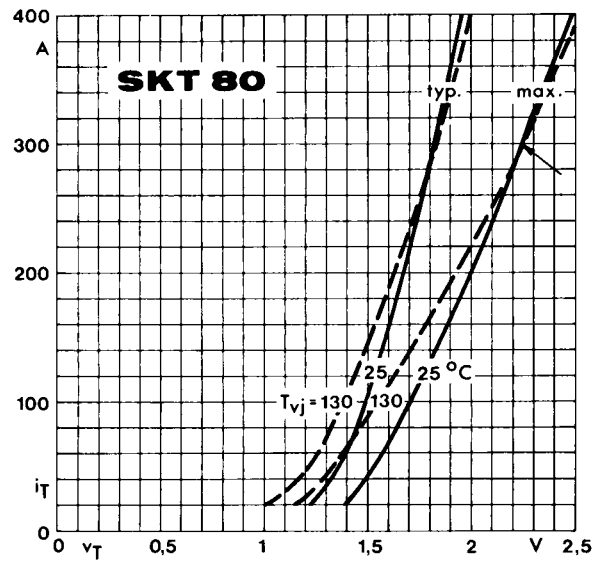

Fig. 6 b On-state characteristics

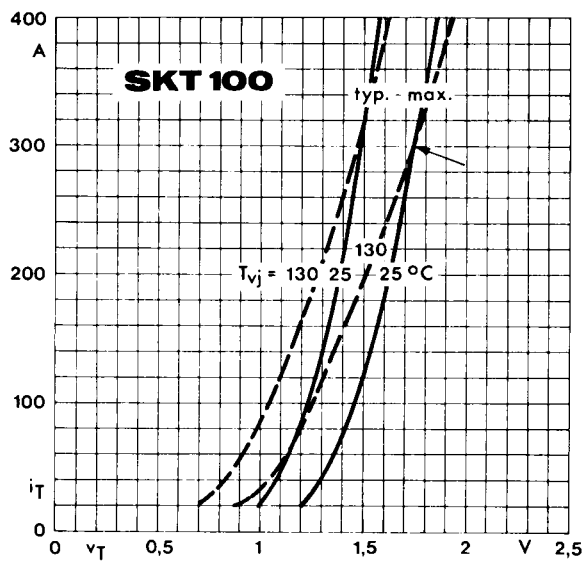

Fig. 6 c On-state characteristics

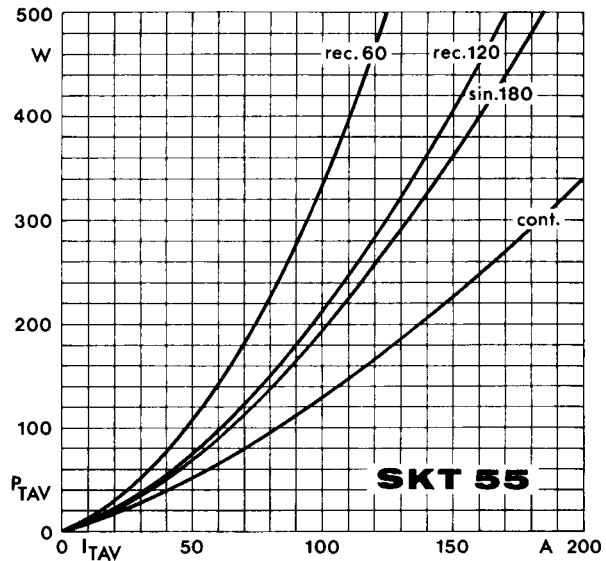

Fig. 7 a Power dissipation vs. on-state current

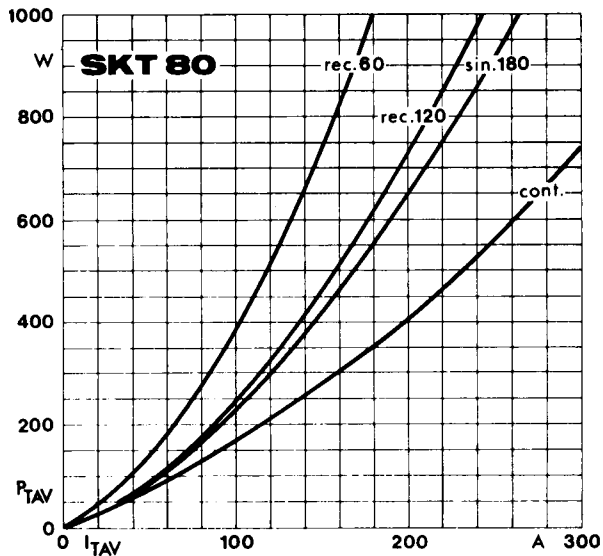

Fig. 7 b Power dissipation vs. on-state current

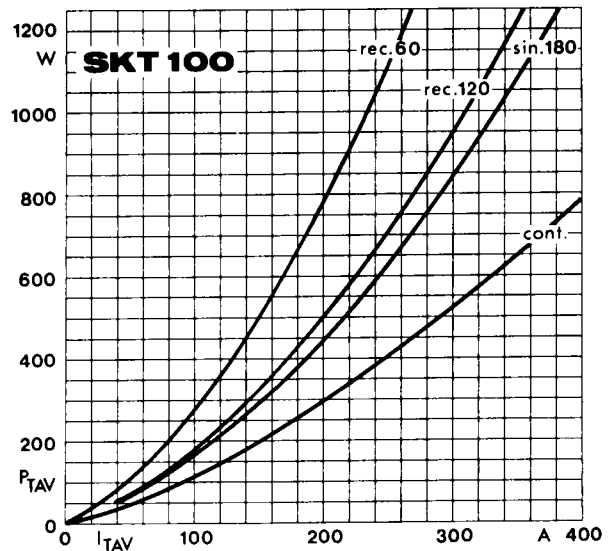

Fig. 7 c Power dissipation vs. on-state current

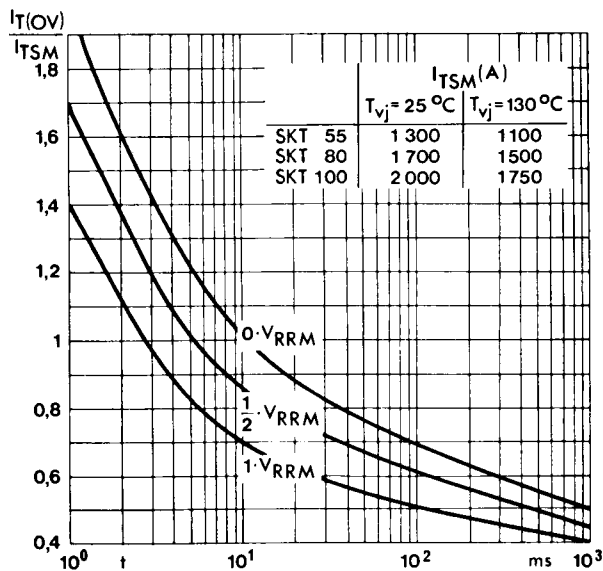

Fig. 8 Surge overload current vs. time

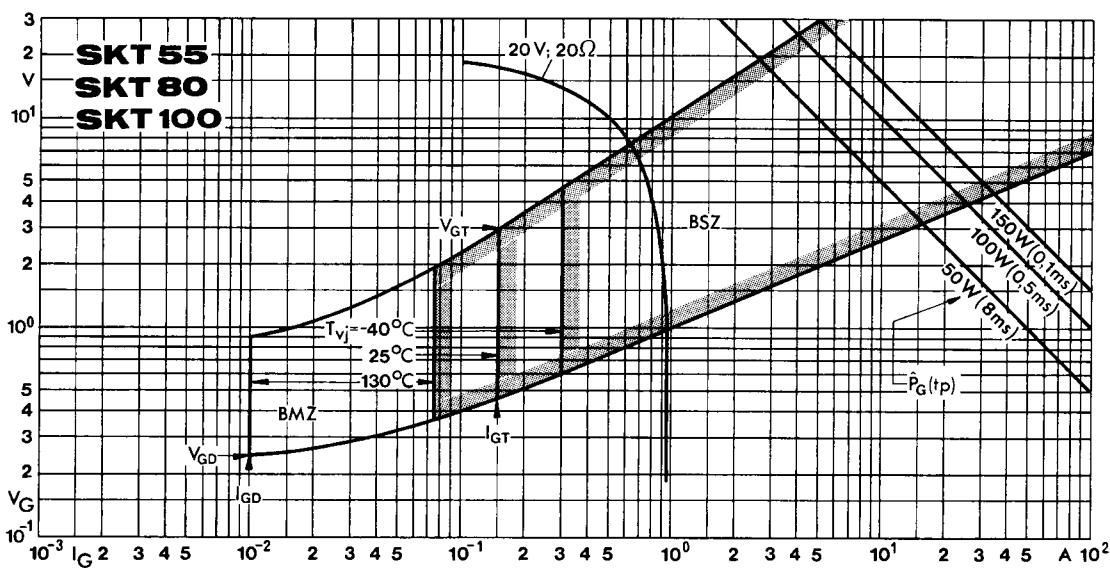

Fig. 9 Gate trigger characteristics

**SKT 55  
SKT 80  
SKT 100**

Case B 5

IEC-Publ. 191-2: (A 12 MA, A 12 U)

DIN 41892: (204 B 3)

BS 3934: SO - 30 C

JEDEC: TO - 209 (TO - 94)<sup>1)</sup>

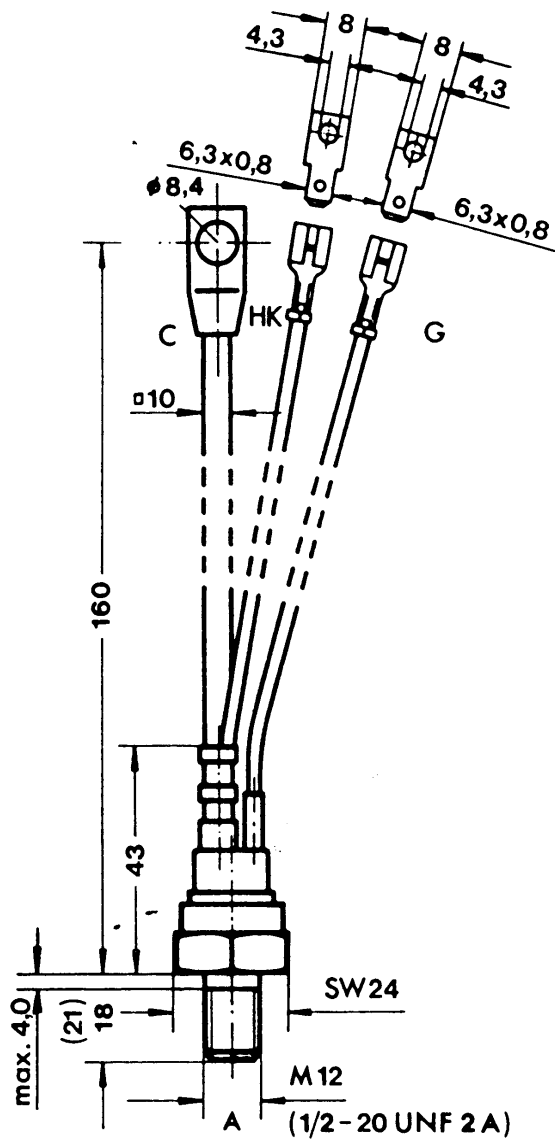

<sup>1)</sup> modified version. In the USA and Canada these types are available with the original TO-209 (TO-94) dimensions. TO-208 AD (TO-83) with flag terminals is also available.

**SKT 130  
SKT 160**

Case B 6

IEC-Publ. 191-2: A 47 MC

DIN 41893: 205 B 4

JEDEC: TO-209 (TO-93)

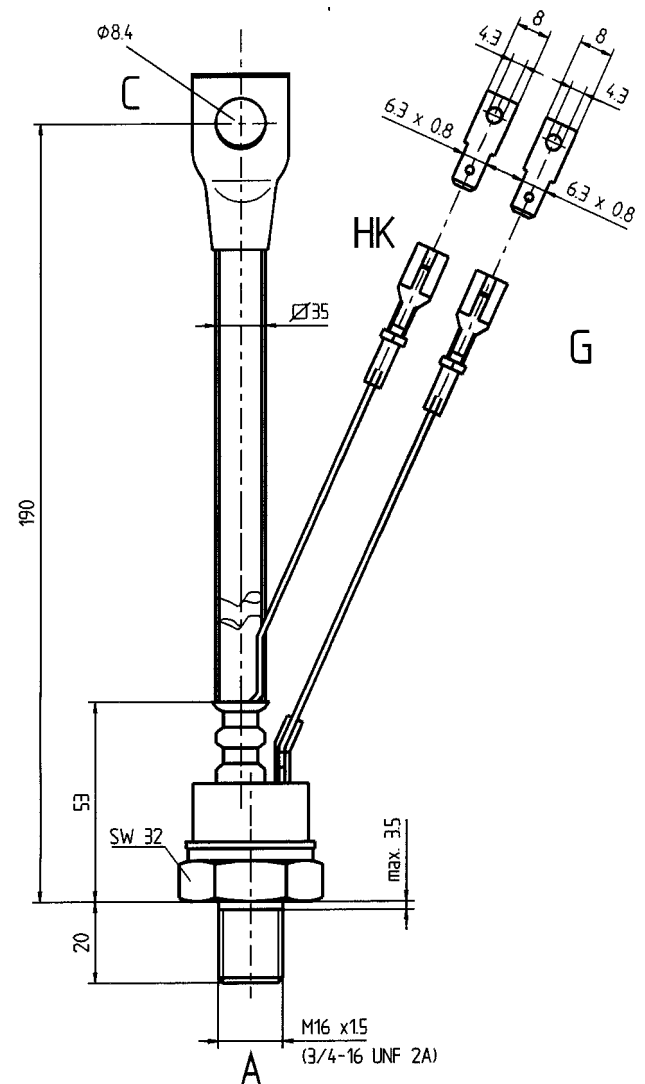

Dimensions in mm

- C: Cathode terminal (red sleeve)
- A: Anode terminal
- G: Gate terminal (yellow sleeve)
- HK: Auxiliary cathode terminal (red sleeve)