

PLASTIC-ENCAPSULATE VOLTAGE REGULATORS

FEATURES

- Maximum Output Current  $I_o$ : 0.1 A
- Output Voltage  $V_o$ : -5 V
- Continuous Total Dissipation  
 $P_D$ : 0.60 W ( $T_a = 25\text{ }^\circ\text{C}$ )
- Surface Mount device

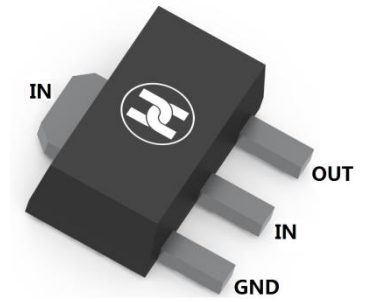

SOT-89

SCHEMATIC DIAGRAM

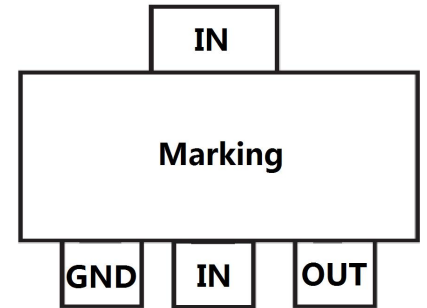
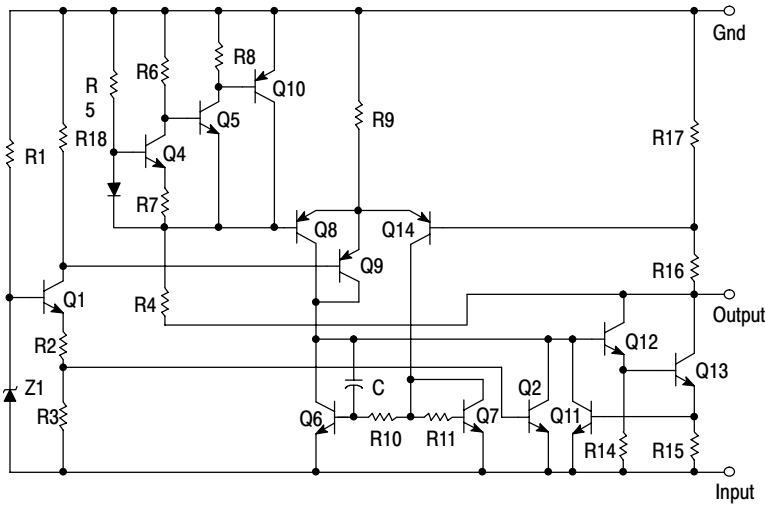

MECHANICAL DATA

- Case: SOT-89
- Case Material: Molded Plastic. UL flammability
- Classification Rating: 94V-0
- Weight: 0.055 grams (approximate)
- Marking: 79L05

MAXIMUM RATINGS (Operating temperature range applies unless otherwise specified)

Parameter	Symbol	Value	Unit
Input Voltage	$V_i$	-30	V
Power Dissipation	$P_D$	600	mW
Thermal Resistance from Junction to Ambient	$R_{\theta JA}$	208.3	$^\circ\text{C}/\text{W}$
Operating Temperature	$T_{opr}$	0~+150	$^\circ\text{C}$
Storage Temperature Range	$T_{STG}$	-55 ~+150	$^\circ\text{C}$

**PLASTIC-ENCAPSULATE VOLTAGE REGULATORS**
**ELECTRICAL CHARACTERISTICS AT SPECIFIED VIRTUAL JUNCTION TEMPERATURE**
**( $V_i = -10V, I_o = -40mA, C_i = 0.33\mu F, C_o = 0.1\mu F$ , unless otherwise specified )**

Parameter	Symbol	Min	Typ	Max	Unit	Conditions
Output voltage	$V_o$	-4.80	-5.0	-5.20	V	$T_J = +25^\circ C$
		-4.75	-5.0	-5.25	V	$-7V \leq V_i \leq -20V, I_o = 1mA \sim 40mA, 0^\circ C \leq T_J \leq +125^\circ C$
		-4.75	-5.0	-5.25	V	$-7V \leq V_i \leq -20V, I_o = 1mA \sim 70mA, 0^\circ C \leq T_J \leq +125^\circ C$
Load Regulation	$\Delta V_o$		20	60	mV	$I_o = 1mA \sim 100mA, T_J = +25^\circ C$
			10	30	mV	$I_o = 1mA \sim 40mA, T_J = +25^\circ C$
Line regulation	$\Delta V_o$		15	150	mV	$-7V \leq V_i \leq -20V$
			12	100	mV	$-8V \leq V_i \leq -20V, T_J = +25^\circ C$
Quiescent Current	$I_q$			6	mA	$T_J = +25^\circ C$
Quiescent Current Change	$\Delta I_q$			1.5	mA	$-8V \leq V_i \leq -20V, 0^\circ C \leq T_J \leq +125^\circ C$
				0.1	mA	$1mA \leq I_o \leq 40mA, 0^\circ C \leq T_J \leq +125^\circ C$
Output Noise Voltage	$V_N$		40		$\mu V/V_o$	$10Hz \leq f \leq 100kHz, T_J = +25^\circ C$
Ripple Rejection	RR	41	49		dB	$-8V \leq V_i \leq -20V, f = 120Hz, 0^\circ C \leq T_J \leq +125^\circ C$
Dropout Voltage	$V_d$		1.7		V	$T_J = +25^\circ C$

\*Pulse Test

**CLASSIFICATION OF  $V_o$** 

Rank	5%	4%	3%	2%
$V_o$ Range	-4.75~-5.25	-4.8~-5.20	-4.85~-5.15	-4.90~-5.10

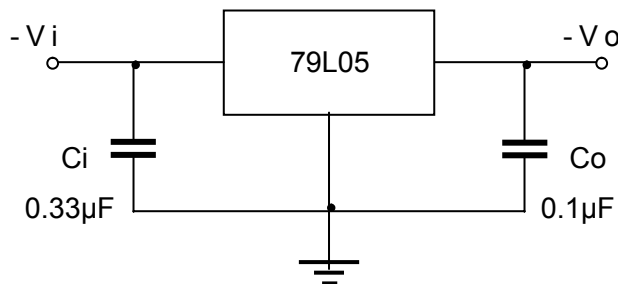
**TYPICAL APPLICATION**

Note: Bypass capacitors are recommended for optimum stability and transient response and should be located as close as Possible to the regulators.

PLASTIC-ENCAPSULATE VOLTAGE REGULATORS

Typical Characteristics

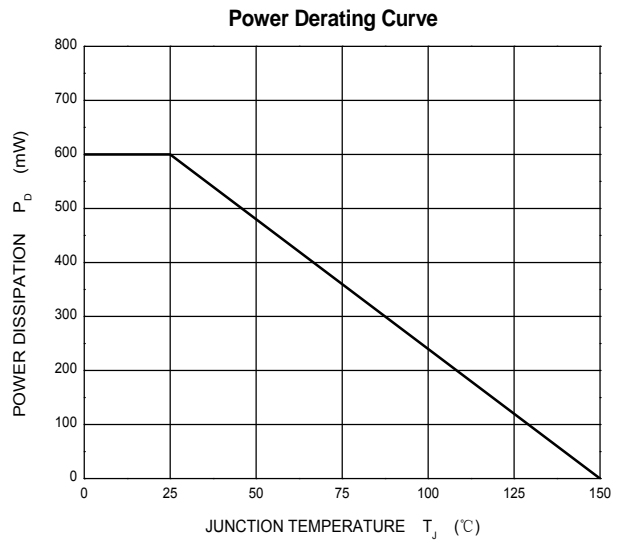
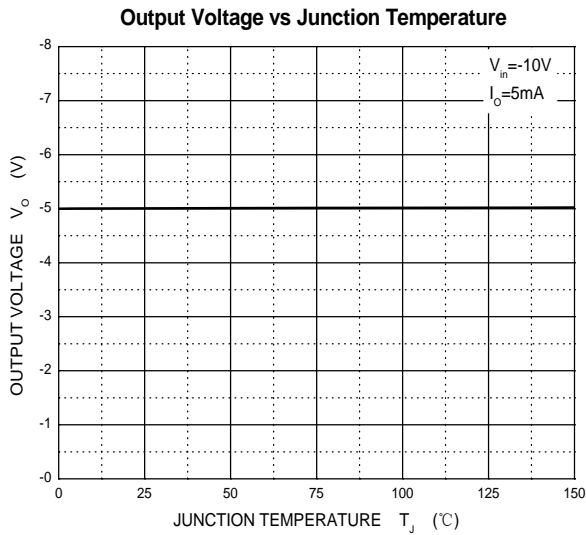
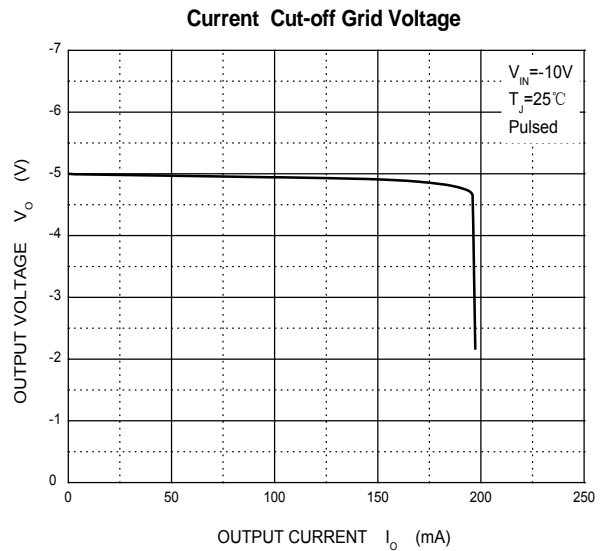
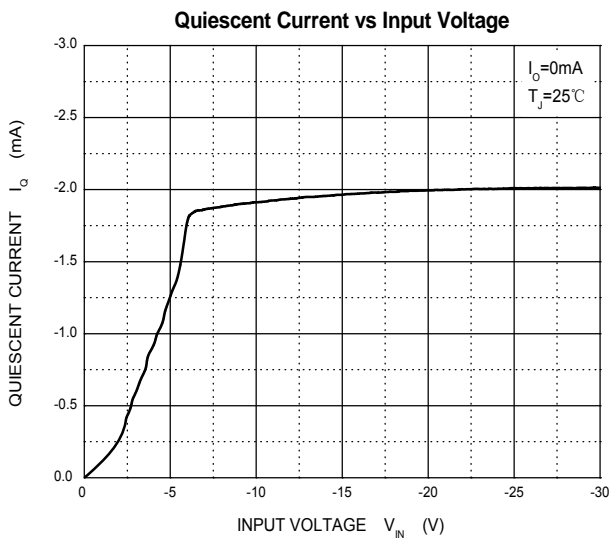
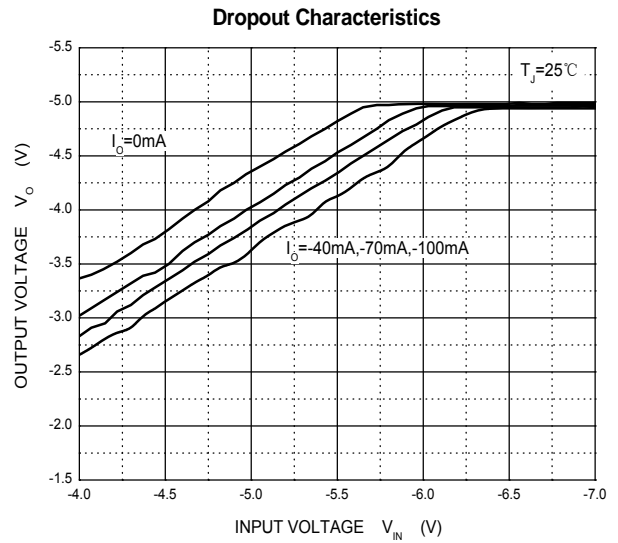
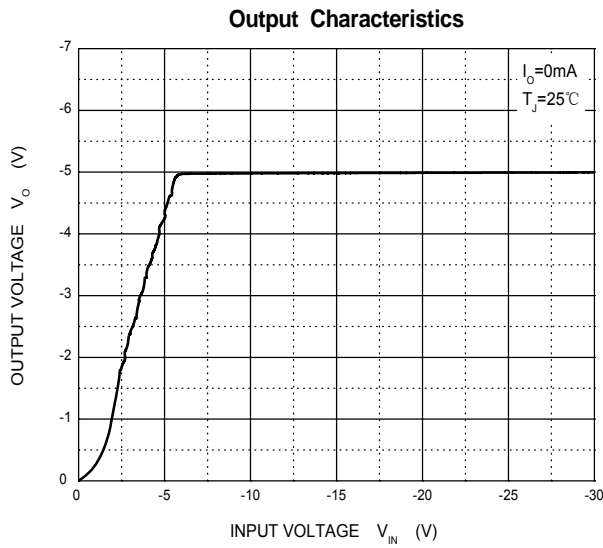

PLASTIC-ENCAPSULATE VOLTAGE REGULATORS

SOT-89 Package Outline Dimensions

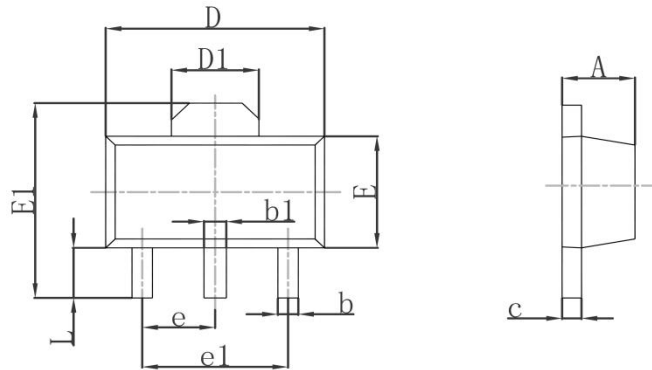

Symbol	Dimensions In Millimeters		Dimensions In Inches	
	Min.	Max.	Min.	Max.
A	1.400	1.600	0.055	0.063
b	0.320	0.520	0.013	0.020
b1	0.400	0.580	0.016	0.023
c	0.350	0.440	0.014	0.017
D	4.400	4.600	0.173	0.181
D1	1.550REF		0.061REF	
E	2.300	2.600	0.091	0.102
E1	3.940	4.250	0.155	0.167
e	1.500TYP		0.060TYP	
e1	3.000TYP		0.118TYP	
L	0.900	1.200	0.035	0.047

SOT-89 Suggested Pad Layout

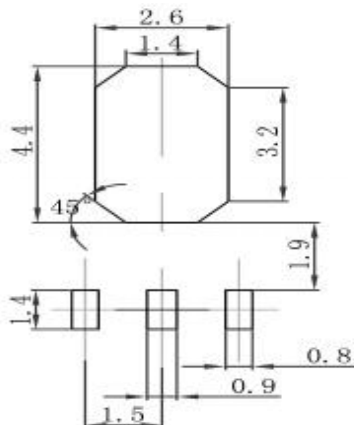

Note:

1. Controlling dimension: in millimeters
2. General tolerance:  $\pm 0.05\text{mm}$
3. The pad layout is for reference purposes only

PLASTIC-ENCAPSULATE VOLTAGE REGULATORS

SOT-89 Tape and Reel

SOT-89 Embossed Carrier Tape

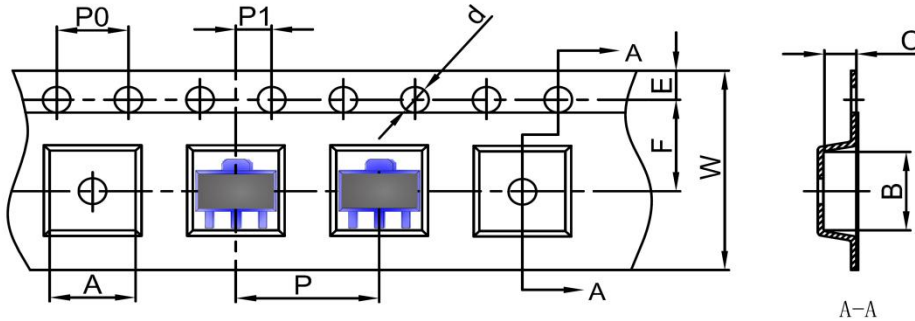

DIMENSIONS ARE IN MILLIMETER										
TYPE	A	B	C	d	E	F	P0	P	P1	W
SOT-89	4.85	4.45	1.85	Ø1.50	1.75	5.50	4.00	8.00	2.00	12.00
TOLERANCE	±0.1	±0.1	±0.1	±0.1	±0.1	±0.1	±0.1	±0.1	±0.1	±0.1

SOT-89 Tape Leader and Trailer

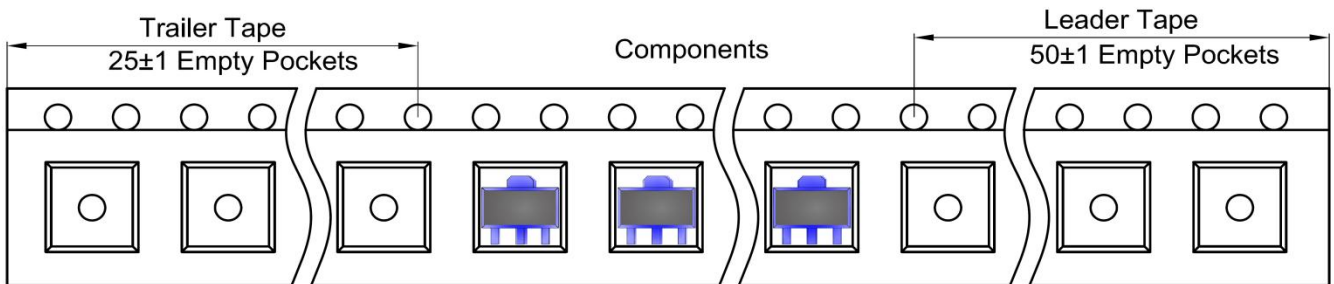

SOT-89 Reel

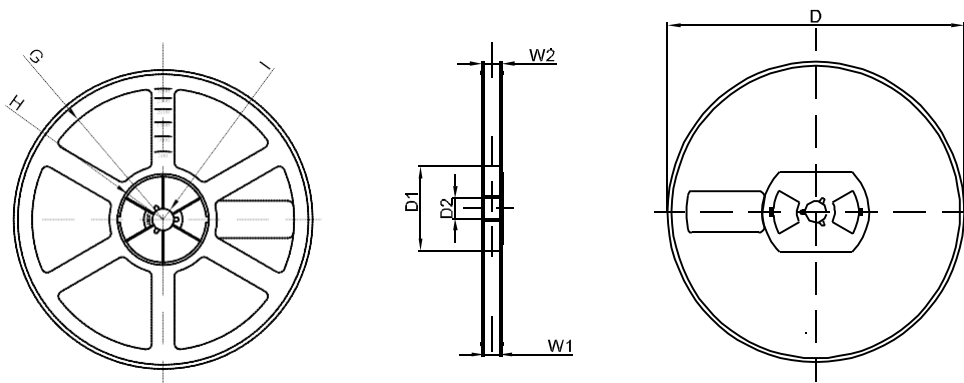

DIMENSIONS ARE IN MILLIMETER								
REEL OPTION	D	D1	D2	G	H	I	W1	W2
7" DIA	Ø178	54.40	13.00	R78	R25.60	R6.50	13.20	16.50
TOLERANCE	±2	±1	±1	±1	±1	±1	±1	±1