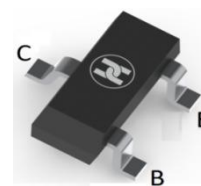
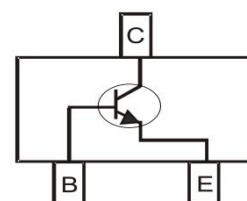

**BIPOLAR TRANSISTOR (NPN)**
**FEATURES**

- Complementary to SS8550
- Excellent  $h_{FE}$  Linearity
- High Collector Current
- Surface Mount device

**SOT-23**

**MECHANICAL DATA**

- Case: SOT-23
- Case Material: Molded Plastic. UL flammability
- Classification Rating: 94V-0
- Weight: 0.008 grams (approximate)

**MAXIMUM RATINGS ( $T_A = 25^\circ\text{C}$  unless otherwise noted)**

Parameter	Symbol	Value	Unit
Collector-Base Voltage	$V_{CB0}$	40	V
Collector-Emitter Voltage	$V_{CEO}$	25	V
Emitter-Base Voltage	$V_{EBO}$	5	V
Collector Current	$I_C$	1500	mA
Collector Power Dissipation	$P_C$	300	mW
Thermal Resistance From Junction To Ambient	$R_{\theta JA}$	417	$^\circ\text{C}/\text{W}$
Junction Temperature	$T_J$	150	$^\circ\text{C}$
Storage Temperature	$T_{STG}$	-55 ~+150	$^\circ\text{C}$

**ELECTRICAL CHARACTERISTICS ( $T_A = 25^\circ\text{C}$  unless otherwise specified)**

Parameter	Symbol	Min	Typ	Max	Unit	Conditions
Collector-base breakdown voltage	$V_{(BR)CB0}$	40			V	$I_C=100\mu\text{A}$ , $I_E=0$
Collector-emitter breakdown voltage	$V_{(BR)CEO}$	25			V	$I_C=0.1\text{mA}$ , $I_B=0$
Emitter-base breakdown voltage	$V_{(BR)EBO}$	5			V	$I_E=100\mu\text{A}$ , $I_C=0$
Collector cut-off current	$I_{CBO}$			0.1	$\mu\text{A}$	$V_{CB}=40\text{V}$ , $I_E=0$
Collector cut-off current	$I_{CEO}$			0.1	$\mu\text{A}$	$V_{CE}=20\text{V}$ , $I_B=0$
Emitter cut-off current	$I_{EBO}$			0.1	$\mu\text{A}$	$V_{EB}=5\text{V}$ , $I_C=0$
DC current gain	$h_{FE1}$	120		400		$V_{CE}=1\text{V}$ , $I_C=100\text{mA}$
	$h_{FE2}$	40				$V_{CE}=1\text{V}$ , $I_C=800\text{mA}$
Collector-emitter saturation voltage	$V_{CE(sat)}$			0.6	V	$I_C=500\text{mA}$ , $I_B=50\text{mA}$
Base-emitter saturation voltage	$V_{BE(sat)}$			1.2	V	$I_C=500\text{mA}$ , $I_B=50\text{mA}$
Transition frequency	$f_T$	100			MHz	$V_{CE}=10\text{V}$ , $I_C=50\text{mA}$ , $f=30\text{MHz}$

**CLASSIFICATION OF  $h_{FE}$** 

Rank	L	H	J
Range	120-200	200-350	300-400
Marking	Y1		

**BIPOLAR TRANSISTOR (NPN)**

**Typical Characteristics**

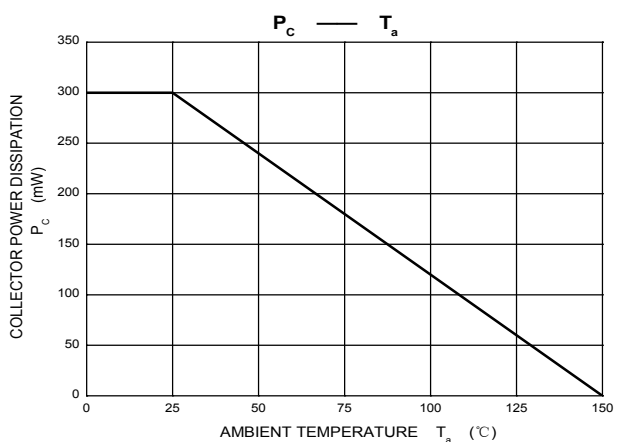
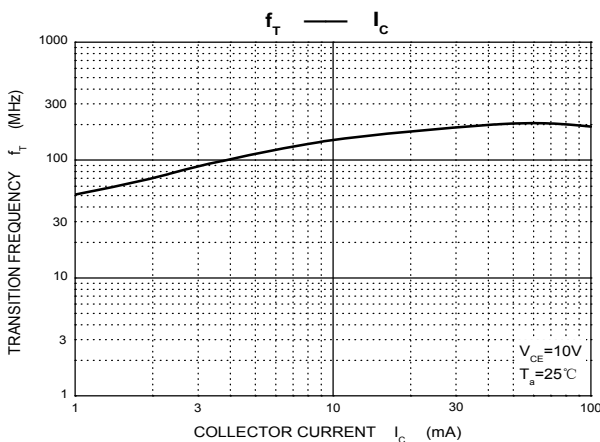
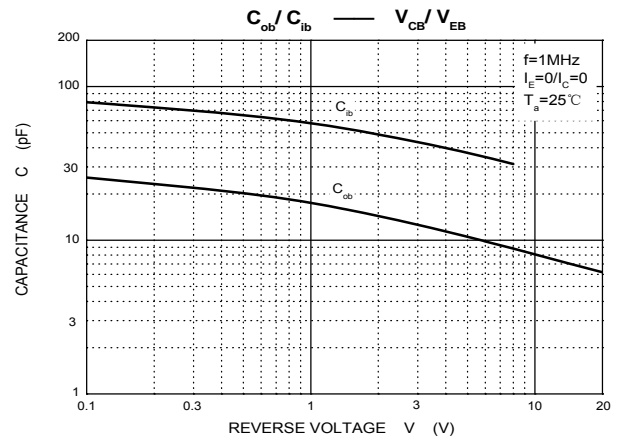
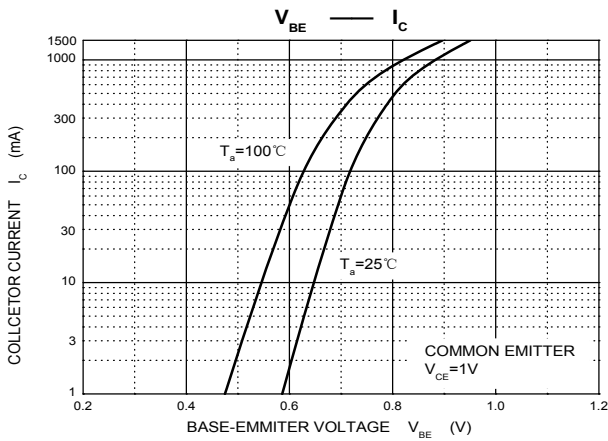
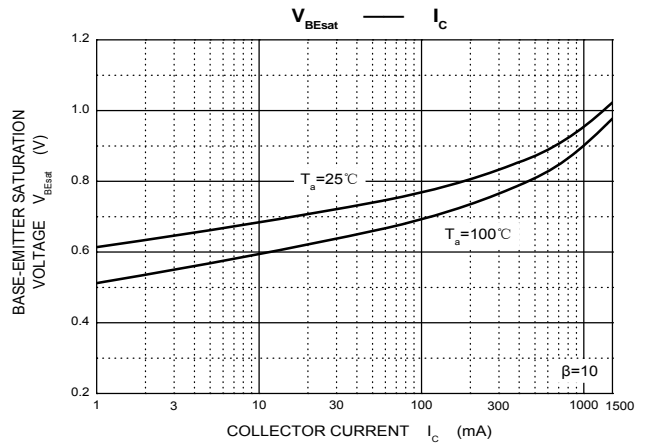
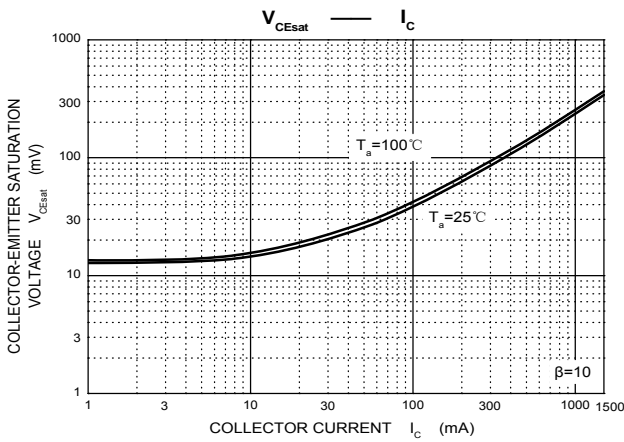
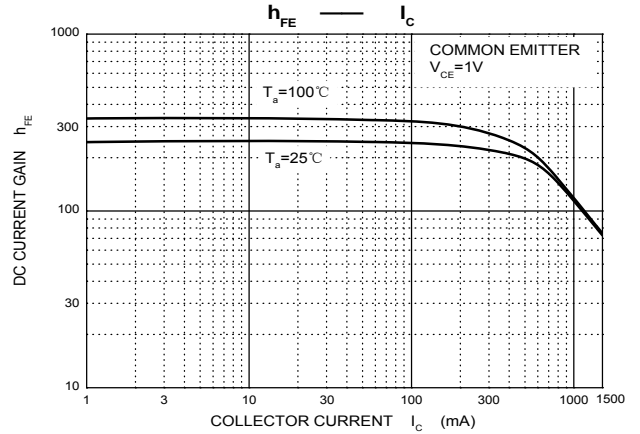
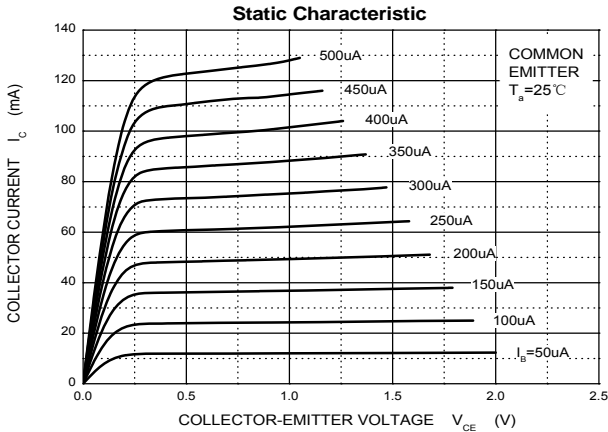

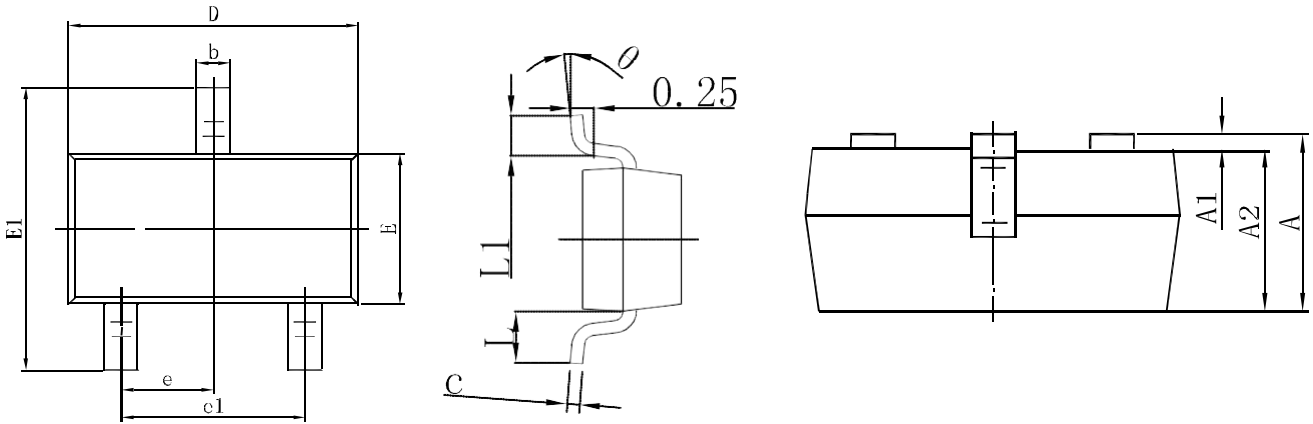
**BIPOLAR TRANSISTOR (NPN)**
**SOT-23 Package Outline Dimensions**

Symbol	Dimensions In Millimeters		Dimensions In Inches	
	Min.	Max.	Min.	Max.
A	0.900	1.150	0.035	0.045
A1	0.000	0.100	0.000	0.004
A2	0.900	1.050	0.035	0.041
b	0.300	0.500	0.012	0.020
c	0.080	0.150	0.003	0.006
D	2.800	3.000	0.110	0.118
E	1.200	1.400	0.047	0.055
E1	2.250	2.550	0.089	0.100
e	0.950 TYP		0.037 TYP	
e1	1.800	2.000	0.071	0.079
L	0.550 REF		0.022 REF	
L1	0.300	0.500	0.012	0.020
$\theta$	0°	8°	0°	8°

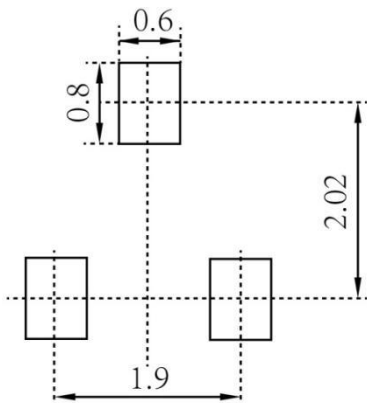
**SOT-23 Suggested Pad Layout**

**Note:**

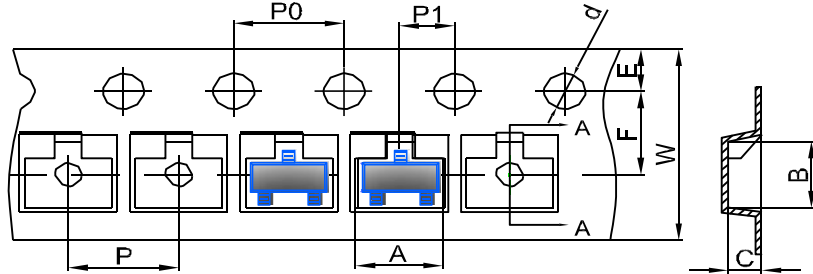
1. Controlling dimension: in millimeters
2. General tolerance:  $\pm 0.05\text{mm}$
3. The pad layout is for reference purposes only

**BIPOLAR TRANSISTOR (NPN)**
**SOT-23 Tape and Reel**
**SOT-23 Embossed Carrier Tape**

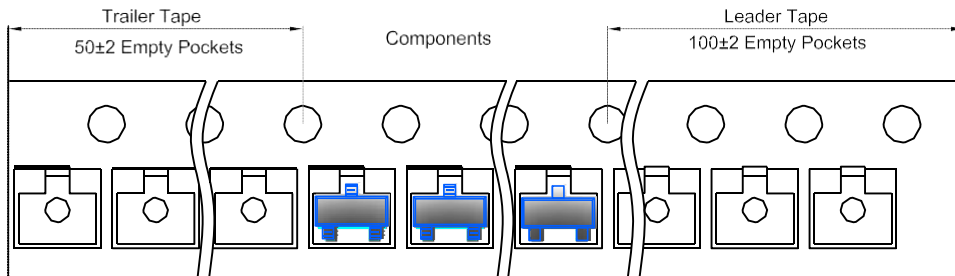
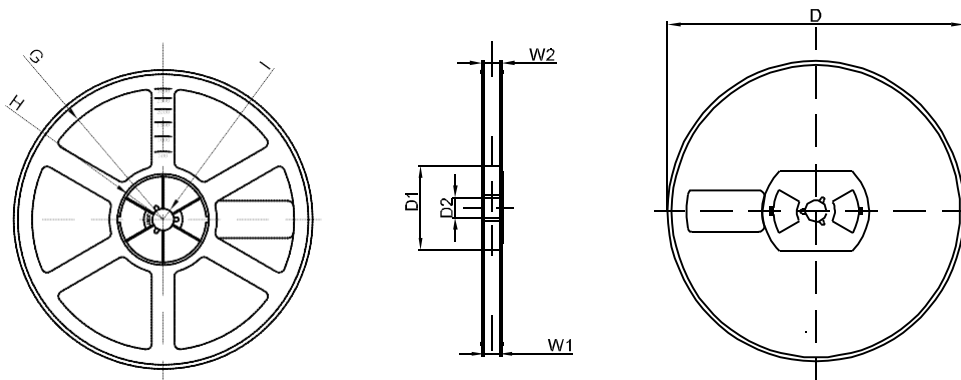
DIMENSIONS ARE IN MILLIMETER										
TYPE	A	B	C	d	E	F	P0	P	P1	W
SOT-23	3.15	2.77	1.22	Ø1.50	1.75	3.50	4.00	4.00	2.00	8.00
TOLERANCE	±0.1	±0.1	±0.1	±0.1	±0.1	±0.1	±0.1	±0.1	±0.1	±0.1

**SOT-23 Tape Leader and Trailer**

**SOT-23 Reel**

DIMENSIONS ARE IN MILLIMETER								
REEL OPTION	D	D1	D2	G	H	I	W1	W2
7" DIA	Ø178	54.40	13.00	R78	R25.60	R6.50	9.50	12.30
TOLERANCE	±2	±1	±1	±1	±1	±1	±1	±1