



Step-Down, High Efficiency, 1A LED Driver

Features

- Maximum 1A constant output current
- 97% efficiency @ input voltage 12V, 350mA, 3-LED
- 6~36V input voltage range
- Hysteretic PFM eliminates external compensation design
- Settable constant output current
- Integrated power switch with 0.3ohm low Rds(on)
- Full protections: Start-Up/OCP/ Thermal/ LED Open-/ Short-Circuit
- Only 5 external components required

Product Description

MBI6655 is a step-down constant-current high-brightness LED driver to provide a cost-effective design solution for interior/exterior illumination applications. It is designed to deliver constant current to light up high power LED with minimum 5 external components. With hysteretic PFM control scheme, MBI6655 eliminates external compensation design and simplifies the PCB design.

The output current of MBI6655 can be programmed by an external resistor and dimmed via pulse width modulation (PWM) through DIM pin. MBI6655 features complete protection design to handle faulty situations. The start-up function limits the inrush current while the power is switched on. Over temperature protection (OTP), and over current protection (OCP) guard the system to be robust and keep the driver away from being damaged which results from LED open-circuited, short-circuited and other abnormal events.

MBI6655 provides thermal-enhanced SOT-89 and SOP-8 packages as well to handle power dissipation efficiently.

Applications

- Signage and Decorative LED Lighting
- High Power LED Lighting
- Constant Current Source

Small Outline Transistor

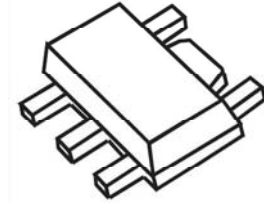

GSB: SOT-89-5L

Small Outline Package

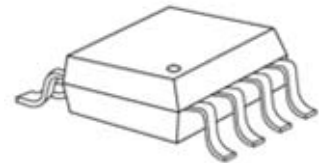

GD: SOP8L-150-1.27

MBI6655

Step-Down, 1A LED Driver

Typical Application Circuit

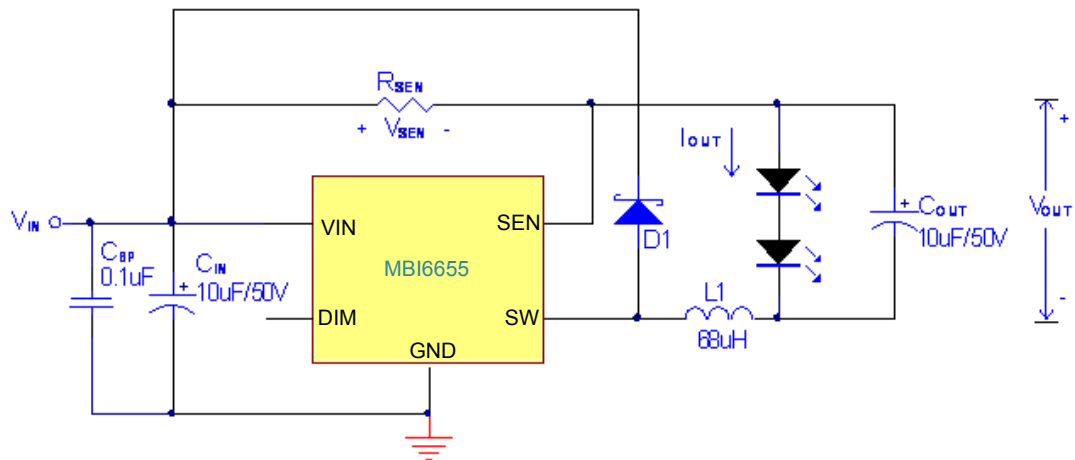

- R_{SEN}: Viking, 0.14Ω, 1206, ±1% SMD Resistor
- C_{IN}: GOLDENCONNECTIONS, 10uF/50V, 5*11, DIP, electrolytic capacitor
- C_{OUT} (Optional): GOLDENCONNECTIONS, 10uF/50V, 5*11, DIP, electrolytic capacitor
C_{OUT} is required for output hot plug protection
- C_{BP}: GOLDENCONNECTIONS, 0.1uF/50V, X5R, 0603 SMD ceramic capacitor
- L1: GANG SONG, GSDS106C2-680M
- D1: ZOWIE, SSCD206

Fig. 1

Functional Diagram

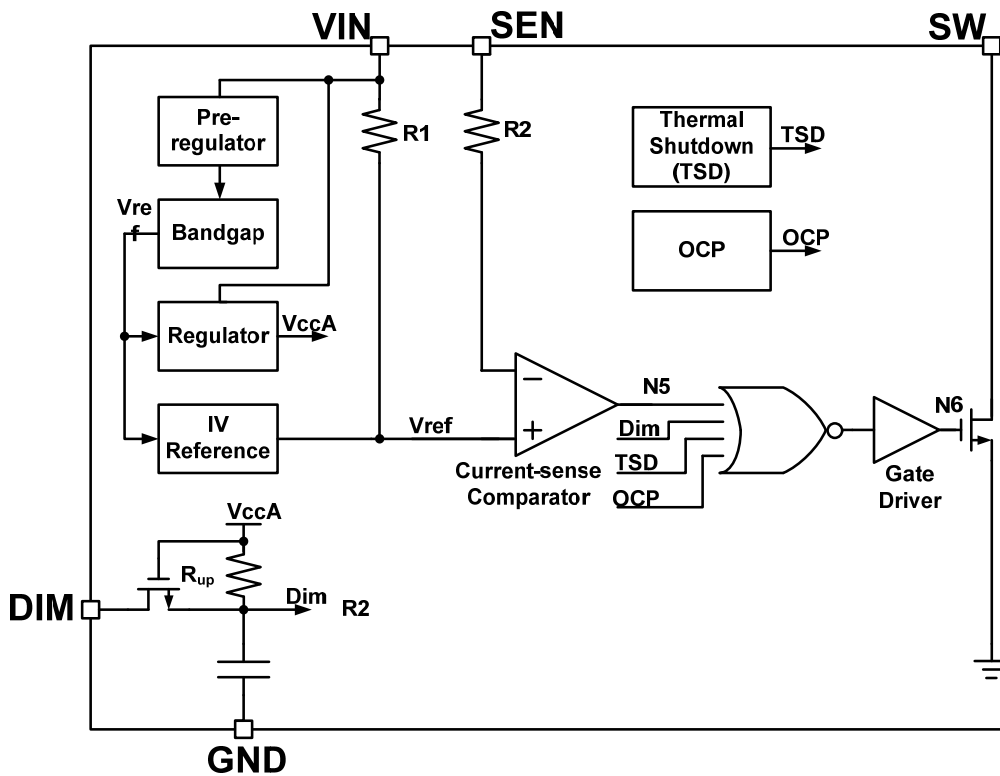
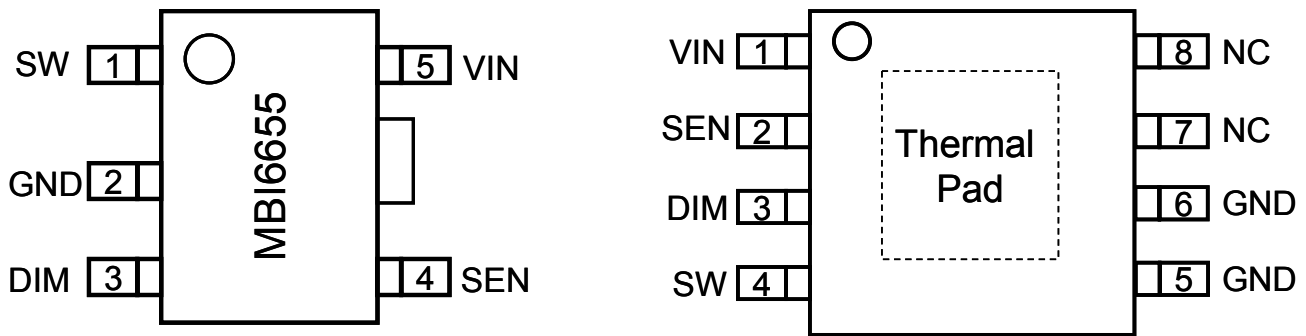

Fig. 2

MBI6655**Step-Down, 1A LED Driver**

Pin Configuration



Pin Description

Pin Name	Function
GND	Ground terminal for control logic and current sink
SW	Switch output terminal
DIM	Dimming control terminal
SEN	Output current sense terminal
VIN	Supply voltage terminal
Thermal Pad	Power dissipation terminal connected to GND*

*To improve the noise immunity, the thermal pad is suggested to connect to GND on PCB. In addition, when a heat-conducting copper foil on PCB is soldered with thermal pad, the desired thermal conductivity will be improved.

MBI6655**Step-Down, 1A LED Driver****Maximum Ratings**

Operation above the maximum ratings may cause device failure. Operation at the extended periods of the maximum ratings may reduce the device reliability.

Characteristic		Symbol	Rating	Unit
Supply Voltage		V_{IN}	0~40	V
Output Current		I_{OUT}	1.2	A
Sustaining Voltage at DIM pin		V_{DIM}	-0.3~40	V
Sustaining Voltage at SW pin		V_{SW}	-0.3~40	V
GND Terminal Current		I_{GND}	1.2	A
Power Dissipation (On 4 Layer PCB, $T_a=25^\circ\text{C}$)*	GD Type	P_D	3.13	W
Thermal Resistance (By simulation, on 4 Layer PCB)*		$R_{th(j-a)}$	40	$^\circ\text{C/W}$
Empirical Thermal Resistance (On PCB**, $T_a=25^\circ\text{C}$)			75.1	$^\circ\text{C/W}$
Power Dissipation (On 4 Layer PCB, $T_a=25^\circ\text{C}$)*	GSB Type	P_D	1.77	W
Thermal Resistance (By simulation, on 4 Layer PCB)*		$R_{th(j-a)}$	-	$^\circ\text{C/W}$
Empirical Thermal Resistance (On PCB**, $T_a=25^\circ\text{C}$)			70.8	$^\circ\text{C/W}$
Operating Junction Temperature		$T_{j,max}$	150***	$^\circ\text{C}$
Operating Temperature		T_{opr}	-40~+85	$^\circ\text{C}$
Storage Temperature		T_{stg}	-55~+150	$^\circ\text{C}$

*The PCB size is 76.2mm*114.3mm in simulation. Please refer to JEDEC JESD51.

** The PCB area is 4 times larger than that of IC's and without extra heat sink.

*** Operation at the maximum rating for extended periods may reduce the device reliability; therefore, the suggested operation temperature of the device (T_{opr}) is under 125°C .

Note: The performance of thermal dissipation is strongly related to the size of thermal pad, thickness and layer numbers of the PCB. The empirical thermal resistance may be different from simulative value. Users should plan for expected thermal dissipation performance by selecting package and arranging layout of the PCB to maximize the capability.

MBI6655**Step-Down, 1A LED Driver**

Electrical Characteristics

Test condition: $V_{IN}=12V$, $V_{OUT}=3.6V$, $L1=68\mu H$, $C_{IN}=C_{OUT}=10\mu F$, $T_A=25^\circ C$; unless otherwise specified. Please refer to test circuit (a) of Fig. 3.)

Characteristics		Symbol	Condition	Min.	Typ.	Max.	Unit
Supply Voltage		V_{IN}	-	6	-	36	V
Supply Current		I_{IN}	$V_{IN}=6V\sim 36V$	1	1.3	1.5	mA
Output Current		I_{OUT}	-	-	350	1000	mA
Output Current Accuracy		dI_{OUT}/I_{OUT}	$150mA \leq I_{OUT} \leq 1000mA$,	-	± 3	± 5	%
Minimum SW Dropout Voltage		ΔV_{SW}	$I_{OUT}=1A$	-	0.3	-	V
Internal Propagation Delay Time		T_{pd}	$V_{IN}=12V$	100	150	300	ns
Efficiency		-	$V_{IN}=12V$, $I_{OUT}=350mA$, $V_{OUT}=10.8V$	-	96	-	%
DIM Input Voltage	"H" level	V_{IH}	-	2.7	-	-	V
	"L" level	V_{IL}	-	-	-	0.5	V
Switch ON Resistance		$R_{ds(on)}$	$V_{IN}=12V$; refer to test circuit (b)	0.2	0.3	0.4	Ω
Minimum Switch ON Time*		$T_{ON,min}$	$V_{IN}=12V$,	30	50	100	ns
Minimum Switch OFF Time*		$T_{OFF,min}$	$V_{IN}=12V$,	30	50	100	ns
Recommended Duty Cycle Range of SW*		D_{sw}	-	20	-	80	%
Operating Frequency Range		$Freq_{Max}$	-	40	-	1000	kHz
CURRENT SENSE							
Mean SEN Voltage		V_{SEN}	$V_{IN}=12V$, $V1=1V$, refer to test circuit (c)	95	100	105	mV
THERMAL OVERLOAD							
Thermal Shutdown Threshold*		T_{SD}	-	145	165	175	$^\circ C$
Thermal Shutdown Hysteresis*		T_{SD-HYS}	-	20	30	40	$^\circ C$
OVER CURRENT PROTECTION							
Over Current Threshold*		I_{ocp}	$V_{IN}=36V$	-	1.8	2	A
DIMMING							
Duty Cycle Range of PWM Signal Applied to DIM pin		$Duty_{DIM}$	PWM Frequency: 1KHz	1	-	100	%

*Parameters are not tested at production. Parameters are guaranteed by design.

MBI6655

Step-Down, 1A LED Driver

Test Circuit for Electrical Characteristics

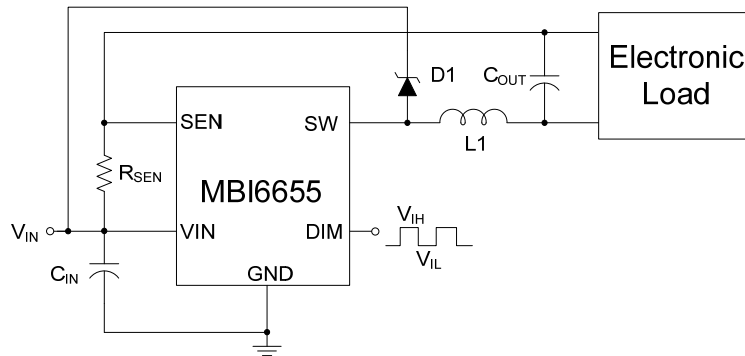

(a)

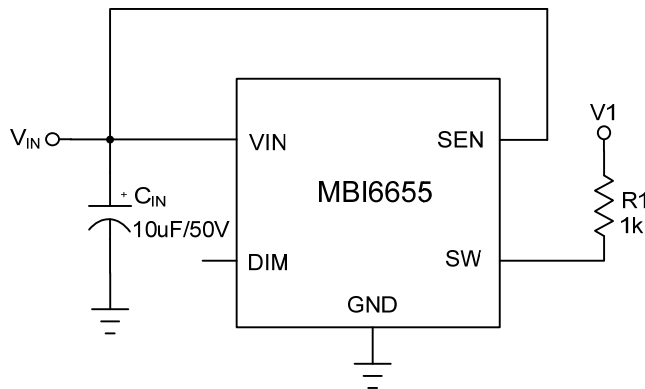

(b)

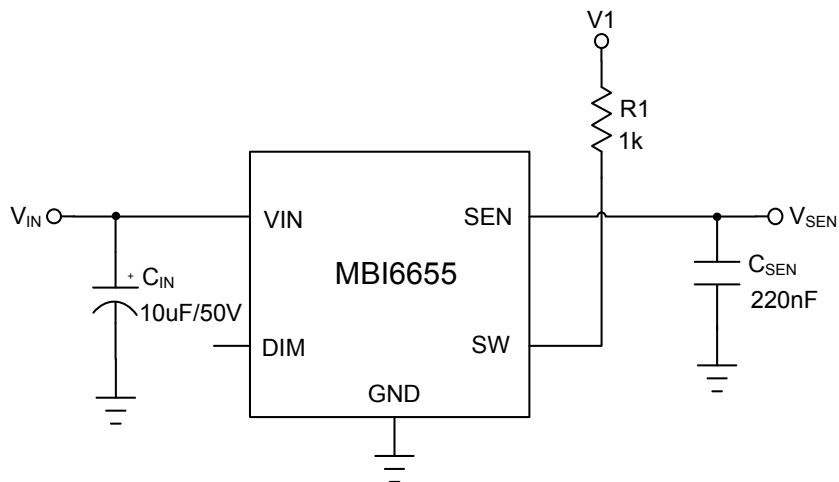

(c)

Fig. 3

MBI6655

Step-Down, 1A LED Driver

Typical Performance Characteristics

Please refer to Typical Application Circuit, $V_{IN}=12V$, $L1=68\mu H$, $C_{IN}=C_{OUT}=10\mu F$, $T_A=25^\circ C$, unless otherwise specified.

LED $V_F=3.6V$; 2-LED $V_F=7.2V$; 3-LED $V_F=10.8V$; 4-LED $V_F=14.4V$; 5-LED $V_F=18V$

1. Efficiency vs. Input Voltage at Various LED Cascaded Numbers

Efficiency vs. input voltage @ $L1=22\mu H$

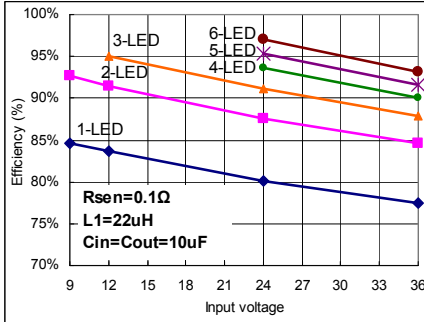

$I_{OUT}=1A$

Fig. 4

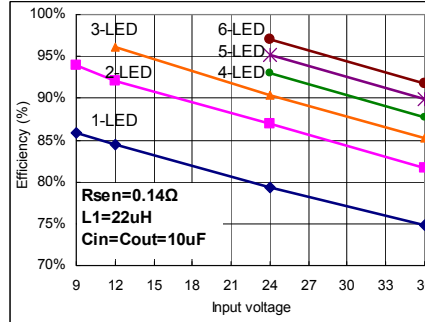

$I_{OUT}=700mA$

Fig. 5

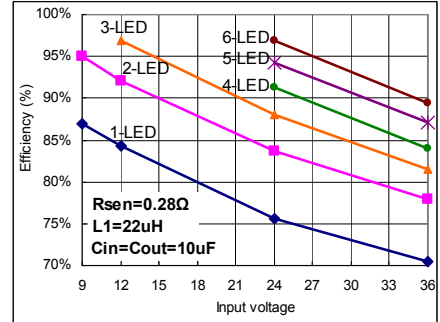

$I_{OUT}=350mA$

Fig. 6

Efficiency vs. input voltage @ $L1=68\mu H$

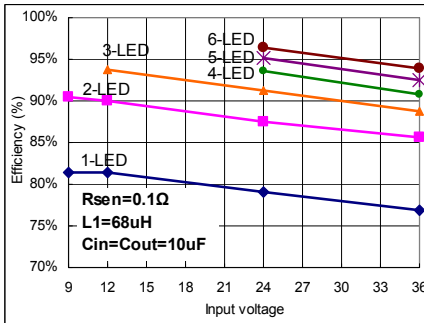

$I_{OUT}=1A$

Fig. 7

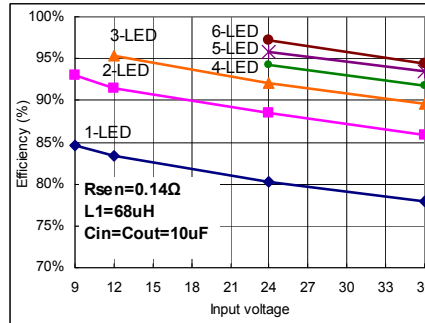

$I_{OUT}=700mA$

Fig. 8

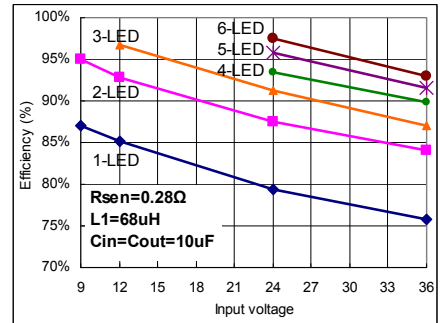

$I_{OUT}=350mA$

Fig. 9

Efficiency vs. input voltage @ $L1=100\mu H$

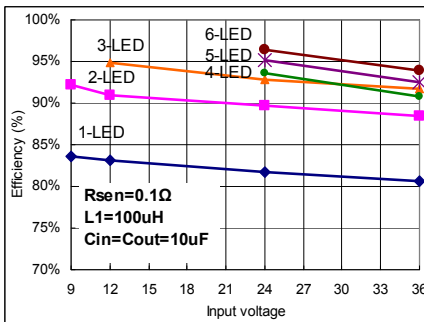

$I_{OUT}=1A$

Fig. 10

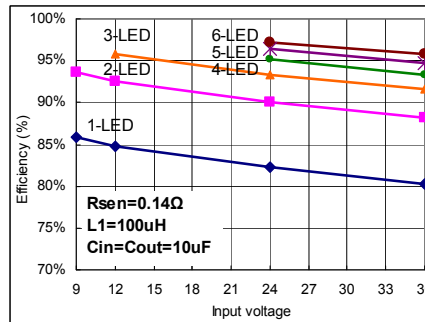

$I_{OUT}=700mA$

Fig. 11

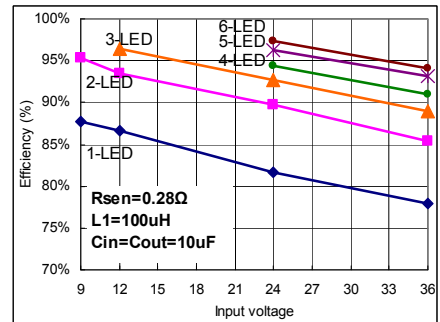

$I_{OUT}=350mA$

Fig. 12

MBI6655

Step-Down, 1A LED Driver

2. Efficiency vs. LED Cascaded Numbers at Various Input Voltage

Efficiency vs. LED cascaded number @ L1=22uH

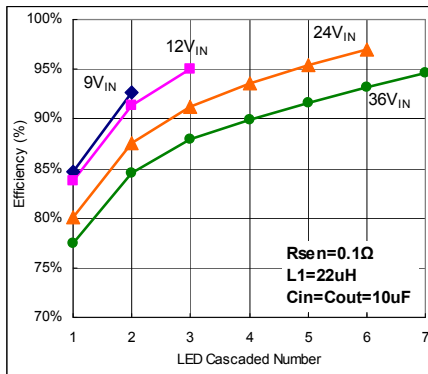

I_{OUT}=1A

Fig. 13

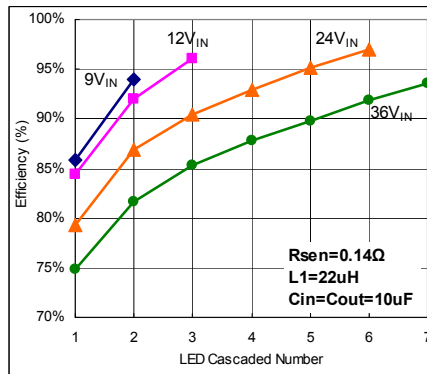

I_{OUT}=700mA

Fig. 14

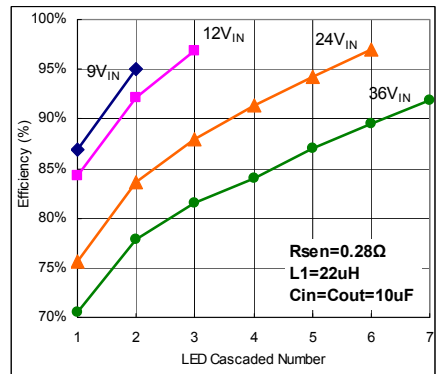

I_{OUT}=350mA

Fig. 15

Efficiency vs. LED cascaded number @ L1=68uH

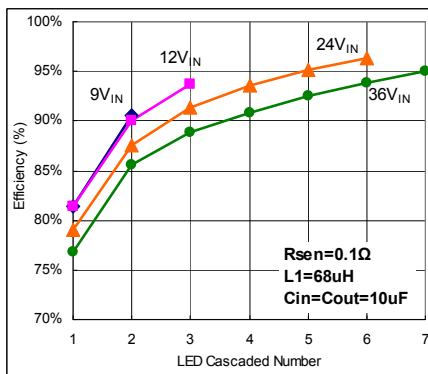

I_{OUT}=1A

Fig. 16

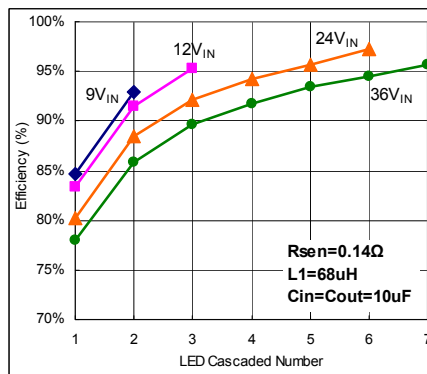

I_{OUT}=700mA

Fig. 17

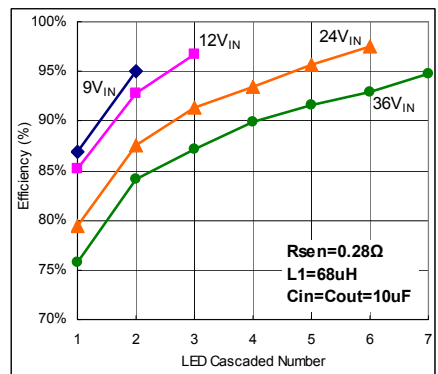

I_{OUT}=350mA

Fig. 18

Efficiency vs. LED cascaded number @ L1=100uH

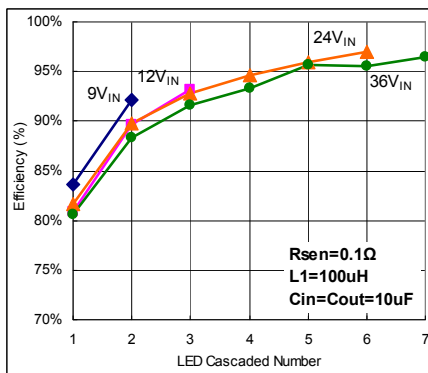

I_{OUT}=1A

Fig. 19

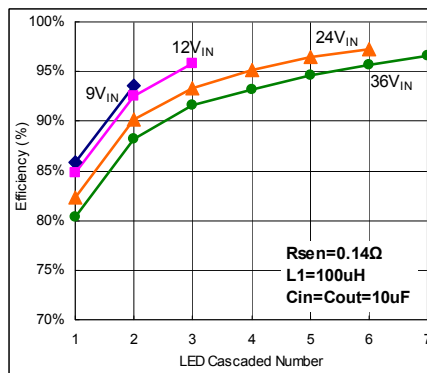

I_{OUT}=700mA

Fig. 20

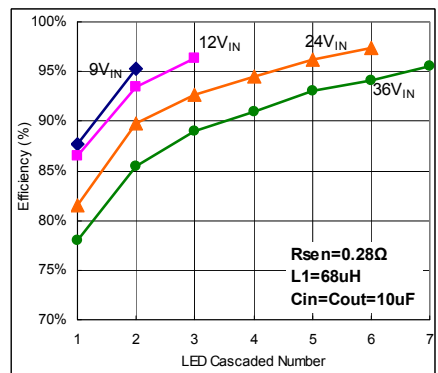

I_{OUT}=350mA

Fig. 21

MBI6655

Step-Down, 1A LED Driver

3. Output Current vs. Input Voltage at Various LED Cascaded Numbers

Output current vs. input voltage @ L1=22uH

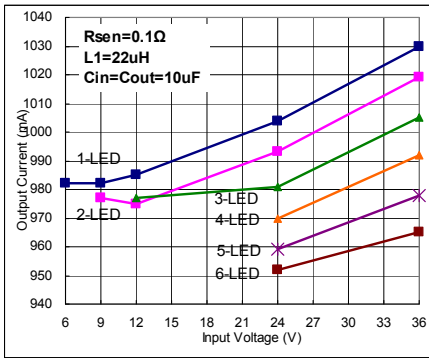

$I_{OUT}=1A$
Fig. 22

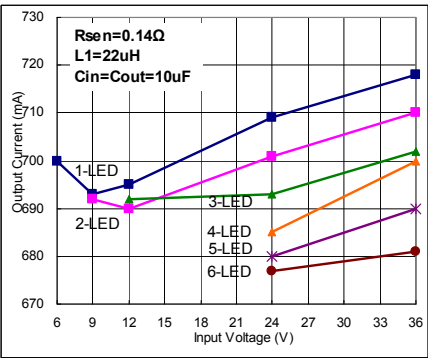

$I_{OUT}=700mA$
Fig. 23

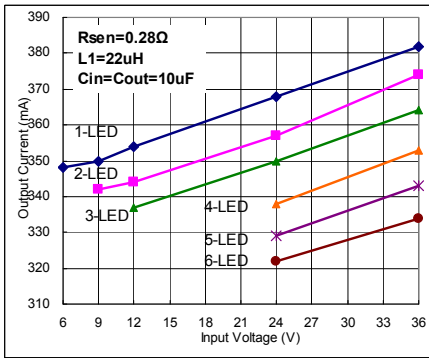

$I_{OUT}=350mA$
Fig. 24

Output current vs. input voltage @ L1=68uH

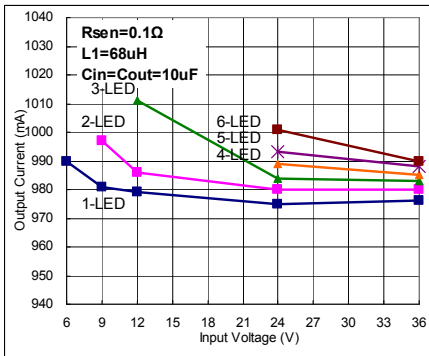

$I_{OUT}=1A$
Fig. 25

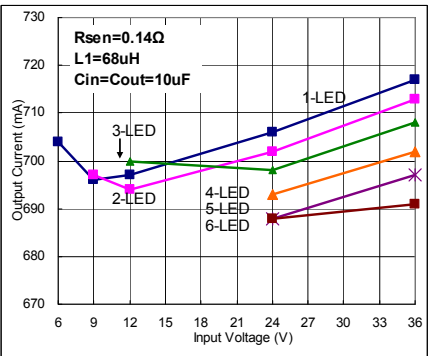

$I_{OUT}=700mA$
Fig. 26

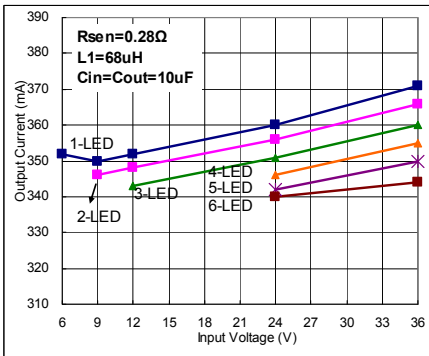

$I_{OUT}=350mA$
Fig. 27

Output current vs. input voltage @ L1=100uH

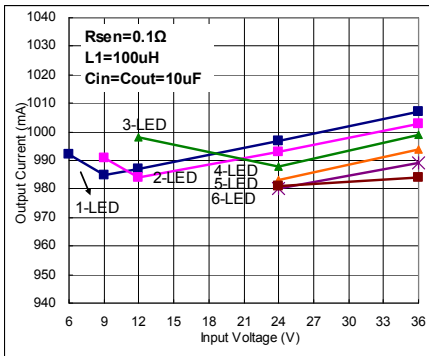

$I_{OUT}=1A$
Fig. 28

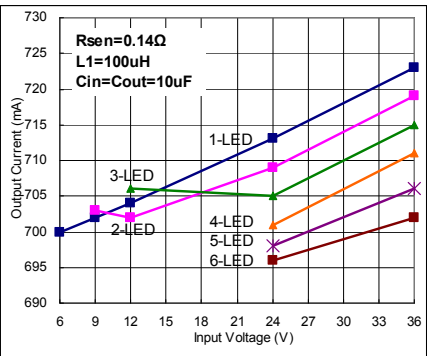

$I_{OUT}=700mA$
Fig. 29

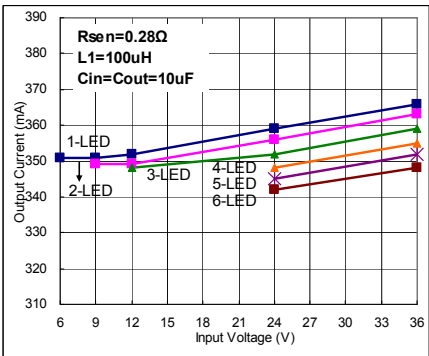

$I_{OUT}=350mA$
Fig. 30

MBI6655

Step-Down, 1A LED Driver

4. Output Current vs. Input Voltage at Various Inductors

Output current vs. input voltage @ 1-LED in cascaded

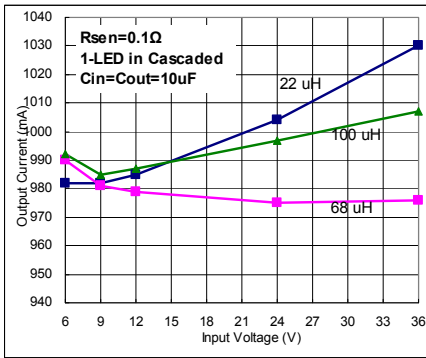

I_{OUT}=1A
Fig. 31

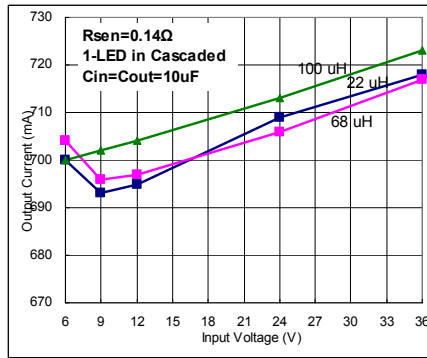

I_{OUT}=700mA
Fig. 32

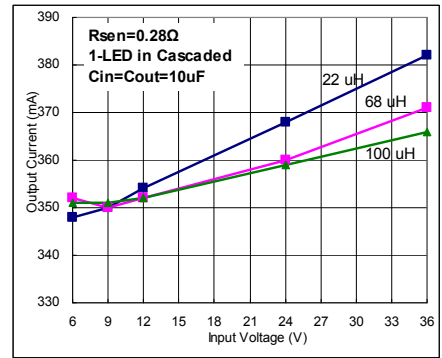

I_{OUT}=350mA
Fig. 33

Output current vs. input voltage @ 2-LED in cascaded

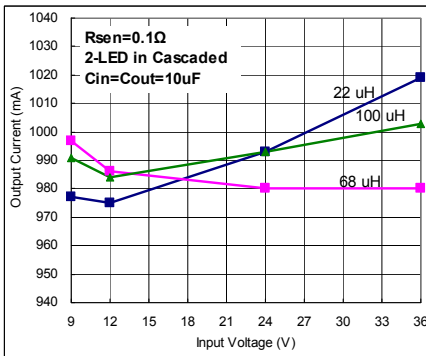

I_{OUT}=1A
Fig. 34

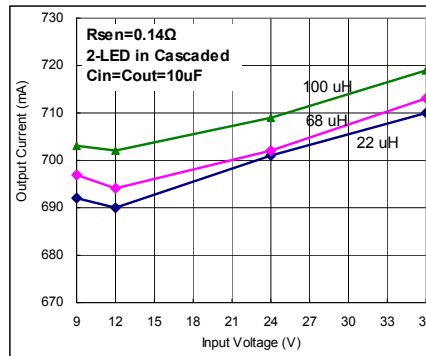

I_{OUT}=700mA
Fig. 35

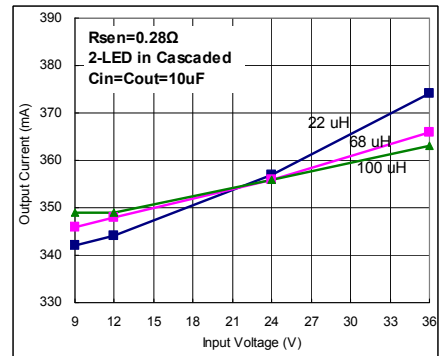

I_{OUT}=350mA
Fig. 36

Output current vs. input voltage @ 3-LED in cascaded

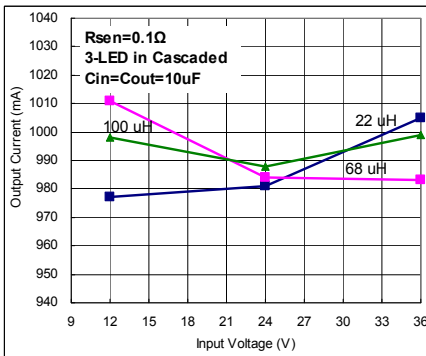

I_{OUT}=1A
Fig. 37

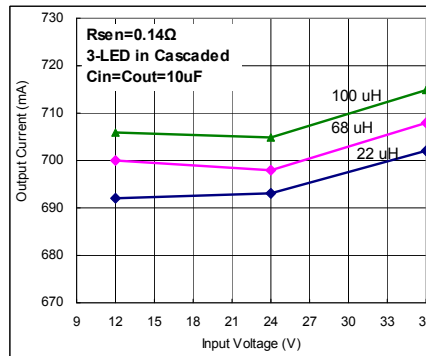

I_{OUT}=700mA
Fig. 38

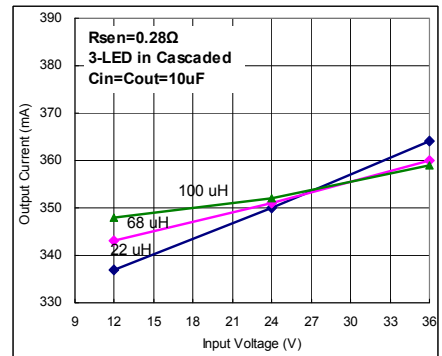

I_{OUT}=350mA
Fig. 39

MBI6655

Step-Down, 1A LED Driver

5. Output Current vs. LED Cascaded Number at Various Input Voltage

Output current vs. LED cascaded number @ L1=22uH

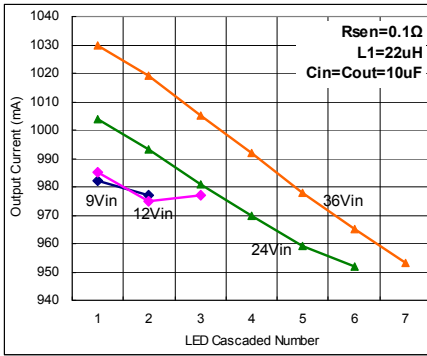

I_{OUT}=1A
Fig. 40

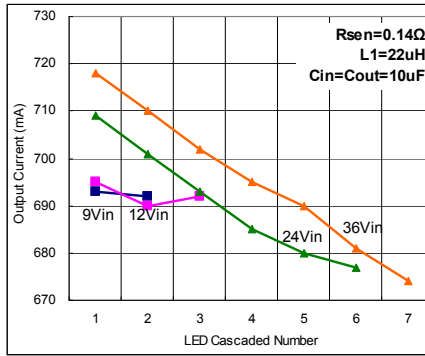

I_{OUT}=700mA
Fig. 41

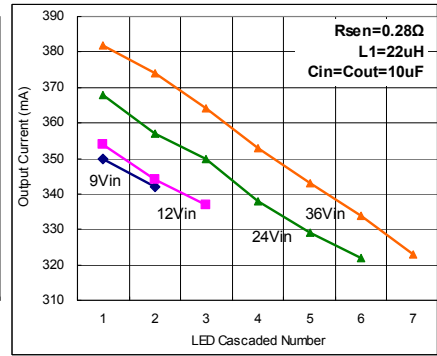

I_{OUT}=350mA
Fig. 42

Output current vs. LED cascaded number @ L1=68uH

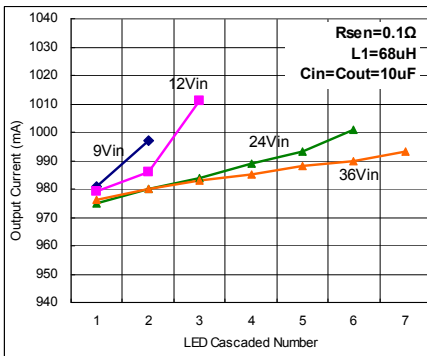

I_{OUT}=1A
Fig. 43

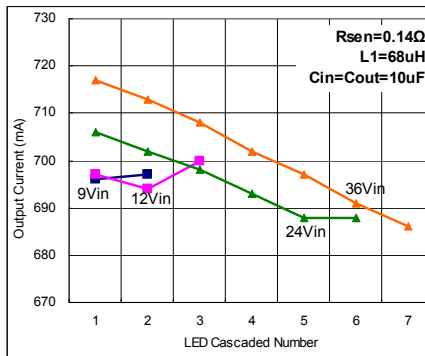

I_{OUT}=700mA
Fig. 44

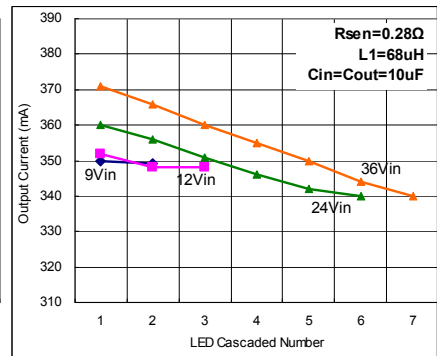

I_{OUT}=350mA
Fig. 45

Output current vs. LED cascaded number @ L1=100uH

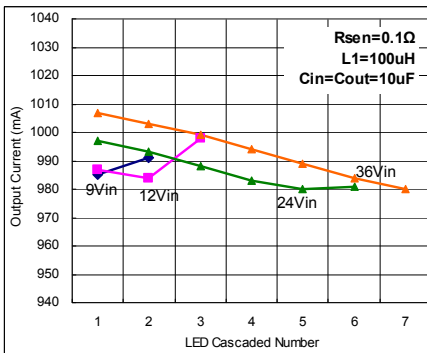

I_{OUT}=1A
Fig. 46

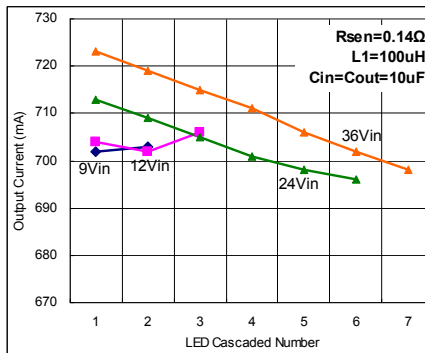

I_{OUT}=700mA
Fig. 47

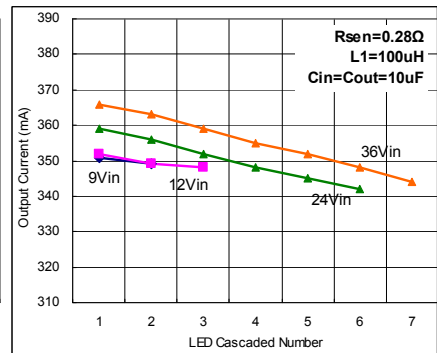

I_{OUT}=350mA
Fig. 48

MBI6655

Step-Down, 1A LED Driver

6. Output Current vs. LED Cascaded Number at Various Inductor

Output current vs. LED cascaded number @ $V_{IN}=12V$

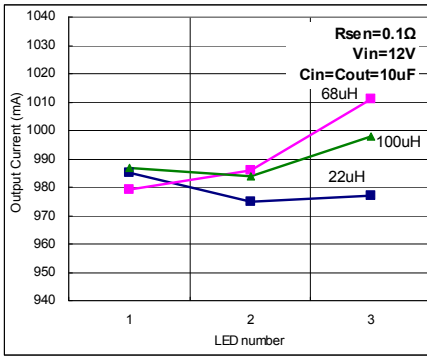

$I_{OUT}=1A$
Fig. 49

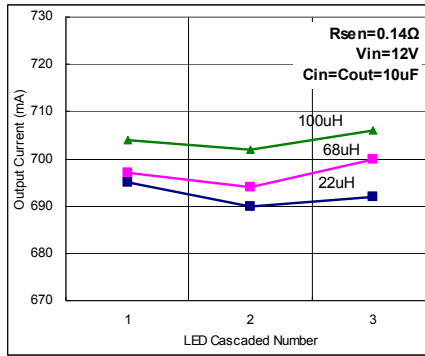

$I_{OUT}=700mA$
Fig. 50

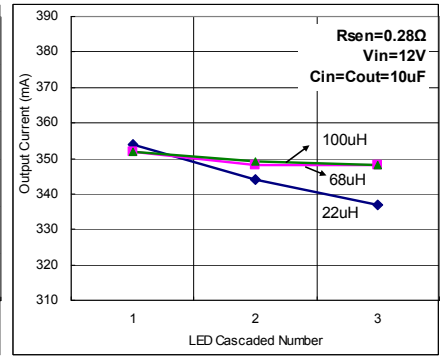

$I_{OUT}=350mA$
Fig. 51

Output current vs. LED cascaded number @ $V_{IN}=24V$

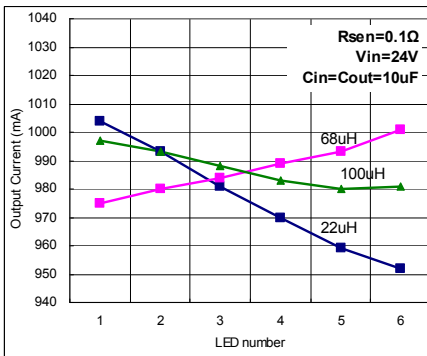

$I_{OUT}=1A$
Fig. 52

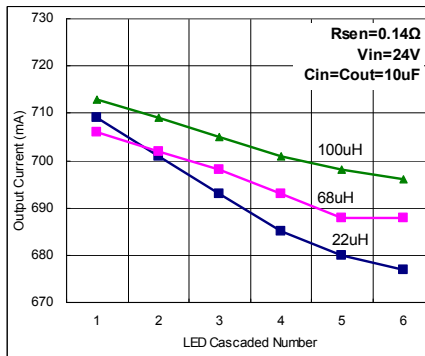

$I_{OUT}=700mA$
Fig. 53

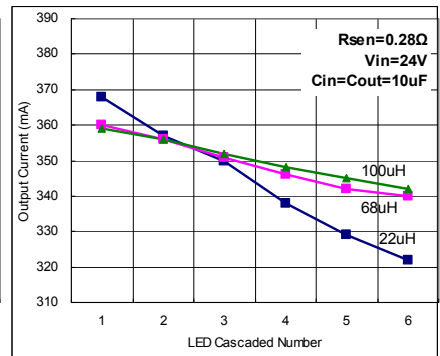

$I_{OUT}=350mA$
Fig. 54

Output current vs. LED cascaded number @ $V_{IN}=36V$

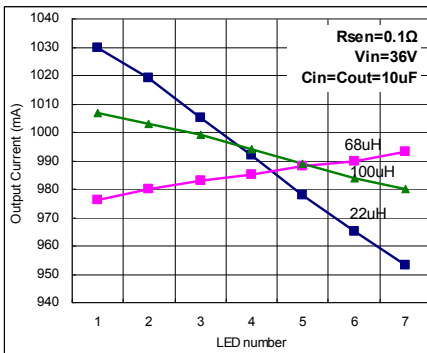

$I_{OUT}=1A$
Fig. 55

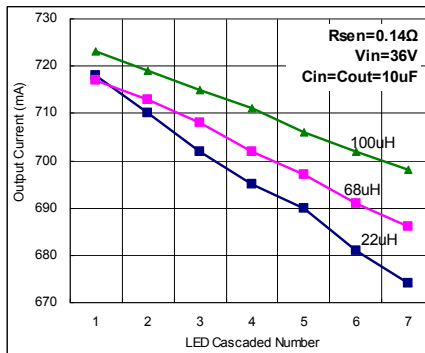

$I_{OUT}=700mA$
Fig. 56

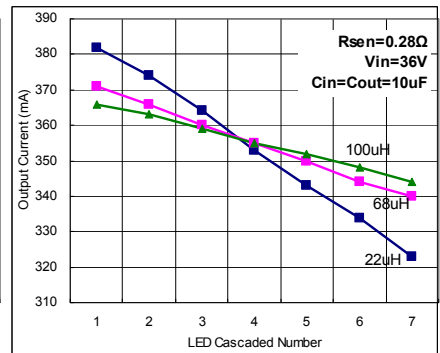

$I_{OUT}=350mA$
Fig. 57

MBI6655

Step-Down, 1A LED Driver

7. Switching Frequency vs. LED Cascaded Number at Various Inductor

Output current vs. LED cascaded number @ $V_{IN}=12V$

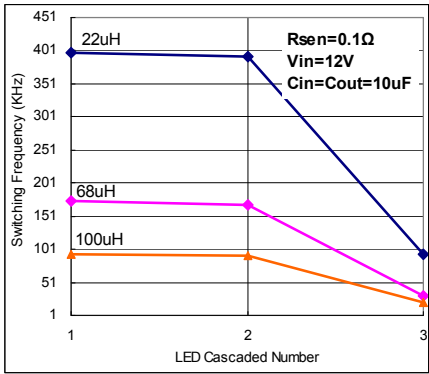

$I_{OUT}=1A$
Fig. 58

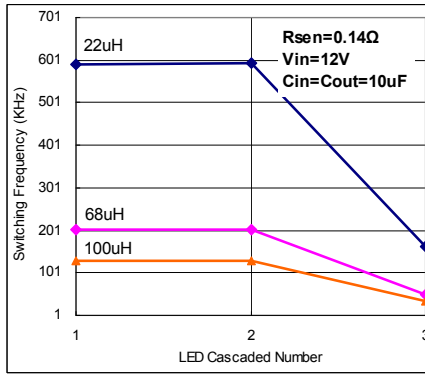

$I_{OUT}=700mA$
Fig. 59

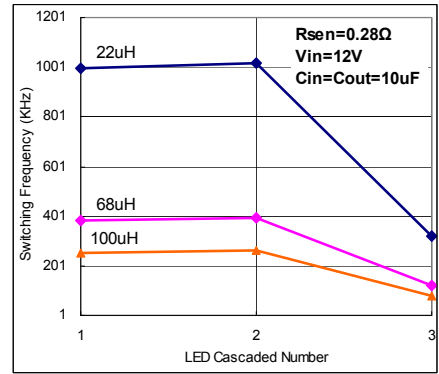

$I_{OUT}=350mA$
Fig. 60

Output current vs. LED cascaded number @ $V_{IN}=24V$

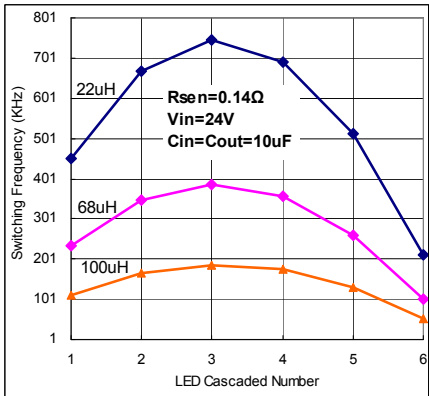

$I_{OUT}=1A$
Fig. 61

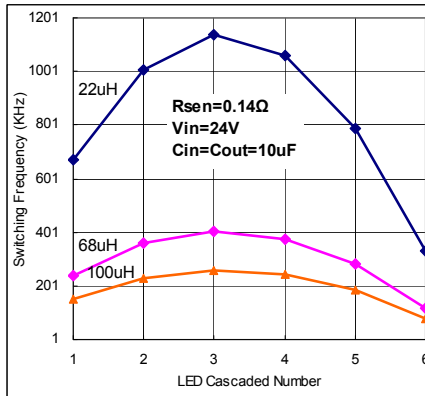

$I_{OUT}=700mA$
Fig. 62

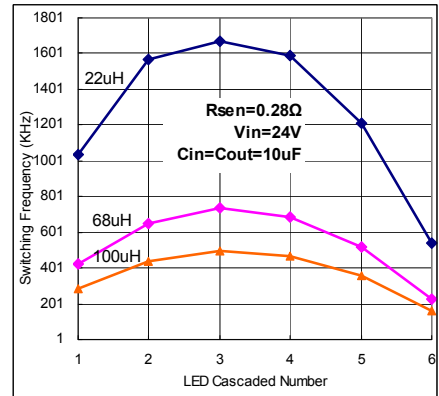

$I_{OUT}=350mA$
Fig. 63

Output current vs. LED cascaded number @ $V_{IN}=36V$

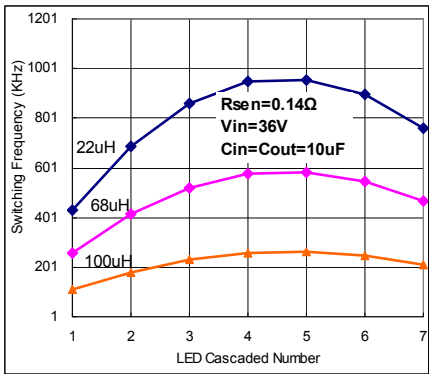

$I_{OUT}=1A$
Fig. 64

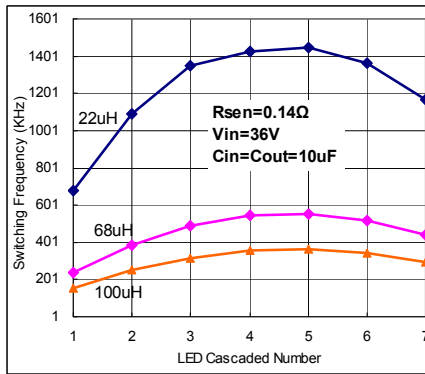

$I_{OUT}=700mA$
Fig. 65

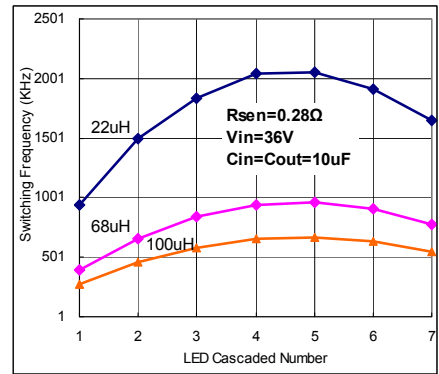

$I_{OUT}=350mA$
Fig. 66

Application Information

The MBI6655 is a simple and high efficient buck converter with capability to drive up to 1A of loading. The MBI6655 adopts hysteretic PFM control scheme to regulate loading and input voltage variations. The hysteretic PFM control requires no loop compensation bringing very fast load transient response and achieving excellent efficiency at light loading.

Setting Output Current

The output current (I_{OUT}) is set by an external resistor, R_{SEN} . The relationship between I_{OUT} and R_{SEN} is as below:

$$V_{SEN}=0.1V;$$

$$R_{SEN}=(V_{SEN}/I_{OUT})=(0.1V/I_{OUT});$$

$$I_{OUT}=(V_{SEN}/R_{SEN})=(0.1V/R_{SEN})$$

where R_{SEN} is the resistance of the external resistor connecting to SEN terminal and V_{SEN} is the voltage of external resistor. The magnitude of current (as a function of R_{SEN}) is around 1000mA at 0.1Ω.

Minimum Input Voltage and Start-Up Protection

The minimum input voltage is the sum of the voltage drops on R_{SEN} , R_S , DCR of L1, $R_{ds(on)}$ of internal MOSFET and the total forward voltage of LEDs. The dynamic resistance of LED, R_s , is the inverse of the slope in linear forward voltage model for LED. This electrical characteristic can be provided by LED manufacturers. The equivalent impedance of the MBI6655 application circuit is shown in Fig.67. As the input voltage is smaller than minimum input voltage such as start-up condition, the output current will be larger than the preset output current. Thus, under this circumstance, the output current is limited to 1.15 times of preset one as shown in Fig.68.

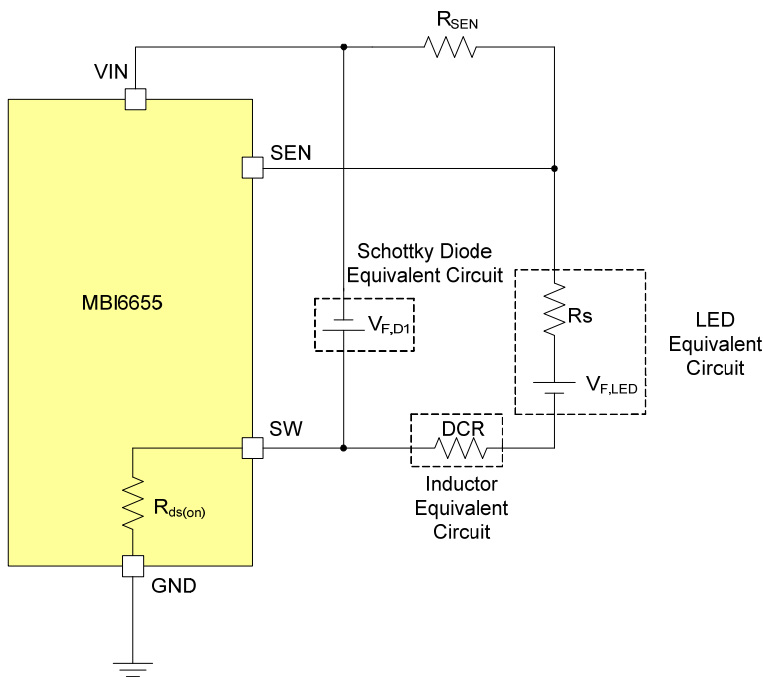

Fig. 67 The equivalent impedance in a MBI6655 application circuit

MBI6655

Step-Down, 1A LED Driver

PWM Dimming

The dimming of LEDs can be performed by applying PWM signals to DIM pin. A logic low (below 0.5V) at DIM will disable the internal MOSFET and shut off the current flow to the LED array. An internal pull-up circuit ensures that the MBI6655 is ON when DIM pin is unconnected. Therefore, the need for an external pull-up resistor will be eliminated. The following Fig. 69 and 70 show good linearity in dimming application of MBI6655.

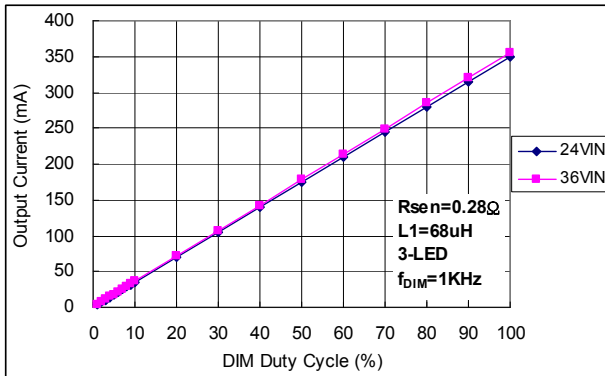

Fig. 69 DIM duty cycle: 1% ~ 100%

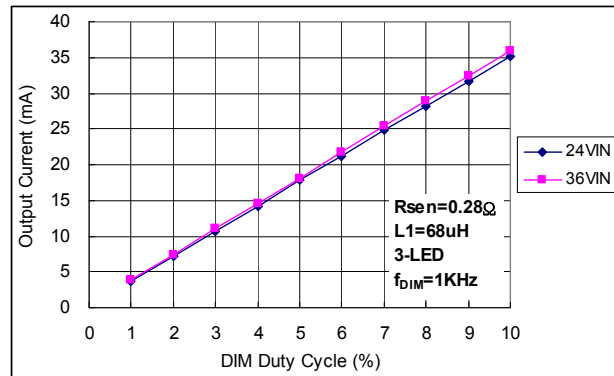
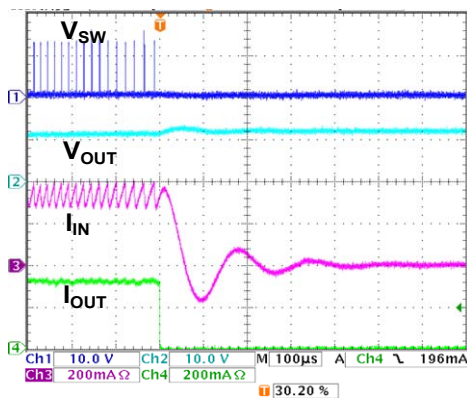

Fig. 70 DIM duty cycle: 1% ~ 10%

LED Open-Circuit Protection

When any LED connecting to the MBI6655 is open-circuited, the output current of MBI6655 will be turned off. The waveform is shown in Fig. 71.



LED Short-Circuit Protection

When any LED connecting to the MBI6655 is short-circuited, the output current of MBI6655 will still be limited to its preset value as shown in Fig. 72.

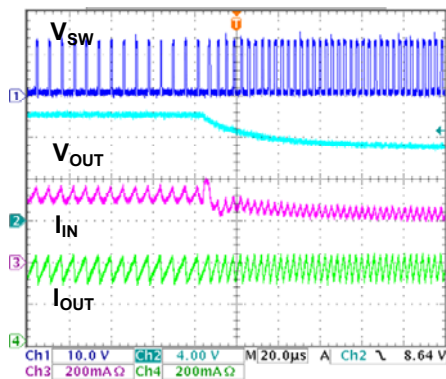

Fig. 72 Short-circuited protection

MBI6655**Step-Down, 1A LED Driver****TP Function (Thermal Protection)**

When the junction temperature exceeds the threshold, T_x (165°C), TP function turns off the output current. The waveform can refer to Fig. 73. The SW stops switching and the output current will be turned off. Thus, the junction temperature starts to decrease. As soon as the temperature is below 135°C, the output current will be turned on again. The switching of on-state and off-state are at a high frequency; thus, the blinking is imperceptible. The average output current is limited, and therefore, the driver is protected from being overheated.

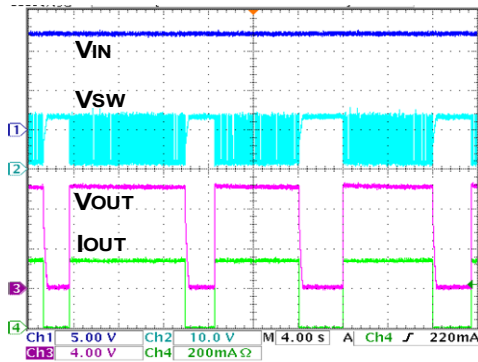

Fig. 73 Thermal protection

Over Current Protection

MBI6655 offers over current protection to against destructive damage which results from abnormal excessive current flowing through. The function is activated, when the LED current reaches the threshold which is approximately 1.8A. Then, the integrated power switch of MBI6655 will be turned off. When the function is activated, it will not be removed until the power reset action is taken.

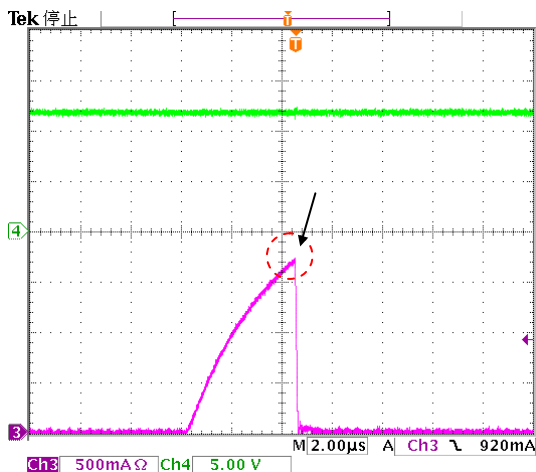

Fig. 74 Over current protection

MBI6655

Step-Down, 1A LED Driver

Design Consideration

Switching Frequency

To achieve better output current accuracy, the switching frequency should be determined by minimum on/off time of SW waveform. For example, if the duty cycle of MBI6655 is larger than 0.5, then the switching frequency should be determined by the minimum off time, and vice versa. Thus the switching frequency of MBI6655 is:

$$f_{SW} = \frac{1}{T_S} = \frac{1}{\frac{T_{OFF, min}}{(1-D)}}, \text{ when the duty cycle is larger than 0.5} \quad (1)$$

$$\text{or } f_{SW} = \frac{1}{T_S} = \frac{1}{\frac{T_{ON, min}}{D}}, \text{ when the duty cycle is smaller than 0.5.} \quad (2)$$

The switching frequency is related to efficiency (better at low frequency), the size/cost of components (smaller/cheaper at high frequency), and the amplitude of output ripple voltage and current (smaller at high frequency). The slower switching frequency comes from the large value of inductor. In many applications, the sensitivity of EMI limits the switching frequency of MBI6655. The switching frequency can be ranged from 40KHz to 1.0MHz.

LED Ripple Current

An LED constant current driver, such as MBI6655, is designed to control the current through the cascaded LED, instead of the voltage across it. Higher LED ripple current allows the use of smaller inductance, smaller output capacitance and even without an output capacitor. The advantages of higher LED ripple current are to minimize PCB size and reduce cost because of no output capacitor. Lower LED ripple current requires larger inductance, and output capacitor. The advantages of lower LED ripple current are to extend LED life time and to reduce heating of LED. The recommended ripple current is from 5% to 20% of normal LED current.

Component Selection

Inductor Selection

The inductance is determined by two factors: the switching frequency and the inductor ripple current. The calculation of the inductance, L1, can be described as

$$L1 > (V_{IN} - V_{OUT} - V_{SEN} - (R_{ds(on)} \times I_{OUT})) \times \frac{D}{f_{SW} \times \Delta I_L}$$

where

$R_{ds(on)}$ is the on-resistance of internal MOSFET of the MBI6655. The typical is 0.3Ω at $12V_{IN}$.

D is the duty cycle of the MBI6655, $D = V_{OUT}/V_{IN}$.

f_{SW} is the switching frequency of the MBI6655.

ΔI_L is the ripple current of inductor, $\Delta I_L = (1.15 \times I_{OUT}) - (0.85 \times I_{OUT}) = 0.3 \times I_{OUT}$.

When selecting an inductor, not only the inductance but also the saturation current that should be considered as the factors to affect the performance of module. In general, it is recommended to choose an inductor with 1.5 times of LED current as the saturation current. Also, the larger inductance gains the better line/load regulation. However, the inductance and saturation current become a trade-off at the same inductor size. An inductor with shield is recommended to reduce the EMI interference. However, this is another trade-off with heat dissipation.

MBI6655

Step-Down, 1A LED Driver

Schottky Diode Selection

The MBI6655 needs a flywheel diode, D1, to carry the inductor current when the MOSFET is off. The recommended flywheel diode is schottky diode with low forward voltage for better efficiency. Two factors determine the selection of schottky diode. One is the maximum reverse voltage. The recommended rated voltage of the reverse voltage is at least 1.5 times of input voltage. The other is the maximum forward current, which works when the MOSFET is off. And the recommended forward current is 1.5 times of output current. Users should carefully choose an appropriate schottky diode which can perform low leakage current at high temperature.

Input Capacitor Selection

The input capacitor, C_{IN} , can supply pulses of current for MBI6655 when the MOSFET is on. And C_{IN} is charged by the input voltage when the MOSFET is off. As the input voltage is lower than minimum input voltage, the internal MOSFET of MBI6655 remains constantly on, and the LED current is limited not to exceed 1.15 times of normal current. Under the circumstance, the selection of the capacitor is more important since higher current has to be handled. For achieving stable lighting system, it is recommended that to select $C_{IN} = 10\mu\text{F}$ capacitor and maximum rating 1.5 times to input voltage which you applied to

Electrolytic capacitor or ceramic capacitor is both recommended to be input capacitor. The advantages of electrolytic capacitor are wider capacitance selection and high availability. However, the lifetime is a concern, especially under high temperature condition. The other reliable option is ceramic capacitor. The advantages of ceramic capacitor are high frequency characteristic, small size, low ESR and low cost. However, due to natural of low ESR characteristic itself, voltage overshoot is easily generated from hot-plug to power. Thus, it is suggested to place TVS (Transient Voltage Suppressor) parallel to C_{IN} , when hot-plug to power is expected.

For better power integrity, it is suggest that to place a $C_{BP} = 0.1-1\mu\text{F}$ ceramic capacitor parallel input capacitor and position as close to VIN pin as possible.

Output Capacitor Selection (Optional)

A capacitor paralleled with cascaded LED can reduce the LED ripple current and allow smaller inductance.

MBI6655

Step-Down, 1A LED Driver

PCB Layout Consideration

To enhance the efficiency and stabilize the system, careful considerations of PCB layout is important. There are several factors should be considered.

1. A complete ground area is helpful to eliminate the switching noise.
2. Keep the IC's GND pin and the ground leads of input and output filter capacitors less than 5mm.
3. To maximize output power efficiency and minimize output ripple voltage, use a ground plane and solder the IC's GND pin directly to the ground plane.
4. To stabilize the system, the heat sink of the MBI6655 is recommended to connect to ground plane directly.
5. Enhance the heat dissipation, the area of ground plane, which IC's heat sink is soldered on, should be as large as possible.
6. The components placement should follow the sequence of the input capacitor, the input filter capacitor, R_{SEN} and V_{IN} pin. The components layout path should not be spread out. In other words, the components should be placed on the same path.
7. The input capacitor should be placed to IC's V_{IN} pin as close as possible.
8. To avoid the parasitic effect of trace, the R_{SEN} should be placed to IC's V_{IN} and SEN pins as close as possible.
9. The area, which is composed of IC's SW pin, schottky diode and inductor, should be wide and short.
10. The path, which flows large current, should be wide and short to eliminate the parasite element.
11. When SW is ON/OFF, the direction of power loop should keep the same way to enhance the efficiency. The sketch is shown as Figure11.
12. To avoid the unexpected damage of malfunction to the driver board, users should pay attention to the quality of soldering in the PCB by checking if cold welding or cold joint happens between the pins of IC and the PCB.
13. To stabilize the system, do not put the inductor right under the IC.

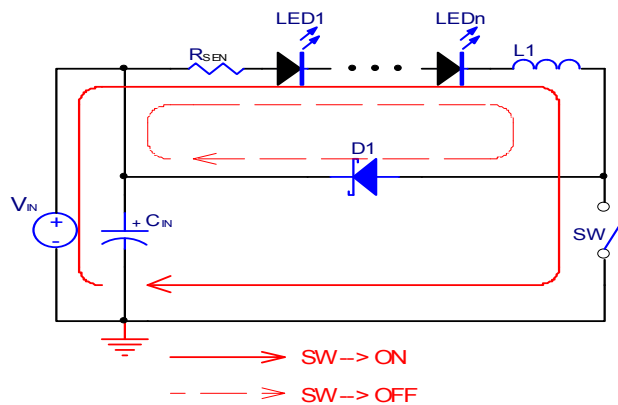

Fig. 75 Power loop of MBI6655

PCB Layout

Fig. 76 is the recommended layout diagram of the MBI6655GSB package.

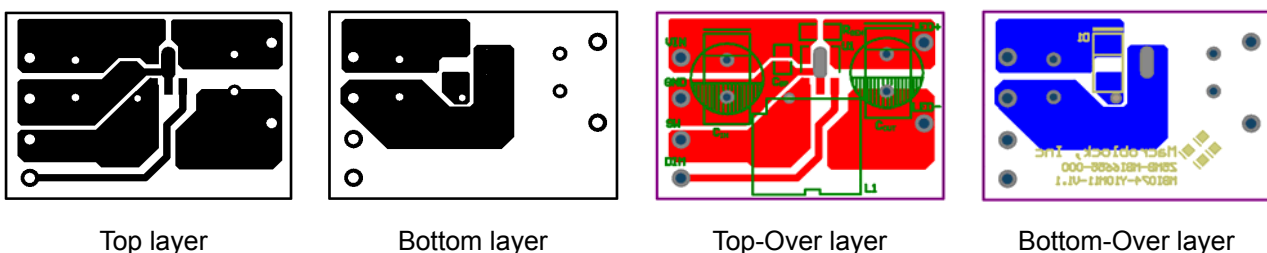

Fig. 76 The layout diagram of the MBI6655GSB

MBI6655

Step-Down, 1A LED Driver

Package Power Dissipation (PD)

The maximum power dissipation, $P_D(max)=(T_j-T_a)/R_{th(j-a)}$, decreases as the ambient temperature increases.

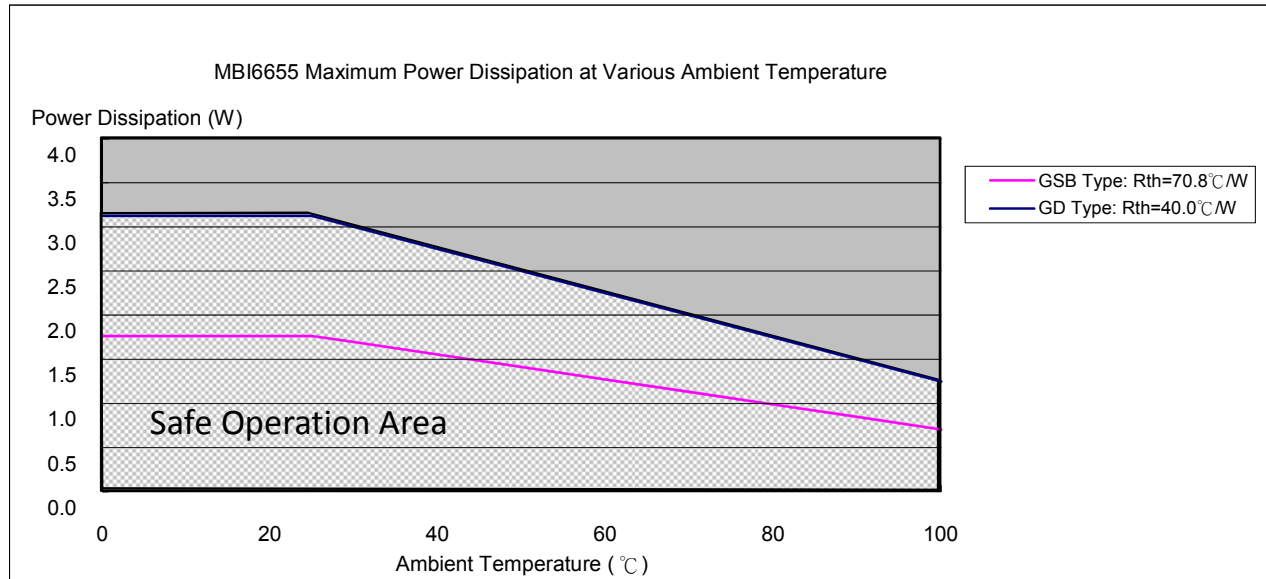

MBI6655

Step-Down, 1A LED Driver

Soldering Process of "Pb-free & Green" Package Plating*

Macroblock has defined "Pb-Free & Green" to mean semiconductor products that are compatible with the current RoHS requirements and selected 100% pure tin (Sn) to provide forward and backward compatibility with both the current industry-standard SnPb-based soldering processes and higher-temperature Pb-free processes. Pure tin is widely accepted by customers and suppliers of electronic devices in Europe, Asia and the US as the lead-free surface finish of choice to replace tin-lead. Also, it adopts tin/lead (SnPb) solder paste, and please refer to the JEDEC J-STD-020C for the temperature of solder bath. However, in the whole Pb-free soldering processes and materials, 100% pure tin (Sn) will all require from 245 °C to 260 °C for proper soldering on boards, referring to JEDEC J-STD-020C as shown below.

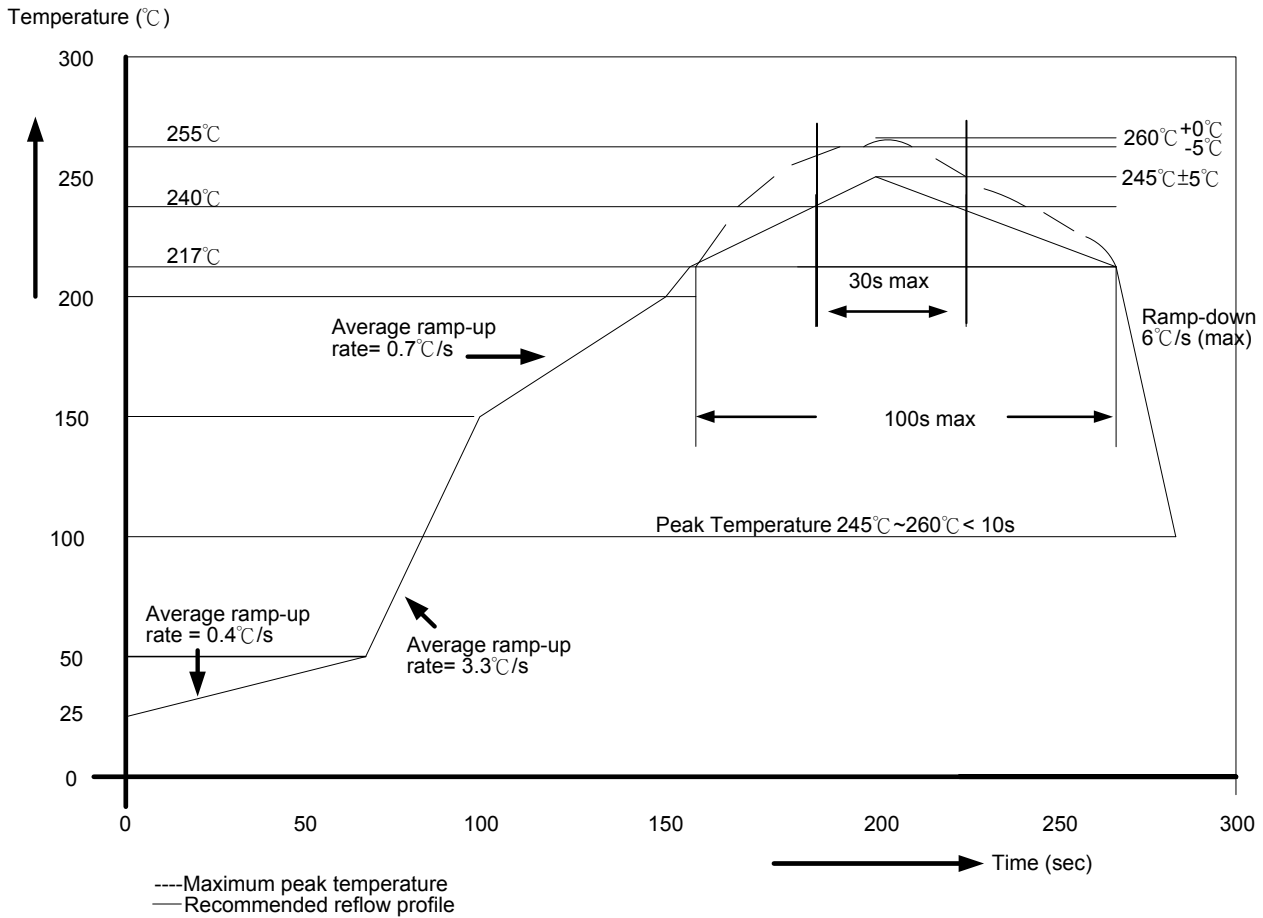

Package Thickness	Volume mm ³ <350	Volume mm ³ 350-2000	Volume mm ³ ≥ 2000
<1.6mm	260 +0 °C	260 +0 °C	260 +0 °C
1.6mm – 2.5mm	260 +0 °C	250 +0 °C	245 +0 °C
≥ 2.5mm	250 +0 °C	245 +0 °C	245 +0 °C

*Note: For details, please refer to Macroblock's "Policy on Pb-free & Green Package".

MBI6655

Step-Down, 1A LED Driver

Outline Drawing

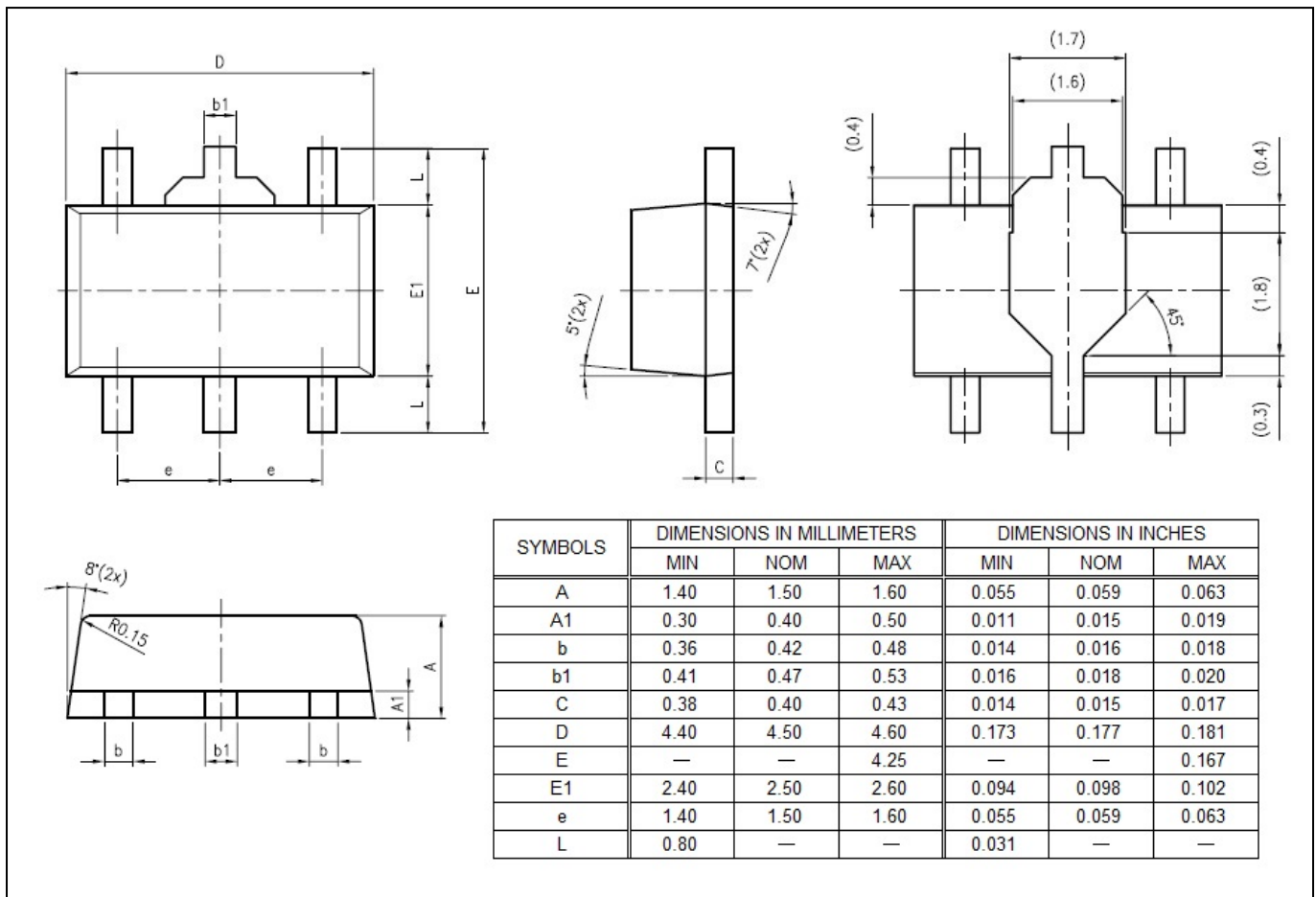

MBI6655GSB Outline Drawing

Note: Please use the maximum dimensions for the thermal pad layout. To avoid the short circuit risk, the vias or circuit traces shall not pass through the maximum area of thermal pad.

MBI6655

Step-Down, 1A LED Driver

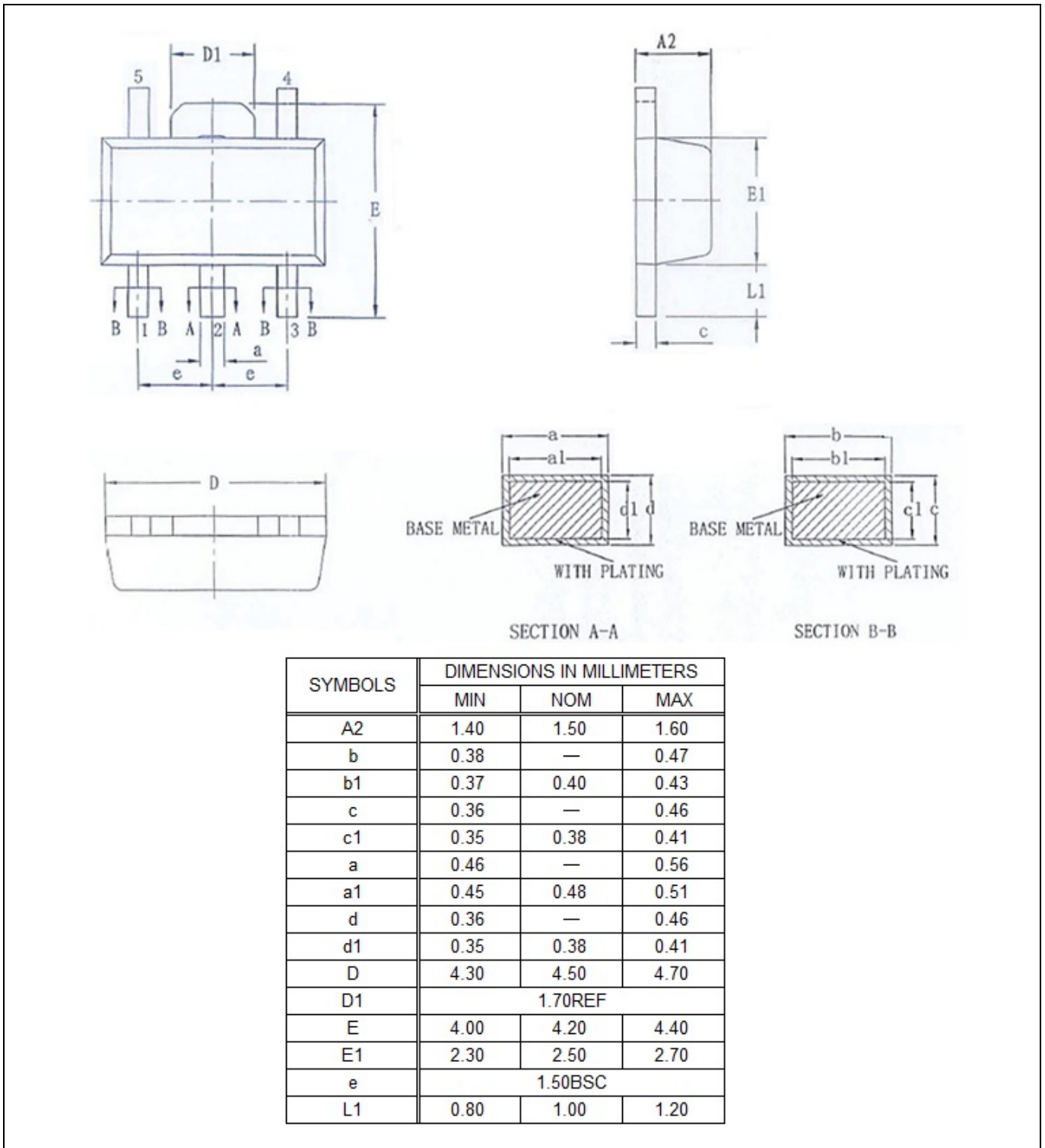

MBI6655GSB Outline Drawing

Note: Please use the maximum dimensions for the thermal pad layout. To avoid the short circuit risk, the vias or circuit traces shall not pass through the maximum area of thermal pad.

MBI6655

Step-Down, 1A LED Driver

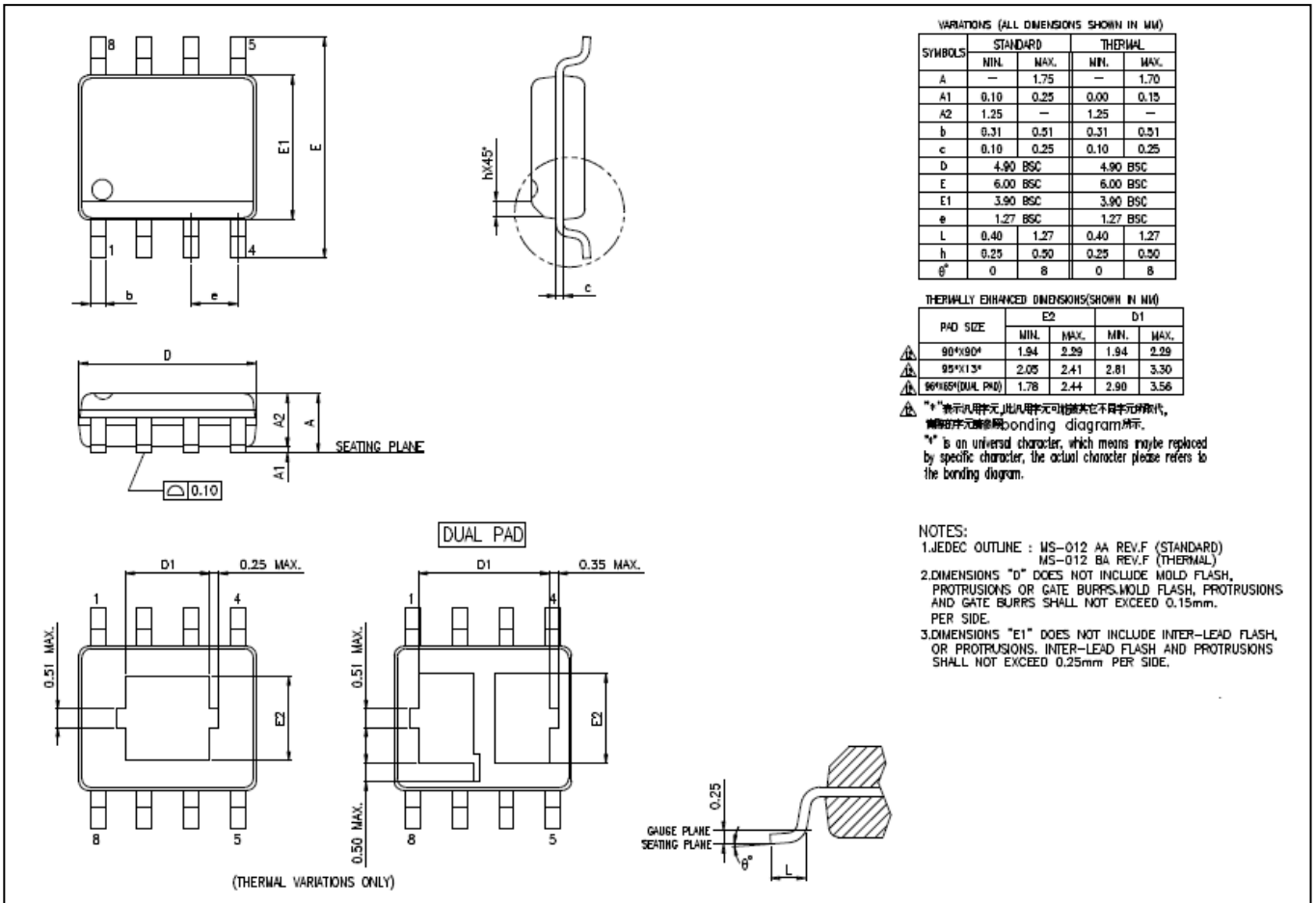

MBI6655GD Outline Drawing

Note: Please use the maximum dimensions for the thermal pad layout. To avoid the short circuit risk, the vias or circuit traces shall not pass through the maximum area of thermal pad.

MBI6655

Step-Down, 1A LED Driver

Product Top Mark Information

GSB (SOT-89)/GD (SOP8L)

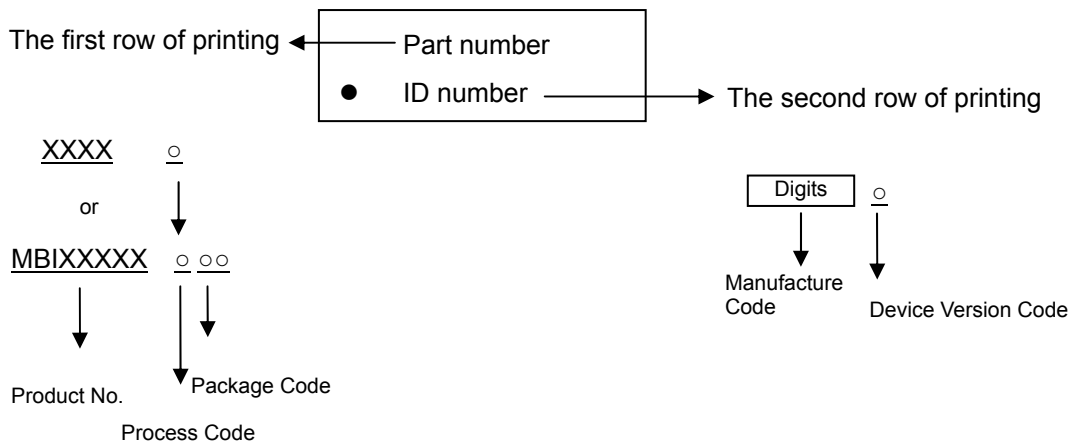

Product Revision History

Datasheet version	Device Version Code
V1.00	A
V1.01	A
V1.02	A
V1.03	A

Product Ordering Information

Part Number	RoHS Compliant Package Type	Weight (g)
MBI6655GSB-A	SOT-89-5L	0.016g
MBI6655GD-A	SOP8L-150-1.27	0.079g

*Please place your order with the “product ordering number” information on your purchase order (PO).

Disclaimer

Macroblock reserves the right to make changes, corrections, modifications, and improvements to their products and documents or discontinue any product or service. Customers are advised to consult their sales representative for the latest product information before ordering. All products are sold subject to the terms and conditions supplied at the time of order acknowledgement, including those pertaining to warranty, patent infringement, and limitation of liability.

Macroblock's products are not designed to be used as components in device intended to support or sustain life or in military applications. Use of Macroblock's products in components intended for surgical implant into the body, or other applications in which failure of Macroblock's products could create a situation where personal death or injury may occur, is not authorized without the express written approval of the Managing Director of Macroblock.

Macroblock will not be held liable for any damages or claims resulting from the use of its products in medical and military applications.

All text, images, logos and information contained on this document is the intellectual property of Macroblock.

Unauthorized reproduction, duplication, extraction, use or disclosure of the above mentioned intellectual property will be deemed as infringement.