



## ■ Features

- Universal AC input / Full range
- Built-in active PFC function, PF>0.95
- 250% peak power capability
- High efficiency up to 89%
- Withstand 300VAC surge input for 5 seconds
- Protections: Short circuit / Overload / Over voltage / Over temperature
- 1U low profile 41mm
- Built-in cooling fan ON-OFF control
- Built-in DC OK signal
- Built-in remote sense function
- 5 years warranty

## ■ Applications

- Industrial automation machinery
- Industrial control system
- Mechanical and electrical equipment
- Diagnostic or biological facilities
- Test or measurement systems
- Telecommunication equipment

## ■ Description

HRP-300N is a 300W single output type AC/DC power supply. This series operates for 85~264VAC input voltage and offers the models with the DC output mostly demanded from the industry. Each model is cooled by the built-in fan with fan ON-OFF control, working for the temperature up to 70°C. Moreover, HRP-300N provides 250% short-duration peak power for motor applications and electromechanical loads requiring much higher power during start-up.

## ■ Model Encoding

**HRP - 300N - 24**

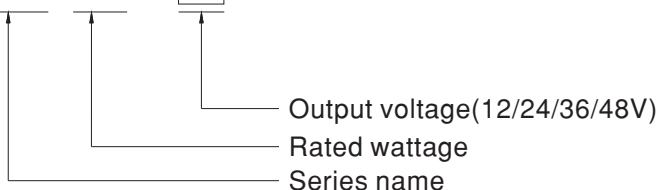



**SPECIFICATION**

MODEL		HRP-300N-12	HRP-300N-24	HRP-300N-36	HRP-300N-48	
OUTPUT	DC VOLTAGE	12V	24V	36V	48V	
	RATED CURRENT	27A	14A	9A	7A	
	CURRENT RANGE	0 ~ 27A	0 ~ 14A	0 ~ 9A	0 ~ 7A	
	RATED POWER	324W	336W	324W	336W	
	RIPPLE & NOISE (max.) Note.2	120mVp-p	150mVp-p	250mVp-p	250mVp-p	
	VOLTAGE ADJ. RANGE	10.2 ~ 13.8V	21.6 ~ 28.8V	28.8 ~ 39.6V	40.8 ~ 55.2V	
	VOLTAGE TOLERANCE Note.3	± 1.0%	± 1.0%	± 1.0%	± 1.0%	
	LINE REGULATION	± 0.3%	± 0.2%	± 0.2%	± 0.2%	
	LOAD REGULATION	± 0.5%	± 0.5%	± 0.5%	± 0.5%	
	SETUP, RISE TIME	1000ms, 50ms/230VAC    2500ms, 50ms/115VAC at full load				
HOLD UP TIME (Typ.)	16ms/230VAC    16ms/115VAC at full load					
INPUT	VOLTAGE RANGE Note.4	85 ~ 264VAC    120 ~ 370VDC				
	FREQUENCY RANGE	47 ~ 63Hz				
	POWER FACTOR (Typ.)	PF>0.95/230VAC    PF>0.99/115VAC at full load				
	EFFICIENCY (Typ.)	88%	87%	88%	89%	
	AC CURRENT (Typ.)	3.5A/115VAC    1.8A/230VAC				
	INRUSH CURRENT (Typ.)	35A/115VAC    75A/230VAC				
	LEAKAGE CURRENT	<1.5mA / 240VAC				
PROTECTION	OVERLOAD	Normally works within 105 ~ 200% rated output power for more than 5 seconds and then shut down o/p voltage, re-power on to recover Constant current limiting for output power >280% rated for more than 5 seconds and then shut down o/p voltage, re-power on to recover				
	OVER VOLTAGE	14.4 ~ 16.8V	30 ~ 34.8V	41.4 ~ 48.6V	57.6 ~ 67.2V	
	OVER TEMPERATURE	Protection type : Shut down o/p voltage, re-power on to recover Shut down o/p voltage, recovers automatically after temperature goes down				
FUNCTION	DC OK SIGNAL	PSU turns on : 3.3 ~ 5.6V ; PSU turns off : 0 ~ 1V				
	FAN CONTROL (Typ.)	Load 35 ± 15% or RTH2 ≥ 50°C Fan on				
ENVIRONMENT	WORKING TEMP.	-40 ~ +70°C (Refer to "Derating Curve")				
	WORKING HUMIDITY	20 ~ 90% RH non-condensing				
	STORAGE TEMP., HUMIDITY	-40 ~ +85°C , 10 ~ 95% RH				
	TEMP. COEFFICIENT	± 0.03%/°C (0 ~ 50°C)				
SAFETY & EMC (Note 5)	VIBRATION	10 ~ 500Hz, 5G 10min./1cycle, 60min. each along X, Y, Z axes				
	SAFETY STANDARDS	UL62368-1, TUV EN62368-1, EAC TP TC 004, AS/NZS 62368.1 approved				
	WITHSTAND VOLTAGE	I/P-O/P:3KVAC    I/P-FG:2KVAC    O/P-FG:0.5KVAC				
	ISOLATION RESISTANCE	I/P-O/P, I/P-FG, O/P-FG:100M Ohms / 500VDC / 25°C / 70% RH				
	EMC EMISSION	Parameter	Standard		Test Level / Note	
		Conducted	EN55032		Class B	
		Radiated	EN55032		Class B	
		Harmonic current	EN61000-3-2		Class A	
		Voltage Flicker	EN61000-3-3		-----	
	EMC IMMUNITY	EN55035 , EN61000-6-2(EN50082-2)				
		Parameter	Standard		Test Level / Note	
		ESD	EN61000-4-2		Level 3, 8KV air; Level 2, 4KV contact	
		RF field	EN61000-4-3		Level 3, 10V/m	
EFT/ Burst		EN61000-4-4		Level 3, 2KV		
Surge		EN61000-4-5		Level 4, 4KV/Line-FG; 2KV/Line-Line		
Conducted		EN61000-4-6		Level 3, 10V		
Magnetic Field		EN61000-4-8		Level 4, 30A/m		
Voltage Dips and Interruptions	EN61000-4-11		95% dip 0.5 periods, 30% dip 25 periods, 95% interruptions 250 periods			
OTHERS	MTBF	529.1K hrs min.    Telcordia TR/SR-332 (Bellcore);    201.43K hrs min.    MIL-HDBK-217F (25°C)				
	DIMENSION	199*105*41mm (L*W*H)				
	PACKING	0.9Kg;15pcs/14.5Kg/0.84CUFT				
NOTE	<p>1. All parameters NOT specially mentioned are measured at 230VAC input, rated load and 25°C of ambient temperature.</p> <p>2. Ripple &amp; noise are measured at 20MHz of bandwidth by using a 12" twisted pair-wire terminated with a 0.1uf &amp; 47uf parallel capacitor.</p> <p>3. Tolerance : includes set up tolerance, line regulation and load regulation.</p> <p>4. Derating may be needed under low input voltages. Please check the derating curve for more details.</p> <p>5. The power supply is considered a component which will be installed into a final equipment. All the EMC tests are been executed by mounting the unit on a 360mm*360mm metal plate with 1mm of thickness. The final equipment must be re-confirmed that it still meets EMC directives. For guidance on how to perform these EMC tests, please refer to "EMI testing of component power supplies." (as available on <a href="http://www.meanwell.com">http://www.meanwell.com</a>)</p> <p>6. The ambient temperature derating of 3.5°C/1000m with fanless models and of 5°C/1000m with fan models for operating altitude higher than 2000m(6500ft).</p> <p>※ Product Liability Disclaimer : For detailed information, please refer to <a href="https://www.meanwell.com/serviceDisclaimer.aspx">https://www.meanwell.com/serviceDisclaimer.aspx</a></p>					

## Block Diagram

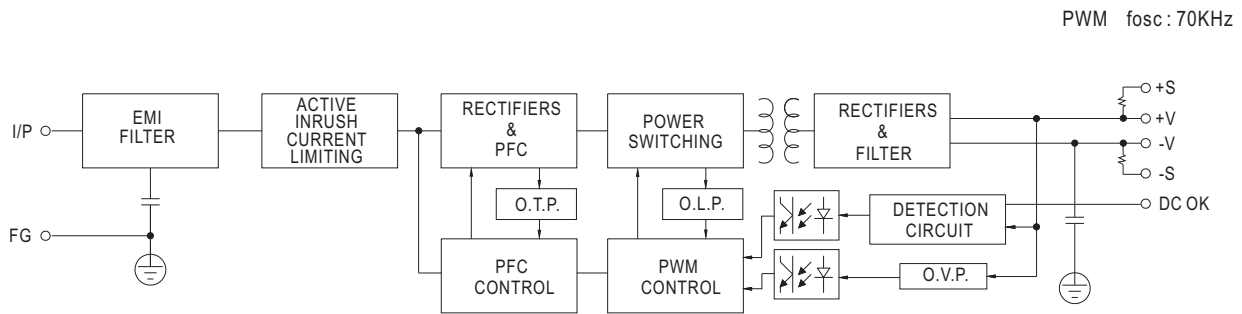

## Derating Curve

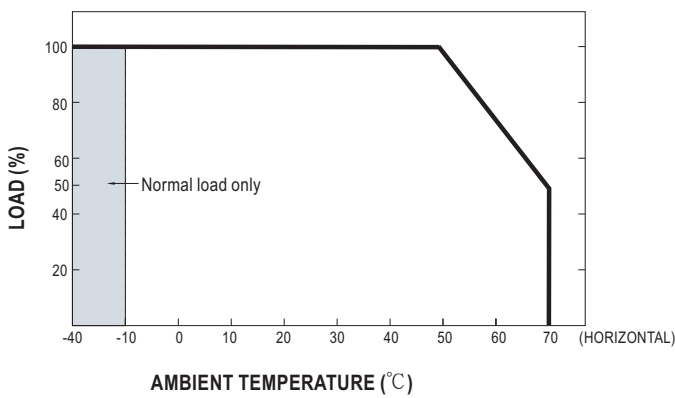

## Output Derating VS Input Voltage

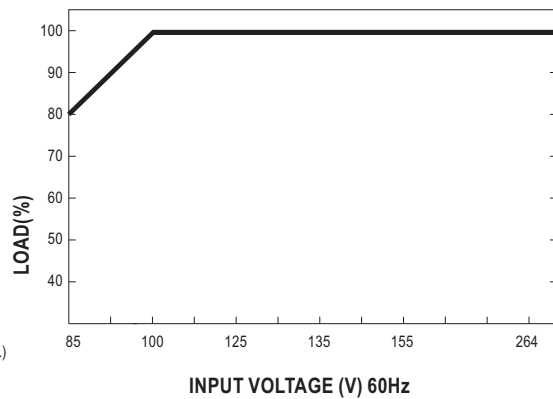

## Function Manual

### 1. Remote Sense

The remote sensing compensates voltage drop on the load wiring up to 0.5V.

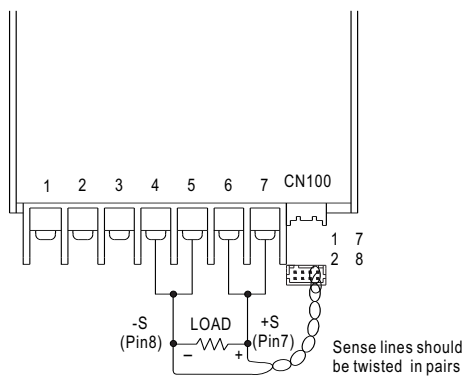

Pin	1	2	7	8
1	NC	DC-OK	GND	+S
2	NC	NC	NC	-S

Fig 1.1

## 2.DC-OK Signal

DC-OK signal is a TTL level signal. High when PSU turns on.

Between DC-OK(pin3) and GND(pin5)	Output Status
3.3 ~ 5.6V	ON
0 ~ 1V	OFF

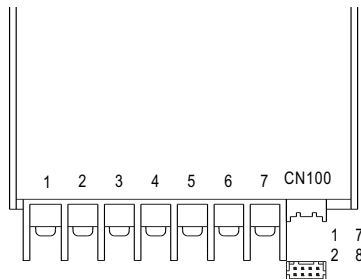

CN100					
1	NC	DC-OK	GND	+S	7
2	NC	NC	NC	-S	8

Fig 2.1

## 3.Peak Power

$$P_{av} = \frac{P_{pk} \times t + P_{npk} \times (T-t)}{T} \leq P_{rated}$$

$$\text{Duty} \frac{t}{T} \times 100\% \leq 35\%$$

$$t \leq 5 \text{ sec}$$

$P_{av}$  : Average output power (W)

$P_{pk}$  : Peak output power (W)

$P_{npk}$  : Non-peak output power (W)

$P_{rated}$  : Rated output power (W)

$t$  : Peak power width (sec)

$T$  : Period (sec)

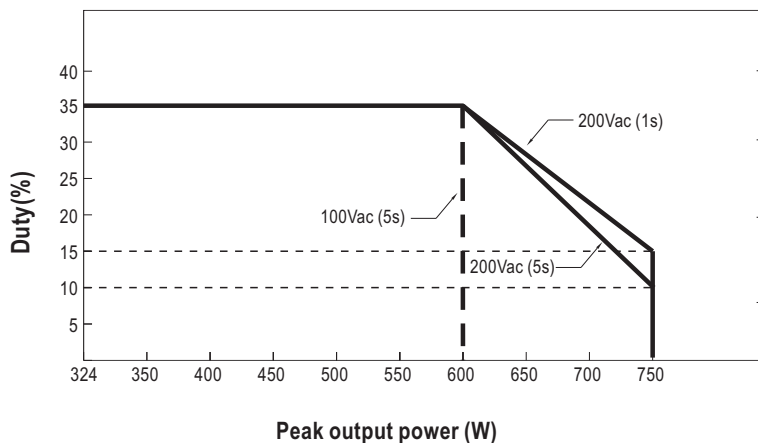
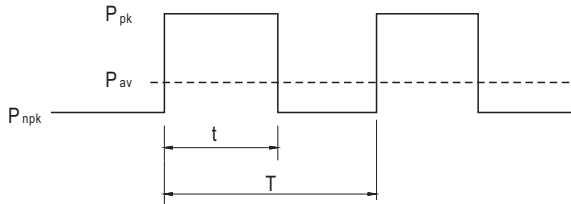

### For example (12V model) :

$V_{in} = 100V$      $\text{Duty}_{max} = 35\%$

$P_{av} = P_{rated} = 324W$

$P_{pk} = 600W$

$t \leq 5 \text{ sec}$

$T \geq 14.29 \text{ sec}$

$$P_{av} = \frac{P_{pk} \times t + P_{npk} \times (T-t)}{T} = \frac{600 \times 5 + P_{npk} \times (14.29 - 5)}{14.29} \leq 324W$$

$$P_{npk} \leq 175.4W$$

**Mechanical Specification**

Case No.980A Unit:mm

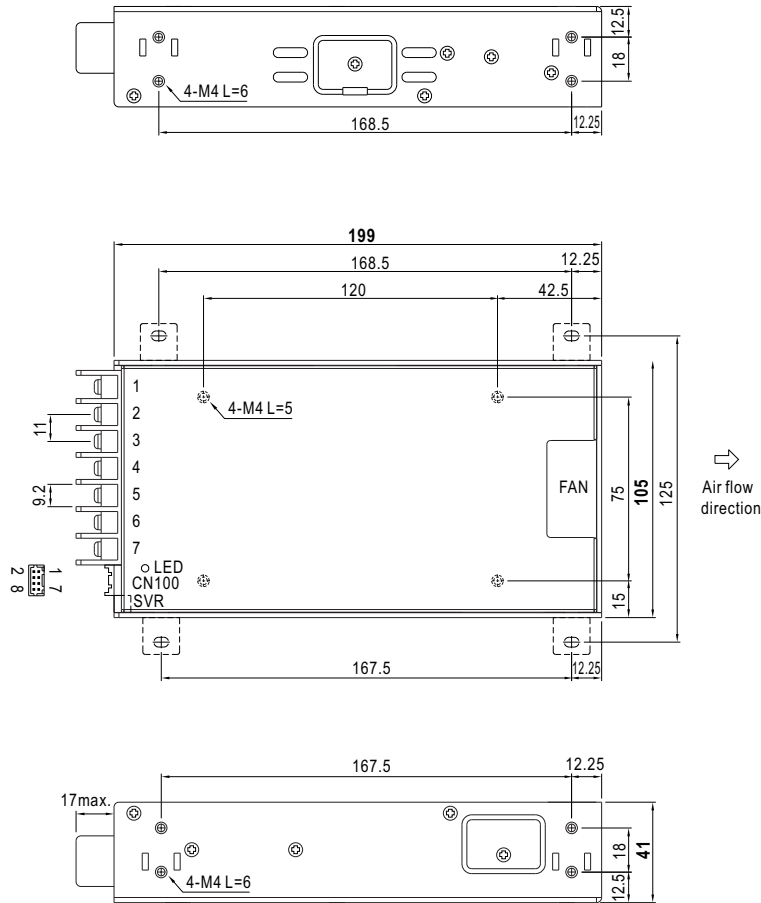

**Terminal Pin No. Assignment**

Pin No.	Assignment	Pin No.	Assignment
1	AC/L	4,5	DC OUTPUT -V
2	AC/N	6,7	DC OUTPUT +V
3	FG $\perp$		

**Connector Pin No. Assignment (CN100) :**  
HRS DF11-08DP-2DS or equivalent

Pin No.	Assignment	Mating Housing	Terminal
1,2,4,6	NC	HRS DF11-8DS or equivalent	HRS DF11-**SC or equivalent
3	DC-OK		
5	GND		
7	+S		
8	-S		

**Installation Manual**

Please refer to : <http://www.meanwell.com/manual.html>