

**General Description:**

The IRF7204TR is the single P-Channel logic enhancement mode power field effect transistors to provide excellent  $R_{DS(on)}$ , low gate charge and low gate resistance. It's up to -30V operation voltage is well suited in switching mode power supply, SMPS, notebook computer power management and other battery powered circuits.

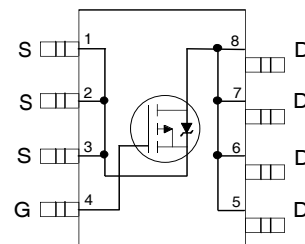

Top View

**Features:**

- $R_{DS(ON)} < 55m @ V_{GS} = 10V$
- $R_{DS(ON)} < 90m @ V_{GS} = 4.5V$
- Super high density cell design for extremely low
- $R_{DS(ON)}$  Exceptional on-resistance and maximum DC current

**Applications:**

- Switching power supply, SMPS
- Battery Powered System
- DC/DC Converter
- DC/AC Converter
- Load Switch

**Absolute Maximum Ratings ( $T_A = 25^\circ C$  unless otherwise noted)**

Parameter	Symbol	Limit	Unit
Drain-Source Voltage	$V_{DS}$	-30	V
Gate-Source Voltage	$V_{GS}$	$\pm 20$	V
Drain Current-Continuous	$I_D$	-5.1	A
Drain Current-Pulsed (Note 1)	$I_{DM}$	-20	A
Maximum Power Dissipation	$P_D$	2.5	W
Operating Junction and Storage Temperature Range	$T_J, T_{STG}$	-55 To 150	$^\circ C$

**Thermal Characteristic**

Thermal Resistance, Junction-to-Ambient (Note 2)	$R_{\theta JA}$	50	$^\circ C/W$
--	-----------------	----	--------------

**Electrical Characteristics (T<sub>A</sub>=25°C unless otherwise noted)**

Parameter	Symbol	Condition	Min	Typ	Max	Unit
<b>Off Characteristics</b>						
Drain-Source Breakdown Voltage	BV <sub>DSS</sub>	V <sub>GS</sub> =0V I <sub>D</sub> =-250μA	-30	-33	-	V
Zero Gate Voltage Drain Current	I <sub>DSS</sub>	V <sub>DS</sub> =-24V, V <sub>GS</sub> =0V	-	-	-1	μA
Gate-Body Leakage Current	I <sub>GSS</sub>	V <sub>GS</sub> =±20V, V <sub>DS</sub> =0V	-	-	±100	nA
<b>On Characteristics (Note 3)</b>						
Gate Threshold Voltage	V <sub>GS(th)</sub>	V <sub>DS</sub> =V <sub>GS</sub> , I <sub>D</sub> =-250μA	-0.8	-1.2	-2.0	V
Drain-Source On-State Resistance	R <sub>DS(ON)</sub>	V <sub>GS</sub> =-10V, I <sub>D</sub> =-5.1A	-	43	55	mΩ
		V <sub>GS</sub> =-4.5V, I <sub>D</sub> =-4.2A	-	62	90	mΩ
Forward Transconductance	g <sub>FS</sub>	V <sub>DS</sub> =-15V, I <sub>D</sub> =-4.5A	4	7	-	S
<b>Dynamic Characteristics (Note 4)</b>						
Input Capacitance	C <sub>iss</sub>	V <sub>DS</sub> =-15V, V <sub>GS</sub> =0V, F=1.0MHz	-	520	-	PF
Output Capacitance	C <sub>oss</sub>		-	130	-	PF
Reverse Transfer Capacitance	C <sub>rss</sub>		-	70	-	PF
<b>Switching Characteristics (Note 4)</b>						
Turn-on Delay Time	t <sub>d(on)</sub>	V <sub>DD</sub> =-15V, I <sub>D</sub> =-1A, V <sub>GS</sub> =-10V, R <sub>GEN</sub> =6Ω	-	7	-	nS
Turn-on Rise Time	t <sub>r</sub>		-	13	-	nS
Turn-Off Delay Time	t <sub>d(off)</sub>		-	14	-	nS
Turn-Off Fall Time	t <sub>f</sub>		-	9	-	nS
Total Gate Charge	Q <sub>g</sub>	V <sub>DS</sub> =-15V, I <sub>D</sub> =-5.1A, V <sub>GS</sub> =-10V	-	11	-	nC
Gate-Source Charge	Q <sub>gs</sub>		-	2.2	-	nC
Gate-Drain Charge	Q <sub>gd</sub>		-	3	-	nC
<b>Drain-Source Diode Characteristics</b>						
Diode Forward Voltage (Note 3)	V <sub>SD</sub>	V <sub>GS</sub> =0V, I <sub>S</sub> =-5.1A	-	-	-1.2	V

Typical Electrical and Thermal Characteristics

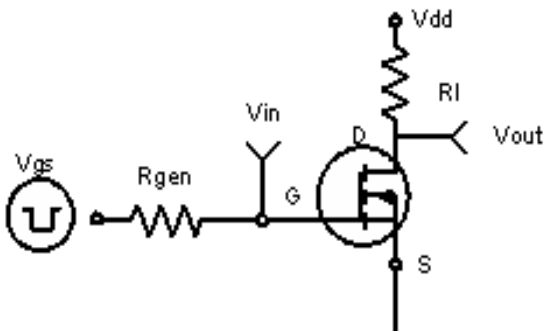

Figure 1: Switching Test Circuit

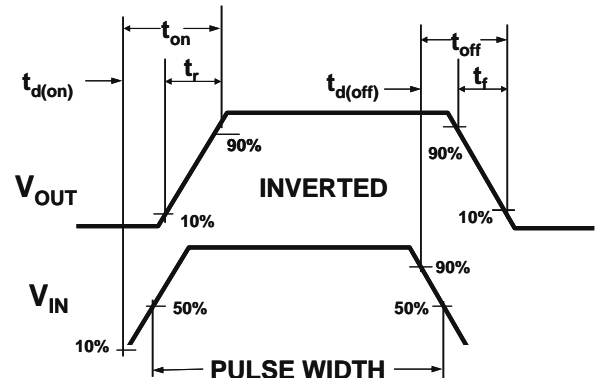
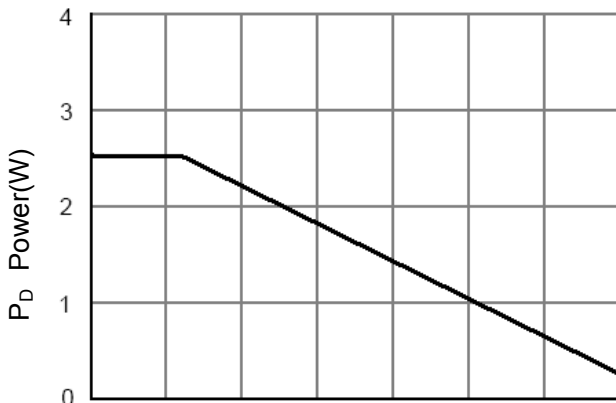
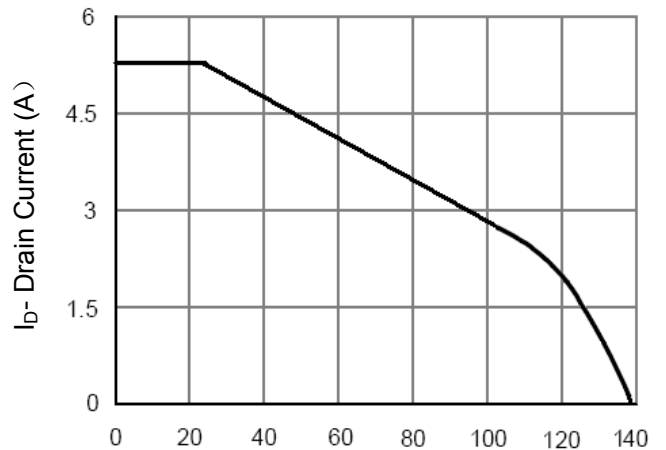

Figure 2: Switching Waveforms



T<sub>J</sub>-Junction Temperature(°C)  
Figure 3 Power Dissipation



T<sub>J</sub>-Junction Temperature(°C)  
Figure 4 Drain Current

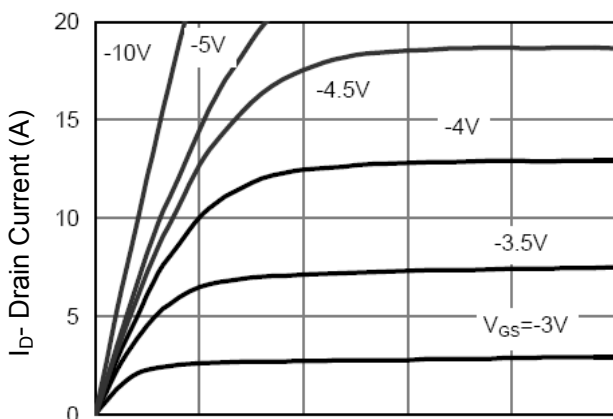

V<sub>ds</sub> Drain-Source Voltage (V)  
Figure 5 Output Characteristics

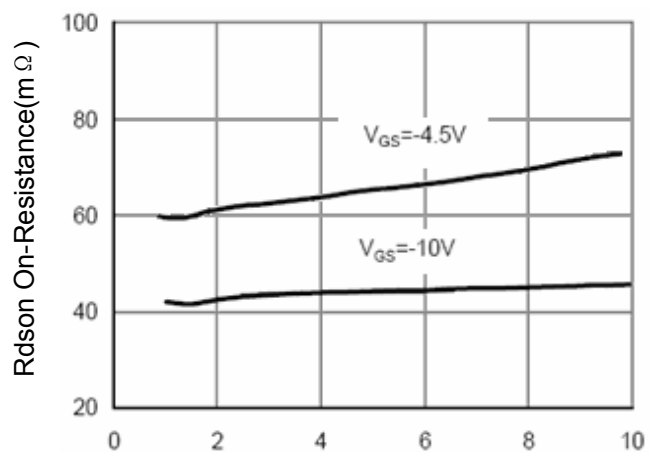

Figure 6 Drain-Source On-Resistance

Figure 5 Output Characteristics

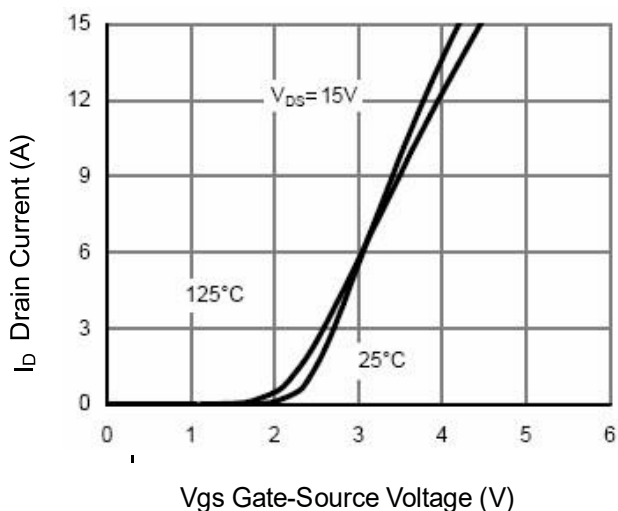

Figure 7 Transfer Characteristics

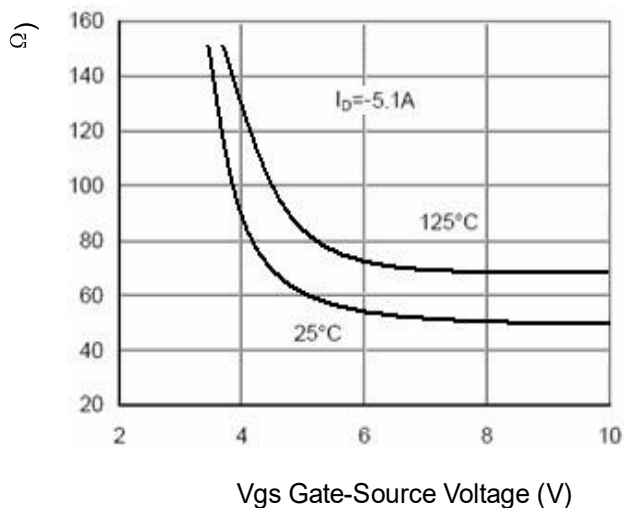

Figure 9 Rds(on) vs Vgs

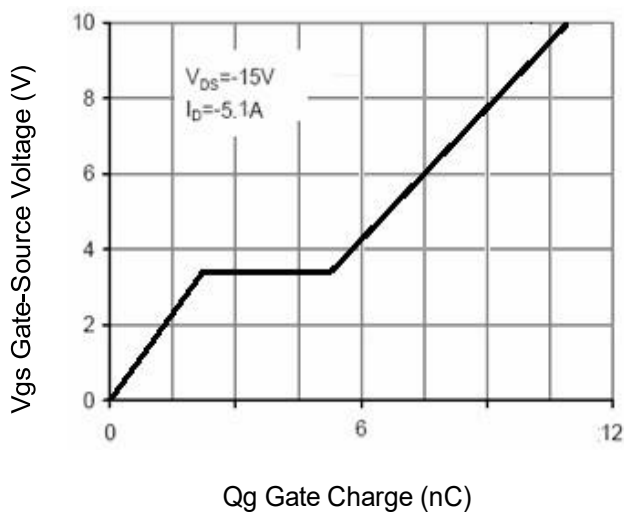

Figure 11 Gate Charge

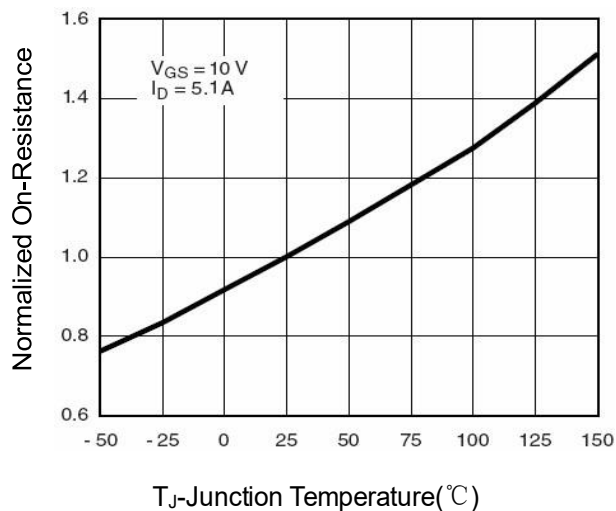

Figure 10 Capacitance vs Vds

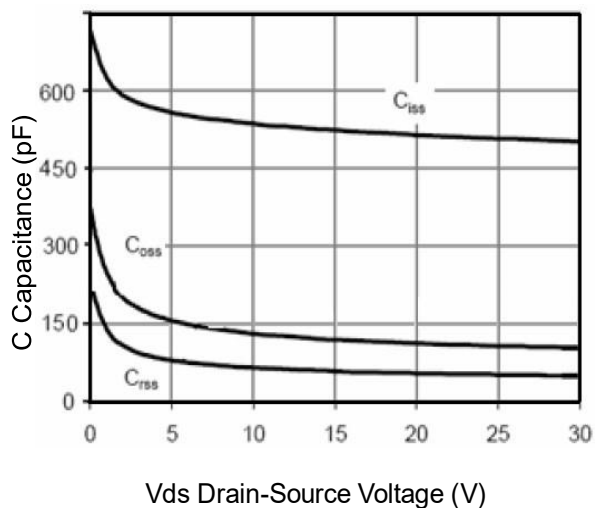
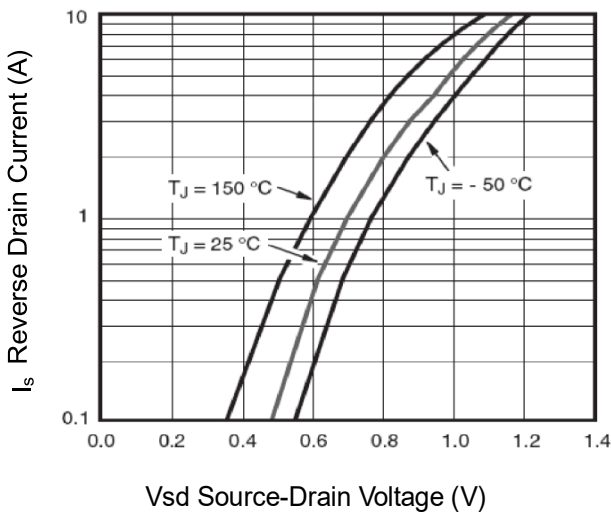

Figure 12 Source- Drain Diode Forward



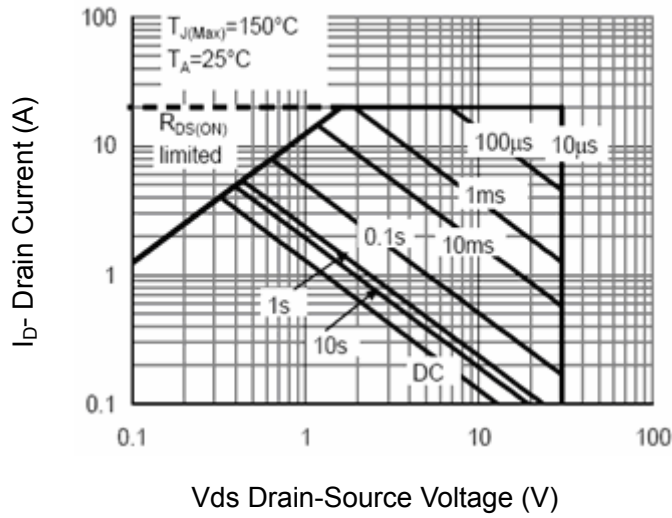

Figure 13 Safe Operation Area

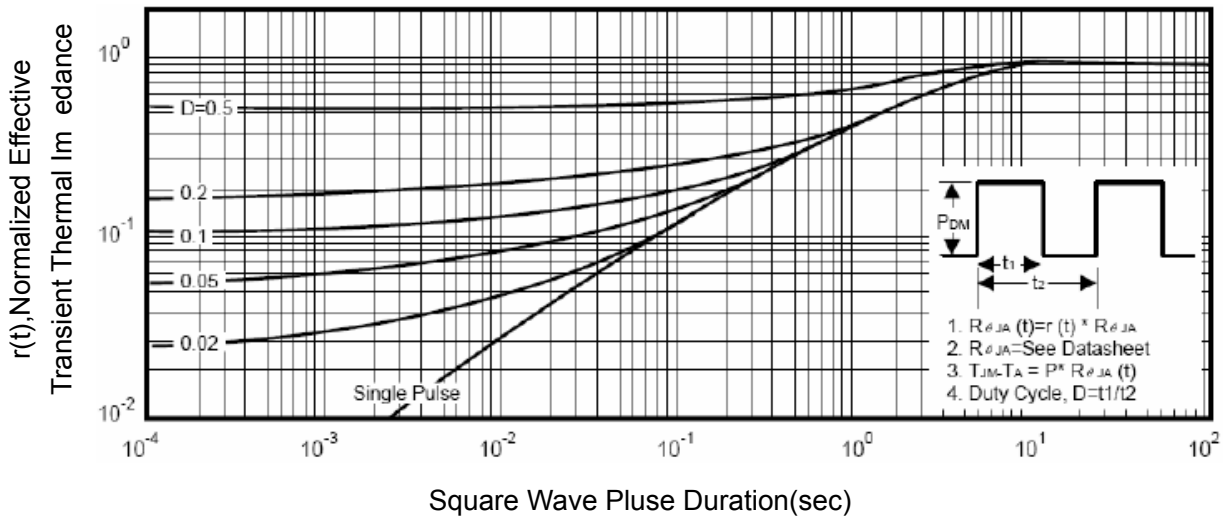
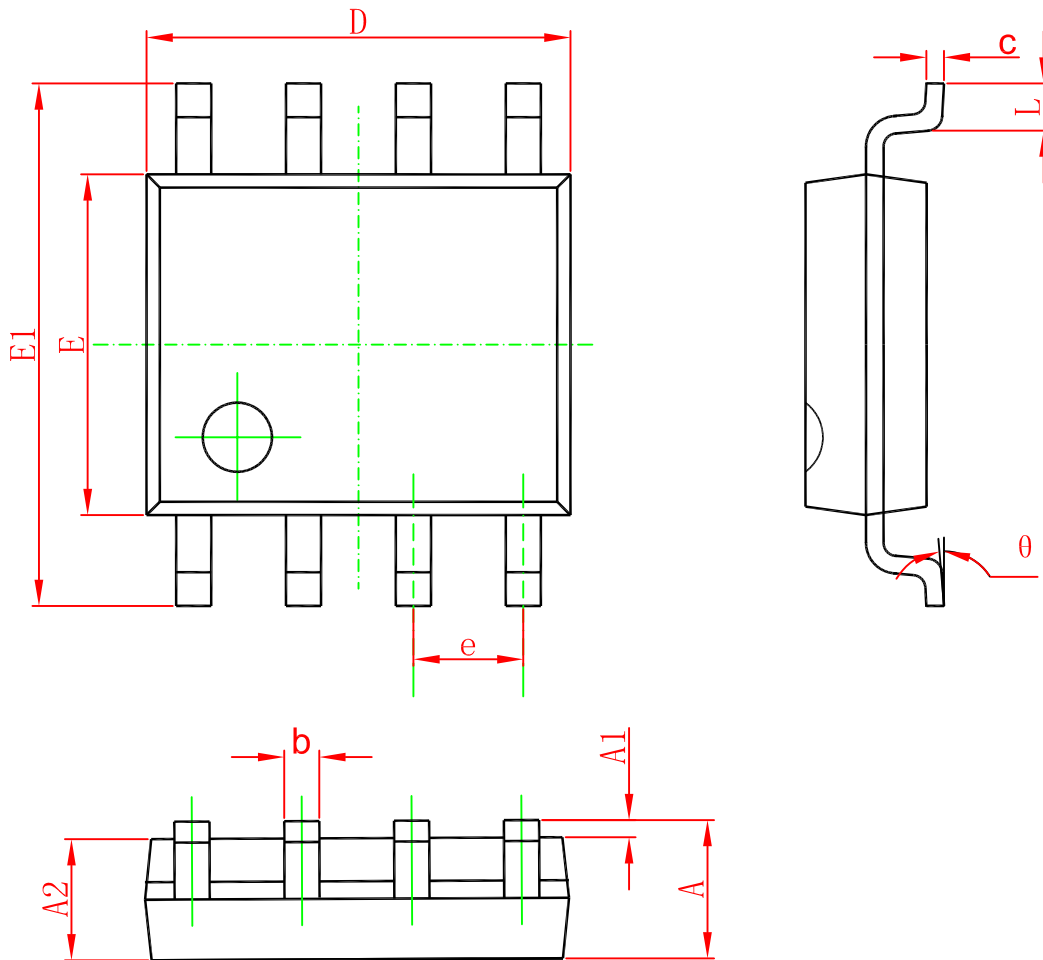

Figure 14 Normalized Maximum Transient Thermal Impedance

SOP-8



Symbol	Dimensions In Millimeters		Dimensions In Inches	
	Min	Max	Min	Max
A	1.350	1.750	0.053	0.069
A1	0.100	0.250	0.004	0.010
A2	1.350	1.550	0.053	0.061
b	0.330	0.510	0.013	0.020
c	0.170	0.250	0.006	0.010
D	4.700	5.100	0.185	0.200
E	3.800	4.000	0.150	0.157
E1	5.800	6.200	0.228	0.244
e	1.270(BSC)		0.050(BSC)	
L	0.400	1.270	0.016	0.050
θ	0°	8°	0°	8°

**Marking**

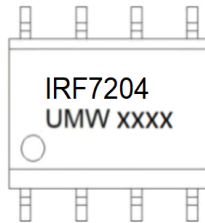

**Ordering information**

Order code	Package	Baseqty	Deliverymode
UMW IRF7204TR	SOP-8	3000	Tape and reel