

150W isolated DC-DC converter
Ultra-wide input and regulated single output

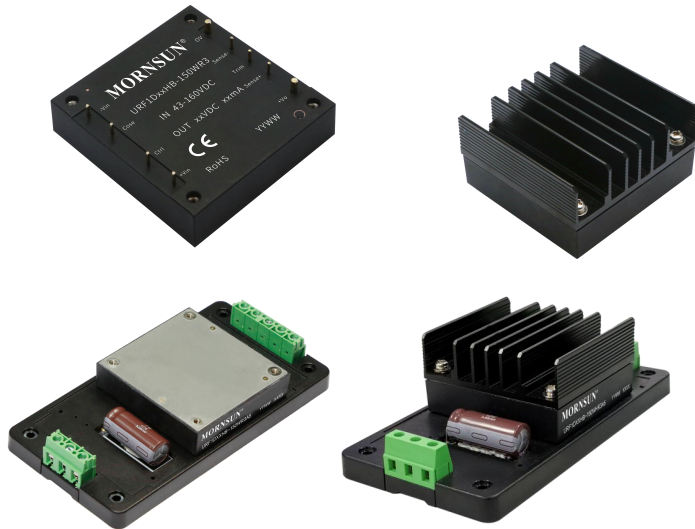

CE Patent Protection RoHS 

EN 50155

URF1D_HB-150W(H)R3(A5) series is a high-performance product specifically designed for a variety of railway applications. The DC-DC converters feature up to 150W output power with no requirement for minimum load, ultra-wide input voltage from 43-160VDC. The products also provide input under-voltage protection, output over-voltage, short-circuit and over-temperature protection. Additional functions include remote On/Off control, remote sense compensation and output voltage trim adjustment. EN50155 approved and they are widely used in railway systems and associated equipment.

FEATURES

- Ultra-wide input voltage range: 43-160VDC
- High efficiency up to 90%
- Low no-load power consumption
- Reinforced insulation, input - output isolation test voltage: 3k VAC, input - case isolation test voltage: 2.1k VAC
- Operating ambient temperature range: -40°C to +105°C
- Input under-voltage protection, output short-circuit, over-current, over-voltage, over-temperature protection
- Industry standard 1/2 brick
- EN50155 approved

Selection Guide

Certification	Part No. ^①	Input Voltage (VDC)			Output		Full Load Efficiency (%) Min./Typ.	Max. Capacitive Load(μF)
		Nominal	Range	Max. ^②	Voltage (VDC)	Current (mA) Max./Min.		
EN	URF1D05HB-150W(H)R3(A5)	110	43-66	170	5	19200/0	86/88	26400
						24000/0		33000
	URF1D12HB-150W(H)R3(A5)		43-66		12	10000/0	87/89	10000
						12500/0		12500
	URF1D15HB-150W(H)R3(A5)		43-66		15	8000/0	87/89	5400
						10000/0		6800
	URF1D24HB-150W(H)R3(A5)		43-66		24	4375/0	87/89	3080
						6250/0		4400
	URF1D48HB-150W(H)R3(A5)		43-66		48	2496/0	86/88	800
						3120/0		1000

Note: ① Use "H" suffix for heat sink mounting, "A5" suffix for chassis mounting. We recommend to choose modules with a heat sink for enhanced heat dissipation and applications with extreme temperature requirements;
 ② Exceeding the maximum input voltage may cause permanent damage.
 ③ The minimum input voltage and starting voltage of A5 Model are 1VDC higher than those of horizontal package due to input reverse polarity protection function.
 ④ Efficiencies for A5 Model's is decreased by 2% due to the input reverse polarity protection function.

Input Specifications

Item	Operating Conditions	Min.	Typ.	Max.	Unit
Input Current (full load / no-load)	Nominal input voltage	5VDC output	--	1240/25	1586/45
		12VDC, 15VDC output	--	1533/25	1568/45
		24VDC output	--	1516/25	1550/45
		48VDC output	--	1548/25	1584/45

Reflected Ripple Current	Nominal input voltage	--	100	--	mA
Surge Voltage (1sec. max.)		-0.7	--	180	VDC
Start-up Voltage		--	--	43	
Under-voltage Protection		--	40	--	
Input Filter		PI filter			
Hot Plug		Unavailable			
Ctrl*	Module on	Ctrl pin open or pulled high (3.5-12VDC)			
	Module off	Ctrl pin -Vin or pulled low (0-1.2VDC)			
	Input current when off	--	2	8	mA

Note: *The Ctrl pin voltage is referenced to input -Vin.

Output Specifications

Item	Operating Conditions	Min.	Typ.	Max.	Unit	
Voltage Accuracy	Nominal input voltage, 0%-100% load	--	±1	±3	%	
Linear Regulation	Input voltage variation from low to high at full load	--	±0.1	±0.3		
Load Regulation	Nominal input voltage, 0%-100% load	--	±0.3	±0.5		
Transient Recovery Time	25% load step change,	--	200	500	μs	
Transient Response Deviation	nominal input voltage	5VDC output	--	±10	%	
		Others	--	±3		±5
Temperature Coefficient	Full load	--	--	±0.03	%/°C	
Ripple & Noise *	20MHz bandwidth, 10%-100%Io load	48VDC output	--	200	300	mVp-p
		Others	--	100	200	
Trim		90	--	110	%	
Output Voltage Remote Compensation (sense)		--	--	105		
Over-temperature Protection	Surface max. temperature	--	105	115	°C	
Over-voltage Protection	Input voltage range	5VDC output	110	--	160	%Vo
		Others	110	--	140	
Over-current Protection	Input voltage range	110	140	190	%Io	
Short-circuit Protection		Hiccup, continuous, self-recovery				

Note: *Ripple & Noise for 48VDC output at 0%Io-100%Io load ≤ 400mV, others outputs at 0%Io-100%Io load ≤ 300mV. The measuring method of ripple and noise, please refer to Fig. 1.

General Specifications

Item	Operating Conditions	Min.	Typ.	Max.	Unit	
Isolation	Input-output	Electric Strength test for 1 minute with a leakage current of 5mA max.	3000	--	--	VAC
	Input-case		2100	--	--	
	Output-case	Electric Strength test for 1 minute with a leakage current of 1mA max.	1500	--	--	VDC
Insulation Resistance	Input-output resistance at 500VDC	1000	--	--	MΩ	
Isolation Capacitance	Input-output capacitance at 100KHz/0.1V	--	2200	--	pF	
Switching Frequency	PFM mode	--	170	--	KHz	
MTBF	MIL-HDBK-217F@25°C	500	--	--	K hours	

Environmental Specifications

Item	Operating Conditions	Min.	Typ.	Max.	Unit
Operating Temperature Range	According to the operating temperature range	-40	--	+105	°C
Storage Humidity	Non-condensing	5	--	95	%RH

Storage Temperature		-55	--	+125	°C	
Pin Soldering Resistance Temperature	Soldering spot is 1.5mm away from case for 10 seconds	--	--	+300		
Thermal Resistance	URF1D05HB-150WR3 URF1D12HB-150WR3 URF1D15HB-150WR3 URF1D24HB-150WR3 URF1D48HB-150WR3	100LFM	4.3	--	--	°C/W
	URF1D05HB-150WHR3	Natural convection	3.5	--	--	
		100LFM				
	URF1D12HB-150WHR3 URF1D15HB-150WHR3 URF1D24HB-150WHR3 URF1D48HB-150WHR3	Natural convection	3.4	--	--	
		100LFM	2.8	--	--	
Shock and Vibration Test		IEC/EN61373 - Category 1, Grade B				

Mechanical Specifications

Case Material	Black plastic; flame-retardant and heat-resistant (UL94-V0) & Aluminum alloy case	
Dimensions	URF1D_HB-150WR3	61.00 x 58.00 x 13.80mm
	URF1D_HB-150WHR3	62.00 x 58.00 x 31.80mm
	URF1D_HB-150WR3A5	135.00 x 70.00 x 22.40mm
	URF1D_HB-150WHR3A5	135.00 x 70.00 x 40.40mm
Weight	URF1D_HB-150WR3	139.0g(Typ.)
	URF1D_HB-150WHR3	194.0g(Typ.)
	URF1D_HB-150WR3A5	219.0g(Typ.)
	URF1D_HB-150WHR3A5	274.0g(Typ.)
Cooling Method	Free air convection or forced convection	

Electromagnetic Compatibility (EMC)

Emissions	CE	CISPR32/EN55032	150kHz-30MHz	Class B (see Fig. 3 for recommended circuit)		
	RE*	CISPR32/EN55032	30MHz-1GHz	Class B (see Fig. 3 for recommended circuit)		
Immunity	ESD	IEC/EN61000-4-2	GB/T17626.2	Contact ±6KV, Air ±8KV	perf.Criteria A	
	RS	IEC/EN61000-4-3	GB/T17626.3	20V/m	perf.Criteria A	
	CS	IEC/EN61000-4-6	GB/T17626.6	10Vr.m.s	perf.Criteria A	
	EFT	IEC/EN61000-4-4	GB/T17626.4	±2KV (5kHz, 100kHz) (see Fig. 3 for recommended circuit)	perf.Criteria A	
	Surge	IEC/EN61000-4-5	GB/T17626.5	line to line ±2KV (1.2 μs/50 μs 2 Ω) (see Fig. 3 for recommended circuit)		perf.Criteria A

Note: *The standard only suit for URF1D_HB-150WR3 series (without heatsink).

Electromagnetic Compatibility (EMC) (EN50155)

Emissions	CE	EN50121-3-2	150kHz-500kHz	99dBuV (see Fig. 2 for recommended circuit)	
		EN55016-2-1	500kHz-30MHz	93dBuV (see Fig. 2 for recommended circuit)	
	RE	EN50121-3-2	30MHz-230MHz	40dBuV/m at 10m (see Fig. 2 for recommended circuit)	
		EN55016-2-1	230MHz-1GHz	47dBuV/m at 10m (see Fig. 2 for recommended circuit)	
Immunity	ESD	EN50121-3-2	Contact ±6KV/Air ±8KV		perf. Criteria A
	RS	EN50121-3-2	20V/m		perf. Criteria A
	EFT	EN50121-3-2	±2kV 5/50ns	5kHz (see Fig. 2 for recommended circuit)	perf. Criteria A
	Surge	EN50121-3-2	line to line ±1KV (42 Ω, 0.5 μF) (see Fig. 2 for recommended circuit)		perf. Criteria A
	CS	EN50121-3-2	0.15MHz-80MHz	10V r.m.s	

Typical Characteristic Curves

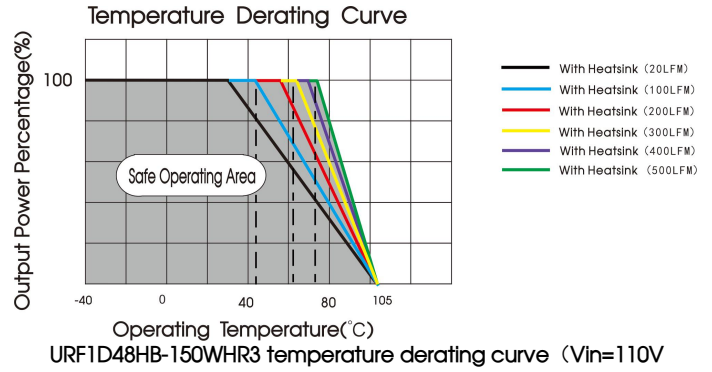
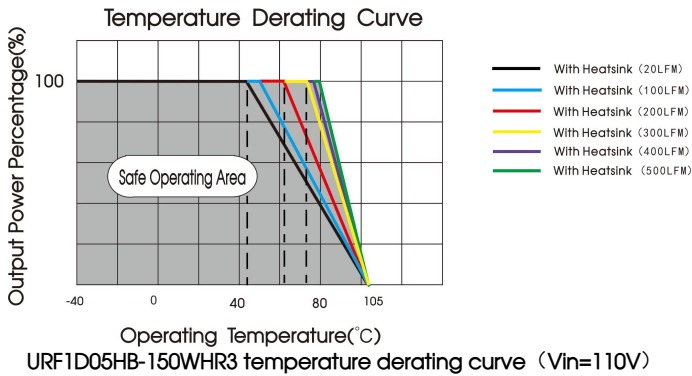

Notes:
1. Temperature derating curves and efficiency curves are typical test values.

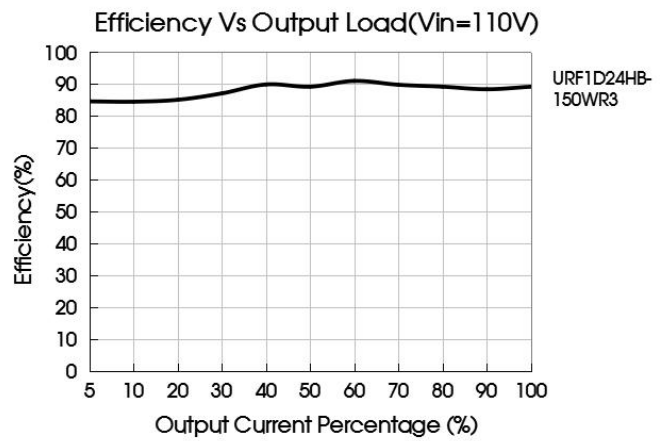
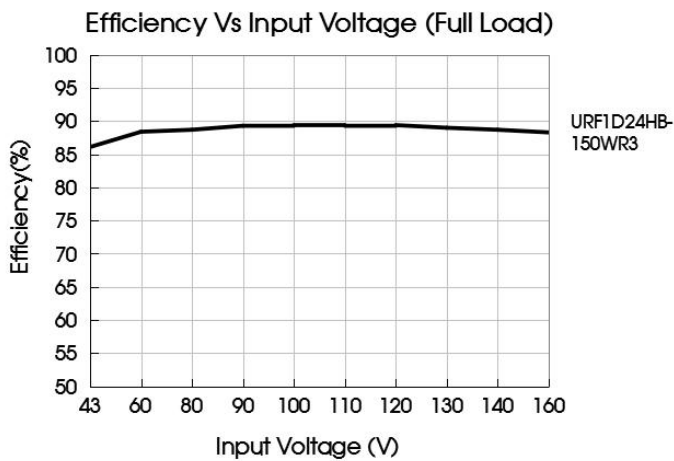
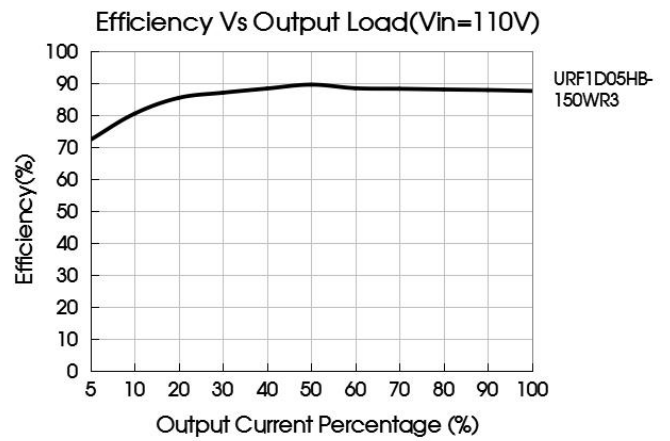
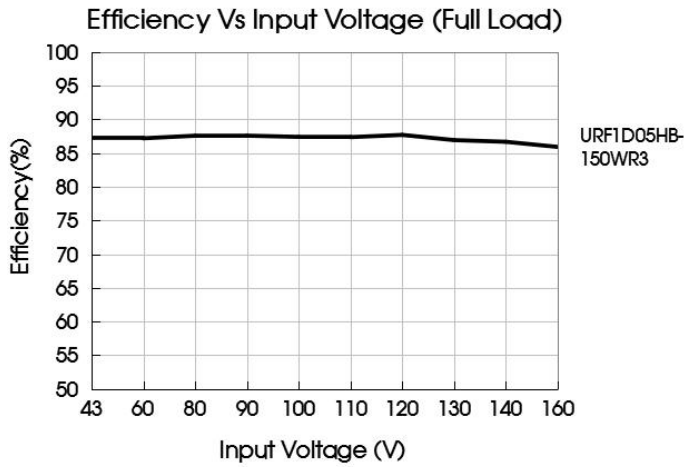

Remote Sense Application

1. Remote Sense Connection if not used

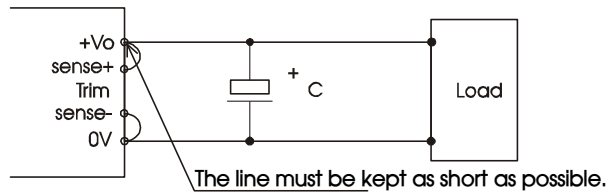

Notes:

- (1) If the sense function is not used for remote regulation the user must connect the +Sense to + Vo and -Sense to 0V at the DC-DC converter pins and will compensate for voltage drop across pins only.
- (2) The connections between Sense lines and their respective power lines must be kept as short as possible, otherwise they may be picking up noise, interference and/or causing unstable operation of the power module.

2. Remote Sense Connection used for Compensation

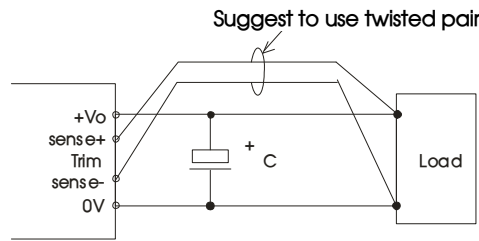

Notes:

- (1) Using remote sense with long wires may cause unstable output, please contact technical support if long wires must be used.
- (2) PCB-tracks or cables/wires for Remote Sense must be kept as short as possible. Twisted pair or shielded wairs are suggested for remote compensation and must be kept as short as possible.
- (3) We recommend using adequate cross section for PCB-track layout and/or cables to connect the power supply module to the load in order to keep the voltage drop below 0.3V and to make sure the power supply's output voltage remains within the specified range.
- (4) Note that large wire impedance may cause oscillation of the output voltage and/or increased ripple. Consult technical support or factory for further advice of sense operation.

Design Reference

1. Ripple & Noise

All the DC-DC converters of this series are tested before delivery using the recommended circuit shown in Fig. 1.

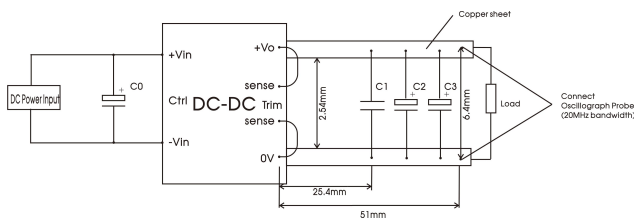

Fig. 1

Capacitors value	C0(μF)	C1(μF)	C2(μF)	C3(μF)
Output voltage				
5VDC	100μF/ 200V	1μF/16V	10μF/16V	330μF/16V
12VDC		1μF/25V	10μF/25V	330μF/25V
15VDC		1μF/25V	10μF/25V	330μF/25V
24VDC		1μF/50V	10μF/50V	330μF/50V
48VDC		1μF/100V	10μF/100V	330μF/100V

Note: A5 package does not need C0 capacitor.

2. Typical application

We recommended using Mornsun's EMC circuit, otherwise please ensure that at least a 100µF electrolytic capacitors is connected at the input in order to ensure adequate voltage surge suppression and protection. Input and/or output ripple can be further reduced by appropriately increasing the input & output capacitor values C_{in} and C_{out} and/or by selecting capacitors with a low ESR (equivalent series resistance). Also make sure that the capacitance is not exceeding the specified max. capacitive load value of the product.



capacitor value Output Voltage	$C_{in}(\mu F)$	$C_{out}(\mu F)$
5VDC	100µF/200V	330µF/16V
12VDC		330µF/25V
15VDC		330µF/25V
24VDC		330µF/50V
48VDC		330µF/100V

3. Trim Function for Output Voltage Adjustment (open if unused)

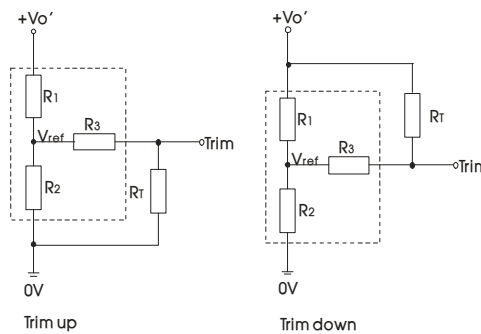

TRIM resistor connection (dashed line shows internal resistor network)

Trim resistor calculation:

$$\begin{aligned} \text{up: } R_T &= \frac{\alpha R_2}{R_2 - \alpha} - R_3 & \alpha &= \frac{V_{ref}}{V_{o'} - V_{ref}} \cdot R_1 \\ \text{down: } R_T &= \frac{\alpha R_1}{R_1 - \alpha} - R_3 & \alpha &= \frac{V_{o'} - V_{ref}}{V_{ref}} \cdot R_2 \end{aligned}$$

Table 1

V_o resistance	5(VDC)	12(VDC)	15(VDC)	24(VDC)	48(VDC)
R1(KΩ)	2.87	11	14.49	24.87	58.69
R2(KΩ)	2.87	2.87	2.87	2.87	3.21
R3(KΩ)	4	11	16	21	7.89
$V_{ref}(V)$	2.5	2.5	2.5	2.5	2.5

Note:

Value for R1, R2, R3, and V_{ref} refer to the above table 1. R_T : Resistance of Trim. α : User-defined parameter, no actual meanings. $V_{o'}$: The trim up/down voltage.

4. EMC compliance circuit

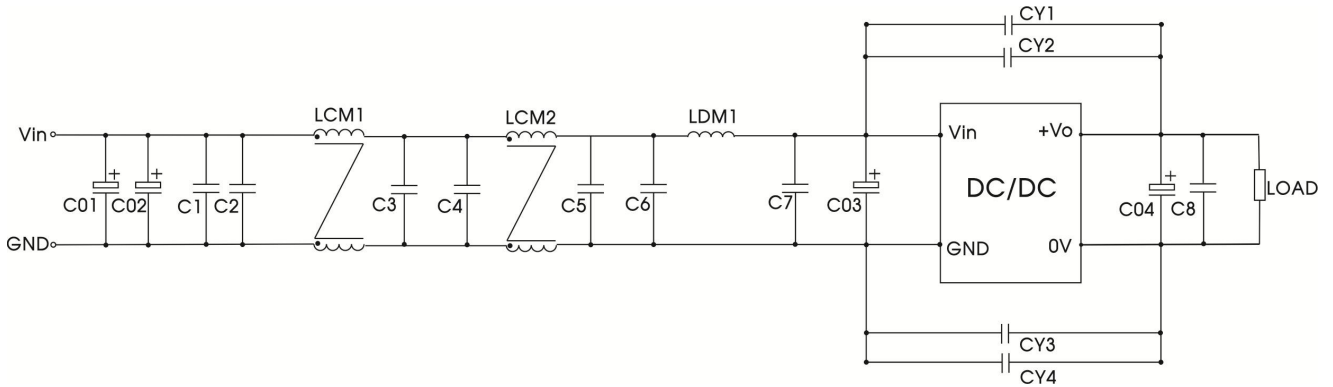

Fig.2

Components	Value
C01, C02, C03	220uF/200V
C04	220uF/63V
LDM1	1.5uH
C1, C2, C3, C4, C5, C6, C7, C8, C9	2.2uF/250V
CY1, CY2, CY3, CY4	2200 pF /400VAC
LCM1	Mornsun' FL2D-30-472
LCM2	Mornsun' FL2D-30-102

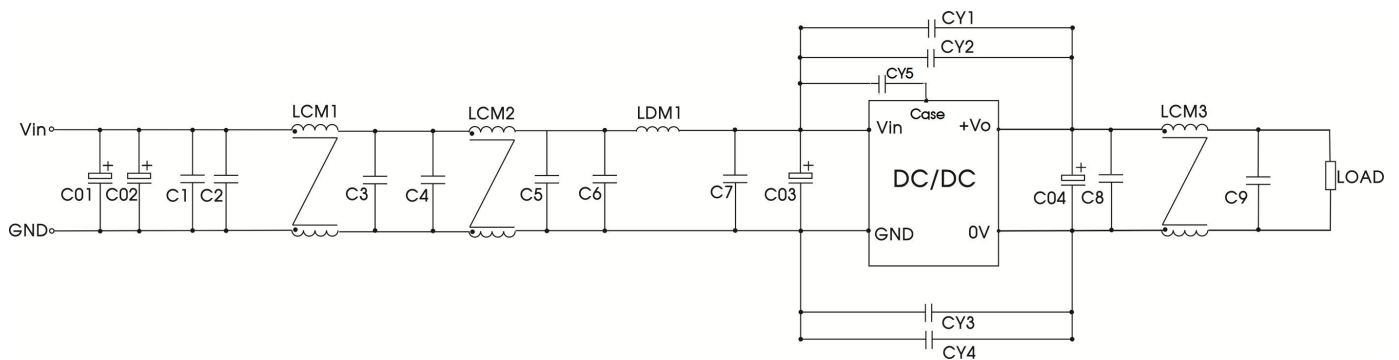

Fig.3

	220uF/200V
C04	220uF/63V
LDM1	1.5uH(Shielded inductor)
C1, C2, C3, C4, C5, C6, C7, C8	2.2uF/250V
CY1, CY2, CY3, CY4	2200 pF /400VAC(Y safety capacitor)
LCM1	Mornsun' FL2D-30-472
LCM2	Mornsun' FL2D-30-102
LCM3	Mornsun' FL2D-70-360C (7A max.)
	Mornsun' FL2D-A3-360C (13A max.)
	Mornsun' FL2D-B5-360C (25A max.)

5. The products do not support parallel connection of their output

6. For additional information please refer to DC-DC converter application notes on www.mornsun-power.com

URF1D_HB-150WR3 Dimensions

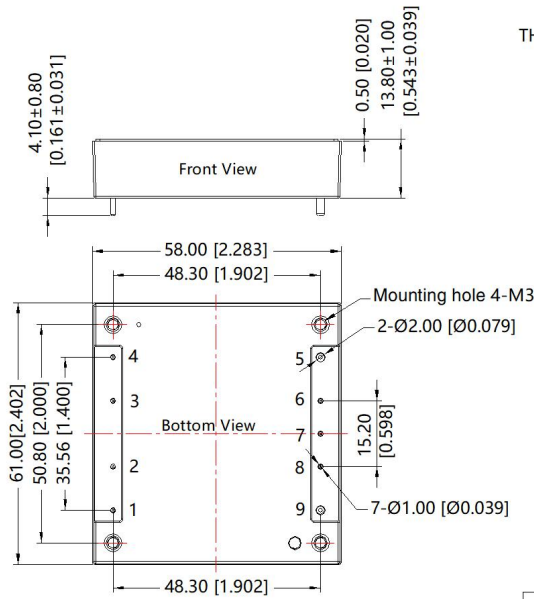

Note:
Unit: mm[inch]
Pin1, 2, 3, 4, 6, 7, 8's diameter: 1.00[0.039]
Pin5, 9's diameter: 2.00[0.079]
Pin diameter tolerances: ± 0.10[± 0.004]
General tolerances: ± 0.50[± 0.020]
Mounting hole screwing torque: Max 0.4 N.m

THIRD ANGLE PROJECTION

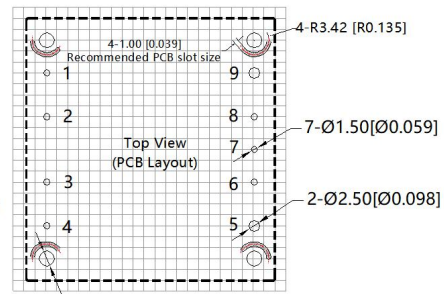

Note: Grid 2.54*2.54mm

Recommended screw length

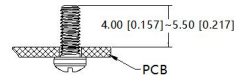

Pin	Mark	Pin	Mark
1	+Vin	6	Sense-
2	Ctrl	7	Trim
3	Case	8	Sense+
4	-Vin	9	+Vo
5	0V		

URF1D_HB-150WHR3 Dimensions

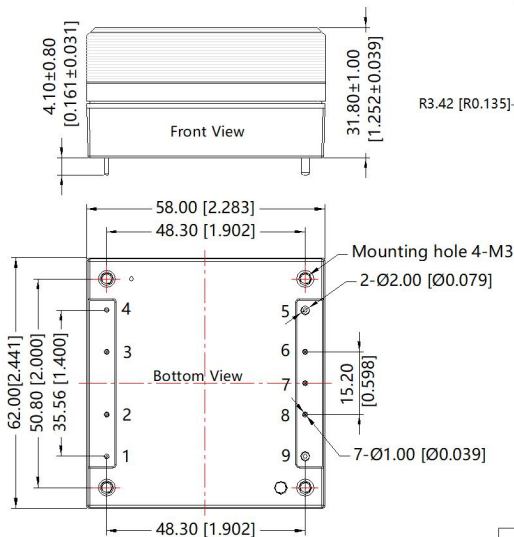

Note:
Unit: mm[inch]
Pin1, 2, 3, 4, 6, 7, 8 diameter: 1.00[0.039]
Pin5, 9 diameter: 2.00[0.079]
Pin diameter tolerances: ± 0.10[± 0.004]
General tolerances: ± 0.50[± 0.020]
Mounting hole screwing torque: Max 0.4 N · m

THIRD ANGLE PROJECTION

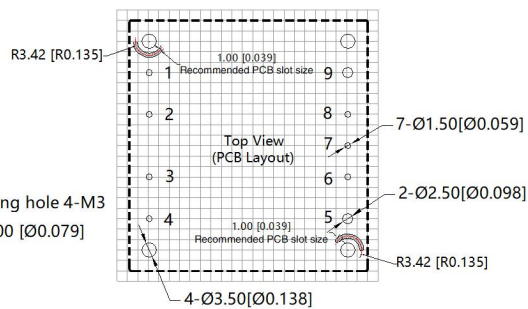

Note: Grid 2.54*2.54mm

Recommended screw length

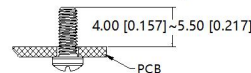

Pin-Out			
Pin	Mark	Pin	Mark
1	+Vin	6	Sense-
2	Ctrl	7	Trim
3	Case	8	Sense+
4	-Vin	9	+Vo
5	0V		

URF1D_HB-150WR3A5 Dimensions

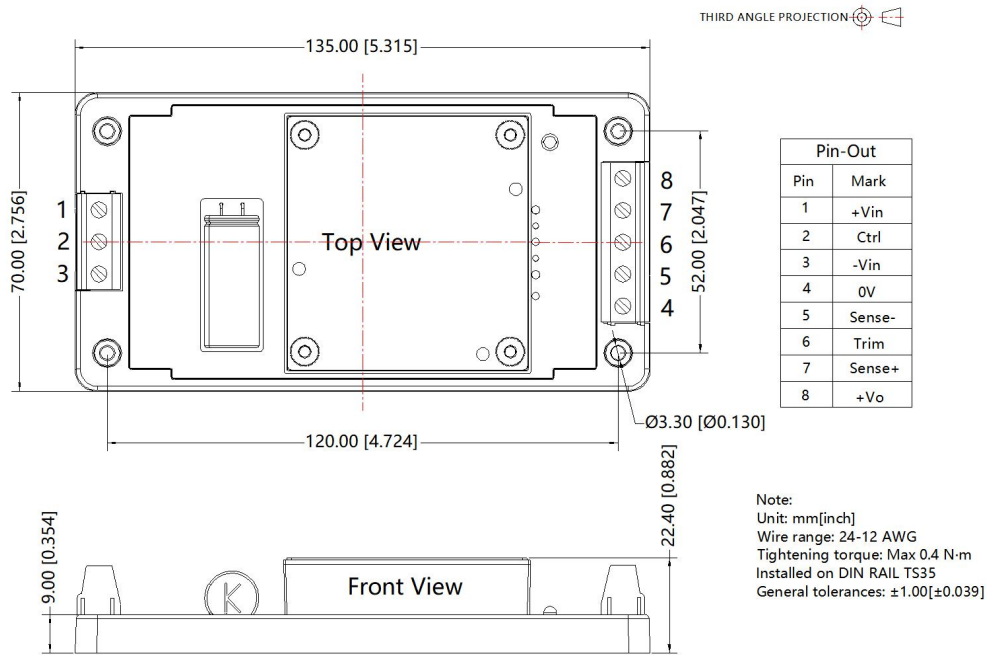

URF1D_HB-150WHR3A5 Dimensions

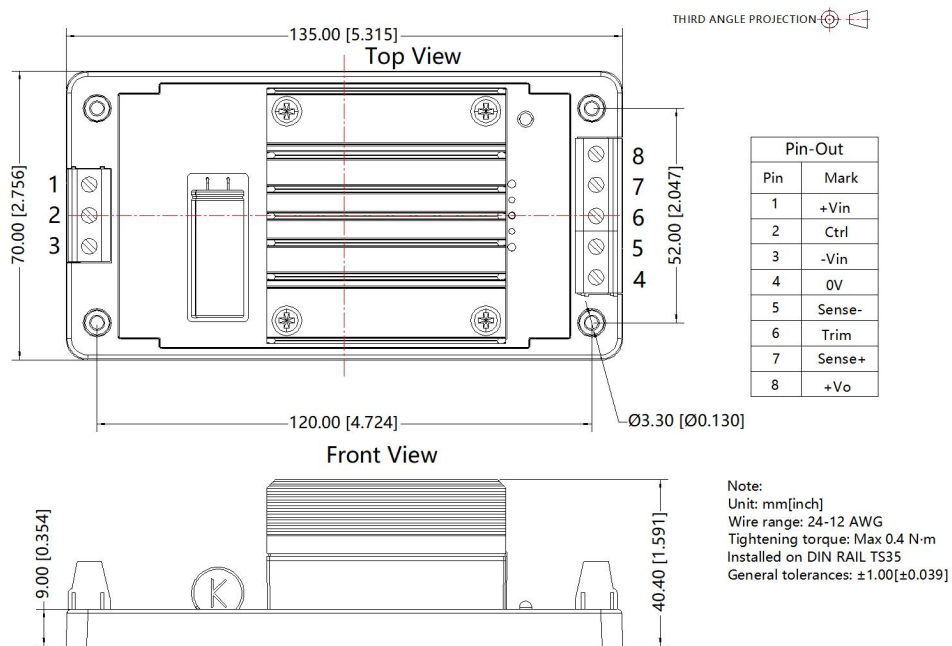

Note:

1. For additional information on Product Packaging please refer to www.mornsun-power.com. The Packaging bag number of Horizontal packaging: 58200069(without heatsink), 58200061(with heatsink), A5 package: 58220031;
2. Recommend to use module with more than 5% load, if not, the ripple of the product may exceeds the specification, but does not affect the reliability of the product;
3. The maximum capacitive load offered were tested at input voltage range and full load;
4. It is suggested to take our recommended circuit for EMC testing. If the customer needs to meet the performance of the surge and without taking recommended solution of ours, please make sure the residual voltage of surge less than 180V;
5. It is suggested that customers use enamel film or thermal grease between the heat sink and the module when using the heat sink to ensure good heat dissipation;
6. Unless otherwise specified, parameters in this datasheet were measured under the conditions of $T_a=25^{\circ}\text{C}$, humidity<75%RH with nominal input voltage and rated output load;
7. All index testing methods in this datasheet are based on company corporate standards;
8. We can provide customized and matched filter modules. For details, please contact our technical staff;
9. Products are related to laws and regulations: see "Features" and "EMC";
10. Our products shall be classified according to ISO14001 and related environmental laws and regulations, and shall be handled by qualified units.

Mornsun Guangzhou Science & Technology Co., Ltd.

Address: No. 5, Kehui St. 1, Kehui Development Center, Science Ave., Guangzhou Science City, Huangpu District, Guangzhou, P. R. China

Tel: 86-20-38601850

Fax: 86-20-38601272

E-mail:info@mornsun.cn

www.mornsun-power.com