

## 500 mA Low-Noise LDO Regulator

### Features

- Output Voltage Range: 1.8V to 15V
- Meets Intel® Slot 1 and Slot 2 Requirements
- Guaranteed 500 mA Output Over the Full Operating Temperature Range
- Low 500 mV Maximum Dropout Voltage at Full Load
- Extremely Tight Load and Line Regulation
- Thermally Efficient Surface-Mount Package
- Low Temperature Coefficient
- Current and Thermal Limiting
- Reversed-Battery Protection
- No-Load Stability
- 1% Output Accuracy
- Ultra-Low-Noise Capability in SOIC-8 and DDPAK
- Ultra-Small 3 mm × 3 mm VDFN Package

### Applications

- Pentium II Slot 1 and Slot 2 Support Circuits
- Laptop, Notebook, and Palmtop Computers
- Cellular Telephones
- Consumer and Personal Electronics
- SMPS Post-Regulator and DC/DC Modules
- High-Efficiency Linear Power Supplies

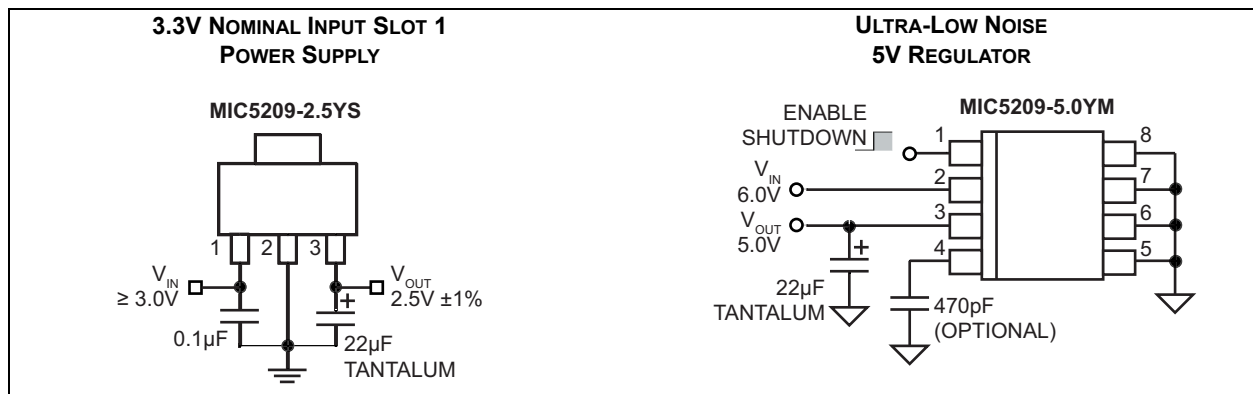
### General Description

The MIC5209 is an efficient linear voltage regulator with very low dropout voltage, typically 10 mV at light loads and less than 500 mV at full load, with better than 1% output voltage accuracy.

Designed especially for hand-held, battery-powered devices, the MIC5209 features low ground current to help prolong battery life. An enable/shutdown pin on the SOIC-8 and DDPAK versions can further improve battery life with near-zero shutdown current.

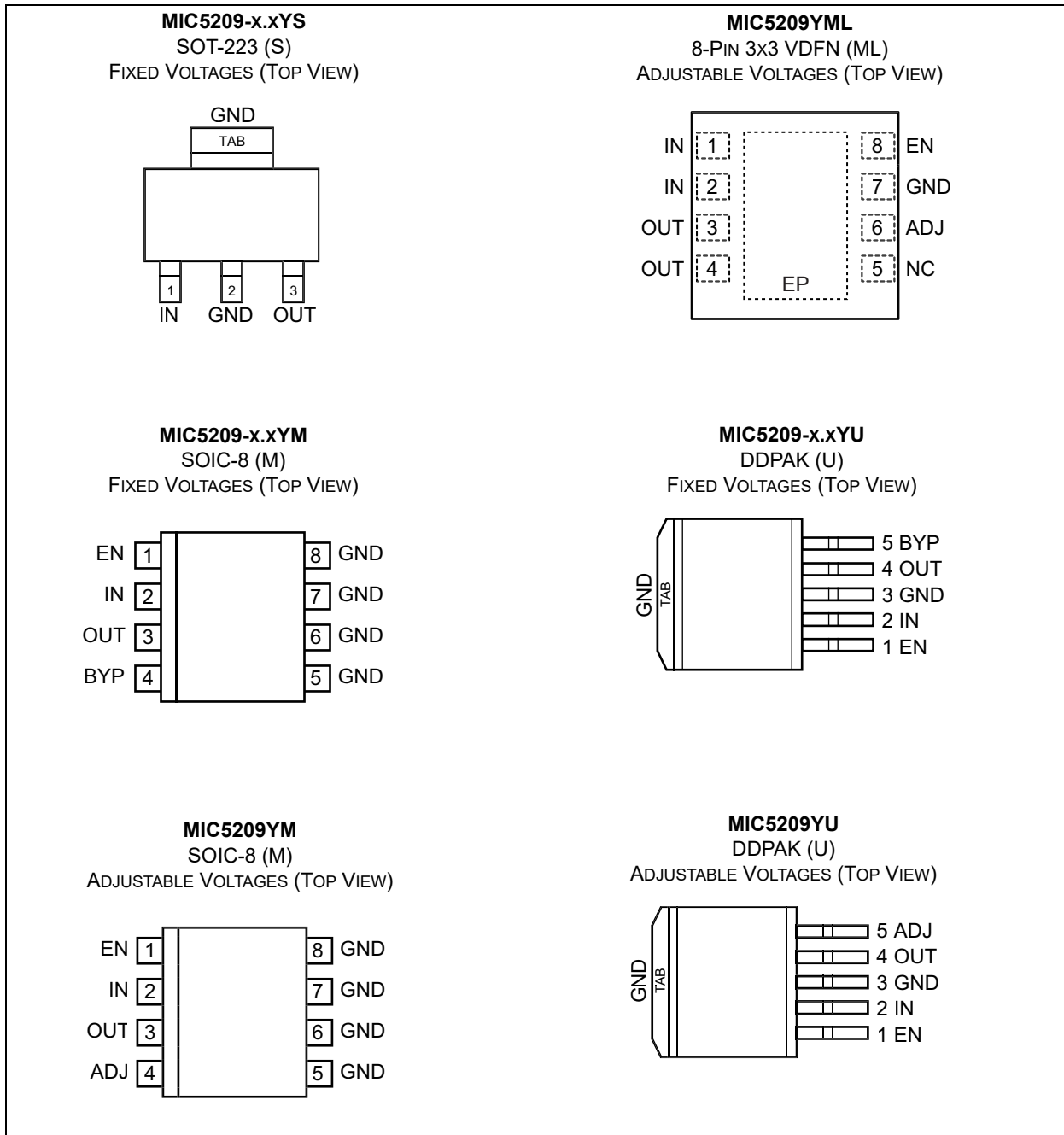
Key features include reversed-battery protection, current limiting, overtemperature shutdown, ultra-low-noise capability (SOIC-8 and DDPAK versions), and is available in thermally efficient packaging. The MIC5209 is available in adjustable or fixed output voltages.

### Typical Application Circuits

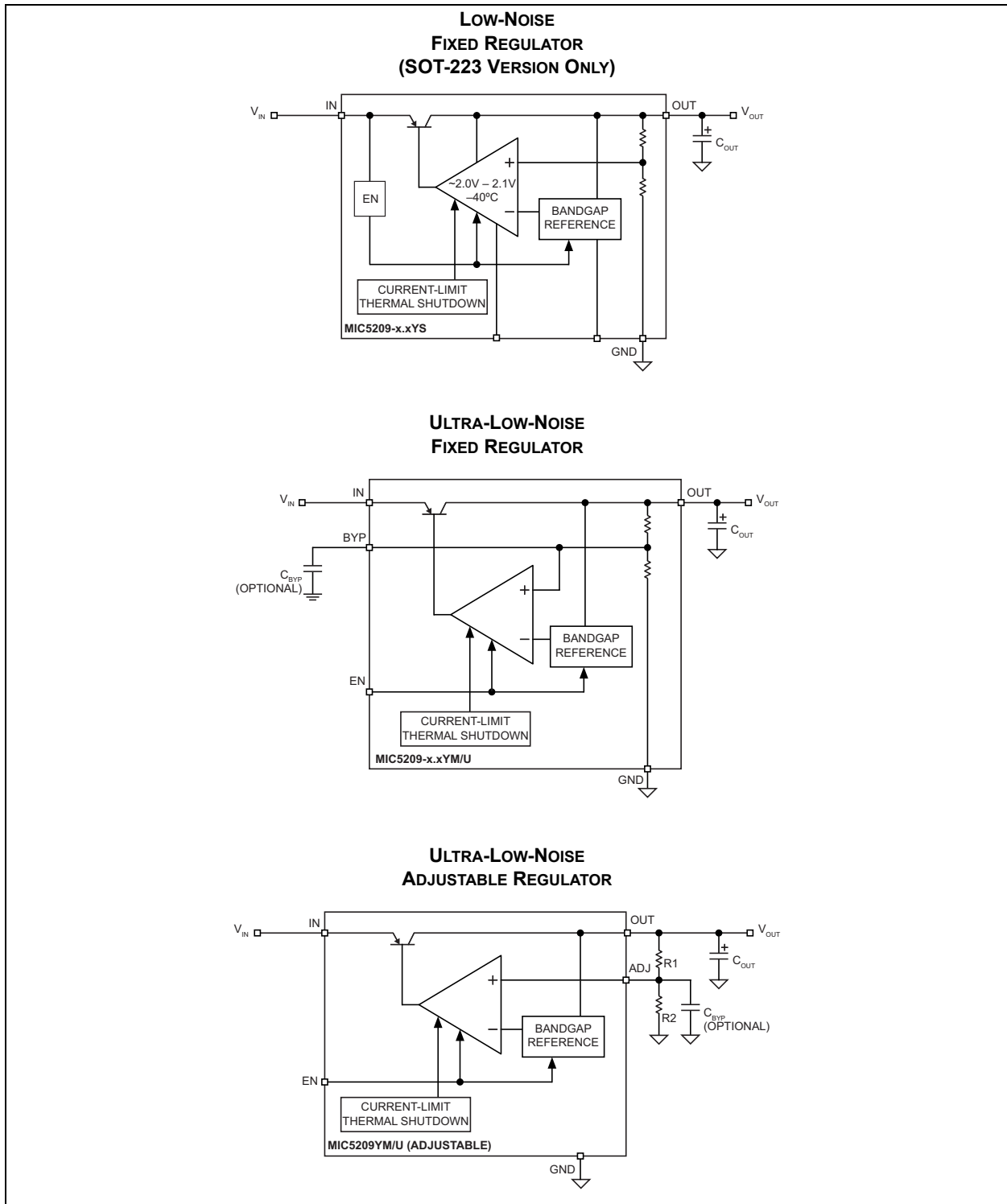


# MIC5209

## Package Types



## Functional Diagrams



# MIC5209

---

---

## 1.0 ELECTRICAL CHARACTERISTICS

### Absolute Maximum Ratings †

Supply Voltage ( $V_{IN}$ ).....	-20V to +20V
Power Dissipation ( $P_D$ ) (Note 1).....	Internally Limited
ESD Rating (SOT-223).....	2 kV HBM/300V MM
ESD Rating (VDFN, SOIC-8).....	5 kV HBM/100V MM

### Operating Ratings ‡

Supply Voltage ( $V_{IN}$ ).....	+2.5V to +16V
Adjustable Output Voltage Range ( $V_{OUT}$ ).....	+1.8V to +15V

† **Notice:** Stresses above those listed under “Absolute Maximum Ratings” may cause permanent damage to the device. This is a stress rating only and functional operation of the device at those or any other conditions above those indicated in the operational sections of this specification is not intended. Exposure to maximum rating conditions for extended periods may affect device reliability.

‡ **Notice:** The device is not guaranteed to function outside its operating ratings.

**Note 1:** The maximum allowable power dissipation at any  $T_A$  (ambient temperature) is  $P_{D(max)} = (T_{J(max)} - T_A) \times \theta_{JA}$ . Exceeding the maximum allowable power dissipation will cause excessive die temperature, and the regulator will go into thermal shutdown. See [Table 4-1](#) and the [Thermal Considerations](#) sub-section in [Applications Information](#) for details.

## ELECTRICAL CHARACTERISTICS

**Electrical Characteristics:**  $V_{IN} = V_{OUT} + 1V$ ;  $I_L = 100 \mu A$ ;  $T_J = +25^\circ C$ , **bold** values indicate  $-40^\circ C \leq T_J \leq +125^\circ C$  except  $0^\circ C \leq T_J \leq +125^\circ C$  for  $1.8V \leq V_{OUT} \leq 2.5V$ , unless noted. [Note 1](#)

Parameter	Symbol	Min.	Typ.	Max.	Units	Conditions
Output Voltage Accuracy	$V_{OUT}$	-1	—	1	%	Variation from nominal $V_{OUT}$
		<b>-2</b>	—	<b>2</b>		
Output Voltage Temperature Coefficient	$\Delta V_{OUT}/\Delta T$	—	<b>40</b>	—	ppm/ $^\circ C$	<a href="#">Note 2</a>
Line Regulation	$\Delta V_{OUT}/V_{OUT}$	—	0.009	0.05	%	$V_{IN} = V_{OUT} + 1V$ to 16V
		—	—	<b>0.10</b>		
Load Regulation	$\Delta V_{OUT}/V_{OUT}$	—	0.05	0.5	%	$I_L = 100 \mu A$ to 500 mA, <a href="#">Note 3</a>
		—	—	<b>0.7</b>		
Dropout Voltage, ( <a href="#">Note 4</a> )	$V_{IN} - V_{OUT}$	—	10	60	mV	$I_L = 100 \mu A$
		—	—	<b>80</b>		
		—	115	175		
		—	—	<b>250</b>		
		—	165	300		
		—	—	<b>400</b>		
		—	350	500		
Ground Pin Current ( <a href="#">Note 5</a> , <a href="#">Note 6</a> )	$I_{GND}$	—	80	130	$\mu A$	$V_{EN} \geq 3.0V$ , $I_{OUT} = 100 \mu A$
		—	—	<b>170</b>		
		—	350	650		
		—	—	<b>900</b>		
		—	1.8	2.5	mA	$V_{EN} \geq 3.0V$ , $I_{OUT} = 150 mA$
		—	—	<b>3.0</b>		
		—	8	20		
		—	—	<b>25</b>		
Ground Pin Quiescent Current, ( <a href="#">Note 6</a> )	$I_{GND}$	—	0.05	<b>3</b>	$\mu A$	$V_{EN} \leq 0.4V$ (shutdown)
		—	0.10	<b>8</b>		$V_{EN} \leq 0.18V$ (shutdown)
Ripple Rejection	PSRR	—	75	—	dB	$f = 120 Hz$
Current Limit	$I_{LIMIT}$	—	700	900	mA	$V_{OUT} = 0V$
		—	—	<b>1000</b>		
Thermal Regulation	$\Delta V_{OUT}/\Delta P_D$	—	0.05	—	%/W	<a href="#">Note 7</a>
Output Noise, ( <a href="#">Note 8</a> )	$e_n$	—	500	—	nV $\sqrt{Hz}$	$V_{OUT} = 2.5V$ , $I_{OUT} = 50 mA$ $C_{OUT} = 2.2 \mu F$ , $C_{BYP} = 0$
		—	300	—		$I_{OUT} = 50 mA$ , $C_{OUT} = 2.2 \mu F$ $C_{BYP} = 470 pF$

# MIC5209

## ELECTRICAL CHARACTERISTICS (CONTINUED)

**Electrical Characteristics:**  $V_{IN} = V_{OUT} + 1V$ ;  $I_L = 100 \mu A$ ;  $T_J = +25^\circ C$ , **bold** values indicate  $-40^\circ C \leq T_J \leq +125^\circ C$  except  $0^\circ C \leq T_J \leq +125^\circ C$  for  $1.8V \leq V_{OUT} \leq 2.5V$ , unless noted. [Note 1](#)

Parameter	Symbol	Min.	Typ.	Max.	Units	Conditions
<b>Enable Input</b>						
Enable Input Logic-Low Voltage	$V_{ENL}$	—	—	0.4	V	$V_{EN} = \text{Logic-low (Regulator shutdown)}$
		—	—	<b>0.18</b>		
		<b>2.0</b>	—	—	V	$V_{EN} = \text{Logic-high (Regulator enabled)}$
Enable Input Current	$I_{ENL}$	—	0.01	-1	$\mu A$	$V_{ENL} \leq 0.4V$
		—	<b>0.01</b>	<b>-2</b>		$V_{ENL} \leq 0.18V$
—	$I_{ENH}$	—	5	20	$\mu A$	$V_{ENH} = 2.0V$
		—	—	<b>25</b>		
		—	—	30		$V_{ENH} = 16V$
		—	—	<b>50</b>		

**Note 1:** Specification for packaged product only.

- 2: Output voltage temperature coefficient is defined as the worst-case voltage change divided by the total temperature range.
- 3: Regulation is measured at constant junction temperature using low duty cycle pulse testing. Parts are tested for load regulation in the load range from 100  $\mu A$  to 500 mA. Changes in output voltage due to heating effects are covered by the thermal regulation specification.
- 4: Dropout Voltage is defined as the input to output differential at which the output voltage drops 2% below its nominal value measured at 1V differential.
- 5: Ground pin current is the regulator quiescent current plus pass transistor base current. The total current drawn from the supply is the sum of the load current plus the ground pin current.
- 6:  $V_{EN}$  is the voltage externally applied to devices with the EN (enable) input pin. SOIC-8 (M) and DDPK (U) packages only.
- 7: Thermal regulation is the change in output voltage at a time "t" after a change in power dissipation is applied, excluding load or line regulation effects. Specifications are for a 500 mA load pulse at  $V_{IN} = 16V$  for  $t = 10 \text{ ms}$ .
- 8:  $C_{BYP}$  is an optional, external bypass capacitor connected to devices with a BYP (bypass) or ADJ (adjust) pin. SOIC-8 (M) and DDPK (U) packages only.

## TEMPERATURE SPECIFICATIONS (Note 1)

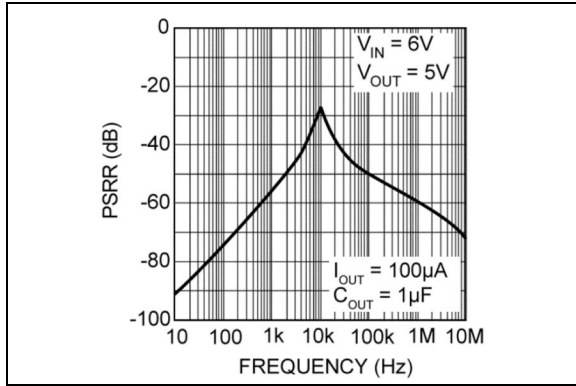
Parameters	Sym.	Min.	Typ.	Max.	Units	Conditions
<b>Temperature Ranges</b>						
Storage Temperature Range	$T_S$	-65	—	+150	°C	—
Lead Temperature	—	—	—	+260	°C	Soldering, 5 sec.
Junction Temperature	$T_J$	-40	—	+125	°C	$2.5V \leq V_{OUT} \leq 15V$
Junction Temperature	$T_J$	0	—	+125	°C	$1.8V \leq V_{OUT} < 2.5V$
<b>Package Thermal Resistance</b>						
Thermal Resistance SOT-223	$\theta_{JA}$	—	62	—	°C/W	EIA/JEDEC
	$\theta_{JC}$	—	15	—	°C/W	JES51-751-7, 4 Layer Board
Thermal Resistance SOIC-8	$\theta_{JA}$	—	50	—	°C/W	See <a href="#">Thermal Considerations</a> for more information.
	$\theta_{JC}$	—	25	—	°C/W	
Thermal Resistance DDPAK	$\theta_{JA}$	—	31.4	—	°C/W	EIA/JEDEC
	$\theta_{JC}$	—	3	—	°C/W	JES51-751-7, 4 Layer Board
Thermal Resistance 3 mm x 3 mm VDFN	$\theta_{JA}$	—	64	—	°C/W	EIA/JEDEC
	$\theta_{JC}$	—	12	—	°C/W	JES51-751-7, 4 Layer Board

**Note 1:** The maximum allowable power dissipation is a function of ambient temperature, the maximum allowable junction temperature and the thermal resistance from junction to air (i.e.,  $T_A$ ,  $T_J$ ,  $\theta_{JA}$ ). Exceeding the maximum allowable power dissipation will cause the device operating junction temperature to exceed the maximum +125°C rating. Sustained junction temperatures above +125°C can impact the device reliability.

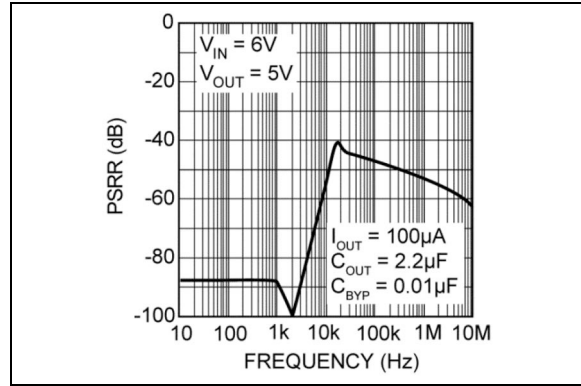
# MIC5209

## 2.0 TYPICAL PERFORMANCE CURVES

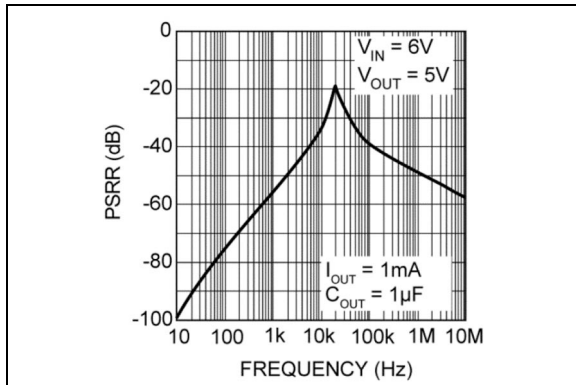
**Note:** The graphs and tables provided following this note are a statistical summary based on a limited number of samples and are provided for informational purposes only. The performance characteristics listed herein are not tested or guaranteed. In some graphs or tables, the data presented may be outside the specified operating range (e.g., outside specified power supply range) and therefore outside the warranted range.



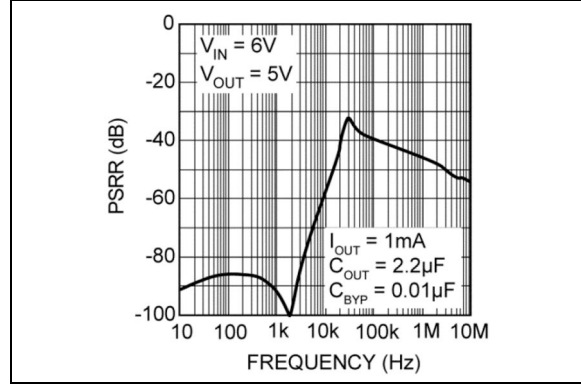
**FIGURE 2-1:** Power Supply Rejection Ratio.



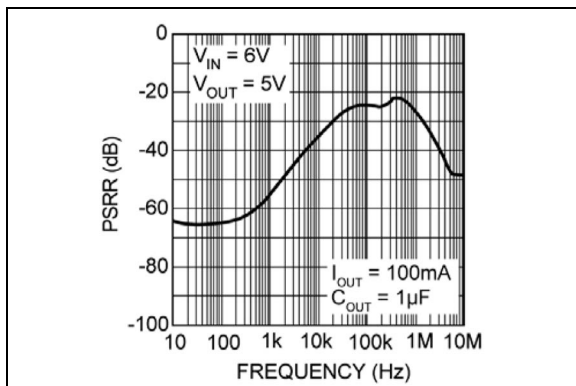
**FIGURE 2-4:** Power Supply Rejection Ratio.



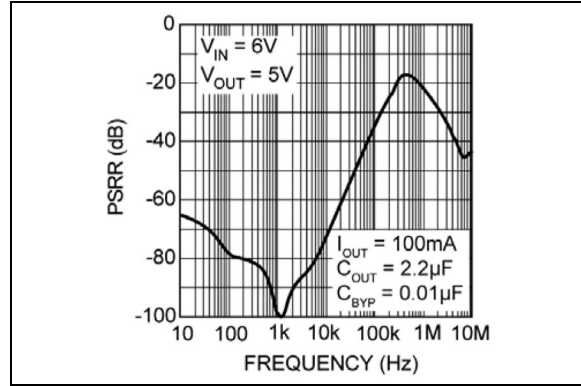
**FIGURE 2-2:** Power Supply Rejection Ratio.



**FIGURE 2-5:** Power Supply Rejection Ratio.

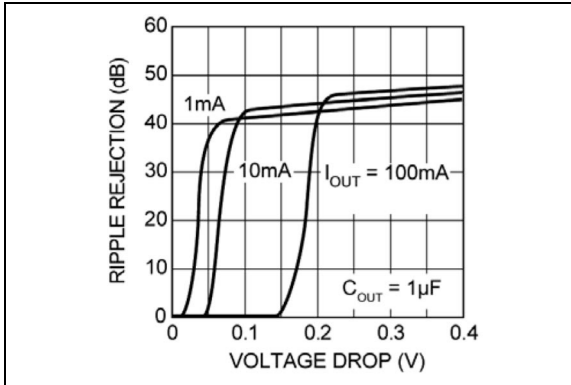


**FIGURE 2-3:** Power Supply Rejection Ratio.

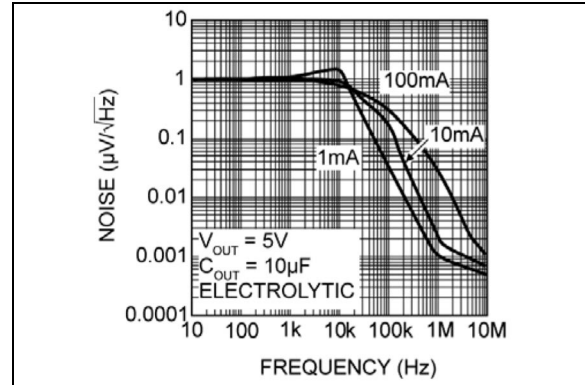


**FIGURE 2-6:** Power Supply Rejection Ratio.

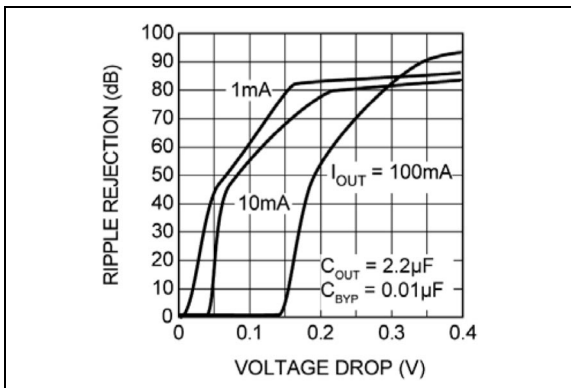




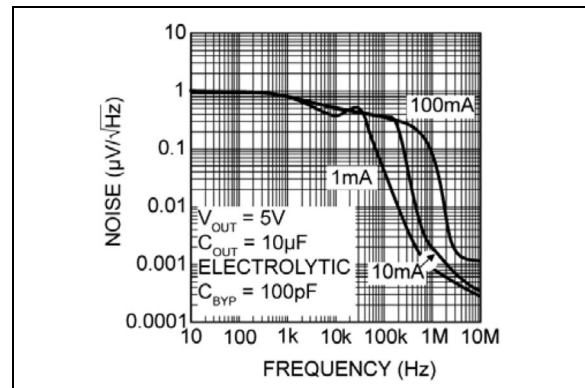
**FIGURE 2-7:** Power Supply Ripple Rejection vs. Voltage Drop.



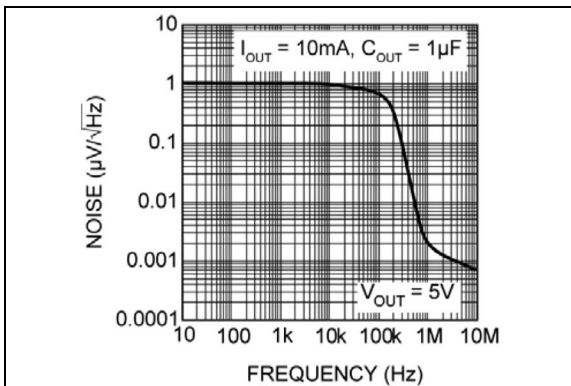
**FIGURE 2-10:** Noise Performance.



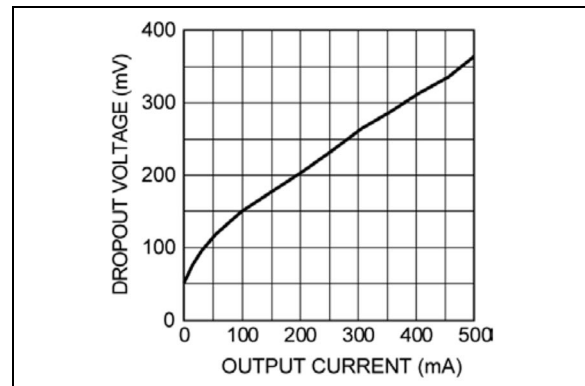
**FIGURE 2-8:** Power Supply Ripple Rejection vs. Voltage Drop.



**FIGURE 2-11:** Noise Performance.

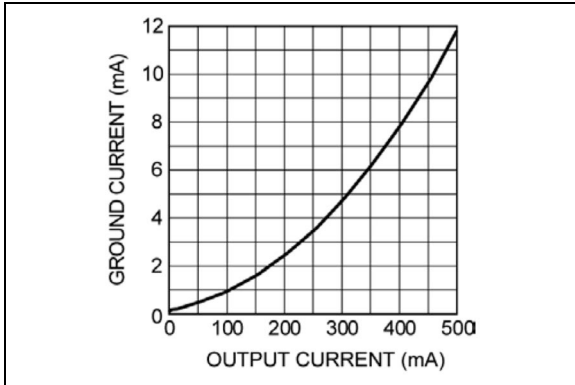


**FIGURE 2-9:** Noise Performance.

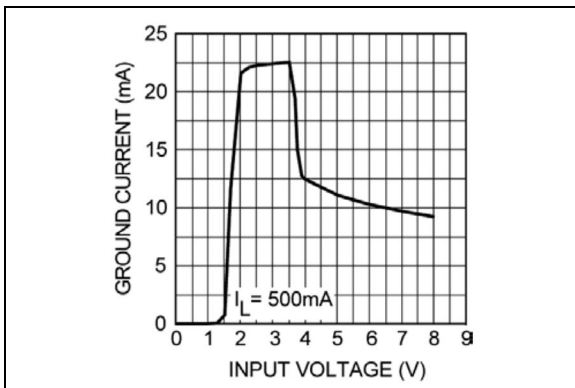


**FIGURE 2-12:** Dropout Voltage vs. Output Current.

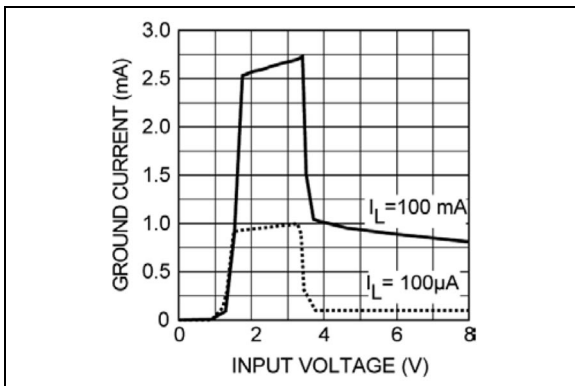
# MIC5209



**FIGURE 2-13:** Ground Current vs. Output Current.



**FIGURE 2-14:** Ground Current vs. Supply Voltage.



**FIGURE 2-15:** Ground Current vs. Supply Voltage.

## 3.0 PIN DESCRIPTIONS

The descriptions of the pins are listed in [Table 3-1](#).

**TABLE 3-1: PIN FUNCTION TABLE**

Pin Number 8-Pin VDFN	Pin Number SOT-223	Pin Number SOIC-8	Pin Number DDPAK	Pin Name	Description
1, 2	1	2	2	IN	Supply Input.
7	2, TAB	5, 6, 7, 8	3, TAB	GND	Ground: SOT-223 Pin 2 and TAB are internally connected. SOIC-8 Pins 5 through 8 are internally connected.
3, 4	3	3	4	OUT	Regulator Output: Pins 3 and 4 must be tied together.
5	—	—	—	NC	Not Connected.
8	—	1	1	EN	Enable (Input): CMOS-compatible control input. Logic-High = Enable; Logic-Low = Shutdown.
—	—	4 (Fixed)	5 (Fixed)	BYP	Reference Bypass: Connect external 470 pF capacitor to GND to reduce output noise. Can be left open. For 1.8V or 2.5V operation, see Application Information.
6	—	4 (Adjustable)	5 (Adjustable)	ADJ	Adjust (Input): Feedback input. Connect to resistive voltage-divider network.
EP	—	—	—	ePad	Exposed Thermal Pad: Connect to GND for best thermal performance.

# MIC5209

## 4.0 APPLICATIONS INFORMATION

### 4.1 Enable/Shutdown

Enable is not available on devices in the SOT-223 (S) package.

Forcing EN (enable/shutdown) high (> 2V) enables the regulator. EN is compatible with CMOS logic. If the enable/shutdown feature is not required, connect EN to IN (supply input).

### 4.2 Input Capacitor

A 1  $\mu$ F capacitor should be placed from IN to GND if there is more than 10 inches of wire between the input and the AC filter capacitor or if a battery is used as the input.

### 4.3 Output Capacitor

An output capacitor is required between OUT and GND to prevent oscillation. The minimum size of the output capacitor is dependent upon whether a reference bypass capacitor is used. 1  $\mu$ F minimum is recommended when  $C_{BYP}$  is not used (see [Figure 4-1](#)). 2.2  $\mu$ F minimum is recommended when  $C_{BYP}$  is 470 pF (see [Figure 4-2](#)). Larger values improve the regulator's transient response.

The output capacitor should have an ESR (equivalent series resistance) of about 1 $\Omega$  and a resonant frequency above 1 MHz. Ultra-low-ESR and ceramic capacitors can cause a low amplitude oscillation on the output and/or underdamped transient response. Most tantalum or aluminum electrolytic capacitors are adequate; film types will work, but are more expensive. Since many aluminum electrolytics have electrolytes that freeze at about  $-30^{\circ}\text{C}$ , solid tantalums are recommended for operation below  $-25^{\circ}\text{C}$ .

At lower values of output current, less output capacitance is needed for output stability. The capacitor can be reduced to 0.47  $\mu$ F for current below 10 mA or 0.33  $\mu$ F for currents below 1 mA.

### 4.4 No-Load Stability

The MIC5209 will remain stable and in regulation with no load (other than the internal voltage divider) unlike many other voltage regulators. This is especially important in CMOSRAM keep-alive applications.

### 4.5 Reference Bypass Capacitor

Reference bypass (BYP) is available only on devices in SOIC-8 and DDPACK packages.

BYP is connected to the internal voltage reference. A 470 pF capacitor ( $C_{BYP}$ ) connected from BYP to GND quiets this reference, providing a significant reduction in output noise (ultra-low-noise performance). Because

$C_{BYP}$  reduces the phase margin, the output capacitor should be increased to at least 2.2  $\mu$ F to maintain stability.

The start-up speed of the MIC5209 is inversely proportional to the size of the reference bypass capacitor. Applications requiring a slow ramp-up of output voltage should consider larger values of  $C_{BYP}$ . Likewise, if rapid turn-on is necessary, consider omitting  $C_{BYP}$ .

If output noise is not a major concern, omit  $C_{BYP}$  and leave BYP open.

### 4.6 Thermal Considerations

The SOT-223 has a ground tab that allows it to dissipate more power than the SOIC-8 (refer to the [Slot-1 Power Supply](#) sub-section for details). At  $+25^{\circ}\text{C}$  ambient, it will operate reliably at 1.6W dissipation with "worst-case" mounting (no ground plane, minimum trace widths, and FR4 printed circuit board).

Thermal resistance values for the SOIC-8 represent typical mounting on a 1"-square, copper-clad, FR4 circuit board. For greater power dissipation, SOIC-8 versions of the MIC5209 feature a fused internal lead frame and die bonding arrangement that reduces thermal resistance when compared to standard SOIC-8 packages.

**TABLE 4-1: MIC5209 THERMAL RESISTANCE**

Package	$\theta_{JA}$	$\theta_{JC}$
SOT-223 (S)	62 $^{\circ}\text{C}/\text{W}$	15 $^{\circ}\text{C}/\text{W}$
SOIC-8 (M)	50 $^{\circ}\text{C}/\text{W}$	25 $^{\circ}\text{C}/\text{W}$
DDPAK (U)	31.4 $^{\circ}\text{C}/\text{W}$	3 $^{\circ}\text{C}/\text{W}$
3x3 VDFN (ML)	64 $^{\circ}\text{C}/\text{W}$	12 $^{\circ}\text{C}/\text{W}$

Multilayer boards with a ground plane, wide traces near the pads, and large supply-bus lines will have better thermal conductivity and will also allow additional power dissipation.

For additional heat sink characteristics, refer to [Application Hint 17](#). For a full discussion of heat sinking and thermal effects on voltage regulators, refer to the "Regulator Thermals" section of the [Designing with Low-Dropout Voltage Regulators](#) handbook.

### 4.7 Low-Voltage Operation

The MIC5209-1.8 and MIC5209-2.5 require special consideration when used in voltage-sensitive systems. They may momentarily overshoot their nominal output voltages unless appropriate output and bypass capacitor values are chosen.

During regulator power up, the pass transistor is fully saturated for a short time, while the error amplifier and voltage reference are being powered up more slowly from the output (see [Functional Diagrams](#)). Selecting

larger output and bypass capacitors allows additional time for the error amplifier and reference to turn on and prevent overshoot.

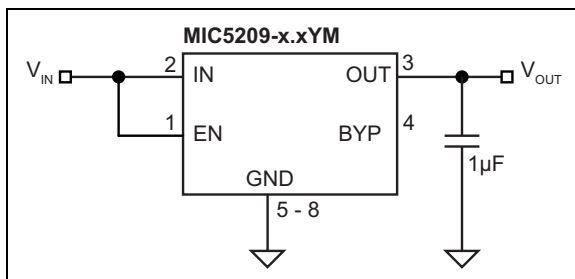
To ensure that no overshoot is present when starting up into a light load (100  $\mu$ A), use a 4.7  $\mu$ F output capacitance and 470 pF bypass capacitance. This slows the turn-on enough to allow the regulator to react and keep the output voltage from exceeding its nominal value. At heavier loads, use a 10  $\mu$ F output capacitance and 470 pF bypass capacitance. Lower values of output and bypass capacitance can be used, depending on the sensitivity of the system.

Applications that can withstand some overshoot on the output of the regulator can reduce the output capacitor and/or reduce or eliminate the bypass capacitor. Applications that are not sensitive to overshoot due to power-on reset delays can use normal output and bypass capacitor configurations.

Please note the junction temperature range of the regulator with an output less than 2.5V (fixed and adjustable) is 0°C to +125°C.

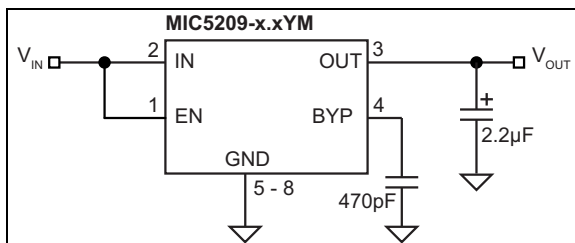
## 4.8 Fixed Regulator Applications

Figure 4-1 shows a basic MIC5209-x.xYM (SOIC-8) fixed-voltage regulator circuit. See Figure 5 for a similar configuration using the more thermally-efficient MIC5209-x.xYS (SOT-223). A 1  $\mu$ F minimum output capacitor is required for basic fixed-voltage applications.



**FIGURE 4-1:** Low-Noise Fixed-Voltage Application.

Figure 4-2 includes the optional 470 pF noise bypass capacitor between BYP and GND to reduce output noise. Note that the minimum value of  $C_{OUT}$  must be increased when the bypass capacitor is used.



**FIGURE 4-2:** Ultra-Low-Noise Fixed-Voltage Application.

## 4.9 Adjustable Regulator Applications

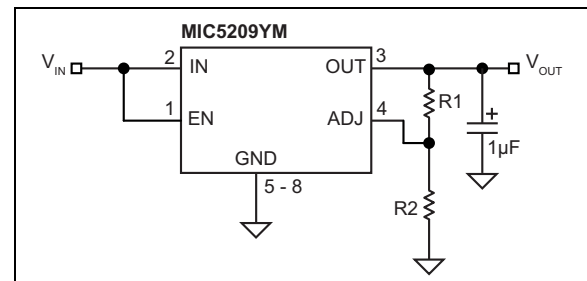
The MIC5209YM, MIC5209YU, and MIC5209YML can be adjusted to a specific output voltage by using two external resistors (Figure 4-3). The resistors set the output voltage based on the equation:

### EQUATION 4-1:

$$V_{OUT} = 1.242V \times \left(1 + \frac{R2}{R1}\right)$$

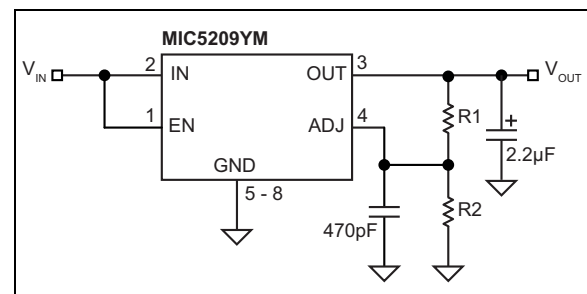
This equation is correct due to the configuration of the bandgap reference. The bandgap voltage is relative to the output, as seen in the Functional Diagrams. Traditional regulators normally have the reference voltage relative to ground; therefore, their equations are different from the equation for the MIC5209Y.

Although ADJ is a high-impedance input and, for best performance, R2 should not exceed 470 k $\Omega$ .



**FIGURE 4-3:** Low-Noise Adjustable-Voltage Application.

Figure 4-4 includes the optional 470 pF bypass capacitor from ADJ to GND to reduce output noise.



**FIGURE 4-4:** Ultra-Low-Noise Adjustable Application.

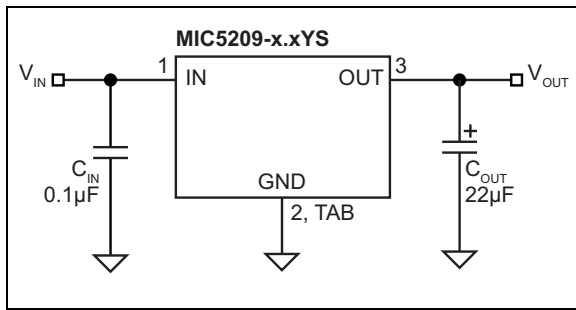
## 4.10 Slot-1 Power Supply

Intel's Pentium II processors have a requirement for a 2.5V  $\pm$ 5% power supply for a clock synthesizer and its associated loads. The current requirement for the 2.5V supply is dependent upon the clock synthesizer used,

# MIC5209

the number of clock outputs, and the type of level shifter (from core logic levels to 2.5V levels). Intel estimates a “worst-case” load of 320 mA.

The MIC5209 was designed to provide the 2.5V power requirement for Slot-1 applications. Its guaranteed performance of 2.5V ±3% at 500 mA allows adequate margin for all systems, and the dropout voltage of 500 mV means that it operates from a “worst-case” 3.3V supply where the voltage can be as low as 3.0V.



**FIGURE 4-5:** Slot-1 Power Supply.

A Slot-1 power supply (Figure 4-5) is easy to implement. Only two capacitors are necessary, and their values are not critical.  $C_{IN}$  bypasses the internal circuitry and should be at least 0.1 µF.  $C_{OUT}$  provides output filtering, improves transient response, and compensates the internal regulator control loop. Its value should be at least 22 µF.  $C_{IN}$  and  $C_{OUT}$  can be increased as much as desired.

#### 4.10.1 SLOT-1 POWER SUPPLY POWER DISSIPATION

Powered from a 3.3V supply, the Slot-1 power supply illustrated in Figure 4-5 has a nominal efficiency of 75%. At the maximum anticipated Slot-1 load (320 mA), the nominal power dissipation is only 256 mW.

The SOT-223 package has sufficient thermal characteristics for wide design margins when mounted on a single-layer copper-clad printed circuit board. The power dissipation of the MIC5209 is calculated using the voltage drop across the device output current plus supply voltage ground current.

Considering “worst-case” tolerances, the power dissipation could be as high as:

#### EQUATION 4-2:

$$(V_{IN(MAX)} - V_{OUT(MAX)}) \times I_{OUT} + V_{IN(MAX)} \times I_{GND}$$

So:

#### EQUATION 4-3:

$$[(3.6V - 2.375V) \times 320mA] + (3.6V \times 4mA)$$

Resulting in:

#### EQUATION 4-4:

$$P_D = 407mW$$

Using the maximum junction temperature of +125°C and a  $\theta_{JC}$  of 15°C/W for the SOT-223, 25°C/W for the SOIC-8, or 3°C/W for the DDPK package, the following worst-case heat-sink thermal resistance ( $\theta_{SA}$ ) requirements are:

#### EQUATION 4-5:

$$\theta_{JA} = \frac{T_{J(MAX)} - T_A}{P_D}$$

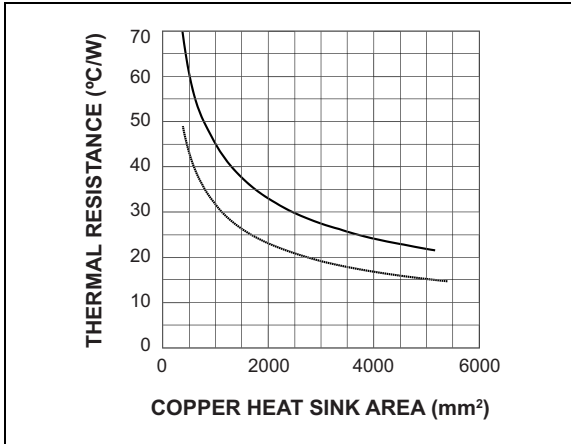
Where:  $\theta_{SA} = \theta_{JA} - \theta_{JC}$

Table 4-2 and Figure 4-6 show that the Slot-1 power supply application can be implemented with a minimum footprint layout.

**TABLE 4-2: MAXIMUM ALLOWABLE THERMAL RESISTANCE**

$T_A$	+40°C	+50°C	+60°C	+70°C
$\theta_{JA}$ Limit	209°C/W	184°C/W	160°C/W	135°C/W
$\theta_{SA}$ SOT-223	194°C/W	169°C/W	145°C/W	120°C/W
$\theta_{SA}$ SOIC-8	184°C/W	159°C/W	135°C/W	110°C/W
$\theta_{SA}$ DDPK	206°C/W	181°C/W	157°C/W	132°C/W

Figure 4-6 shows the necessary copper pad area to obtain specific heatsink thermal resistance ( $\theta_{SA}$ ) values. The  $\theta_{SA}$  values highlighted in Table 4-2 require much less than 500 mm<sup>2</sup> of copper and, per Figure 4-6, can be easily accomplished with the minimum footprint.















**FIGURE 4-6:** PCB Heatsink Thermal Resistance.

# MIC5209

## 5.0 PACKAGING INFORMATION

### 5.1 Package Marking Information

5-Pin SOT-223*	Example	8-Pin VDFN*	Example
 XXXX XXXXNNNP	 5209 25YS722P	 Y XXXX NNN	 Y 5209 916
SOIC-8 (Fixed)*	Example	5-Pin DDPACK (Fixed)*	Example
 XXXX -X.XXX WNNN	 5209 -3.3YM 9651	 XXXX -X.XXX WNNNP	 5209 -3.3YU 5492P
SOIC-8 (Adj.)*	Example	5-Pin DDPACK (Adj)*	Example
 XXX XXXXXX WNNN	 MIC 5209YM 1312	 XXX XXXXXX WNNNP	 MIC 5209YU 1975P

<b>Legend:</b>	XX...X	Product code or customer-specific information
	Y	Year code (last digit of calendar year)
	YY	Year code (last 2 digits of calendar year)
	WW	Week code (week of January 1 is week '01')
	NNN	Alphanumeric traceability code
	(e3)	Pb-free JEDEC® designator for Matte Tin (Sn)
	*	This package is Pb-free. The Pb-free JEDEC designator (e3) can be found on the outer packaging for this package.
	●, ▲, ▼	Pin one index is identified by a dot, delta up, or delta down (triangle mark).
<b>Note:</b>	In the event the full Microchip part number cannot be marked on one line, it will be carried over to the next line, thus limiting the number of available characters for customer-specific information. Package may or may not include the corporate logo.	
	Underbar ( ) and/or Overbar ( ) symbol may not be to scale.	

**Note:** If the full seven-character YYWWNNN code cannot fit on the package, the following truncated codes are used based on the available marking space:  
 6 Characters = YWWNNN; 5 Characters = WWNNN; 4 Characters = WNNN; 3 Characters = NNN;  
 2 Characters = NN; 1 Character = N

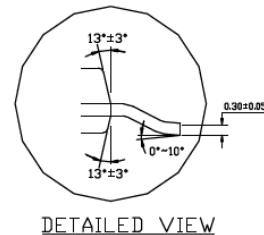
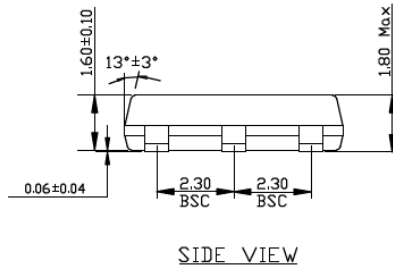
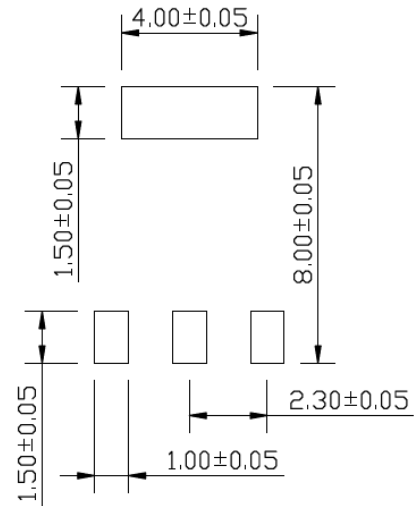
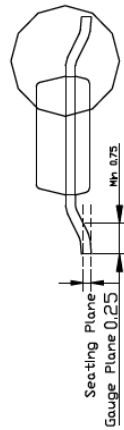
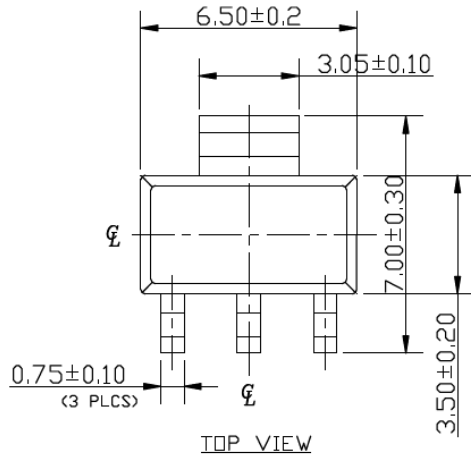


## 3-Lead SOT-223 Package Outline and Recommended Land Pattern

**TITLE**

3 LEAD SOT223 PACKAGE OUTLINE & RECOMMENDED LAND PATTERN

DRAWING #	SOT223-3LD-PL-1	UNIT	MM
-----------	-----------------	------	----



**NOTE:**

1. Dimensions and tolerances are as per ANSI Y14.5M, 1982.
2. Controlling dimension: Millimeters.
3. Dimensions are exclusive of mold flash and gate burr.
4. All specification comply to Jedec spec T0261 Issue C.

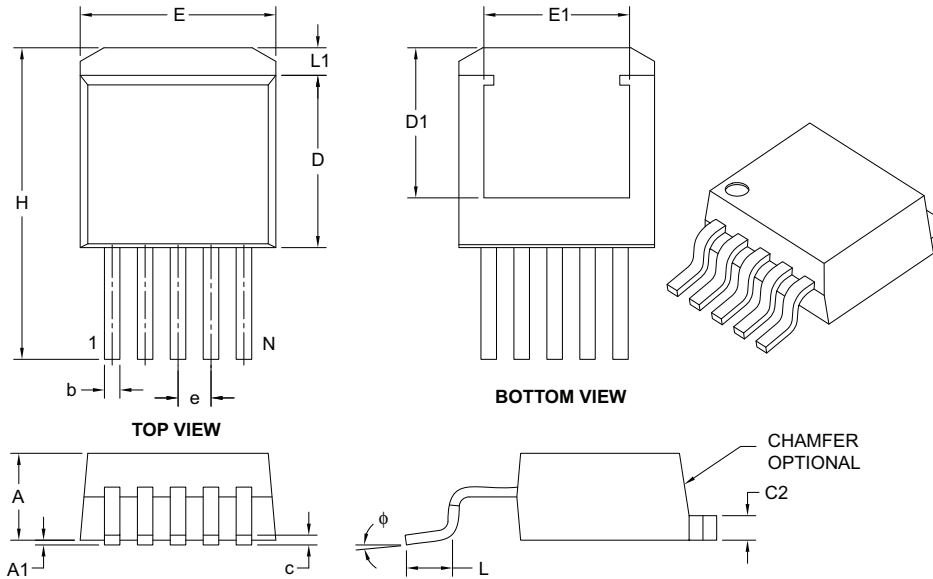
Note: For the most current package drawings, please see the Microchip Packaging Specification located at <http://www.microchip.com/packaging>.

# MIC5209

## 5-Lead DDPAK Package Outline and Recommended Land Pattern

### 5-Lead Plastic (ET) [DDPAK]

**Note:** For the most current package drawings, please see the Microchip Packaging Specification located at <http://www.microchip.com/packaging>



Dimension Limits	Units	INCHES		
		MIN	NOM	MAX
Number of Pins	N	5		
Pitch	e	.067 BSC		
Overall Height	A	.160	–	.190
Standoff §	A1	.000	–	.010
Overall Width	E	.380	–	.420
Exposed Pad Width	E1	.245	–	–
Molded Package Length	D	.330	–	.380
Overall Length	H	.549	–	.625
Exposed Pad Length	D1	.270	–	–
Lead Thickness	c	.014	–	.029
Pad Thickness	C2	.045	–	.065
Lead Width	b	.020	–	.039
Foot Length	L	.068	–	.110
Pad Length	L1	–	–	.067
Foot Angle	φ	0°	–	8°

**Notes:**

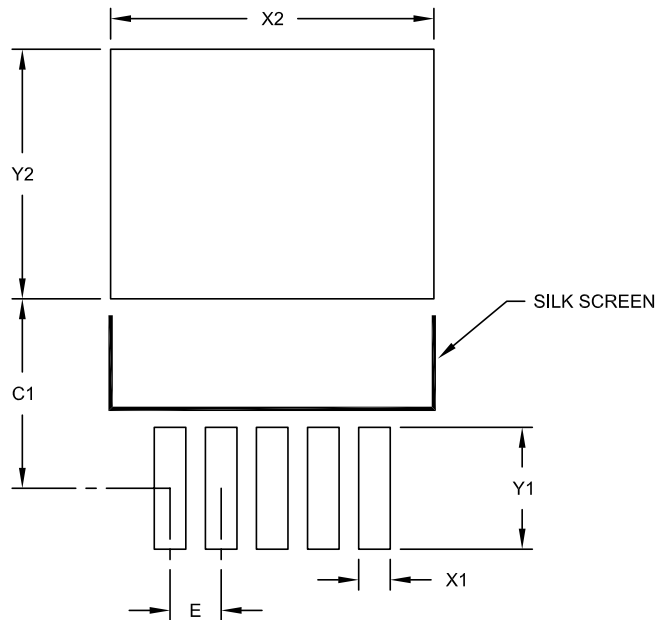
- § Significant Characteristic.
- Dimensions D and E do not include mold flash or protrusions. Mold flash or protrusions shall not exceed .005" per side.
- Dimensioning and tolerancing per ASME Y14.5M.

BSC: Basic Dimension. Theoretically exact value shown without tolerances.

Microchip Technology Drawing C04-012B

## 5-Lead Plastic (ET) [DDPAK]

**Note:** For the most current package drawings, please see the Microchip Packaging Specification located at <http://www.microchip.com/packaging>



RECOMMENDED LAND PATTERN

Dimension Limits	Units	INCHES		
		MIN	NOM	MAX
Contact Pitch	E	.067 BSC		
Optional Center Pad Width	X2			.423
Optional Center Pad Length	Y2			.327
Contact Pad Spacing	C1		.248	
Contact Pad Width (X5)	X1			.041
Contact Pad Length (X5)	Y1			.159

Notes:

1. Dimensioning and tolerancing per ASME Y14.5M

BSC: Basic Dimension. Theoretically exact value shown without tolerances.

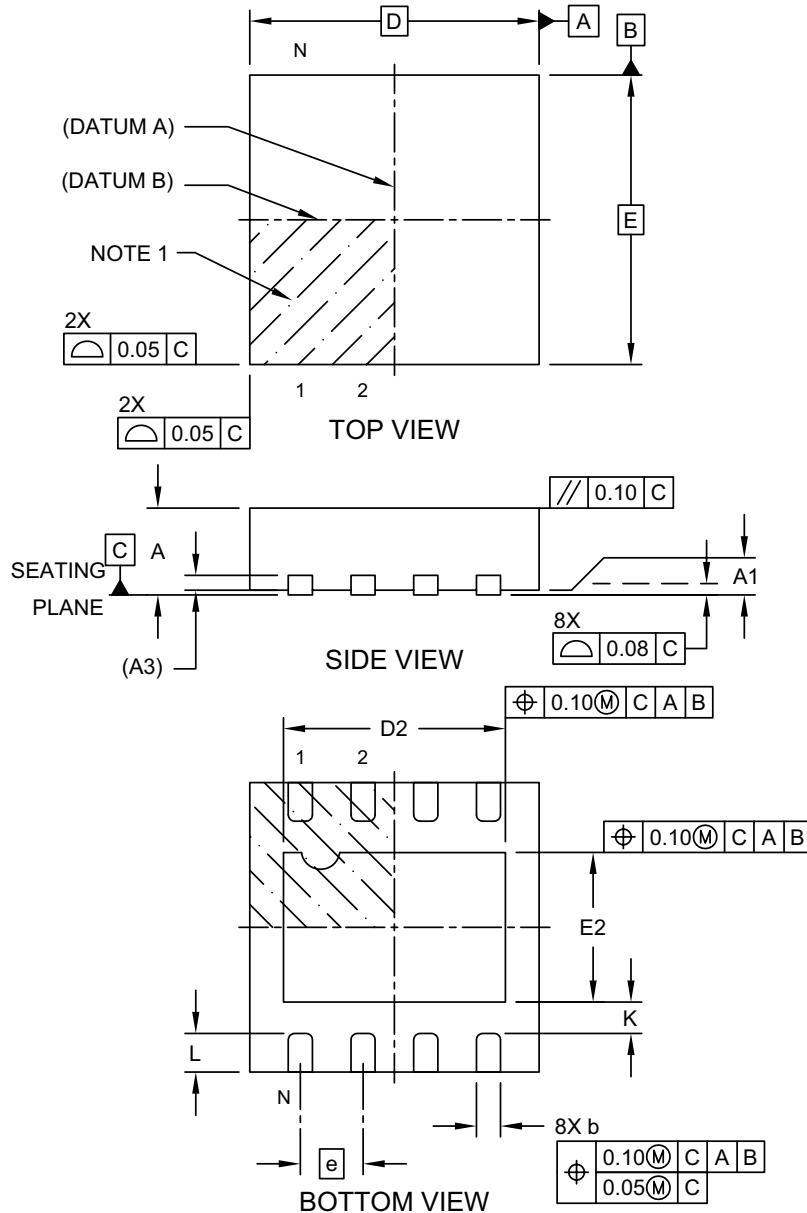
Microchip Technology Drawing No. C04-2012A

# MIC5209

## 8-Lead 3 mm x 3 mm VDFN Package Outline and Recommended Land Pattern

### 8-Lead Very Thin Plastic Dual Flat, No Lead Package (JMA) - 3x3x0.9 mm Body [VDFN] Micrel Legacy Package DFN33-8LD-PL-1

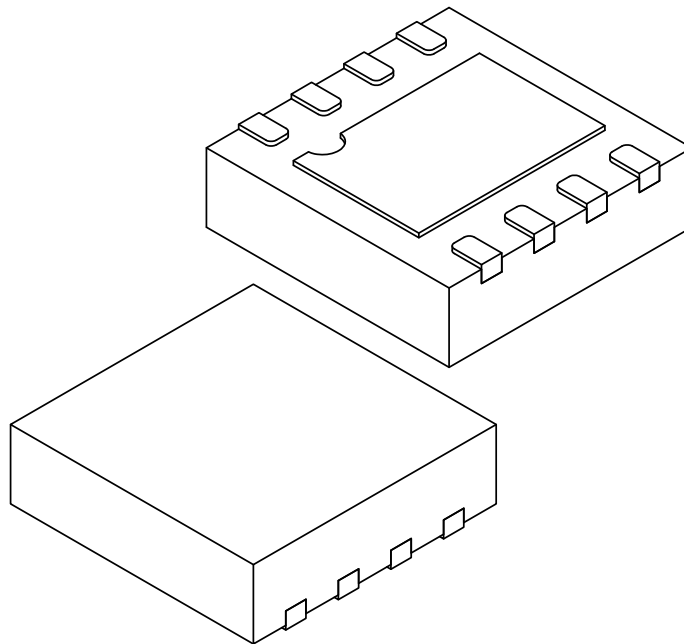
**Note:** For the most current package drawings, please see the Microchip Packaging Specification located at <http://www.microchip.com/packaging>



Microchip Technology Drawing C04-1021 A Sheet 1 of 2

## 8-Lead Very Thin Plastic Dual Flat, No Lead Package (JMA) - 3x3x0.9 mm Body [VDFN] Micrel Legacy Package DFN33-8LD-PL-1

**Note:** For the most current package drawings, please see the Microchip Packaging Specification located at <http://www.microchip.com/packageing>



Dimension Limits	Units	MILLIMETERS		
		MIN	NOM	MAX
Number of Terminals	N	8		
Pitch	e	0.65 BSC		
Overall Height	A	0.80	0.85	0.90
Standoff	A1	0.00	0.02	0.05
Terminal Thickness	A3	0.203 REF		
Overall Length	D	3.00 BSC		
Exposed Pad Length	D2	2.25	2.30	2.35
Overall Width	E	3.00 BSC		
Exposed Pad Width	E2	1.50	1.55	1.60
Terminal Width	b	0.20	0.25	0.30
Terminal Length	L	0.35	0.40	0.45
Terminal-to-Exposed-Pad	K	0.20	-	-

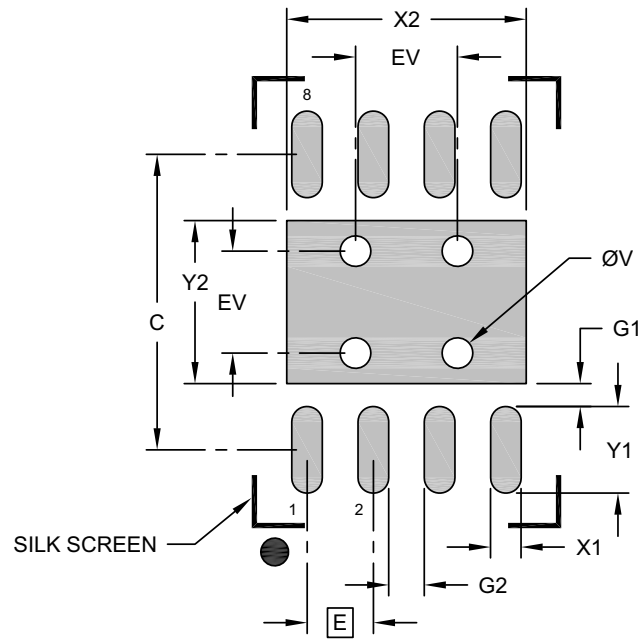
**Notes:**

- Pin 1 visual index feature may vary, but must be located within the hatched area.
- Package is saw singulated
- Dimensioning and tolerancing per ASME Y14.5M
  - BSC: Basic Dimension. Theoretically exact value shown without tolerances.
  - REF: Reference Dimension, usually without tolerance, for information purposes only.

Microchip Technology Drawing C04-1021 A Sheet 1 of 2

## 8-Lead Very Thin Plastic Dual Flat, No Lead Package (JMA) - 3x3x0.9 mm Body [VDFN] Micrel Legacy Package DFN33-8LD-PL-1

**Note:** For the most current package drawings, please see the Microchip Packaging Specification located at <http://www.microchip.com/packaging>



### RECOMMENDED LAND PATTERN

Dimension Limits	Units	MILLIMETERS		
		MIN	NOM	MAX
Contact Pitch	E	0.65 BSC		
Optional Center Pad Width	X2			2.35
Optional Center Pad Length	Y2			1.60
Contact Pad Spacing	C		2.90	
Contact Pad Width (X8)	X1			0.30
Contact Pad Length (X8)	Y1			0.85
Contact Pad to Center Pad (X8)	G1	0.23		
Contact Pad to Contact Pad (X6)	G2	0.35		
Thermal Via Diameter	V		0.30	
Thermal Via Pitch	EV		1.00	

**Notes:**

- Dimensioning and tolerancing per ASME Y14.5M  
BSC: Basic Dimension. Theoretically exact value shown without tolerances.
- For best soldering results, thermal vias, if used, should be filled or tented to avoid solder loss during reflow process

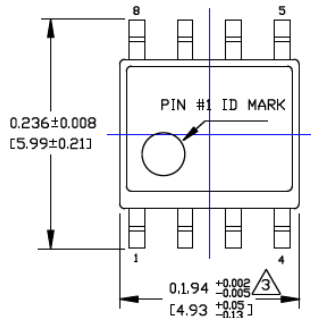
Microchip Technology Drawing C04-3021 Rev A

## 8-Lead SOIC Package Outline and Recommended Land Pattern

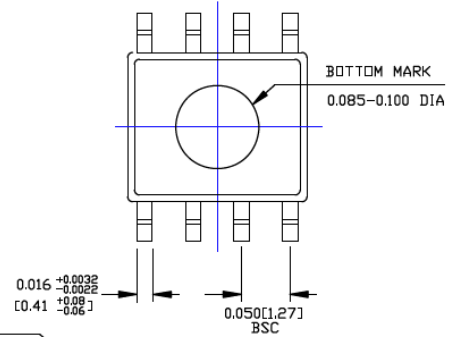
**TITLE**

8 LEAD SOICN PACKAGE OUTLINE & RECOMMENDED LAND PATTERN

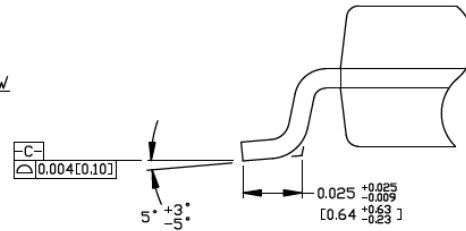
DRAWING #	SOICN-8LD-PL-1	UNIT	INCH [MM]
-----------	----------------	------	-----------



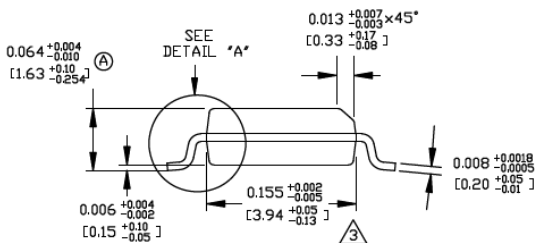
TOP VIEW



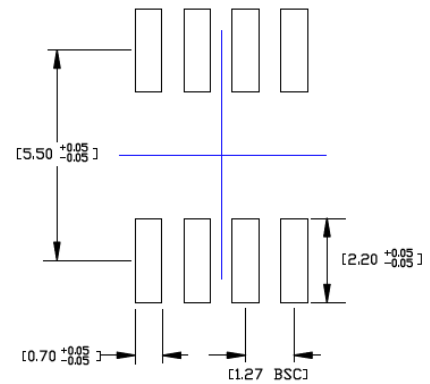
BOTTOM VIEW



DETAIL "A"



END VIEW



RECOMMENDED LAND PATTERN

**NOTES:**

1. DIMENSIONS ARE IN INCHES[MM].
2. CONTROLLING DIMENSION: INCHES.
3. DIMENSION DOES NOT INCLUDE MOLD FLASH OR PROTRUSIONS, EITHER OF WHICH SHALL NOT EXCEED 0.010[0.25] PER SIDE.

Note: For the most current package drawings, please see the Microchip Packaging Specification located at <http://www.microchip.com/packaging>.

# MIC5209

---

---

NOTES:



## APPENDIX A: REVISION HISTORY

### Revision A (February 2017)

- Converted Micrel document MIC5209 to Microchip data sheet DS20005720A.
- Minor text changes throughout.
- Updated TO-263-5 packaging spec to DDPAK.
- Updated Thermal Resistance values to be current with Microchip packaging.

### Revision B (January 2022)

- Updated [Package Marking Information](#) drawing.
- Updated [8-Lead 3 mm x 3 mm VDFN Package Outline and Recommended Land Pattern](#) drawing.
- Updated all instances of DFN in text/graphics to VDFN.

# MIC5209

---

---

NOTES:

## PRODUCT IDENTIFICATION SYSTEM

To order or obtain information, e.g., on pricing or delivery, contact your local Microchip representative or sales office.

<u>PART NO.</u>	-	<u>XX</u>	<u>X</u>	<u>X</u>	-	<u>XX</u>
Device		Voltage	Temperature	Package		Media Type
<b>Device:</b>	MIC5209:	500 mA Low Noise LDO Regulator				
<b>Voltage:</b>	(blank) =	Adjustable				
	1.8 =	1.8V				
	2.5 =	2.5V				
	3.0 =	3.0V				
	3.3 =	3.3V				
	3.6 =	3.6V				
	4.2 =	4.2V				
	5.0 =	5.0V				
<b>Temperature:</b>	Y =	-40°C to +125°C				
<b>Package:</b>	M =	8-Lead SOIC				
	ML =	8-Lead VDFN				
	S =	3-Lead SOT-223				
	U =	5-Lead DDPAK				
<b>Media Type:</b>	TR =	2,500/Reel (SOIC, SOT-223)				
	TR =	750/Reel (DDPAK)				
	TR =	5,000/Reel (VDFN)				
	T5 =	500/Reel (VDFN)				
	(blank)=	50/Tube (DDPAK)				
	(blank)=	78/Tube (SOT-223)				
	(blank)=	95/Tube (SOIC)				
<b>Examples:</b>						
a)	MIC5209-1.8YM-TR:	500 mA Low-Noise LDO Regulator, 1.8V Voltage, -40°C to +125°C Temp. Range, 8-Lead SOIC, 2,500/Reel				
b)	MIC5209-1.8YM:	500 mA Low-Noise LDO Regulator, 1.8V Voltage, -40°C to +125°C Temp. Range, 8-Lead SOIC, 95/Tube				
c)	MIC5209-2.5YU-TR:	500 mA Low-Noise LDO Regulator, 2.5V Voltage, -40°C to +125°C Temp. Range, 5-Lead DDPAK, 750/Reel				
d)	MIC5209-2.5YU:	500 mA Low-Noise LDO Regulator, 2.5V Voltage, -40°C to +125°C Temp. Range, 5-Lead DDPAK, 50/Tube				
e)	MIC5209-3.0YS-TR:	500 mA Low-Noise LDO Regulator, 3.0V Voltage, -40°C to +125°C Temp. Range, 3-Lead SOT-223, 2,500/Reel				
f)	MIC5209-3.0YS:	500 mA Low-Noise LDO Regulator, 3.0V Voltage, -40°C to +125°C Temp. Range, 3-Lead SOT-223, 78/Tube				
g)	MIC5209YML-TR:	500 mA Low-Noise LDO Regulator, Adj. Voltage, -40°C to +125°C Temp. Range, 8-Lead VDFN, 5,000/Reel				
h)	MIC5209YML-T5:	500 mA Low-Noise LDO Regulator, Adj. Voltage, -40°C to +125°C Temp. Range, 8-Lead VDFN, 500/Reel				
<b>Note 1:</b> Tape and Reel identifier only appears in the catalog part number description. This identifier is used for ordering purposes and is not printed on the device package. Check with your Microchip Sales Office for package availability with the Tape and Reel option.						

# MIC5209

---

---

NOTES:

---

---

**Note the following details of the code protection feature on Microchip products:**

- Microchip products meet the specifications contained in their particular Microchip Data Sheet.
- Microchip believes that its family of products is secure when used in the intended manner, within operating specifications, and under normal conditions.
- Microchip values and aggressively protects its intellectual property rights. Attempts to breach the code protection features of Microchip product is strictly prohibited and may violate the Digital Millennium Copyright Act.
- Neither Microchip nor any other semiconductor manufacturer can guarantee the security of its code. Code protection does not mean that we are guaranteeing the product is “unbreakable”. Code protection is constantly evolving. Microchip is committed to continuously improving the code protection features of our products.

---

This publication and the information herein may be used only with Microchip products, including to design, test, and integrate Microchip products with your application. Use of this information in any other manner violates these terms. Information regarding device applications is provided only for your convenience and may be superseded by updates. It is your responsibility to ensure that your application meets with your specifications. Contact your local Microchip sales office for additional support or, obtain additional support at <https://www.microchip.com/en-us/support/design-help/client-support-services>.

THIS INFORMATION IS PROVIDED BY MICROCHIP "AS IS". MICROCHIP MAKES NO REPRESENTATIONS OR WARRANTIES OF ANY KIND WHETHER EXPRESS OR IMPLIED, WRITTEN OR ORAL, STATUTORY OR OTHERWISE, RELATED TO THE INFORMATION INCLUDING BUT NOT LIMITED TO ANY IMPLIED WARRANTIES OF NON-INFRINGEMENT, MERCHANTABILITY, AND FITNESS FOR A PARTICULAR PURPOSE, OR WARRANTIES RELATED TO ITS CONDITION, QUALITY, OR PERFORMANCE.

IN NO EVENT WILL MICROCHIP BE LIABLE FOR ANY INDIRECT, SPECIAL, PUNITIVE, INCIDENTAL, OR CONSEQUENTIAL LOSS, DAMAGE, COST, OR EXPENSE OF ANY KIND WHATSOEVER RELATED TO THE INFORMATION OR ITS USE, HOWEVER CAUSED, EVEN IF MICROCHIP HAS BEEN ADVISED OF THE POSSIBILITY OR THE DAMAGES ARE FORESEEABLE. TO THE FULLEST EXTENT ALLOWED BY LAW, MICROCHIP'S TOTAL LIABILITY ON ALL CLAIMS IN ANY WAY RELATED TO THE INFORMATION OR ITS USE WILL NOT EXCEED THE AMOUNT OF FEES, IF ANY, THAT YOU HAVE PAID DIRECTLY TO MICROCHIP FOR THE INFORMATION.

Use of Microchip devices in life support and/or safety applications is entirely at the buyer's risk, and the buyer agrees to defend, indemnify and hold harmless Microchip from any and all damages, claims, suits, or expenses resulting from such use. No licenses are conveyed, implicitly or otherwise, under any Microchip intellectual property rights unless otherwise stated.

For information regarding Microchip's Quality Management Systems, please visit [www.microchip.com/quality](http://www.microchip.com/quality).

**Trademarks**

The Microchip name and logo, the Microchip logo, Adaptec, AnyRate, AVR, AVR logo, AVR Freaks, BesTime, BitCloud, CryptoMemory, CryptoRF, dsPIC, flexPWR, HELDO, IGLOO, JukeBlox, KeeLoq, Kleer, LANCheck, LinkMD, maXStylus, maXTouch, MediaLB, megaAVR, Microsemi, Microsemi logo, MOST, MOST logo, MPLAB, OptoLyzer, PIC, picoPower, PICSTART, PIC32 logo, PolarFire, Prochip Designer, QTouch, SAM-BA, SenGenuity, SpyNIC, SST, SST Logo, SuperFlash, Symmetricom, SyncServer, Tachyon, TimeSource, tinyAVR, UNI/O, Vectron, and XMEGA are registered trademarks of Microchip Technology Incorporated in the U.S.A. and other countries.

AgileSwitch, APT, ClockWorks, The Embedded Control Solutions Company, EtherSynch, Flashtec, Hyper Speed Control, HyperLight Load, IntelliMOS, Libero, motorBench, mTouch, Powermite 3, Precision Edge, ProASIC, ProASIC Plus, ProASIC Plus logo, QuietWire, SmartFusion, SyncWorld, Temux, TimeCesium, TimeHub, TimePictra, TimeProvider, TrueTime, WinPath, and ZL are registered trademarks of Microchip Technology Incorporated in the U.S.A.

Adjacent Key Suppression, AKS, Analog-for-the-Digital Age, Any Capacitor, AnyIn, AnyOut, Augmented Switching, BlueSky, BodyCom, CodeGuard, CryptoAuthentication, CryptoAutomotive, CryptoCompanion, CryptoController, dsPICDEM, dsPICDEM.net, Dynamic Average Matching, DAM, ECAN, Espresso T1S, EtherGREEN, GridTime, IdealBridge, In-Circuit Serial Programming, ICSP, INICnet, Intelligent Paralleling, Inter-Chip Connectivity, JitterBlocker, Knob-on-Display, maxCrypto, maxView, memBrain, Mindi, MiWi, MPASM, MPF, MPLAB Certified logo, MPLIB, MPLINK, MultiTRAK, NetDetach, NVM Express, NVMe, Omniscient Code Generation, PICDEM, PICDEM.net, PICkit, PICtail, PowerSmart, PureSilicon, QMatrix, REAL ICE, Ripple Blocker, RTAX, RTG4, SAM-ICE, Serial Quad I/O, simpleMAP, SimpliPHY, SmartBuffer, SmartHLS, SMART-I.S., storClad, SQL, SuperSwitcher, SuperSwitcher II, Switchtec, SynchroPHY, Total Endurance, TSHARC, USBCheck, VariSense, VectorBlox, VeriPHY, ViewSpan, WiperLock, XpressConnect, and ZENA are trademarks of Microchip Technology Incorporated in the U.S.A. and other countries.

SQTP is a service mark of Microchip Technology Incorporated in the U.S.A.

The Adaptec logo, Frequency on Demand, Silicon Storage Technology, Symmcom, and Trusted Time are registered trademarks of Microchip Technology Inc. in other countries.

GestIC is a registered trademark of Microchip Technology Germany II GmbH & Co. KG, a subsidiary of Microchip Technology Inc., in other countries.

All other trademarks mentioned herein are property of their respective companies.

© 2017 - 2022, Microchip Technology Incorporated and its subsidiaries.

All Rights Reserved.

ISBN: 978-1-5224-9710-3



# MICROCHIP

## Worldwide Sales and Service

### AMERICAS

**Corporate Office**  
2355 West Chandler Blvd.  
Chandler, AZ 85224-6199  
Tel: 480-792-7200  
Fax: 480-792-7277  
Technical Support:  
<http://www.microchip.com/support>  
Web Address:  
[www.microchip.com](http://www.microchip.com)

**Atlanta**  
Duluth, GA  
Tel: 678-957-9614  
Fax: 678-957-1455

**Austin, TX**  
Tel: 512-257-3370

**Boston**  
Westborough, MA  
Tel: 774-760-0087  
Fax: 774-760-0088

**Chicago**  
Itasca, IL  
Tel: 630-285-0071  
Fax: 630-285-0075

**Dallas**  
Addison, TX  
Tel: 972-818-7423  
Fax: 972-818-2924

**Detroit**  
Novi, MI  
Tel: 248-848-4000

**Houston, TX**  
Tel: 281-894-5983

**Indianapolis**  
Noblesville, IN  
Tel: 317-773-8323  
Fax: 317-773-5453  
Tel: 317-536-2380

**Los Angeles**  
Mission Viejo, CA  
Tel: 949-462-9523  
Fax: 949-462-9608  
Tel: 951-273-7800

**Raleigh, NC**  
Tel: 919-844-7510

**New York, NY**  
Tel: 631-435-6000

**San Jose, CA**  
Tel: 408-735-9110  
Tel: 408-436-4270

**Canada - Toronto**  
Tel: 905-695-1980  
Fax: 905-695-2078

### ASIA/PACIFIC

**Australia - Sydney**  
Tel: 61-2-9868-6733

**China - Beijing**  
Tel: 86-10-8569-7000

**China - Chengdu**  
Tel: 86-28-8665-5511

**China - Chongqing**  
Tel: 86-23-8980-9588

**China - Dongguan**  
Tel: 86-769-8702-9880

**China - Guangzhou**  
Tel: 86-20-8755-8029

**China - Hangzhou**  
Tel: 86-571-8792-8115

**China - Hong Kong SAR**  
Tel: 852-2943-5100

**China - Nanjing**  
Tel: 86-25-8473-2460

**China - Qingdao**  
Tel: 86-532-8502-7355

**China - Shanghai**  
Tel: 86-21-3326-8000

**China - Shenyang**  
Tel: 86-24-2334-2829

**China - Shenzhen**  
Tel: 86-755-8864-2200

**China - Suzhou**  
Tel: 86-186-6233-1526

**China - Wuhan**  
Tel: 86-27-5980-5300

**China - Xian**  
Tel: 86-29-8833-7252

**China - Xiamen**  
Tel: 86-592-2388138

**China - Zhuhai**  
Tel: 86-756-3210040

### ASIA/PACIFIC

**India - Bangalore**  
Tel: 91-80-3090-4444

**India - New Delhi**  
Tel: 91-11-4160-8631

**India - Pune**  
Tel: 91-20-4121-0141

**Japan - Osaka**  
Tel: 81-6-6152-7160

**Japan - Tokyo**  
Tel: 81-3-6880-3770

**Korea - Daegu**  
Tel: 82-53-744-4301

**Korea - Seoul**  
Tel: 82-2-554-7200

**Malaysia - Kuala Lumpur**  
Tel: 60-3-7651-7906

**Malaysia - Penang**  
Tel: 60-4-227-8870

**Philippines - Manila**  
Tel: 63-2-634-9065

**Singapore**  
Tel: 65-6334-8870

**Taiwan - Hsin Chu**  
Tel: 886-3-577-8366

**Taiwan - Kaohsiung**  
Tel: 886-7-213-7830

**Taiwan - Taipei**  
Tel: 886-2-2508-8600

**Thailand - Bangkok**  
Tel: 66-2-694-1351

**Vietnam - Ho Chi Minh**  
Tel: 84-28-5448-2100

### EUROPE

**Austria - Wels**  
Tel: 43-7242-2244-39  
Fax: 43-7242-2244-393

**Denmark - Copenhagen**  
Tel: 45-4485-5910  
Fax: 45-4485-2829

**Finland - Espoo**  
Tel: 358-9-4520-820

**France - Paris**  
Tel: 33-1-69-53-63-20  
Fax: 33-1-69-30-90-79

**Germany - Garching**  
Tel: 49-8931-9700

**Germany - Haan**  
Tel: 49-2129-3766400

**Germany - Heilbronn**  
Tel: 49-7131-72400

**Germany - Karlsruhe**  
Tel: 49-721-625370

**Germany - Munich**  
Tel: 49-89-627-144-0  
Fax: 49-89-627-144-44

**Germany - Rosenheim**  
Tel: 49-8031-354-560

**Israel - Ra'anana**  
Tel: 972-9-744-7705

**Italy - Milan**  
Tel: 39-0331-742611  
Fax: 39-0331-466781

**Italy - Padova**  
Tel: 39-049-7625286

**Netherlands - Drunen**  
Tel: 31-416-690399  
Fax: 31-416-690340

**Norway - Trondheim**  
Tel: 47-7288-4388

**Poland - Warsaw**  
Tel: 48-22-3325737

**Romania - Bucharest**  
Tel: 40-21-407-87-50

**Spain - Madrid**  
Tel: 34-91-708-08-90  
Fax: 34-91-708-08-91

**Sweden - Gothenberg**  
Tel: 46-31-704-60-40

**Sweden - Stockholm**  
Tel: 46-8-5090-4654

**UK - Wokingham**  
Tel: 44-118-921-5800  
Fax: 44-118-921-5820