

## Power Schottky rectifier

### Features

- Negligible switching losses
- Low forward voltage drop for higher efficiency and extended battery life
- Low thermal resistance
- Surface mount miniature package
- Avalanche capability specified

### Description

150 V power Schottky rectifiers are suited for switch mode power supplies on up to 24 V rails and high frequency converters.

Packaged in SMA, SMA low profile, and axial, this device is intended for use in consumer and computer applications like TV, STB, PC and DVD where low drop forward voltage is required to reduce power dissipation.

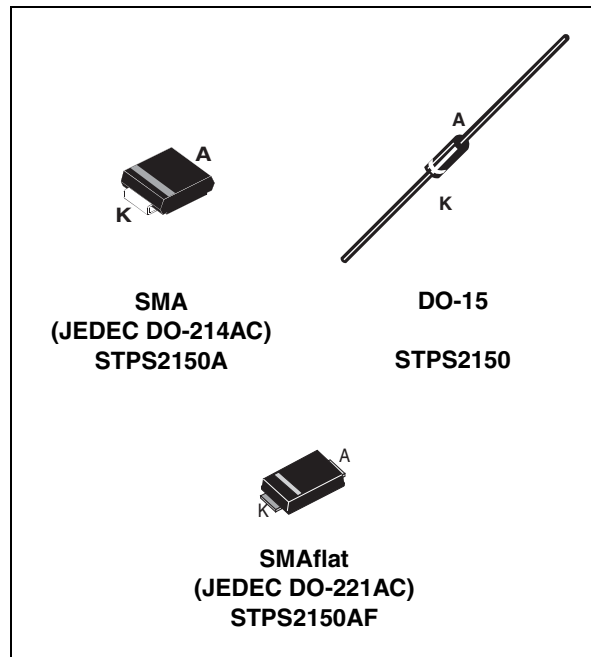

**Table 1. Device summary**

$I_{F(AV)}$	2 A
$V_{RRM}$	150 V
$T_j(\text{max})$	175 °C
$V_F(\text{max})$	0.67 V

# 1 Characteristics

**Table 2. Absolute Ratings (limiting values)**

Symbol	Parameter		Value	Unit	
$V_{RRM}$	Repetitive peak reverse voltage		150	V	
$I_{F(AV)}$	Average forward current	SMA, SMAflat	$T_L = 145\text{ °C}$ $\delta = 0.5$	2	A
		DO-15	$T_L = 130\text{ °C}$ $\delta = 0.5$		
$I_{FSM}$	Surge non repetitive forward current	SMA, SMAflat	$t_p = 10\text{ ms}$ sinusoidal	75	A
		DO-15		150	
$P_{ARM}$	Repetitive peak avalanche power		$t_p = 1\text{ }\mu\text{s}$ $T_j = 25\text{ °C}$	2400	W
$T_{stg}$	Storage temperature range		-65 to + 175	°C	
$T_j$	Maximum operating junction temperature <sup>(1)</sup>		175	°C	

1.  $\frac{dP_{tot}}{dT_j} < \frac{1}{R_{th(j-a)}}$  condition to avoid thermal runaway for a diode on its own heatsink

**Table 3. Thermal resistance**

Symbol	Parameter		Value	Unit
$R_{th(j-l)}$	Junction to lead	SMA, SMAflat	20	°C/W
		Lead length = 10 mm DO-15	30	

**Table 4. Static electrical characteristics**

Symbol	Parameter	Tests conditions		Min.	Typ	Max.	Unit
$I_R$ <sup>(1)</sup>	Reverse leakage current	$T_j = 25\text{ °C}$	$V_R = V_{RRM}$		0.5	1.5	$\mu\text{A}$
		$T_j = 125\text{ °C}$			0.5	1.5	mA
$V_F$ <sup>(2)</sup>	Forward voltage drop	$T_j = 25\text{ °C}$	$I_F = 2\text{ A}$		0.78	0.82	V
		$T_j = 125\text{ °C}$			0.62	0.67	
		$T_j = 25\text{ °C}$	$I_F = 4\text{ A}$		0.86	0.89	
		$T_j = 125\text{ °C}$			0.70	0.75	

1.  $t_p = 5\text{ ms}$ ,  $\delta < 2\%$

2.  $t_p = 380\text{ }\mu\text{s}$ ,  $\delta < 2\%$

To evaluate the conduction losses use the following equation:  $P = 0.59 \times I_{F(AV)} + 0.04 I_{F(RMS)}^2$

**Figure 1. Average forward power dissipation versus average forward current**

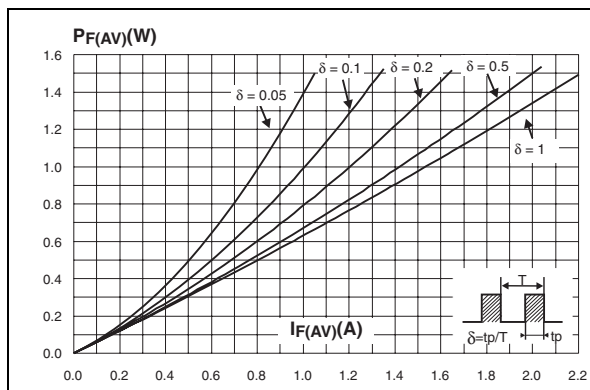

**Figure 2. Average forward current versus ambient temperature (delta = 0.5)**

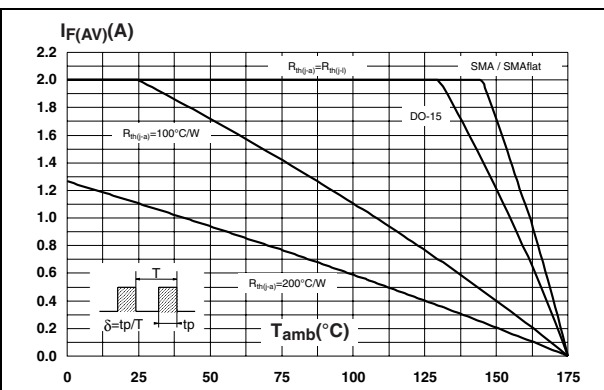

**Figure 3. Normalized avalanche power derating versus pulse duration**

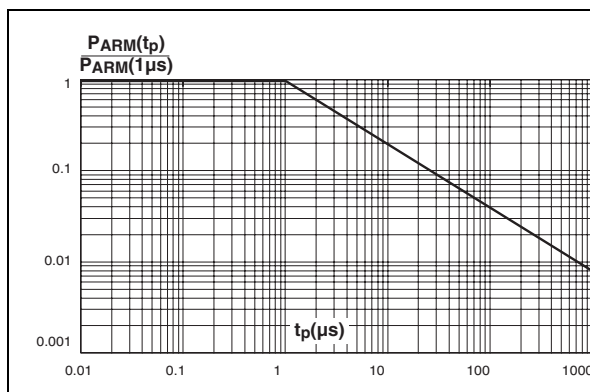

**Figure 4. Normalized avalanche power derating versus junction temperature**

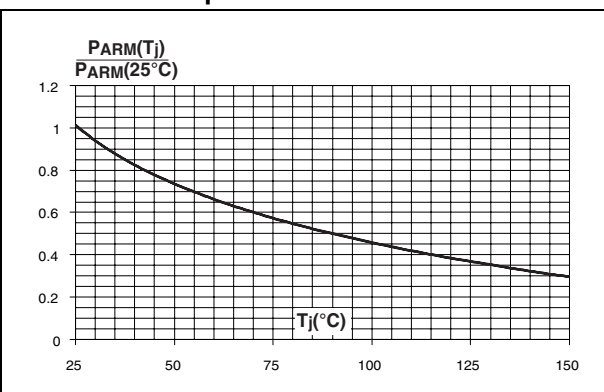

**Figure 5. Non repetitive surge peak forward current versus overload duration (maximum values, DO-15)**

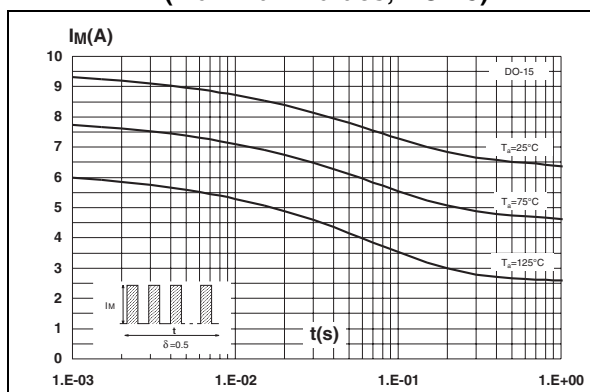

**Figure 6. Non repetitive surge peak forward current versus overload duration (maximum values, SMA)**

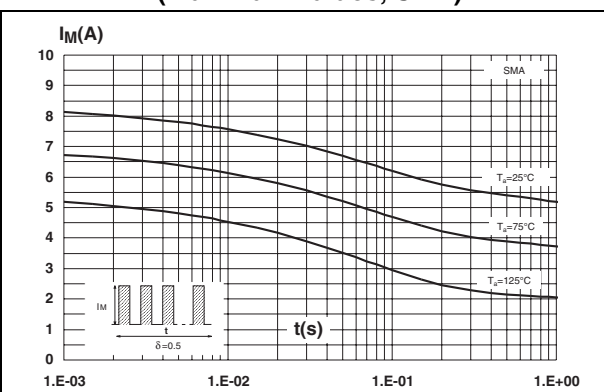

**Figure 7. Non repetitive surge peak forward current versus overload duration (maximum values, SMAflat)**

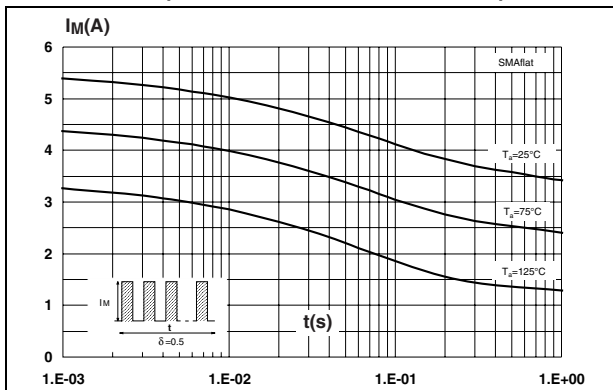

**Figure 8. Relative variation of thermal impedance junction to ambient versus pulse duration (DO-15)**

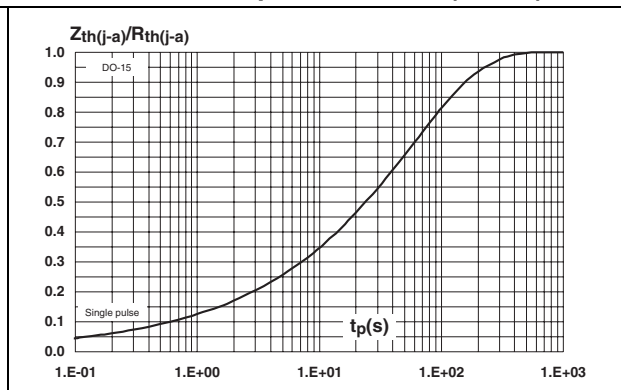

**Figure 9. Relative variation of thermal impedance junction to ambient versus pulse duration (SMA)**

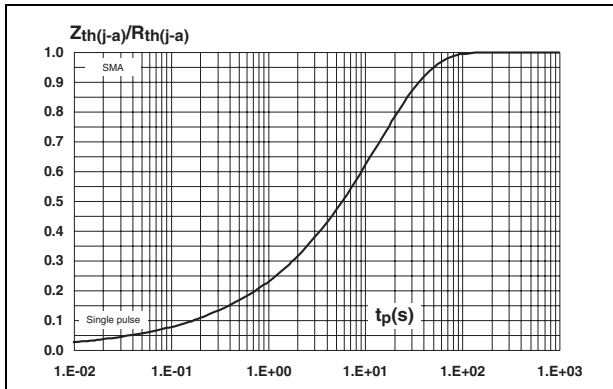

**Figure 10. Relative variation of thermal impedance junction to ambient versus pulse duration (SMAflat)**

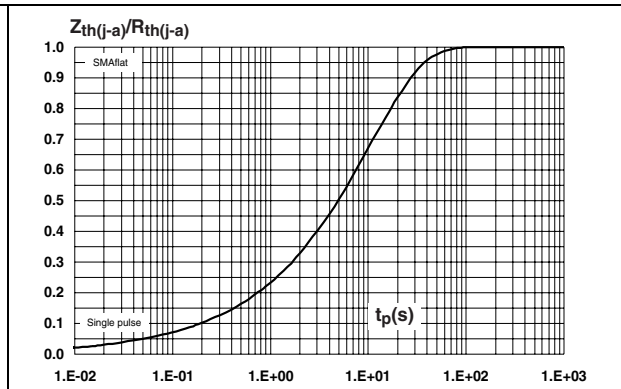

**Figure 11. Reverse leakage current versus reverse voltage applied (typical values)**

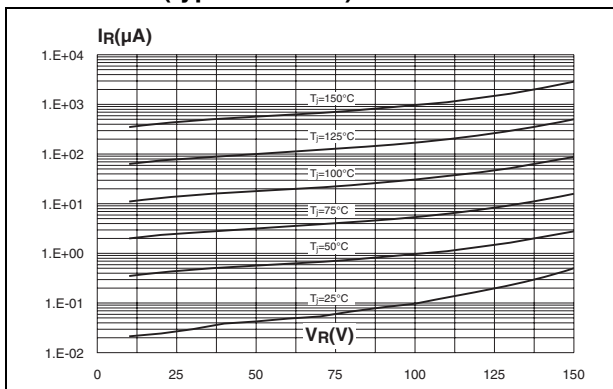

**Figure 12. Junction capacitance versus reverse voltage applied (typical values)**

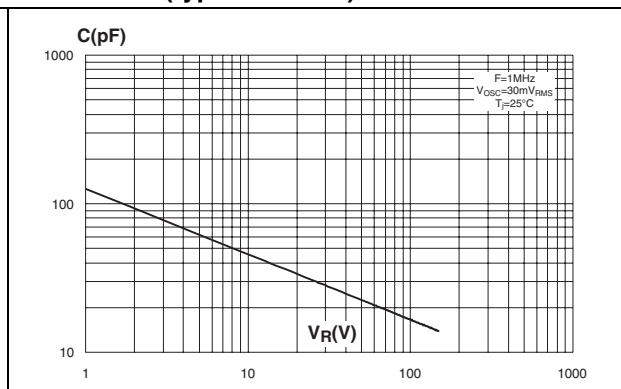

Figure 13. Forward voltage drop versus forward current (maximum values, low level)

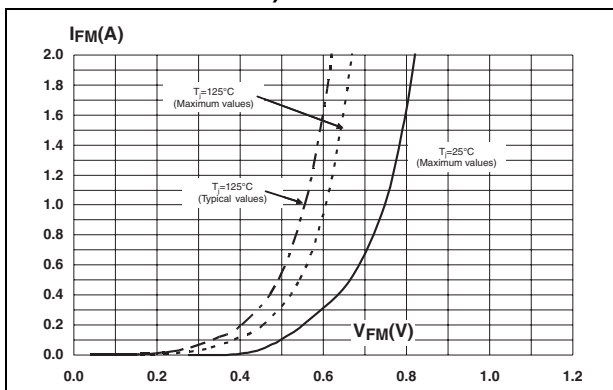

Figure 14. Forward voltage drop versus forward current (maximum values, high level)

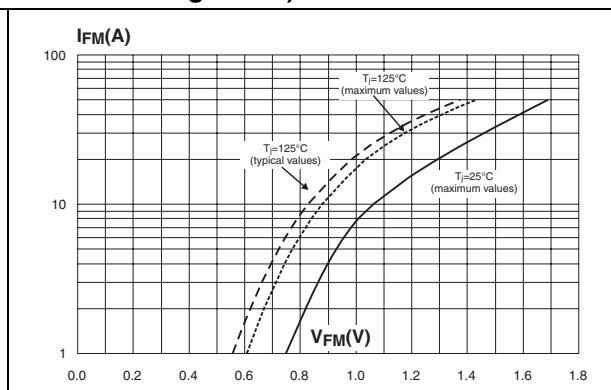

Figure 15. Thermal resistance junction to ambient versus copper surface under each lead - epoxy printed circuit board FR4, copper thickness = 35 μm (SMA)

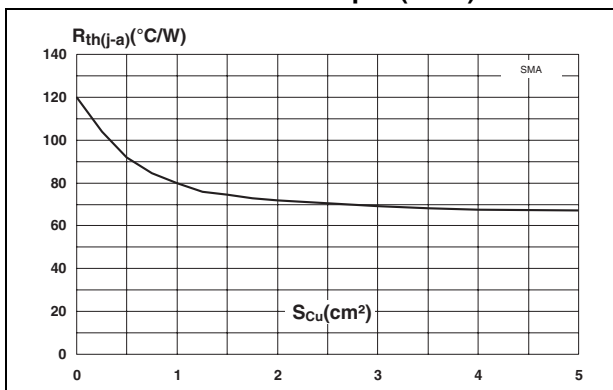

Figure 16. Thermal resistance junction to ambient versus copper surface under each lead - epoxy printed circuit board FR4, copper thickness = 35 μm (SMAflat)

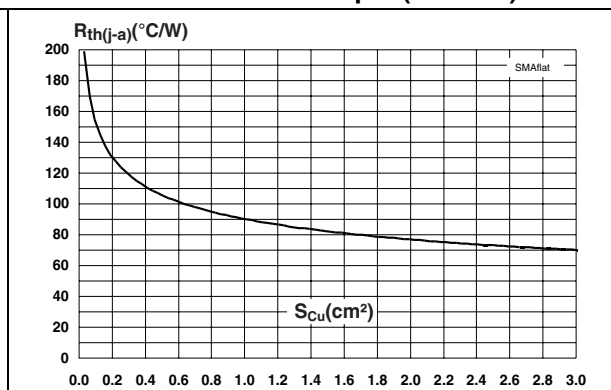
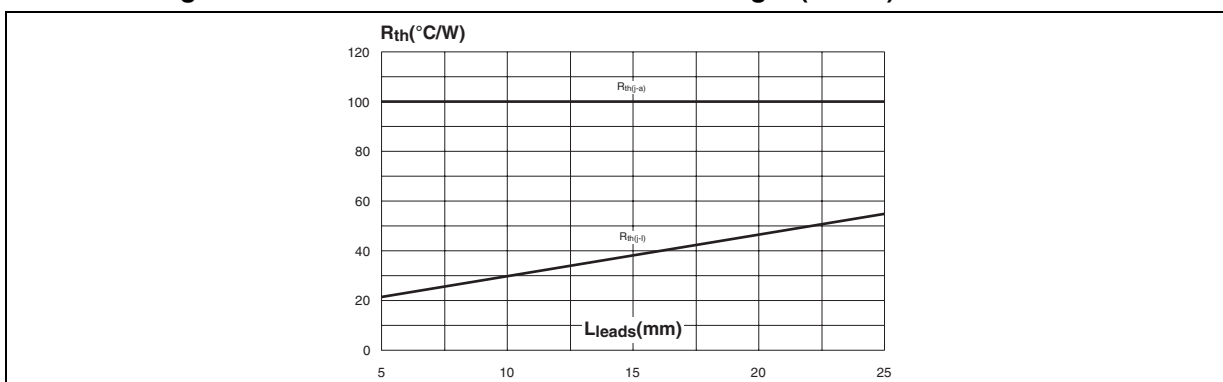

Figure 17. Thermal resistance versus lead length (DO-15)



## 2 Package information

- Epoxy meets UL94, V0.

In order to meet environmental requirements, ST offers these devices in ECOPACK<sup>®</sup> packages. These packages have a lead-free second level interconnect. The category of second level interconnect is marked on the package and on the inner box label, in compliance with JEDEC Standard JESD97. The maximum ratings related to soldering conditions are also marked on the inner box label. ECOPACK is an ST trademark. ECOPACK specifications are available at [www.st.com](http://www.st.com).

**Table 5. SMA package dimensions**

REF.	Dimensions			
	Millimeters		Inches	
	Min.	Max.	Min.	Max.
A1	1.90	2.45	0.075	0.094
A2	0.05	0.20	0.002	0.008
b	1.25	1.65	0.049	0.065
c	0.15	0.40	0.006	0.016
D	2.25	2.90	0.089	0.114
E	4.80	5.35	0.189	0.211
E1	3.95	4.60	0.156	0.181
L	0.75	1.50	0.030	0.059

**Figure 18. SMA footprint dimensions in millimeters (inches)**

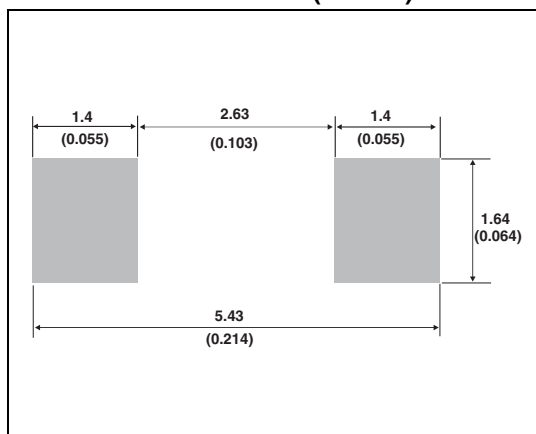

**Figure 19. Marking information**

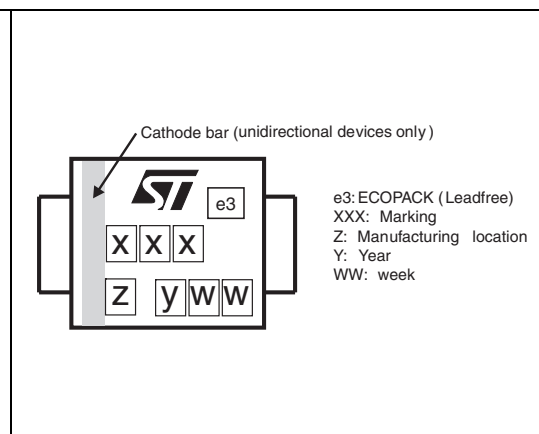

**Table 6. SMAflat dimensions**

Ref.	Dimensions					
	Millimeters			Inches		
	Min.	Typ.	Max.	Min.	Typ.	Max.
A	0.90		1.10	0.035		0.043
b	1.25		1.65	0.049		0.065
c	0.15		0.40	0.006		0.016
D	2.25		2.95	0.088		0.116
E	4.80		5.60	0.189		0.220
E1	3.95		4.60	0.156		0.181
L	0.75		1.50	0.030		0.059
L1		0.50			0.019	
L2		0.50			0.019	

**Figure 20. SMAflat footprint dimensions** **Figure 21. Marking information optimized for SMAflat<sup>(1)</sup>**

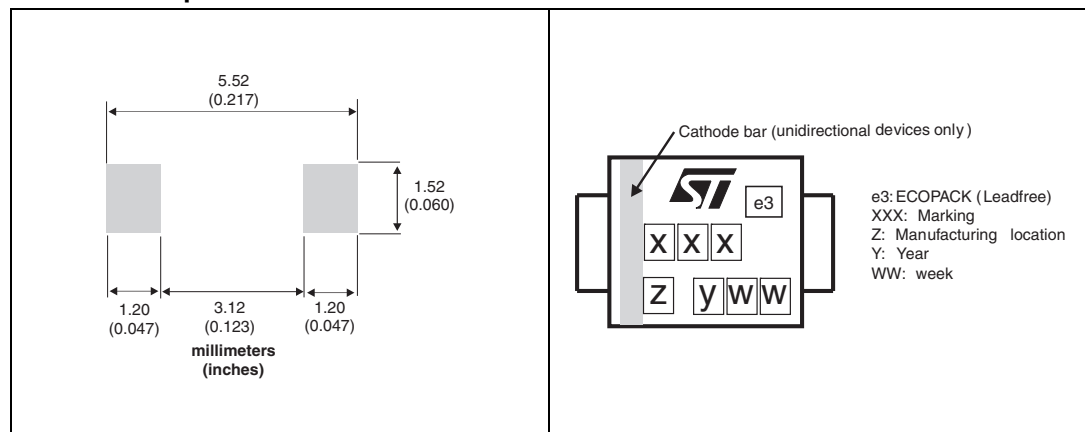

1. SMA footprint may also be used.

**Table 7. DO-15 package dimensions**

REF.	Dimensions			
	Millimeters		Inches	
	Min.	Max.	Min.	Max.
A	6.05	6.75	0.238	0.266
B	2.95	3.53	0.116	0.139
C	26	31	1.024	1.220
D	0.71	0.88	0.028	0.035

### 3 Ordering information

**Table 8. Ordering information**

Order code	Marking	Package	Weight	Base qty	Delivery mode
STPS2150A	2150	SMA	0.068 g	5000	Tape and reel
STPS2150	STPS2150	DO-15	0.4 g	2000	Ammopack
STPS2150RL	STPS2150	DO-15	0.4 g	5000	Tape and reel
STPS2150AF	F2150	SMAflat	0.035 g	1000	Tape and reel

### 4 Revision history

**Table 9. Document revision history**

Date	Revision	Description of changes
Jul-2003	3A	Last update.
Aug-2004	4	SMA package dimensions update. Reference A1 max. changed from 2.70mm (0.106) to 2.03mm (0.080).
31-May-2006	5	Reformatted to current standard. Added ECOPACK statement. Updated SMA footprint in Figure 15. Changed nF to pF in Figure 10.
18-Sep-2008	6	Reformatted to current standard. Added SMAflat package. Removed IF(RMS) from <a href="#">Table 2</a> .



**Please Read Carefully:**

Information in this document is provided solely in connection with ST products. STMicroelectronics NV and its subsidiaries ("ST") reserve the right to make changes, corrections, modifications or improvements, to this document, and the products and services described herein at any time, without notice.

All ST products are sold pursuant to ST's terms and conditions of sale.

Purchasers are solely responsible for the choice, selection and use of the ST products and services described herein, and ST assumes no liability whatsoever relating to the choice, selection or use of the ST products and services described herein.

No license, express or implied, by estoppel or otherwise, to any intellectual property rights is granted under this document. If any part of this document refers to any third party products or services it shall not be deemed a license grant by ST for the use of such third party products or services, or any intellectual property contained therein or considered as a warranty covering the use in any manner whatsoever of such third party products or services or any intellectual property contained therein.

**UNLESS OTHERWISE SET FORTH IN ST'S TERMS AND CONDITIONS OF SALE ST DISCLAIMS ANY EXPRESS OR IMPLIED WARRANTY WITH RESPECT TO THE USE AND/OR SALE OF ST PRODUCTS INCLUDING WITHOUT LIMITATION IMPLIED WARRANTIES OF MERCHANTABILITY, FITNESS FOR A PARTICULAR PURPOSE (AND THEIR EQUIVALENTS UNDER THE LAWS OF ANY JURISDICTION), OR INFRINGEMENT OF ANY PATENT, COPYRIGHT OR OTHER INTELLECTUAL PROPERTY RIGHT.**

**UNLESS EXPRESSLY APPROVED IN WRITING BY AN AUTHORIZED REPRESENTATIVE OF ST, ST PRODUCTS ARE NOT DESIGNED, AUTHORIZED OR WARRANTED FOR USE IN MILITARY, AIR CRAFT, SPACE, LIFE SAVING, OR LIFE SUSTAINING APPLICATIONS, NOR IN PRODUCTS OR SYSTEMS, WHERE FAILURE OR MALFUNCTION MAY RESULT IN PERSONAL INJURY, DEATH, OR SEVERE PROPERTY OR ENVIRONMENTAL DAMAGE.**

Resale of ST products with provisions different from the statements and/or technical features set forth in this document shall immediately void any warranty granted by ST for the ST product or service described herein and shall not create or extend in any manner whatsoever, any liability of ST.

ST and the ST logo are trademarks or registered trademarks of ST in various countries.

Information in this document supersedes and replaces all information previously supplied.

The ST logo is a registered trademark of STMicroelectronics. All other names are the property of their respective owners.

© 2008 STMicroelectronics - All rights reserved

STMicroelectronics group of companies

Australia - Belgium - Brazil - Canada - China - Czech Republic - Finland - France - Germany - Hong Kong - India - Israel - Italy - Japan - Malaysia - Malta - Morocco - Singapore - Spain - Sweden - Switzerland - United Kingdom - United States of America

[www.st.com](http://www.st.com)