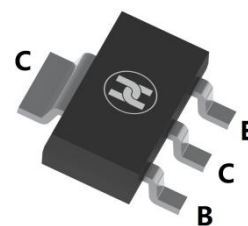
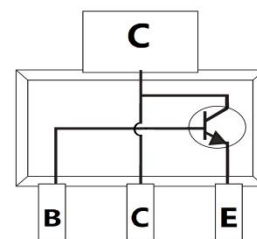

BIPOLAR TRANSISTOR (NPN)
FEATURES

- Complementary to BCP52
- High collector current
- Low collector-emitter saturation voltage
- For AF driver and output stages
- Surface Mount device

SOT-223

MECHANICAL DATA

- Case: SOT-223
- Case Material: Molded Plastic. UL flammability
- Classification Rating: 94V-0
- Weight: 0.04 grams (approximate)
- Marking:BCP55

MAXIMUM RATINGS (T_A = 25°C unless otherwise noted)

Parameter	Symbol	Value	Unit
Collector-Base Voltage	V _{CB0}	60	V
Collector-Emitter Voltage	V _{CEO}	60	V
Emitter-Base Voltage	V _{EBO}	5	V
Collector Current	I _C	1	A
Collector Power Dissipation	P _C	1.5	W
Thermal Resistance From Junction To Ambient	R _{θJA}	83.3	°C/W
Junction Temperature	T _J	150	°C
Storage Temperature	T _{STG}	-55 ~+150	°C

ELECTRICAL CHARACTERISTICS (T_A = 25°C unless otherwise specified)

Parameter	Symbol	Min	Typ	Max	Unit	Conditions
Collector-base breakdown voltage	V _{(BR)CBO}	60			V	I _C =100uA, I _E =0
Collector-emitter breakdown voltage	V _{(BR)CEO}	60			V	I _C =10mA, I _B =0
Emitter-base breakdown voltage	V _{(BR)EBO}	5			V	I _E =10uA, I _C =0
Collector cut-off current	I _{CBO}			0.1	uA	V _{CB} =30V, I _E =0
Emitter cut-off current	I _{EBO}			0.1	uA	V _{EB} =5V, I _C =0
DC current gain	h _{FE}	25				V _{CE} =2V, I _C =5mA
		63		250		V _{CE} =2V, I _C =150mA
		25				V _{CE} =2V, I _C =500mA
Collector-emitter saturation voltage	V _{CE(sat)}			0.5	V	I _C =500mA, I _B =50mA
Base-emitter voltage	V _{BE}			1	V	V _{CE} =2V, I _C =500mA
Transition frequency	f _T	100			MHz	V _{CE} =10V, I _C =50mA, f=100MHz

CLASSIFICATION OF h_{FE}

Rank	BCP55-10	BCP55-16
Range	63-160	100-250
Marking	BCP55-10	BCP55-16

BIPOLAR TRANSISTOR (NPN)

Typical Characteristics

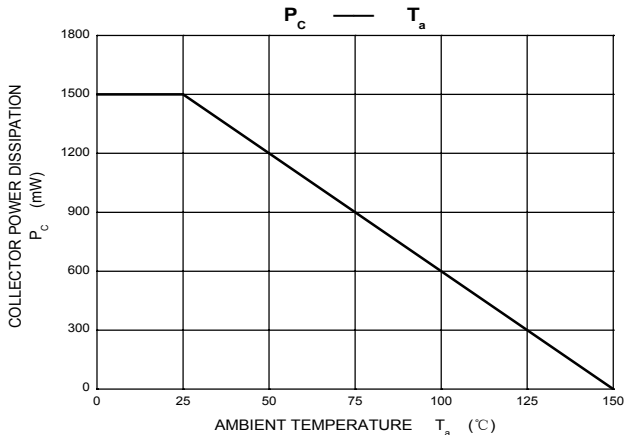
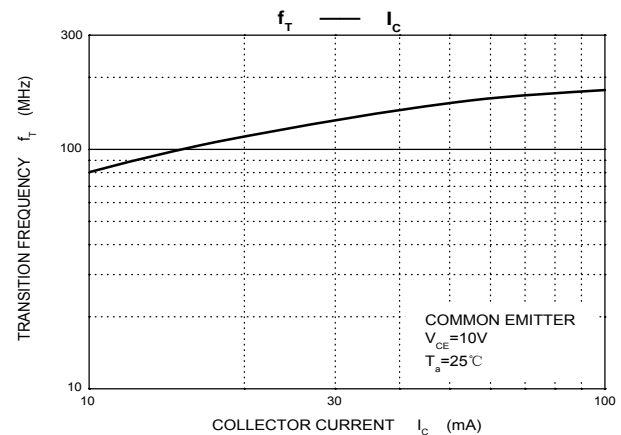
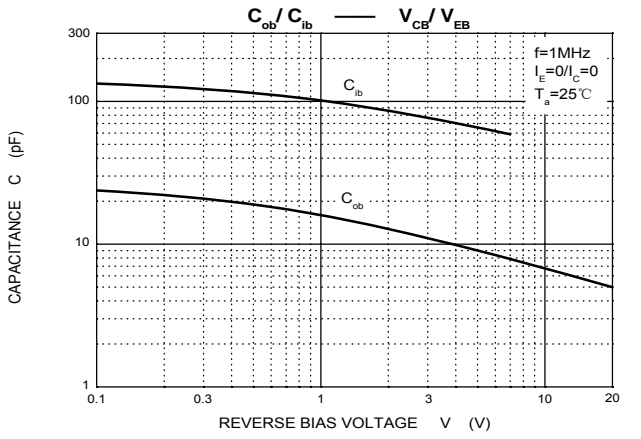
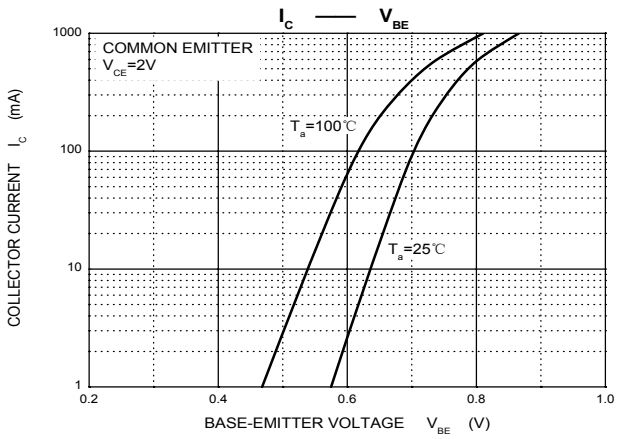
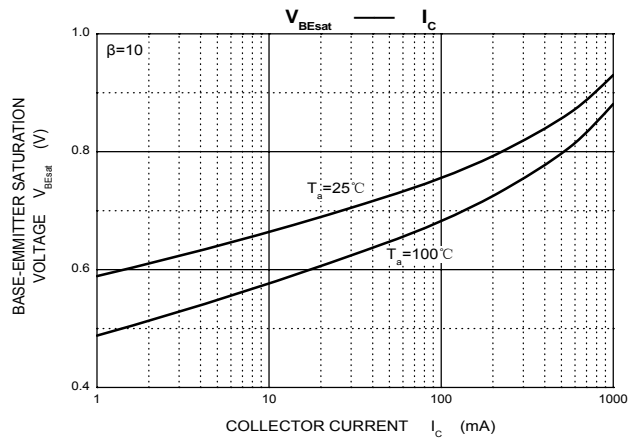
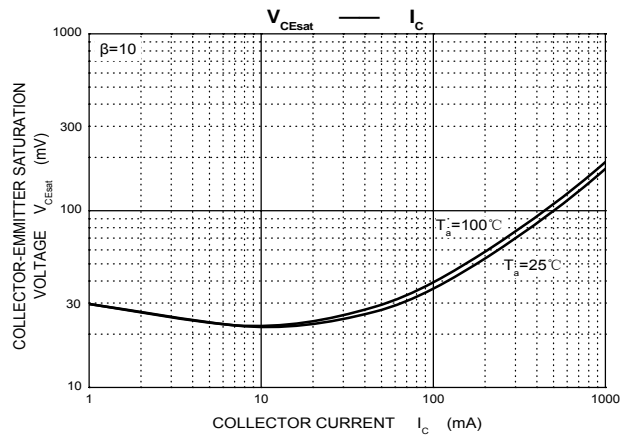
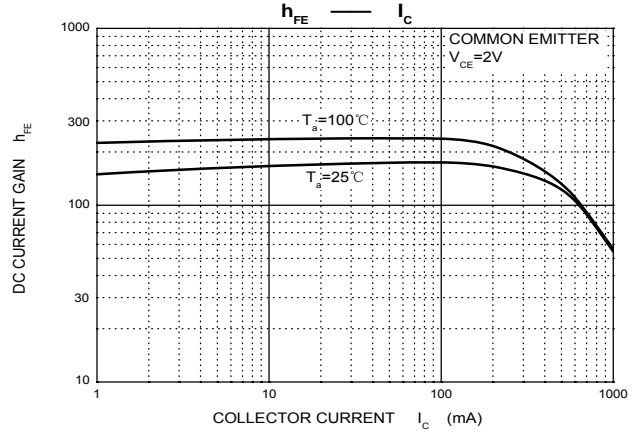
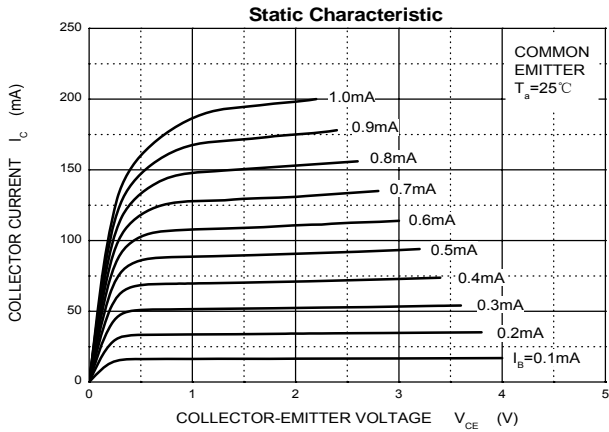

BIPOLAR TRANSISTOR (NPN)

SOT-223 Package Outline Dimensions

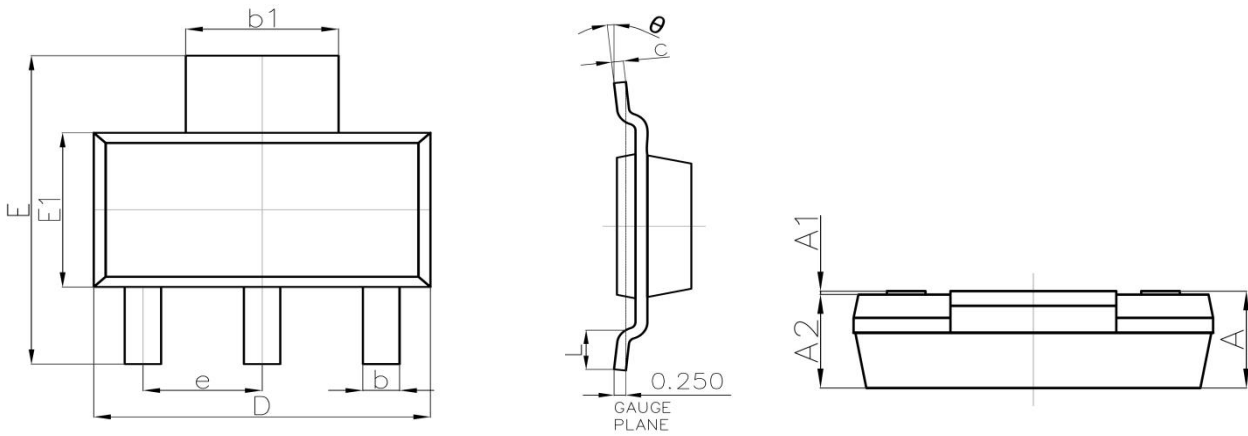

Symbol	Dimensions In Millimeters		Dimensions In Inches	
	Min.	Max.	Min.	Max.
A	—	1.800	-----	0.071
A1	0.020	0.100	0.001	0.004
A2	1.500	1.700	0.059	0.067
b	0.660	0.840	0.026	0.033
b1	2.900	3.100	0.114	0.122
c	0.230	0.350	0.009	0.014
D	6.300	6.700	0.248	0.264
E	6.700	7.300	0.264	0.287
E1	3.300	3.700	0.130	0.146
e	2.300(BSC)		0.091(BSC)	
L	0.750	-----	0.030	-----
θ	0°	10°	0°	10°

SOT-223 Suggested Pad Layout

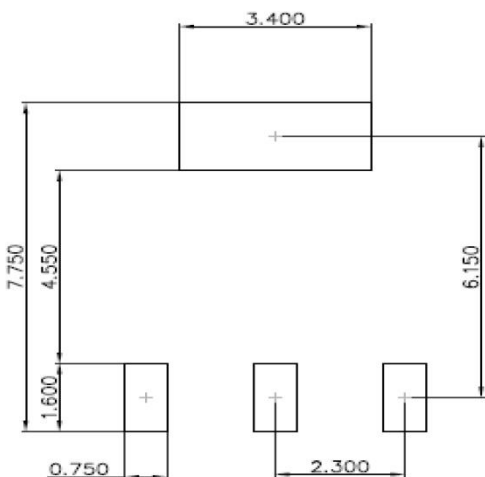

Note:

1. Controlling dimension: in millimeters
2. General tolerance: ±0.05mm
3. The pad layout is for reference purposes only

BIPOLAR TRANSISTOR (NPN)

SOT-223 Tape and Reel

SOT-223 Embossed Carrier Tape

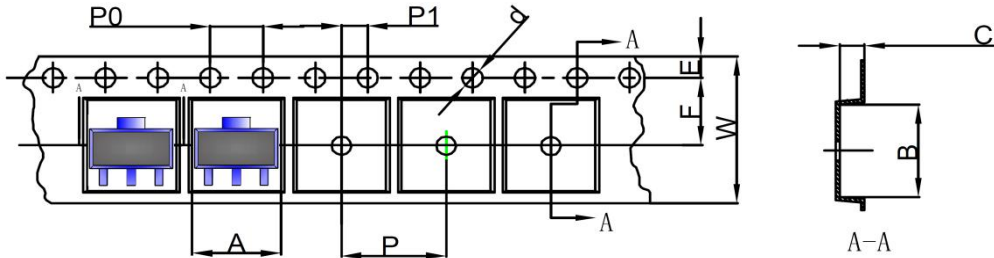

DIMENSIONS ARE IN MILLIMETER										
TYPE	A	B	C	d	E	F	P0	P	P1	W
SOT-223	6.765	7.335	1.88	Ø1.50	1.75	5.50	4.00	4.00	2.00	12.00
TOLERANCE	±0.1	±0.1	±0.1	±0.1	±0.1	±0.1	±0.1	±0.1	±0.1	±0.1

SOT-223 Tape Leader and Trailer

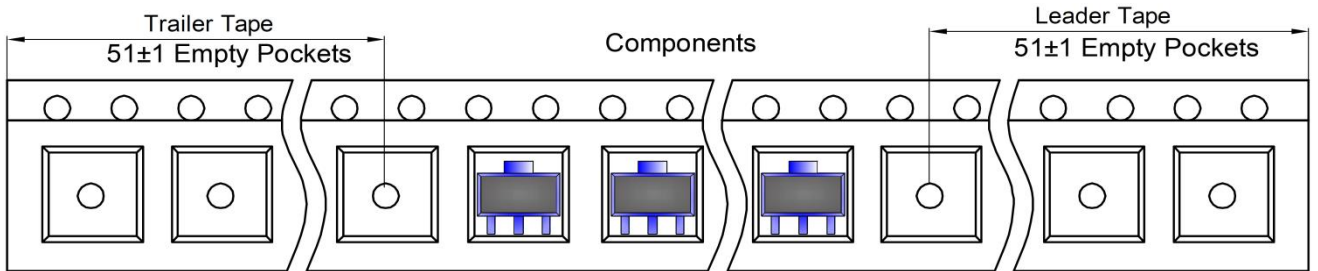

SOT-223 Reel

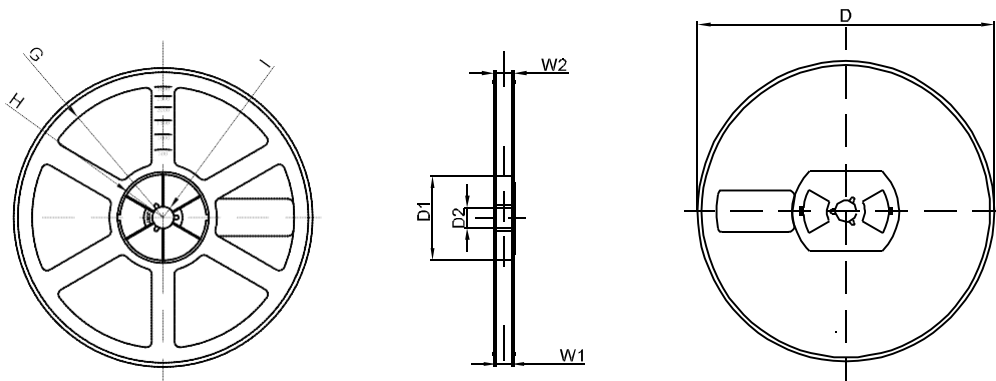

DIMENSIONS ARE IN MILLIMETER								
REEL OPTION	D	D1	D2	G	H	I	W1	W2
13" DIA	Ø330.00	100.00	13.00	R151.00	R56.00	R6.50	12.40	17.60
TOLERANCE	±2	±1	±1	±1	±1	±1	±1	±1