

FEATURES

- * International standard package
- * Planar passivated chips

APPLICATIONS

- * DC motor control
- * Softstart AC motor controller
- * Light, heat and temperature control

ADVANTAGES

- * Space and weight savings
- * Simple mounting with two screws
- * Improved temperature and power cycling

Symbol	Test Conditions	Maximum Ratings	Unit
I_{TRMS} , I_{FRMS} I_{TAVM} , I_{FAVM}	$T_{VJ}=T_{VJM}$ $T_C=85^{\circ}C$; 180° sine	256 162	A
I_{TSM} , I_{FSM}	$T_{VJ}=45^{\circ}C$ t=10ms (50Hz), sine $V_R=0$ t=8.3ms (60Hz), sine	5500 5850	A
	$T_{VJ}=T_{VJM}$ t=10ms(50Hz), sine $V_R=0$ t=8.3ms(60Hz), sine	4800 5100	
i_{zdt}	$T_{VJ}=45^{\circ}C$ t=10ms (50Hz), sine $V_R=0$ t=8.3ms (60Hz), sine	151000 142000	A2s
	$T_{VJ}=T_{VJM}$ t=10ms(50Hz), sine $V_R=0$ t=8.3ms(60Hz), sine	115000 108000	
$(di/dt)_{cr}$	$T_{VJ}=T_{VJM}$ repetitive, $I_T=45A$ f=50Hz, $t_p=200\mu s$ $V_D=2/3V_{DRM}$	150	A/us
	$I_G=0.45A$ non repetitive, $I_T=I_{TAVM}$ $di_G/dt=0.45A/\mu s$	500	
$(dv/dt)_{cr}$	$T_{VJ}=T_{VJM}$; $V_{DR}=2/3V_{DRM}$ $R_{GK}=\ ;$ method 1 (linear voltage rise)	1000	V/us
P_{GM}	$T_{VJ}=T_{VJM}$ $t_p=30\mu s$	120	W
	$I_T=I_{TAVM}$ $t_p=300\mu s$	60	
P_{GAV}		8	W
V_{RGM}		10	V
T_{VJ} T_{VJM} T_{stg}		-40...+125 125 -40...+125	$^{\circ}C$
V_{ISOL}	50/60Hz, RMS t=1min	3000	V~
	$I_{ISOL}<1mA$ t=1s	3600	
M_d	Mounting torque (M5)	2.5-4.0/22-35	Nm/lb.in.
	Terminal connection torque (M5)	2.5-4.0/22-35	
Weight	Typical including screws	280	g

Symbol	Test Conditions	Maximum Ratings	Unit
IRRM, IDRM	TVJ=TVJM; VR=VRRM; VD=VDRM	10	mA
VT, VF	IT, IF=160A; TVJ=25oC	1.35	V
VTO	For power-loss calculations only (TVJ=125oC)	0.8	V
rT		1.5	mΩ
VGT	VD=6V; TVJ=25oC	2.5	V
	TVJ=-40oC	2.6	
IGT	VD=6V; TVJ=25oC	150	mA
	TVJ=-40oC	200	
VGD	TVJ=TVJM; VD=2/3VDRM	0.2	V
IGD		10	mA
IL	TVJ=25oC; tp=10us; VD=6V	300	mA
	IL IG=0.45A; diG/dt=0.45A/us		
IH	TVJ=25oC; VD=6V; RGK=	200	mA
tgD	TVJ=25oC; VD=1/2VDRM IG=0.45A; diG/dt=0.45A/us	2	us
tq	TVJ=TVJM; IT=20A; tp=200us; -di/dt=10A/us typ. VR=100V; dv/dt=20V/us; VD=2/3VDRM	150	us
QS	TVJ=TVJM; IT, IF=25A; -di/dt=0.64A/us	550	uC
IRM		235	A
RthJC	per thyristor/diode; DC current	0.23	K/W
	per module	0.115	
RthJK	per thyristor/diode; DC current	0.33	K/W
	per module	0.165	
dS	Creeping distance on surface	12.7	mm
dA	Strike distance through air	9.6	mm
a	Maximum allowable acceleration	50	m/s ²

Outline Table

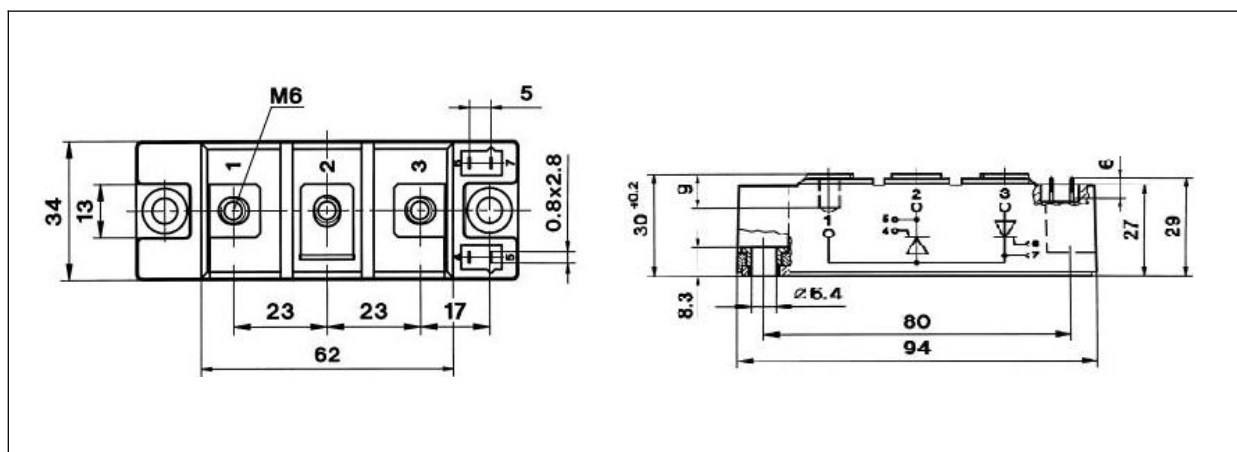

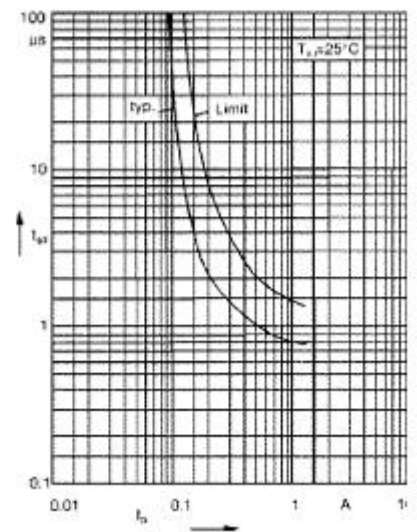
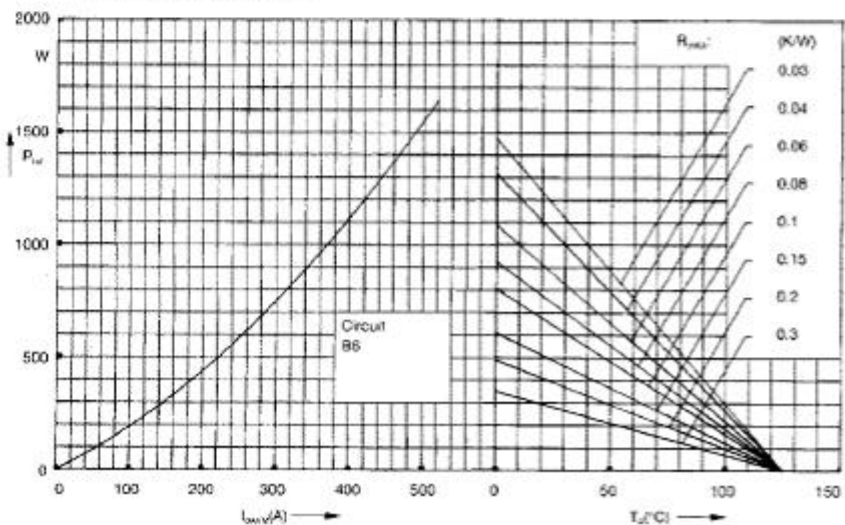
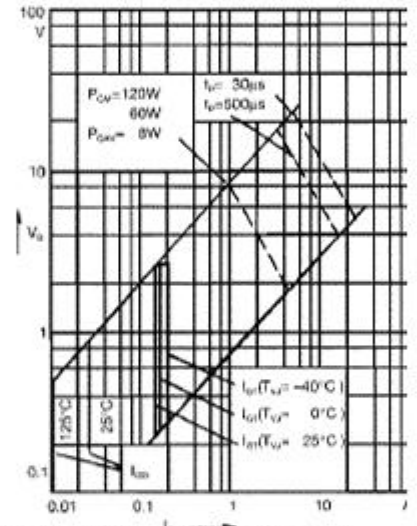
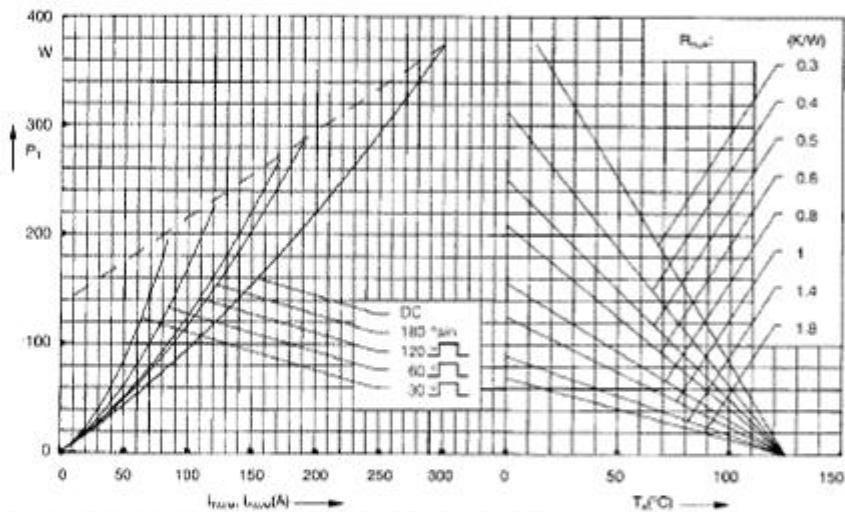
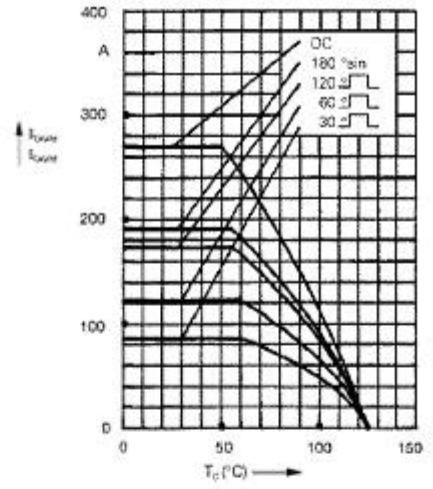
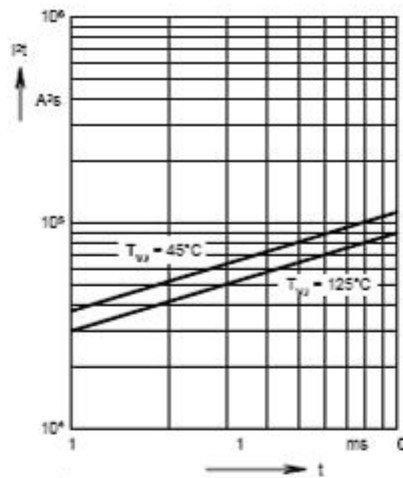
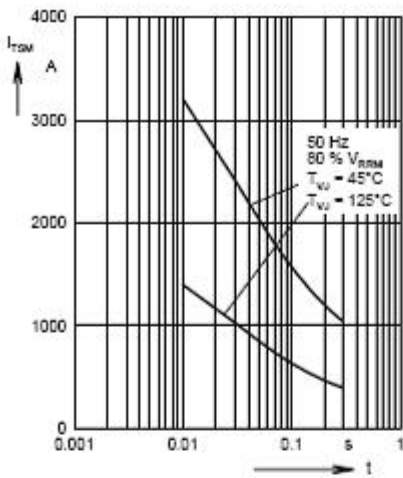

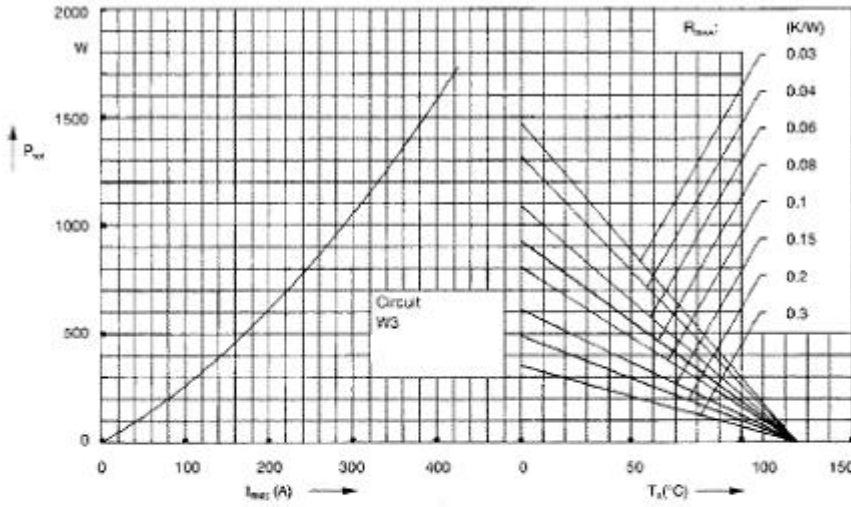

Fig. 7 Three phase AC-controller: Power dissipation versus RMS output current and ambient temperature

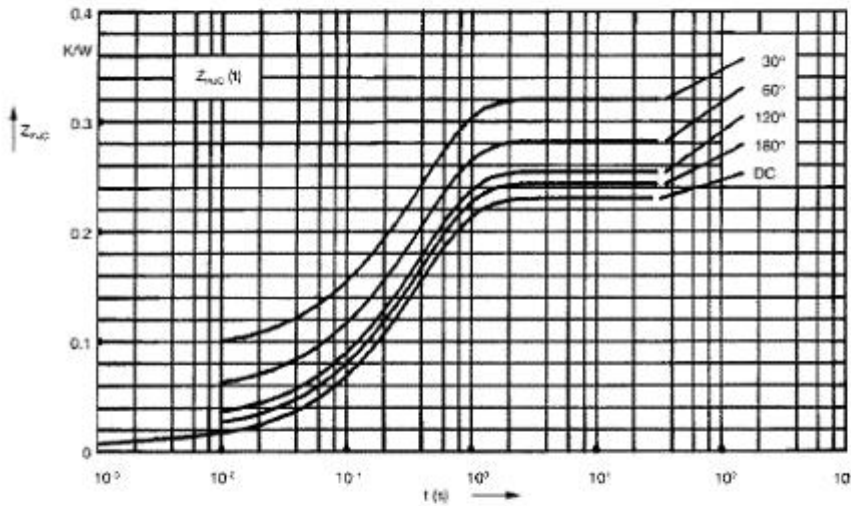

Fig. 8 Transient thermal impedance junction to case (per thyristor or diode)

$R_{\theta(jc)}$ for various conduction angles d:

d	$R_{\theta(jc)}$ (K/W)
DC	0.230
180°	0.244
120°	0.255
60°	0.283
30°	0.321

Constants for $Z_{\theta(jc)}$ calculation:

i	$R_{\theta i}$ (K/W)	t_i (s)
1	0.0095	0.001
2	0.0175	0.065
3	0.203	0.4

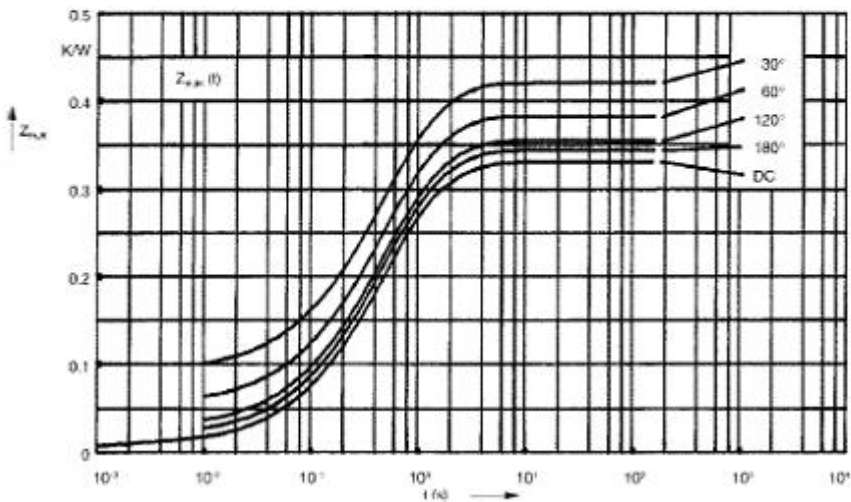

Fig. 9 Transient thermal impedance junction to heatsink (per thyristor or diode)

$R_{\theta(jh)}$ for various conduction angles d:

d	$R_{\theta(jh)}$ (K/W)
DC	0.330
180°	0.344
120°	0.355
60°	0.383
30°	0.421

Constants for $Z_{\theta(jh)}$ calculation:

i	$R_{\theta i}$ (K/W)	t_i (s)
1	0.0095	0.001
2	0.0175	0.065
3	0.203	0.4
4	0.1	1.29