



# 产 品 承 认 书

Product Specification For Approval

CUSTOMER: \_\_\_\_\_

Description: Aluminium Electrolytic Capacitors

SERIES: CD11RE

ITEM: 25V330 /25V470/35V1000

50V220/50V330/50V470/50V1000

| PREPARED BY                                                                              | CHECKED BY            | APPROVED BY        |
|------------------------------------------------------------------------------------------|-----------------------|--------------------|
| 徐 亚 平<br>XU YA PING                                                                      | 朱 宗 美<br>ZHUZHONG MEI | 葛 玉 霞<br>GE YU XIA |
| 发行日期: 2022 年 9 月 12 日<br>Release date: September 12, 2022<br>工程部的 Engineering Department |                       |                    |



| APPROVED BY |
|-------------|
|             |

南通星晨电子有限公司  
Nantong Xingchen Electron Co., Ltd

| <b>Nantong Xingchen Electron Co. Ltd.<br/>Products Acknowledgement</b> | <b>Series: CD11RE</b>   |
|------------------------------------------------------------------------|-------------------------|
| <b>目 录 Catalog</b>                                                     | <b>Part C/ Aug,2017</b> |
| 1. 目录 Catalog .....                                                    | 2                       |
| 2. 产品执行规范 Product Execution Specification .....                        | 3                       |
| 3. 产品工艺流程图 Product Flow Chart .....                                    | 4-5                     |
| 4. 产品概述 Product Overview .....                                         | 6-7                     |
| 5. 产品电性能 Electrical Performance .....                                  | 8-9                     |
| 6. 产品耐久性及机械特性 Durability And Mechanical Properties.....                | 10-11                   |
| 8. 外形尺寸 Outline Dimension .....                                        | 12                      |
| 9. 技术参数 Technical Parameter .....                                      | 13                      |
| 9. 主要材料清单 List Of Main Materials .....                                 | 14                      |
| 10. 包装 Pack .....                                                      | 15-16                   |
| 11. 标识 Characteristic .....                                            | 17                      |
| 12. 使用注意事项 Notice Of Use .....                                         | 18-19                   |

|                                                                                                                                                                                                                                                                                                                                                                                                                                                                                                                                                               |                         |
|---------------------------------------------------------------------------------------------------------------------------------------------------------------------------------------------------------------------------------------------------------------------------------------------------------------------------------------------------------------------------------------------------------------------------------------------------------------------------------------------------------------------------------------------------------------|-------------------------|
| <b>Nantong Xingchen Electron Co. Ltd.<br/>Products Acknowledgement</b>                                                                                                                                                                                                                                                                                                                                                                                                                                                                                        | <b>Series: CD11RE</b>   |
| <b>产品执行规范 Product Execution Specification</b>                                                                                                                                                                                                                                                                                                                                                                                                                                                                                                                 | <b>Part C/ Aug,2017</b> |
| <b>产品执行规范 Product Execution Specification</b>                                                                                                                                                                                                                                                                                                                                                                                                                                                                                                                 |                         |
| <p>1、GB/T2693-2001 IEC60384-1 《电子设备用固定电容器第一部分：总规范》。Fixed capacitors for use in electronic equipment part 1:general specification.</p> <p>2、GB/T5993-2003 IEC60384-4 《电子设备用固定电容器 第四部分：分规范固体和非固体电解质电容器》。Fixed capacitors for use in electronic equipment part 4:sectional specification for solid and non solid electrolyte capacitors.</p> <p>3、GB/T5994-2003 IEC60384-4-1 《电子设备用固定电容器 第四部分：空白详细规范、非固体电解质铝电解电容器》。Fixed capacitors for use in electronic equipment part 4:blank detail specification、non solid electrolyte aluminum electrolytic capacitor.</p> |                         |

|                                                                              |                         |
|------------------------------------------------------------------------------|-------------------------|
| <b>Nantong Xingchen Electron Co. Ltd.</b><br><b>Products Acknowledgement</b> | <b>Series: CD11RE</b>   |
| <b>产品工艺流程图 Product Flow Chart</b>                                            | <b>Part C/ Aug.2017</b> |

### 产 品 工 艺 流 程 图

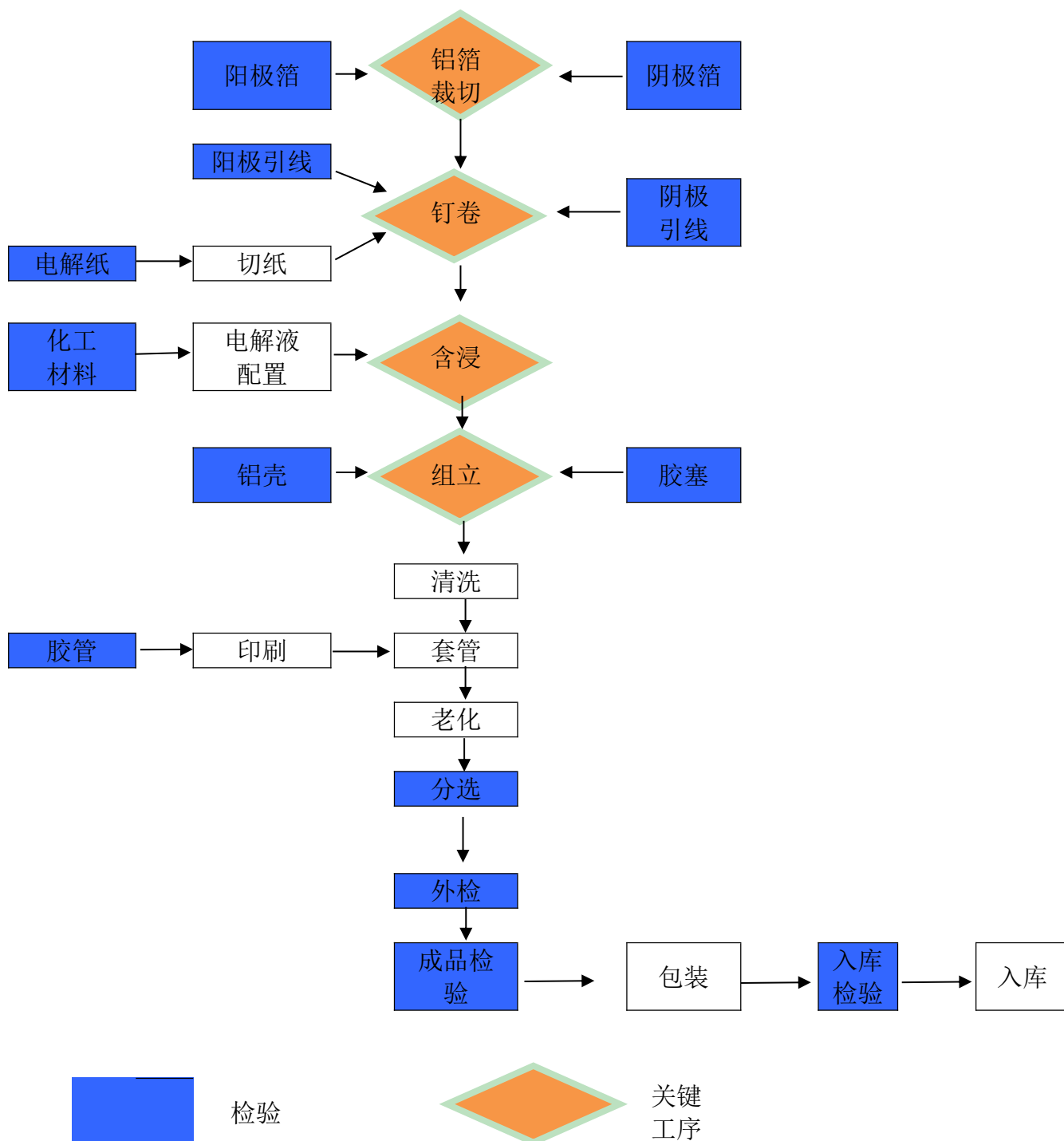

|                                                                |                   |
|----------------------------------------------------------------|-------------------|
| Nantong Xingchen Electron Co. Ltd.<br>Products Acknowledgement | Series: CD11RE    |
| 产品工艺流程图 Product Flow Chart                                     | Part C/ Aug, 2017 |

产 品 工 艺 流 程 图 Product Flow Chart

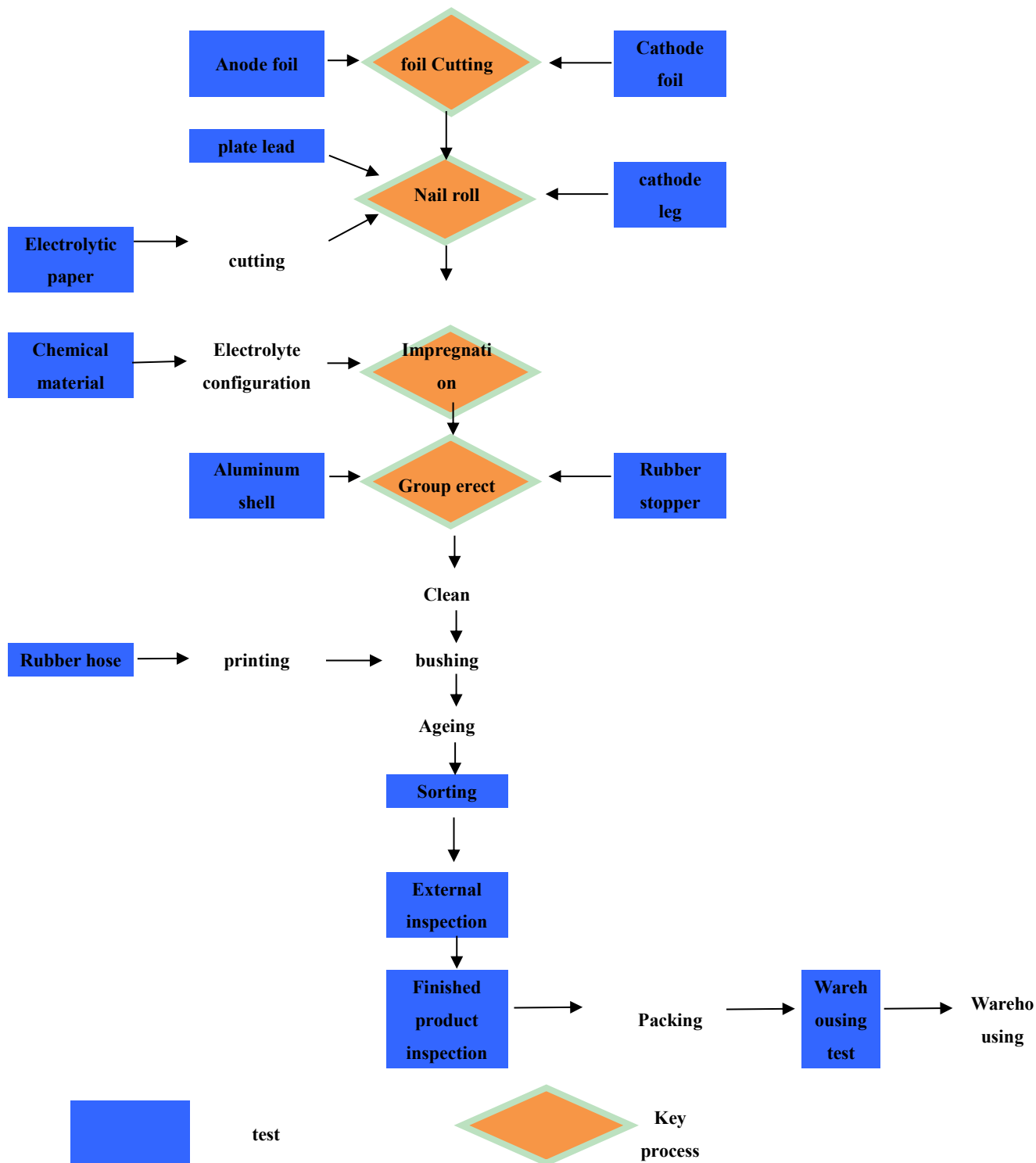

|                                                                                                                                                                                                                                                                                                                                                                                                                                                                                                                                                                                                                                                                                                                                                                                                                                                                                                                                                                                                                                                                                                                                                                                                                                                                                                                                                                                                         |                                               |
|---------------------------------------------------------------------------------------------------------------------------------------------------------------------------------------------------------------------------------------------------------------------------------------------------------------------------------------------------------------------------------------------------------------------------------------------------------------------------------------------------------------------------------------------------------------------------------------------------------------------------------------------------------------------------------------------------------------------------------------------------------------------------------------------------------------------------------------------------------------------------------------------------------------------------------------------------------------------------------------------------------------------------------------------------------------------------------------------------------------------------------------------------------------------------------------------------------------------------------------------------------------------------------------------------------------------------------------------------------------------------------------------------------|-----------------------------------------------|
| <p align="center"><b>Nantong Xingchen Electron Co. Ltd.</b><br/><b>Products Acknowledgement</b></p>                                                                                                                                                                                                                                                                                                                                                                                                                                                                                                                                                                                                                                                                                                                                                                                                                                                                                                                                                                                                                                                                                                                                                                                                                                                                                                     | <p align="center"><b>Series: CD11RE</b></p>   |
| <p align="center">产品概述 <b>Product Overview</b></p>                                                                                                                                                                                                                                                                                                                                                                                                                                                                                                                                                                                                                                                                                                                                                                                                                                                                                                                                                                                                                                                                                                                                                                                                                                                                                                                                                      | <p align="center"><b>Part C/ Aug,2017</b></p> |
| <p align="center"><b>铝电解电容器电性能测试规范</b></p> <p align="center"><b>Standard for testing electrical properties of aluminum electrolytic capacitors</b></p> <p>一、测试环境要求：<br/>如果没有其他规定，标准的测试、检验环境条件如下所示：<br/>1、 温度：15~35℃（产品处于此环境中 10 小时以上）<br/>2、 相对湿度：40~75%RH<br/>3、 大气压力：86~106kpa<br/>如果对测试结果有异议，可以在以下条件测试<br/>1、 温度：20℃（产品处于此环境中 10 小时以上）<br/>2、 相对湿度：60~70%RH<br/>3、 大气压力：86~106kpa</p> <p>Condition of tese:<br/>Unless otherwise specified,the standard range of atmospheric condition for making measurements and tests are as follows<br/>1、 Temperature: 15~35℃ (The product is in this environment for more than 10 hours)<br/>2、 Relative humidity: 40~75%RH<br/>3、 Atmospheric pressure: 86~106kpa<br/>If there may be doubt on the results, measurements shall be made within the following limits:<br/>1、 Temperature: 20℃ (The product is in this environment for more than 10 hours)<br/>2、 Relative humidity: 60~70%RH<br/>3、 Air pressure: 86~106kpa</p> <p>二、电容量的测量：<br/>1、 测试频率：100Hz or 120Hz<br/>2、 测试电压：1Vrms 以下<br/>3、 测试电路：串联等效<br/>4、 测量精度：应小于电容器允许偏差的 10%或电容量绝对的 2%，取较小者。</p> <p>Measurement of capacitance:<br/>1、 Measuring frequency: 100Hz or 120Hz<br/>2、 Measuring voltage: Below 1Vrms<br/>3、 Measuring circuit:Series equivalent circuit<br/>4、 Measurement accuracy: should be less than 10% of the allowable deviation of the capacitor or 2% of the capacitance。</p> |                                               |

三、损耗角正切：

- 1、测试频率：100Hz or 120Hz
- 2、测试夹具接触良好，测量连接线尽量短。

Dissipation factor:

- 1、Measuring frequency: 100Hz or 120Hz
- 2、The test fixture is in good contact and the measuring connection is as short as possible.

四、漏电流

- 1、测试前，电容器要充分放电，按“+”、“-”极性正确连线。
- 2、在电容器两端施加额定工作电压，并串联  $1000\pm 100\Omega$ 电阻，在施加电压两分钟后，测量漏电流。
- 3、测试电压为标称电压，测试时间为 1~5 分钟，读数为 1~5 分钟的读数。

Leakage current:

- 1、before testing, capacitors should be fully discharged, and connect correctly according to the polarity of "+" and "-".
- 2、The rated voltage shall be applied across the capacitor and its protective resistor shall be  $1000\pm 100\Omega$ . The leakage current shall then be measured after an electrification period of 2 min.
- 3、The test voltage is nominal voltage, the test time is 1~5 minutes, and the reading is 1~5 minutes.

五、抽样方案按 GB2828-87 记数抽样程序

- 1、电性能：一般检查水平 II AQL=0.065
- 2、外观：检查水平 S-4 AQL=0.1

Sampling program according to GB2828-87 number sampling procedure:

- 1、Electrical properties: General check level II AQL=0.065
- 2、Appearance: Check level S-4 AQL=0.1

| Nantong Xingchen Electron Co. Ltd.<br>Products Acknowledgement |                                                                                                                                                                                      | Series: CD11RE                                                      |                              |      |
|----------------------------------------------------------------|--------------------------------------------------------------------------------------------------------------------------------------------------------------------------------------|---------------------------------------------------------------------|------------------------------|------|
| 产品电性能 Electrical Performance                                   |                                                                                                                                                                                      | Part C/ Aug,2017                                                    |                              |      |
| 一、适用范围：<br>本规格书适用于南通星晨电子有限公司 CD11RE 型系列铝电解电容产品的规定。             |                                                                                                                                                                                      |                                                                     |                              |      |
| 二、性能指标                                                         |                                                                                                                                                                                      |                                                                     |                              |      |
| 温度范围<br>Temperature range                                      | -40℃~+105℃                                                                                                                                                                           |                                                                     |                              |      |
| 电压范围 Rated<br>voltage range                                    | 25V                                                                                                                                                                                  | 35V                                                                 | 50V                          |      |
| 标称容量 Nominal<br>capacitance (μF)                               | 330uF/470uF                                                                                                                                                                          | 1000uF                                                              | 220uF/330uF/470uF/<br>1000uF |      |
| 容量范围<br>Capacitance<br>tolerance                               | -20%~+20%                                                                                                                                                                            |                                                                     |                              |      |
| 漏电流 (μA) Leakage<br>current                                    | 工作电压 (V)<br>Rated voltage                                                                                                                                                            | 25V                                                                 | 35V                          | 50V  |
|                                                                | 漏电流(2min)<br>Leakage current                                                                                                                                                         | I≤0.01CVμA                                                          |                              |      |
| 工作电压 (V)<br>Rated voltage                                      | 工作电压 (V)<br>Rated voltage                                                                                                                                                            | 25V                                                                 | 35V                          | 50V  |
|                                                                | Tanδ                                                                                                                                                                                 | 0.14                                                                | 0.12                         | 0.10 |
| 负荷寿命 Load life<br>(+105℃)                                      | 时 间 Life time                                                                                                                                                                        | 105±2℃ 5000 Hours                                                   |                              |      |
|                                                                | 漏电流 Leakage current                                                                                                                                                                  | 不大于初始规定值<br>Not more than the specified value                       |                              |      |
|                                                                | 容量变化率 Capacitance change                                                                                                                                                             | 在初始值的±20%以内<br>Within±20% of the initial value                      |                              |      |
|                                                                | 损耗角正切值 Dissipation factor                                                                                                                                                            | 不大于初始规定值的 200% Not more<br>than 200% of specified value             |                              |      |
|                                                                | 在 105℃ 环境中, 连续加载直流电压与额定纹波电流, (所加电压峰值不超过额定电压)规定时间后, 恢复至少 16 小时, 应满足上表要求。<br>After application of the rated voltage at 105℃ 5000hours ,the capacitor shall meet the above requirement. |                                                                     |                              |      |
| 贮存寿命 Shelf life<br>(+105℃)                                     | 电容器在无负荷, 105℃ 贮存 1000 小时, 恢复至少 16 小时后施加额定电压 30 分钟测试, 测试其性能应满足:<br>The capacitors are stored without voltage load at 105±2℃ for 1000 hours and then resumed 16 hours.                 |                                                                     |                              |      |
|                                                                | 漏电流 Leakage current                                                                                                                                                                  | 不大于初始规定值的 200%<br>Not greater than 200% of the initial set<br>value |                              |      |
|                                                                | 容量变化率 Capacitance change                                                                                                                                                             | 在初始值的±20%以内<br>Within ±20% of the value before test.                |                              |      |
|                                                                | 损耗角正切值 Dissipation factor                                                                                                                                                            | 不大于初始规定值的 200%                                                      |                              |      |



|                                       |                                                                                                                                                                                                                                                                                                                                                                                                                                                                                                                                                                                                                                                                                                                                                                                                            |                                 |      | Not more than 200% of the specified value                                                                                                                                                                                                                                                                                                                                                                                                                                                                                                                                                                                                                                                                                                                                                                                                  |
|---------------------------------------|------------------------------------------------------------------------------------------------------------------------------------------------------------------------------------------------------------------------------------------------------------------------------------------------------------------------------------------------------------------------------------------------------------------------------------------------------------------------------------------------------------------------------------------------------------------------------------------------------------------------------------------------------------------------------------------------------------------------------------------------------------------------------------------------------------|---------------------------------|------|--------------------------------------------------------------------------------------------------------------------------------------------------------------------------------------------------------------------------------------------------------------------------------------------------------------------------------------------------------------------------------------------------------------------------------------------------------------------------------------------------------------------------------------------------------------------------------------------------------------------------------------------------------------------------------------------------------------------------------------------------------------------------------------------------------------------------------------------|
| 温度特性<br>temperature<br>characteristic | 阶段                                                                                                                                                                                                                                                                                                                                                                                                                                                                                                                                                                                                                                                                                                                                                                                                         | 温度                              | 时间   | 阶段 1: 测量容量和阻抗 ( $ z  20^{\circ}\text{C} 120\text{Hz}\pm 20\%$ )<br>阶段 2: 电容器恒温贮存 2 小时, 在热平衡状态下测阻抗 ( $ z  -25^{\circ}\text{C} 120\text{Hz}\pm 20\%$ )<br>阶段 3: 电容器恒温贮存 2 小时后, 在热平衡状态测电容量<br>阶段 2 阻抗值与阶段 1 阻抗值相比, 不大于 3; 阶段 3 容量变化应在初始值的 $\pm 20\%$ 范围内<br>Step1: Capacitance and impedance shall be measured. ( $ z  20^{\circ}\text{C} 120\text{Hz}\pm 20\%$ )<br>Step2: After the capacitor being stored for 2 hours, impedance shall be measured at thermal stability ( $ z  -25^{\circ}\text{C} 120\text{Hz}\pm 20\%$ )<br>Step3: After the capacitor being stored for 2 hours, capacitance shall be measured. The measurement shall be made at thermal stability<br>Phase 2 impedance value is not greater than 3 compared with stage 1 impedance value; stage 3 capacity change should be within the range of + 20% of initial value. |
|                                       | 1                                                                                                                                                                                                                                                                                                                                                                                                                                                                                                                                                                                                                                                                                                                                                                                                          | $20\pm 2^{\circ}\text{C}$       | ---- |                                                                                                                                                                                                                                                                                                                                                                                                                                                                                                                                                                                                                                                                                                                                                                                                                                            |
|                                       | 2                                                                                                                                                                                                                                                                                                                                                                                                                                                                                                                                                                                                                                                                                                                                                                                                          | $+0$<br>$-25-3^{\circ}\text{C}$ | 2h   |                                                                                                                                                                                                                                                                                                                                                                                                                                                                                                                                                                                                                                                                                                                                                                                                                                            |
|                                       | 3                                                                                                                                                                                                                                                                                                                                                                                                                                                                                                                                                                                                                                                                                                                                                                                                          | $+3$<br>$105-0^{\circ}\text{C}$ | 2h   |                                                                                                                                                                                                                                                                                                                                                                                                                                                                                                                                                                                                                                                                                                                                                                                                                                            |
| 耐浪涌电压<br>Surge voltage                | <p>施加表 1 所示浪涌电压, 充电 <math>30\pm 5</math> 秒, 放电 <math>5.5\pm 0.5</math> 分钟作为一个周期, 共进行 1000 次。</p> <p>Application of DC surge Voltage stated at table-1, 1000 times of charging for <math>30 \pm 5</math> sec., discharging with a period of <math>5.5\pm 0.5</math> min.</p> <p>测试温度 Test temperature: <math>15-35^{\circ}\text{C}</math></p> <p>然后在标准大气压条件下放置到达热稳定, 测试各参数</p> <p>And the capacitor shall be stored under standard atmospheric conditions to obtain thermal stability, after which measurements shall be made.</p> <p>容量: 不低于试验前的 80%; 损耗角正切值不大于 200% 的初始规定值; 漏电流: 达到上表要求</p> <p>Capacitance change: Within <math>\pm 20\%</math> of the initial value Dissipation factor: Not more than 200% of the specified value.</p> <p>leakage current: meet the requirements of the above table.</p> |                                 |      |                                                                                                                                                                                                                                                                                                                                                                                                                                                                                                                                                                                                                                                                                                                                                                                                                                            |

|                                                                              |                         |
|------------------------------------------------------------------------------|-------------------------|
| <b>Nantong Xingchen Electron Co. Ltd.</b><br><b>Products Acknowledgement</b> | <b>Series: CD11RE</b>   |
| <b>产品耐久性及其机械特性 Product Durability And Mechanical Properties</b>              | <b>Part C/ Aug,2017</b> |

## 一、耐久性能 Durability

|                                 |                                                                                                                                                                                                                                                                                                                                                                          |                                                                                                                                                                                                                                                                                              |
|---------------------------------|--------------------------------------------------------------------------------------------------------------------------------------------------------------------------------------------------------------------------------------------------------------------------------------------------------------------------------------------------------------------------|----------------------------------------------------------------------------------------------------------------------------------------------------------------------------------------------------------------------------------------------------------------------------------------------|
| 稳态湿热<br>Resistance to damp heat | <p>依据 IEC60068-2-6 试验<br/>According to the IEC60068-2-6 test<br/>试验温度 Test temperature: <math>40\pm 2^{\circ}\text{C}</math><br/>试验时间 Test time: <math>240\pm 8\text{h}</math><br/>相对湿度 relative humidity: 90~95%<br/>试验后, 电容器在标准大气条件下 1~2 小时, 然后测试参数<br/>After testing, the capacitor is 1~2 hours under standard atmospheric conditions, and then test parameters.</p> | <p>容量变化: 在初始值<math>\pm 10\%</math>范围内<br/>Within <math>\pm 10\%</math> of the initial value.<br/>损耗角正切: 不大于规定值<br/>Dissipation factor:: not more than the specified value<br/>漏电流 Leakage current:<br/><math>I \leq 0.01CV\mu\text{A}</math><br/>要求 外观: 无异常<br/>Appearance: no exception</p> |
| 耐焊接热<br>Welding heat resistance | <p>焊槽法: 焊锡温度: <math>260\pm 5^{\circ}\text{C}</math>; 浸入时间: <math>10\pm 1</math> 秒; 电路板: 1.6 mm<br/>Solder bath method: solder temperature: <math>260 + 5\text{ C}</math>; immersion time: <math>10 + 1\text{ sec}</math>; Printed wiring board: 1.6mm</p>                                                                                                                |                                                                                                                                                                                                                                                                                              |
|                                 |                                                                                                                                                                                                                                                                                                                                                                          |                                                                                                                                                                                                                                                                                              |

## 二、机械特性 Mechanical properties

|                                         |                                                                                                                                                                                                                                                                                                                                                                                                                                                                                                                                                                                                                                                                                                                                                                                                                                                                                                                                                                                                                                                                                                                                                                                                                                       |                   |     |     |     |      |   |    |    |                   |     |     |     |      |     |   |   |
|-----------------------------------------|---------------------------------------------------------------------------------------------------------------------------------------------------------------------------------------------------------------------------------------------------------------------------------------------------------------------------------------------------------------------------------------------------------------------------------------------------------------------------------------------------------------------------------------------------------------------------------------------------------------------------------------------------------------------------------------------------------------------------------------------------------------------------------------------------------------------------------------------------------------------------------------------------------------------------------------------------------------------------------------------------------------------------------------------------------------------------------------------------------------------------------------------------------------------------------------------------------------------------------------|-------------------|-----|-----|-----|------|---|----|----|-------------------|-----|-----|-----|------|-----|---|---|
| <p>端子强度<br/>Terminal strength</p>       | <p>端子抗拉强度：沿电容器端子引线方向施加固定重力如下表 10 秒钟<br/>Tensile strength of terminal:A static load (stated in the table above) shall be applied to the terminal in the axial direction and acting in a direction away from the body for 10±1 sec.</p> <table border="1" data-bbox="432 488 1345 613"> <tr> <td>引线直径<br/><math>\varphi</math></td> <td>0.5</td> <td>0.6</td> <td>0.8</td> </tr> <tr> <td>拉力 N</td> <td>5</td> <td>10</td> <td>10</td> </tr> </table> <p>端子抗弯强度：在电容器引线施加固定重力如下表，然后，将电容器弯折 90° 后回到原位，再向相反方向弯折 90° 后回到原位。上述过程在 5 秒内完成。<br/>Hang the specified dead weight (stated in the table above), then bend the body through 90°, return to the original position. Next bend it in opposite direction through 90° with the same speed, again return to the original position.<br/>Complete this operation in about 5 sec.</p> <table border="1" data-bbox="432 904 1345 1030"> <tr> <td>引线直径<br/><math>\varphi</math></td> <td>0.5</td> <td>0.6</td> <td>0.8</td> </tr> <tr> <td>拉力 N</td> <td>2.5</td> <td>5</td> <td>5</td> </tr> </table> <p>测量电容器应无接触不良、开路或短路，无可见机械损伤<br/>When the capacitor is measured, there shall be no intermittent contacts, or open or short-circuiting. There shall be no visible mechanical damage.</p> | 引线直径<br>$\varphi$ | 0.5 | 0.6 | 0.8 | 拉力 N | 5 | 10 | 10 | 引线直径<br>$\varphi$ | 0.5 | 0.6 | 0.8 | 拉力 N | 2.5 | 5 | 5 |
| 引线直径<br>$\varphi$                       | 0.5                                                                                                                                                                                                                                                                                                                                                                                                                                                                                                                                                                                                                                                                                                                                                                                                                                                                                                                                                                                                                                                                                                                                                                                                                                   | 0.6               | 0.8 |     |     |      |   |    |    |                   |     |     |     |      |     |   |   |
| 拉力 N                                    | 5                                                                                                                                                                                                                                                                                                                                                                                                                                                                                                                                                                                                                                                                                                                                                                                                                                                                                                                                                                                                                                                                                                                                                                                                                                     | 10                | 10  |     |     |      |   |    |    |                   |     |     |     |      |     |   |   |
| 引线直径<br>$\varphi$                       | 0.5                                                                                                                                                                                                                                                                                                                                                                                                                                                                                                                                                                                                                                                                                                                                                                                                                                                                                                                                                                                                                                                                                                                                                                                                                                   | 0.6               | 0.8 |     |     |      |   |    |    |                   |     |     |     |      |     |   |   |
| 拉力 N                                    | 2.5                                                                                                                                                                                                                                                                                                                                                                                                                                                                                                                                                                                                                                                                                                                                                                                                                                                                                                                                                                                                                                                                                                                                                                                                                                   | 5                 | 5   |     |     |      |   |    |    |                   |     |     |     |      |     |   |   |
| <p>振动试验<br/>Resistance to vibration</p> | <p>依据 IEC60068-2-6 试验。According to the IEC60068-2-6 test.<br/>在 3 个互相垂直的方向分别施加 2 小时振动，共 6 小时，测量容量应无接触不良开路或短路<br/>Direction and duration of vibration: 3 orthogonal directions mutually each for 2h, Total 6h.<br/>When the capacitor is measured there shall be no intermittent contacts, or open or short circuiting There shall be no visible mechanical damage.</p>                                                                                                                                                                                                                                                                                                                                                                                                                                                                                                                                                                                                                                                                                                                                                                                                                                                                |                   |     |     |     |      |   |    |    |                   |     |     |     |      |     |   |   |
| <p>可焊性<br/>Weld ability</p>             | <p>依据 IEC60068-2-6 进行试验。焊锡温度：250±5℃；<br/>浸入时间：2±5 秒<br/>浸入焊锡的引线表面积约 3/4 以上应附著新锡<br/>According to the IEC60068-2-6 test.<br/>soldering temperature: 250±5℃；<br/>Dipping time: 2±5 秒<br/>At least 3/4 of circumferential surface of the dipping portion of terminal shall be covered with new solder.</p>                                                                                                                                                                                                                                                                                                                                                                                                                                                                                                                                                                                                                                                                                                                                                                                                                                                                                                                               |                   |     |     |     |      |   |    |    |                   |     |     |     |      |     |   |   |

|                                                                        |                         |
|------------------------------------------------------------------------|-------------------------|
| <b>Nantong Xingchen Electron Co. Ltd.<br/>Products Acknowledgement</b> | <b>Series: CD11RE</b>   |
| <b>外形尺寸 Outline Dimension</b>                                          | <b>Part C/ Aug,2017</b> |

一、1.外型尺寸 SIZE:

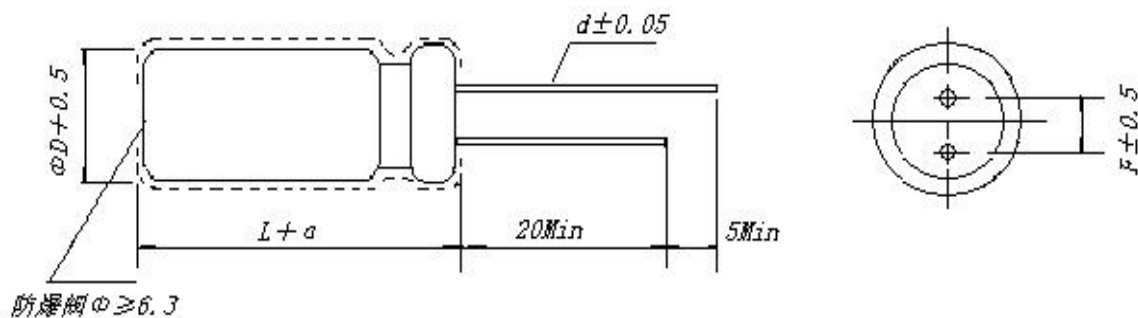

单位: mm

|          |     |     |     |      |      |     |
|----------|-----|-----|-----|------|------|-----|
| $\phi D$ | 10  | 10  | 10  | 12.5 | 12.5 | 16  |
| $\phi d$ | 0.6 | 0.6 | 0.6 | 0.6  | 0.6  | 0.8 |
| F        | 5.0 | 5.0 | 5.0 | 5.0  | 5.0  | 7.5 |
| L        | 12  | 16  | 20  | 20   | 25   | 30  |
| a        | 2.0 | 2.0 | 2.0 | 2.0  | 2.0  | 2.0 |

2. 纹波电流倍乘因子 RIPPLE CURRENT FREQUENCY COEFFICIENT

|        |      |      |      |      |
|--------|------|------|------|------|
| 频率     |      |      |      |      |
| 电压     | 120  | 1K   | 10K  | 100K |
| 25~50V | 0.50 | 0.80 | 0.90 | 1.00 |

|                                                                        |                         |
|------------------------------------------------------------------------|-------------------------|
| <b>Nantong Xingchen Electron Co. Ltd.<br/>Products Acknowledgement</b> | <b>Series: CD11RE</b>   |
| <b>技术参数 Technical Parameter</b>                                        | <b>Part C/ Aug,2017</b> |

## 一、 规格表 Specification table

| 产品内部料号<br>Internal material number<br>of the product | 规格<br>Specifications | 尺寸 size<br>(mm*mm) | 纹波电流<br>Ripple<br>current<br>(mA)<br>105°C 100KHz | 浪涌电压<br>(V) | 损耗值<br>Tanδ<br>(%) |
|------------------------------------------------------|----------------------|--------------------|---------------------------------------------------|-------------|--------------------|
| RRE331D1E10123P7BS00                                 | 25V330               | 10*12              | 800                                               | 31          | 14                 |
| RRE471D1E10163P7AS00                                 | 25V470               | 10*16              | 850                                               | 31          | 14                 |
| RRE102D1V12253P7AS00                                 | 35V1000              | 12.5*25            | 2100                                              | 44          | 12                 |
| RRE221D1H10163P7AS00                                 | 50V220               | 10*16              | 680                                               | 63          | 10                 |
| RRE331D1H10203P7AS00                                 | 50V330               | 10*20              | 1000                                              | 63          | 10                 |
| RRE471D1H12203P7AS00                                 | 50V470               | 12.5*20            | 1300                                              | 63          | 10                 |
| RRE102D1H16303P7AS00                                 | 50V1000              | 16*30              | 2660                                              | 63          | 10                 |

内部料号说明：例如

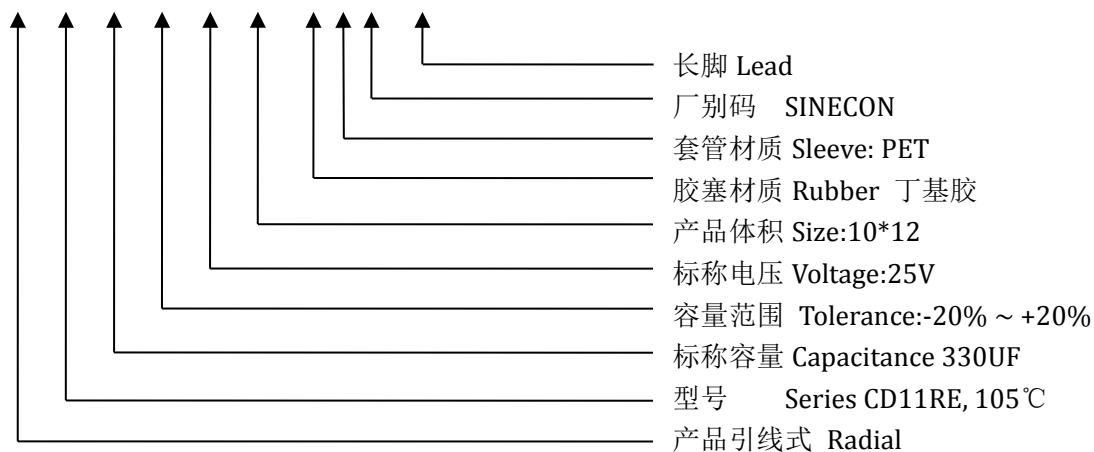
**R RE 330 D 1E 1012 3 P 7 BS00**

| Nantong Xingchen Electron Co. Ltd.<br>Products Acknowledgement |                              | Series: CD11RE                                             |                     |
|----------------------------------------------------------------|------------------------------|------------------------------------------------------------|---------------------|
| 主要材料清单 List Of Main Materials                                  |                              | Part C/ Aug,2017                                           |                     |
| 一、材料清单 List Of Materials                                       |                              |                                                            |                     |
| 项目                                                             | 原材料<br>Raw<br>material       | 供应商 Supplier                                               | 材质 material quality |
| 1                                                              | 阳极箔<br>Anode foil            | 南通海一电子有限公司<br>肇庆华锋电子铝箔股份有限公司<br>藤县加裕电子科技有限公司<br>扬州宏远科技有限公司 | 99.9%铝              |
| 2                                                              | 阴极箔<br>Cathode foil          | 吴江飞乐天电子材料有限公司<br>广东博罗冠业电子有限公司<br>湖北富奕达电子有限公司               | 99.8%铝              |
| 3                                                              | 引线<br>lead wire              | 南通金信电子有限公司<br>南通祯兴电子有限公司                                   | LG3/LG1             |
| 4                                                              | 电解纸<br>Electrolytic<br>paper | 浙江凯恩纸业有限公司<br>山东鲁南新材料股份有限公司                                | 双层复合                |
| 5                                                              | 铝壳<br>Aluminum<br>shell      | 奥星电子有限公司<br>如东联机电有限公司                                      | L1                  |
| 6                                                              | 胶塞<br>Rubber<br>stopper      | 玉环鑫庄电子有限公司<br>浙江天华电子有限公司<br>苏州毅丰橡胶工业有限公司                   | 丁基胶                 |
| 7                                                              | 套管<br>Rubber hose            | 顺鹏（苏州）有限公司<br>常州启扬塑胶有限公司<br>无等高新电子（无锡）有限公司                 | PET                 |

|                                                                        |                         |
|------------------------------------------------------------------------|-------------------------|
| <b>Nantong Xingchen Electron Co. Ltd.<br/>Products Acknowledgement</b> | <b>Series: CD11RE</b>   |
| <b>包装 Pack</b>                                                         | <b>Part C/ Aug,2017</b> |

一.成品包装标签 Finished packaging label

1. 包装标签：产品全线采用条形码标识（有料号组成）。特举例说明：  
Packaging labels: the product is marked by bar code (with material number).  
Special examples are as follows:

例如：RLH2R8V2G10164P5AK15 标签如下：



外箱标签 Outer box label

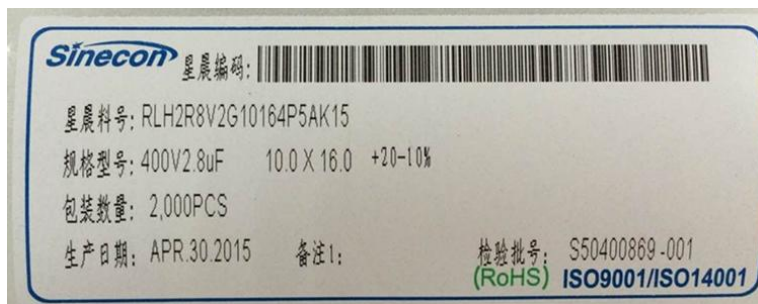

内盒标签 Inner box label

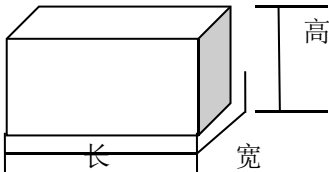
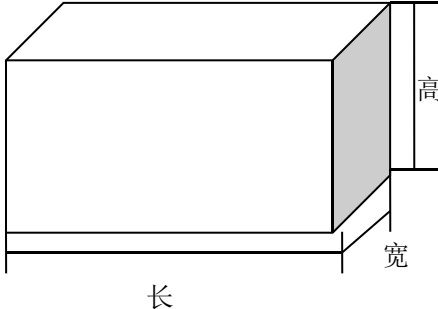

小袋标签 Pouch label

|                                                                                   |                    |                                                                                    |      |     |       |
|-----------------------------------------------------------------------------------|--------------------|------------------------------------------------------------------------------------|------|-----|-------|
| <b>Nantong Xingchen Electron Co. Ltd.</b><br><b>Products Acknowledgement</b>      |                    | <b>Series: CD11RE</b>                                                              |      |     |       |
| 包装 Pack                                                                           |                    | <b>Part C/ Aug,2017</b>                                                            |      |     |       |
| 2.包装箱尺寸 Packing box size:                                                         |                    |                                                                                    |      |     |       |
| 2.1 包装内盒及外箱尺寸 Packing box and outer box size                                      |                    |                                                                                    |      |     |       |
|  |                    |  |      |     |       |
| 项 目                                                                               | 内盒尺寸 (cm)<br>A*B*C | 外箱尺寸 (cm)<br>A*B*C                                                                 | 备注   |     |       |
| 中文箱                                                                               | 30*22*13.9         | 47*31.5*30                                                                         | 内销用  |     |       |
| 二: 包装数量清单 Packing quantity list                                                   |                    |                                                                                    |      |     |       |
| 壳号                                                                                | 只/袋                | 袋/盒                                                                                | 只/盒  | 盒/箱 | 只/箱   |
| 10*12                                                                             | 500                | 5                                                                                  | 2500 | 4   | 10000 |
| 10*16                                                                             | 500                | 4                                                                                  | 2000 | 4   | 8000  |
| 10*20                                                                             | 500                | 4                                                                                  | 2000 | 4   | 8000  |
| 12.5*20                                                                           | 200                | 5                                                                                  | 1000 | 4   | 4000  |
| 12.5*25                                                                           | 200                | 5                                                                                  | 1000 | 4   | 4000  |
| 16*30                                                                             | 100                | 5                                                                                  | 500  | 4   | 2000  |
| 注: ROHS 指令 (2002/95/EC) 已对应完毕                                                     |                    |                                                                                    |      |     |       |



|                                                                                                                                                                                                                                                                                                                                                                                                                                                                                                                                                                                                                                                                                                                                                                                                                                                                                                                                                                                                                                                                                                                                                                                                                                                                                                                                                                                                                                                                                                                                                                                                                                                                                                                                                                                                                                                                                                                                   |                         |
|-----------------------------------------------------------------------------------------------------------------------------------------------------------------------------------------------------------------------------------------------------------------------------------------------------------------------------------------------------------------------------------------------------------------------------------------------------------------------------------------------------------------------------------------------------------------------------------------------------------------------------------------------------------------------------------------------------------------------------------------------------------------------------------------------------------------------------------------------------------------------------------------------------------------------------------------------------------------------------------------------------------------------------------------------------------------------------------------------------------------------------------------------------------------------------------------------------------------------------------------------------------------------------------------------------------------------------------------------------------------------------------------------------------------------------------------------------------------------------------------------------------------------------------------------------------------------------------------------------------------------------------------------------------------------------------------------------------------------------------------------------------------------------------------------------------------------------------------------------------------------------------------------------------------------------------|-------------------------|
| <b>Nantong Xingchen Electron Co. Ltd.</b><br><b>Products Acknowledgement</b>                                                                                                                                                                                                                                                                                                                                                                                                                                                                                                                                                                                                                                                                                                                                                                                                                                                                                                                                                                                                                                                                                                                                                                                                                                                                                                                                                                                                                                                                                                                                                                                                                                                                                                                                                                                                                                                      | <b>Series: CD11RE</b>   |
| <b>标识 Characteristic</b>                                                                                                                                                                                                                                                                                                                                                                                                                                                                                                                                                                                                                                                                                                                                                                                                                                                                                                                                                                                                                                                                                                                                                                                                                                                                                                                                                                                                                                                                                                                                                                                                                                                                                                                                                                                                                                                                                                          | <b>Part C/ Aug,2017</b> |
| <p>一 标识 Identification :</p> <p>1、电容器上应清晰地标出 The following contents should be clearly marked on the capacitor;</p> <p>A、标称电容量;      B、工作电压;<br/> C、端极性;      D、使用温度; (-40℃~+105℃)<br/> E、商 标;      F、型号;<br/> G、线号 (例如 B-15 代表 2015 年 01.02 月份, D-15 代表 2015 年 03.04 月份等等)</p> <p>举例说明 :</p> <p>1、The following contents should be clearly marked on the capacitor;</p> <p>A、Nominal capacitance      B、 Rated voltage<br/> C、End polarity      D、Temperature range(-40℃~+105℃ )<br/> E、Trademark      F、 Model<br/> G、Line number (for example, B-15 represents 1.02 months in 2015, D-15 represents 2015 3.04 months, etc.)</p> <p>for example :</p> <div style="display: flex; justify-content: space-around; align-items: flex-start;"> <div style="text-align: center;">  <p>→ A</p> <p>→ C</p> <p>→ B</p> </div> <div style="text-align: center;">  <p>→ E</p> <p>→ F</p> <p>→ D</p> <p>→ G</p> </div> </div> <p>2、标记颜色      Marker color<br/> 套管颜色 : CD11RE-黑蓝      Casing color : Black blue<br/> 标记颜色 : 白      Marker color: White</p> <p>3、装有电容器的包装应明确注明产品型号、额定电压、标称电容量及允许偏差、电容器数量、生产厂名及商标、制造年月日。<br/> The packaging of capacitors should clearly indicate the product model, rated voltage, nominal capacitance and allowable deviation, quantity of capacitor, manufacturer's name and trademark, and date of manufacture.</p> <p>4、订货数据 Order data<br/> 按本详细规范生产的电容器在订货时应清楚地提供以下内容:</p> <p>a、标称电容量;<br/> b、电容量允许偏差;<br/> c、额定电压;<br/> d、本详细规范的代号和产品型号。</p> <p>The capacitors produced according to this detailed specification should clearly provide the following contents when ordering:</p> <p>a、Nominal capacitance<br/> b、Capacitance tolerance<br/> c、Rated voltage<br/> d、The code and product model of this detailed specification</p> |                         |

|                                                                                                                                                                                                                                                                                                                                                                                                                                                                                                                                                                                                                                                                                                                                                                                                                                                                                                                                                                                                                                                                                                                                                                                                                                                                                                                                                                                                                                                                                                                                                                                                                                                                                                                                                                                                                                                                                                                                                                                                                                                                                                                                                                                                                                                                                                                                                                                                                                                                                                                            |                                               |
|----------------------------------------------------------------------------------------------------------------------------------------------------------------------------------------------------------------------------------------------------------------------------------------------------------------------------------------------------------------------------------------------------------------------------------------------------------------------------------------------------------------------------------------------------------------------------------------------------------------------------------------------------------------------------------------------------------------------------------------------------------------------------------------------------------------------------------------------------------------------------------------------------------------------------------------------------------------------------------------------------------------------------------------------------------------------------------------------------------------------------------------------------------------------------------------------------------------------------------------------------------------------------------------------------------------------------------------------------------------------------------------------------------------------------------------------------------------------------------------------------------------------------------------------------------------------------------------------------------------------------------------------------------------------------------------------------------------------------------------------------------------------------------------------------------------------------------------------------------------------------------------------------------------------------------------------------------------------------------------------------------------------------------------------------------------------------------------------------------------------------------------------------------------------------------------------------------------------------------------------------------------------------------------------------------------------------------------------------------------------------------------------------------------------------------------------------------------------------------------------------------------------------|-----------------------------------------------|
| <p align="center"><b>Nantong Xingchen Electron Co. Ltd.</b><br/><b>Products Acknowledgement</b></p>                                                                                                                                                                                                                                                                                                                                                                                                                                                                                                                                                                                                                                                                                                                                                                                                                                                                                                                                                                                                                                                                                                                                                                                                                                                                                                                                                                                                                                                                                                                                                                                                                                                                                                                                                                                                                                                                                                                                                                                                                                                                                                                                                                                                                                                                                                                                                                                                                        | <p align="center"><b>Series: CD11RE</b></p>   |
| <p align="center">使用注意事项 <b>Notice Of Use</b></p>                                                                                                                                                                                                                                                                                                                                                                                                                                                                                                                                                                                                                                                                                                                                                                                                                                                                                                                                                                                                                                                                                                                                                                                                                                                                                                                                                                                                                                                                                                                                                                                                                                                                                                                                                                                                                                                                                                                                                                                                                                                                                                                                                                                                                                                                                                                                                                                                                                                                          | <p align="center"><b>Part C/ Aug,2017</b></p> |
| <p align="center"><b>其它说明 OTHER REMARKS</b></p> <p><b>一.铝电解电容器使用注意事项 IMPORTANT INFORMATION ON THE APPLICATION OF ALUMINUM ELECTROLYTIC CAPACITORS</b></p> <p>1. 直流铝电解电容器应按正确的极性使用 DC aluminum electrolytic capacitors are normally polarized<br/>当直流铝电解电容器按反极性接入电路时，电容器会导致电子线路短路，由此产生的电流会引致电容器损坏。若电路中有可能在负引线施加正极电压，请选择无极性产品。<br/>When reverse voltage is applied on DC aluminum electrolytic capacitor ,the circuit will be short out and the capacitor will be damaged due to abnormal current flows through the capacitor. Please use non- polar types of capacitors when the positive voltage is applied on the cathode terminal.</p> <p>2. 在额定工作电压以下作用 Use capacitor within rated voltage<br/>当电容器上所施加电压高于额定工作电压时，电容器的漏电流将上升，其电气特性将在短时间内劣化直至损坏。请注意电压峰值勿超出额定工作电压。<br/>When capacitor is used at higher voltage than the rated voltage, leakage current may increase and characteristics may be drastically deteriorated and damaged in a short period. Please take extra caution that the peak voltage should not exceed the rated voltage.</p> <p>3 作快速充放电使用 Sudden charge and discharge<br/>当常规电容器被用作快速充放电用途，其使用寿命可能因为容量下降，温度急剧上升等而缩减<br/>When aluminum electrolytic capacitors for general purpose-use are employed in rapid charge and discharge application, its life expectancy may be shortened resulted from capacitance decrease,heat rise, etc.</p> <p>4 电容器贮存 Storage of the capacitor<br/>当铝电解电容器作了长期贮存后，其漏电流通常升高，贮存温度愈高，漏电流上升愈快。因此应注意贮存环境的选择，在电容器施加电压后，漏电流值将不断下降。在铝电解电容器的漏电流值上升对电路有不良影响的，请在使用前充电处理。<br/>When the aluminum electrolytic capacitor is stored for a long time, its leakage current usually increases. The higher the storage temperature, the faster the leakage current rises. Therefore, attention should be paid to the selection of storage environment, and the leakage current value will continue to decrease after the capacitor is applied. If the leakage current of the aluminum electrolytic capacitor has a negative effect on the circuit, please charge it before use.</p> <p>5 施加纹波电流应小于额定值 capacitor within rated ripple current<br/>施加纹波电流超过额定值后，会导致电容器体过热，容量下降，寿命缩短。电容器上标注了额定电压，请将和直流电压叠加的纹波电压的峰值控制在额定工作电压以下。<br/>If excessive ripple current is applied on the capacitor, excessive heat will be generated inside,the capacitance will be reduced and capacitor's life shall be shortened. Rated voltage has been marked on the capacitor; therefore, the peak value of the ripple voltage should be less than the rated voltage.</p> <p>6 使用环境温度 Ambient temperature</p> |                                               |

铝电解电容器的使用寿命会受到环境温度的影响，使用环境温度下降 10℃ 其使用寿命增加 1 倍。

Life of aluminum electrolytic capacitor is affected by the ambient temperature. It is generally known that the life doubles for each 10℃ decrease in temperature.

#### 7 引出线强度 Tensile strength of lead wire

当拉力施加到电容器引出线，该拉力将作用于电容器内部，这将导致电容器内部短路，开路或漏电流上升。在电容器焊装到电路板，请勿强烈摇动电容器。

When a strong force is applied to the lead wires or terminals, stress is put on the internal connections, which may result in short circuit, open circuit or leakage current increase. Therefore it is not advisable to bend or handle a capacitor after it has been soldered to the PC board.

#### 8 焊接过程耐热性 Heat resistance at the soldering process

铝电解电容器装至电路板进行焊接或波焊时，其塑料套管可能因焊接时间过长、温度过高而发生二次收缩。

During soldering process, secondary shrinkage or sleeve crack may occur when soldering temperature is too high or soldering time is too long.

#### 9 电路板的安装孔空距及安装位置 Hole pitch and position of PC board

电路板安装孔的设计与产品说明书的引脚距离相一致，如果将电容器强行插入孔距不配套的电路板，那么会有应力作用于引出线，这将导致短路或漏电流上升。

When designig a PC board , its hole pitch should be designed to coincide with the lead pitch (lead spacing) of the capacitor specified in the catalog or specifications. When a capacitor is forcibly inserted into an unmatched hole pitch, a force will put on the leads and which could result in a short circuit or increased leakage current.

二. 本产品（包括所有构件）完全符合欧盟 RoHS 要求，即 6 种有害物质的最大含量均不超过如下要求：

This product (including all components) is fully in line with EU RoHS requirements, that is, the maximum content of 6 harmful substances does not exceed the following requirements:

Cd（镉）-5ppM

Pb（铅）-30ppM

Hg（汞）-2ppM

Cr（6 价铬）-20ppM

PBB（多溴联苯）-10ppM

PCB（多氯联苯）-10ppM