

Data sheet

Commercial Art.No.: 78.210.4229.0

Module frame MOD MRG 16

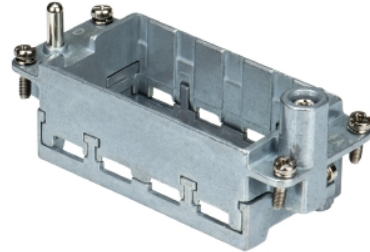

Commercial Art.No.	78.210.4229.0
EAN	4049088381430
Order Unit	5

Technical data

Classification

ECLASS 11	
ECLASS 8.1	27440206
ETIM 7.0	EC002312
ETIM 6.0	EC002312
ETIM 5.0	EC002312
ETIM 4.0	EC002312

Product compliance

REACH-SVHC conformity status	Compliant
------------------------------	-----------

A
 Weitergabe sowie Vervielfältigung dieses Dokuments, Verwertung und Mitteilung seines Inhalts sind verboten, soweit nicht ausdrücklich gestattet.
 The reproduction, distribution and utilization of this document as well as the communication of its contents to others without express authorization is prohibited.

B
 These dimensions will be especially checked at delivery
 Only inspection dimensions
 With /E marked dimensions are only valid for internal use

C
 Diese Maße werden bei Abnahme besonders geprüft
 Ausschließlich Prüfmaße
 Mit /E gekennzeichnete Maße sind nur für interne Zwecke gültig

F
 PE-contact max. 0,3Ω Power side signal side
 Anschlussquerschnitt 4-10qmm 1-2,5qmm
 cross section range AWG 12-8 AWG 18-14

gezeichnet / drawn 78.210.4329.0
 Größe / size 24 / A - F

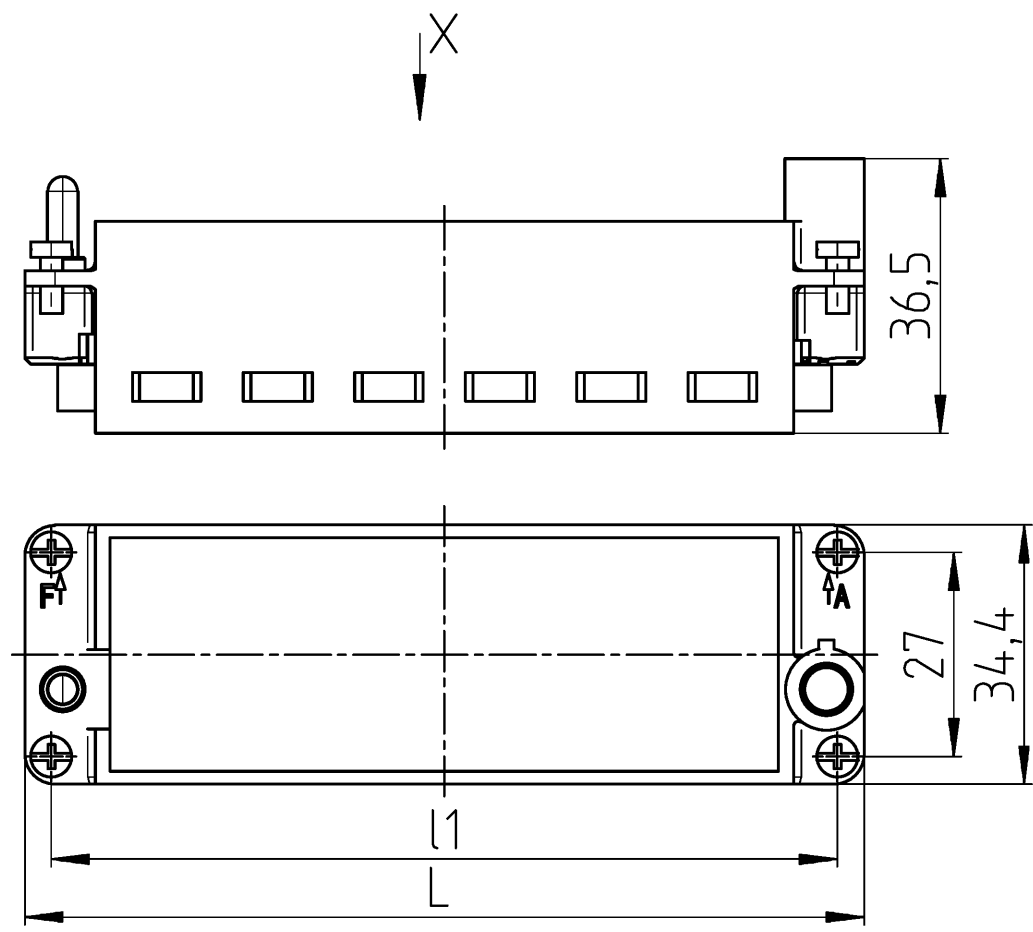

Technische Daten / technical data

PE-contact max. 0,3Ω	Power side	signal side
Anschlussquerschnitt cross section range	4-10qmm AWG 12-8	1-2,5qmm AWG 18-14

Ansicht / view X

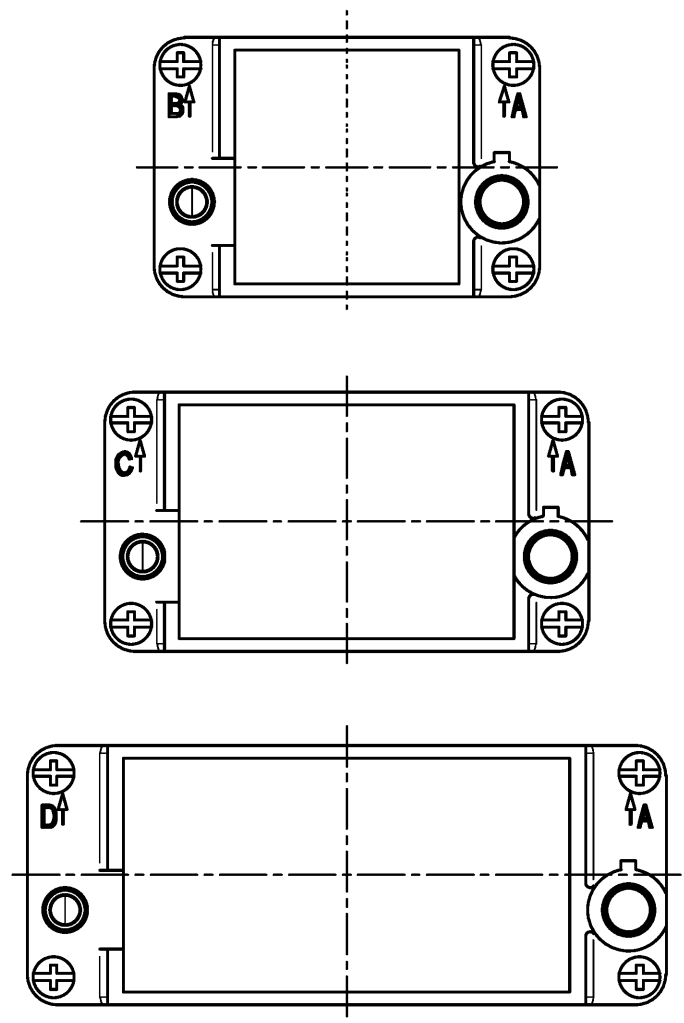

78.210.4029.0
 Größe / size 6 / A - B

78.210.4129.0
 Größe / size 10 / A - C

78.210.4229.0
 Größe / size 16 / A - D

Bestell - Nr. order - no.	Type	L	l1	Anwendung application
78.210.4029.0	MOD MRG 6	51	44	for 2 modules
78.210.4129.0	MOD MRG 10	64	57	for 3 modules
78.210.4229.0	MOD MRG 16	84,5	77,5	for 4 modules
78.210.4329.0	MOD MRG 24	111	104	for 6 modules

Weitere Daten siehe KATALOG oder eKATALOG.
 Additional data see CATALOG or eCATALOG.

www.wieland-electric.com
 eshop.wieland-electric.com

Tolerierung Size ISO 14405 © / Tolerance system Size ISO 14405 ©.
 (This ISO-standard describes the envelope principle. According to the envelope principle the deviations of form and parallelism are limited by the size tolerances).
 ja/yes Stoffverbots- und Deklarationsliste nach WN 5020.010 ist einzuhalten.
 Conformity with Wieland document WN 5020.010 e (list of prohibited / declarable hazardous substances) to be declared!

Freitoleranz nach General tolerance DIN ISO 2768 - m CAD - Zeichnung, keine manuellen Änderungen CAD - drawing, no manual modifications allowed 1 Verwendung: First Use: Blatt: 1 von 1 Sheet: of 1

	/	Werkstoff / Material Zink-Druckguß zinc die-cast	Tag/Date 03.08.2016	Name Duetsch T.	Zeichnung Nr. / Drawing No. T 78.210.4029.0 13K	Index a
	/	Maßstab / Scale 1:1	gezeichnet drawn		Maße in mm / Dimensions are in mm	
	/	Vol. mm³ Dfl./Srf. mm²	geprüft checked		Ersatz für / Replacement for:	
	/		Normgepr. Stand. check		Type MOD MRG	
	/				Benennung/Title MODULRAHMEN frame size 6 - 10 - 16 - 24 A - ...	
a	22.10.2019 /	www.wieland www.wieland-electric.com				
Index	Datum / Blatt Date / Sheet					
Änderung / Revision						