

DETAILS

Product Number	CA11416_STRADA-T-DN
Family	Strada-T
Type	Assembly
Color	clear
Diameter	19,8 x 15,5 mm
Height	8,75 mm
Style	rectang
Optic Material	PMMA
Holder Material	
Fastening	tape, pin, screw
Status	production ready
ROHS Compliant	Yes
Date Updated	12/01/2017



OPTICAL PROPERTIES

LED	Viewing Angle	Light Beam	Efficiency	cd/lm	Connector
XP-E	Asymmetric deg	Streetligh...	92 %	-	-
XP-G	Asymmetric deg	Streetligh...	92 %	-	-
XB-D	Asymmetric deg	Streetligh...	91 %	-	-
H35C0 (LEMWA33)	Asymmetric deg	Streetligh...	89 %	0.490	-
H35B0 (LEMWA32)	Asymmetric deg	Streetligh...	91 %	0.500	-
LUXEON Rebel	Asymmetric deg	Streetligh...	92 %	-	-
LUXEON Rebel ES	Asymmetric deg	Streetligh...	92 %	-	-
LUXEON A	Asymmetric deg	Streetligh...	92 %	-	-
LUXEON T	sim: Asymmetric	Streetligh...	sim: 91 %	-	-
LUXEON Z ES	Asymmetric deg	Streetligh...	90 %	0.500	-
LUXEON TX	Asymmetric deg	Streetligh...	91 %	0.500	-
NCSxx19A	Asymmetric deg	Streetligh...	92 %	-	-
NVSxx19A	Asymmetric deg	Streetligh...	92 %	-	-
NVSxx19B/NVSxx19C	sim: Asym	Streetligh...	sim: 90 %	-	-
Oslon SSL 80	Asymmetric deg	Streetligh...	92 %	-	-
Oslon SSL 150	Asymmetric deg	Streetligh...	92 %	-	-
Oslon Square PC	Asymmetric deg	Streetligh...	93 %	-	-
Z5	Asymmetric deg	Streetligh...	92 %	sim: 0.650	-
Z5M1/Z5M2	Asymmetric deg	Streetligh...	92 %	0.500	-
Double Dome (GM2BB)	Asymmetric deg	Streetligh...	92 %	-	-

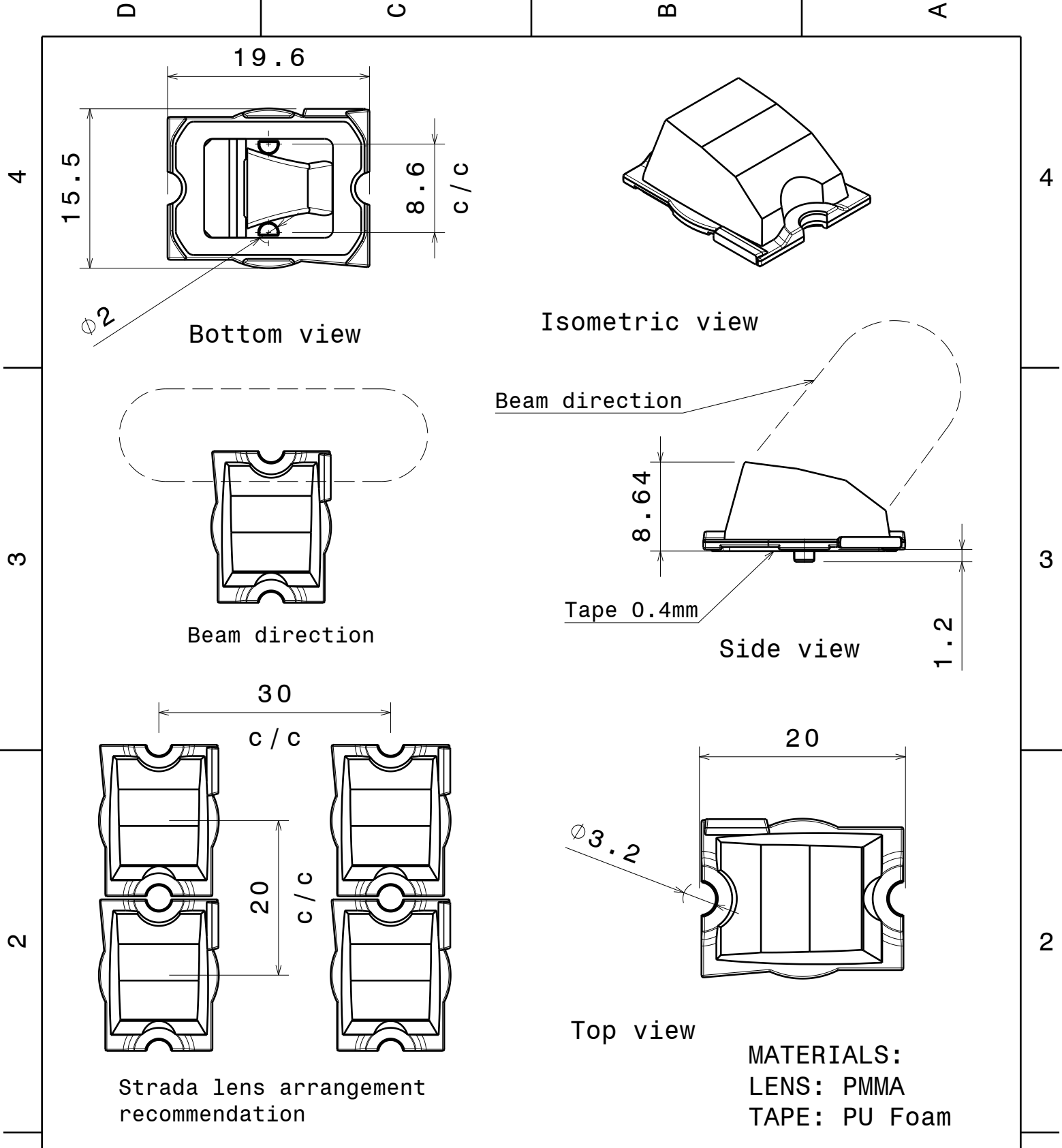

Tolerances if not otherwise shown
 According to DIN ISO 2768-1
 Linear measures: class C
 According to DIN ISO 2768-2
 Form and position: class L

LEDiL LediL Oy
 Salorankatu 10
 FIN 24240 SALO
 Finland

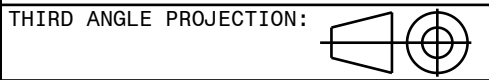

DRAWING TITLE
CA11416_STRADA-T-DN

This drawing is the property of LEDiL Oy. It may not be reproduced, copied or communicated without a written agreement with LEDiL Oy."

SIZE	PART NUMBER
A4	CA11416

SCALE	2:1	WEIGHT	1,31 g	SHEET	1/1
-------	-----	--------	--------	-------	-----

Ledil Oy C11415_Strada-T-DN-XP C11415_Strada-T-DN-XP / LDC (Linear)

Luminaire: Ledil Oy C11415_Strada-T-DN-XP C11415_Strada-T-DN-XP
Lamps: 1 x Cree XP-E (White)

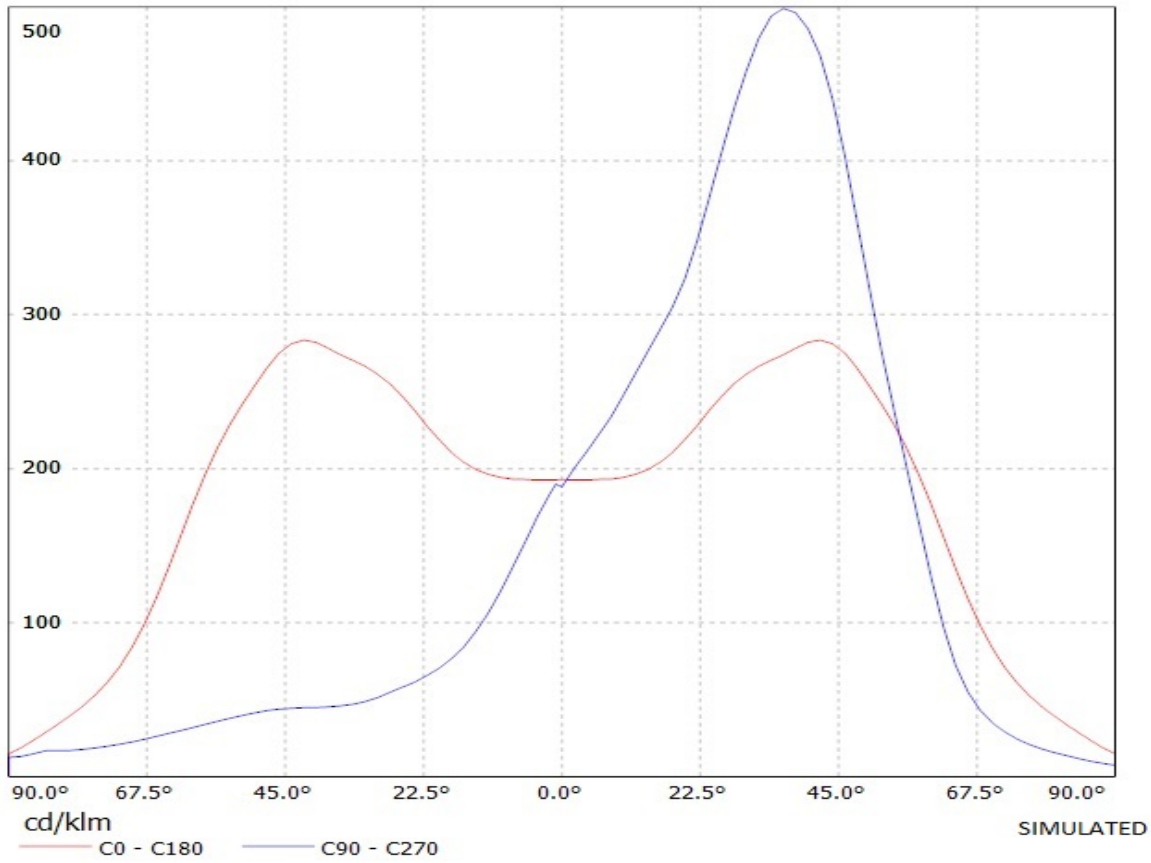

Ledil Oy C11415_Strada-T-DN-XP-G C11415_Strada-T-DN-XP-G / LDC (Linear)

Luminaire: Ledil Oy C11415_Strada-T-DN-XP-G C11415_Strada-T-DN-XP-G
Lamps: 1 x Cree XP-G (White)

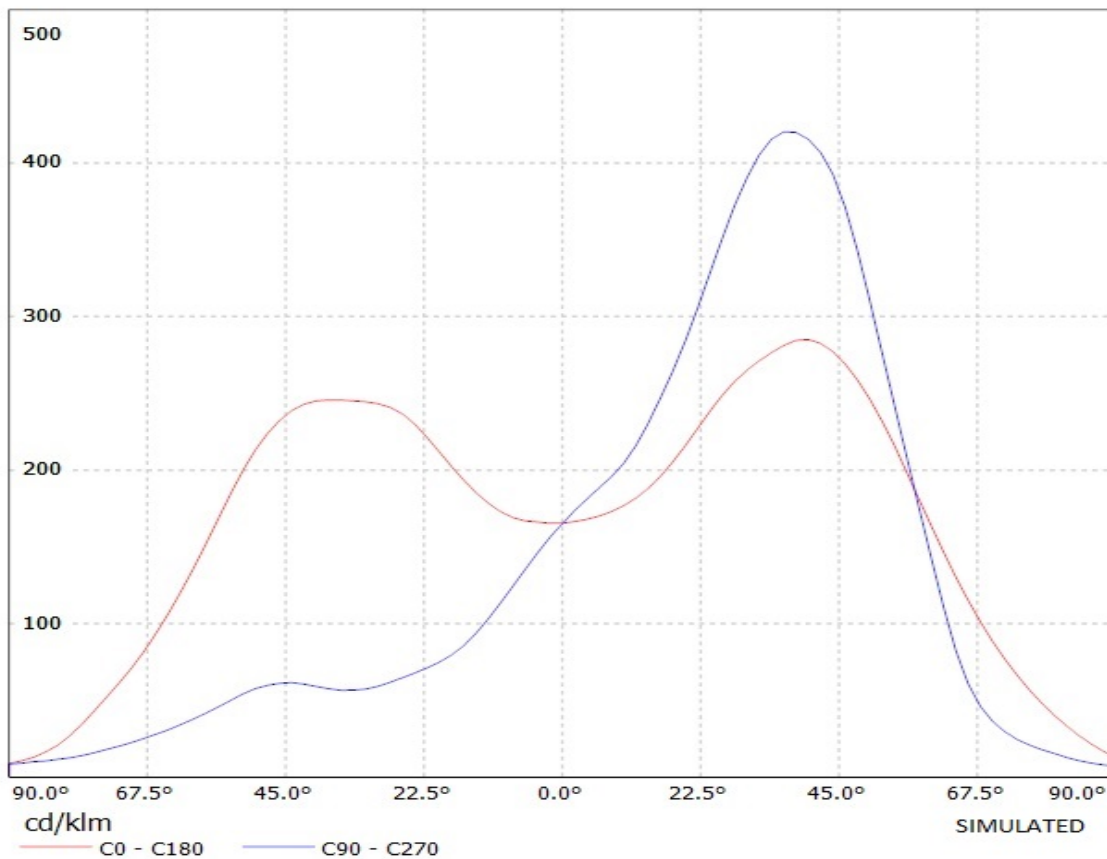

Luminaire: LEDiL Oy CA11416_STRADA-T-DN_(LG3535) Eff. 89,1%

Lamps: 1 x LG Ceramic 3535 PKG (95lm@250mA)

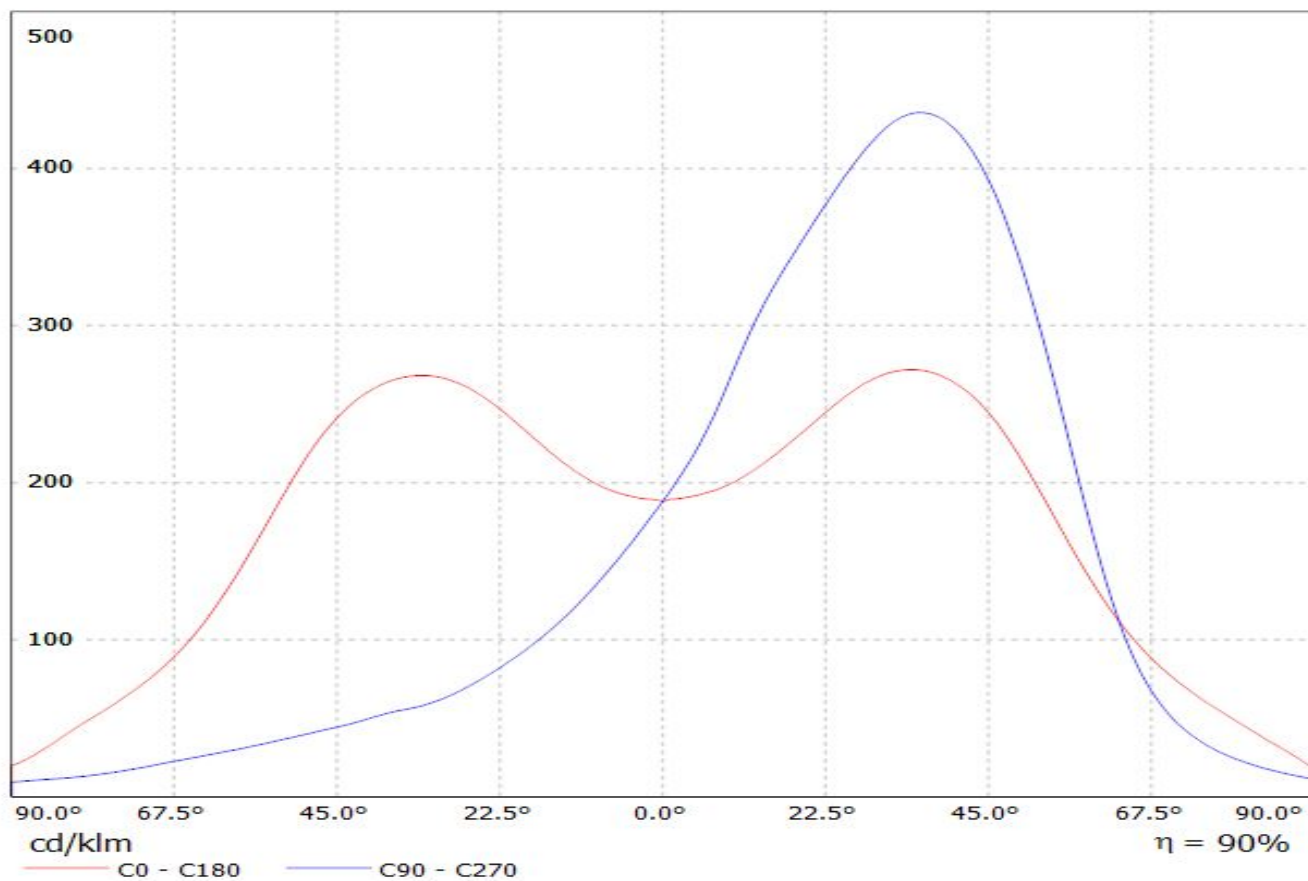

LEDiL Oy CA11416_STRADA-T-DN_(LG3535_2W) Eff.90.8% / LDC (Linear)

Luminaire: LEDiL Oy CA11416_STRADA-T-DN_(LG3535_2W) Eff.90.8%

Lamps: 1 x LG3535_2W (97.3629lm@250mA)

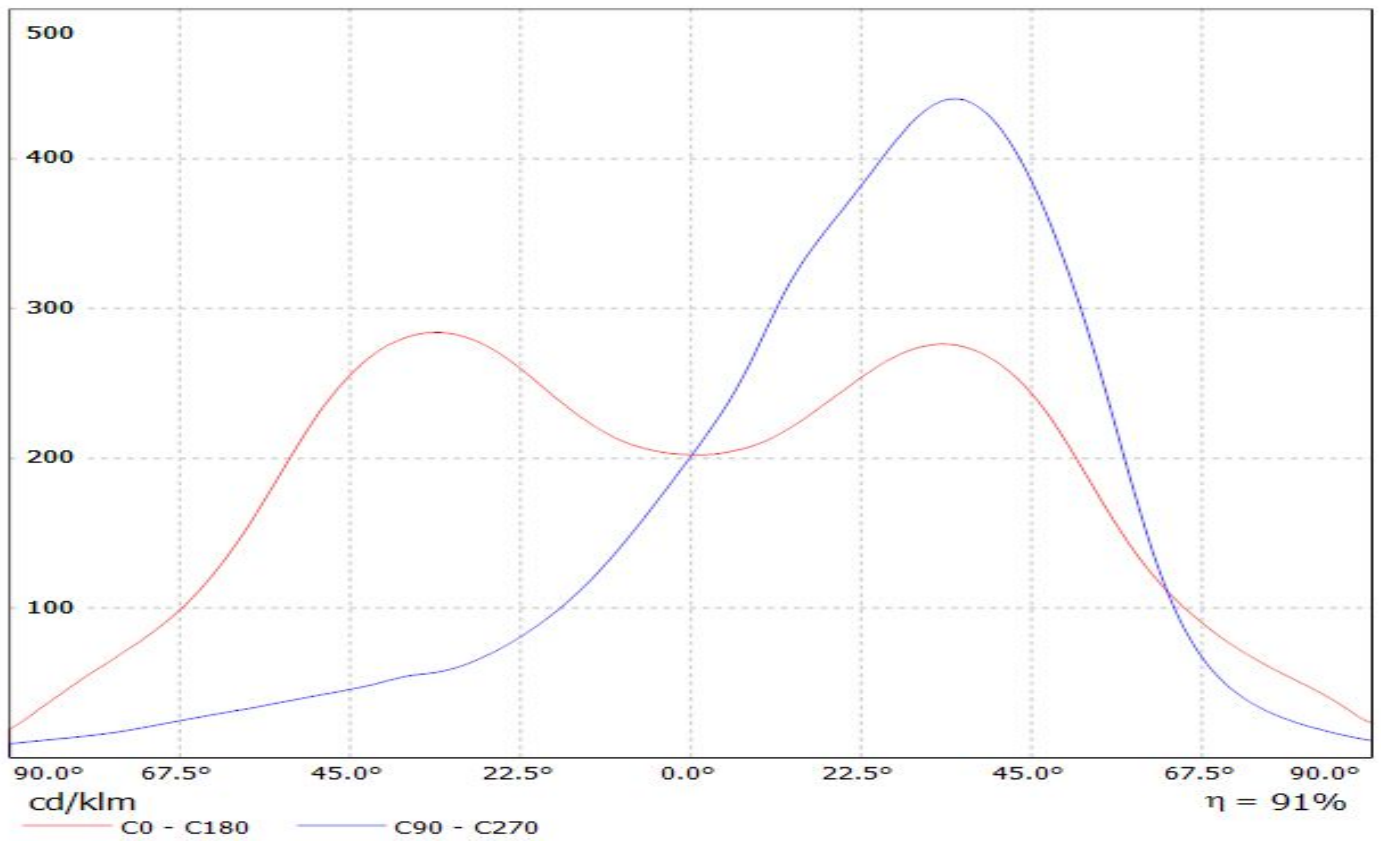

Ledil Oy C11415_Strada-T-DN-RE C11415_Strada-T-DN-RE / LDC (Linear)

Luminaire: Ledil Oy C11415_Strada-T-DN-RE C11415_Strada-T-DN-RE
Lamps: 1 x Luxeon Rebel (warm white)

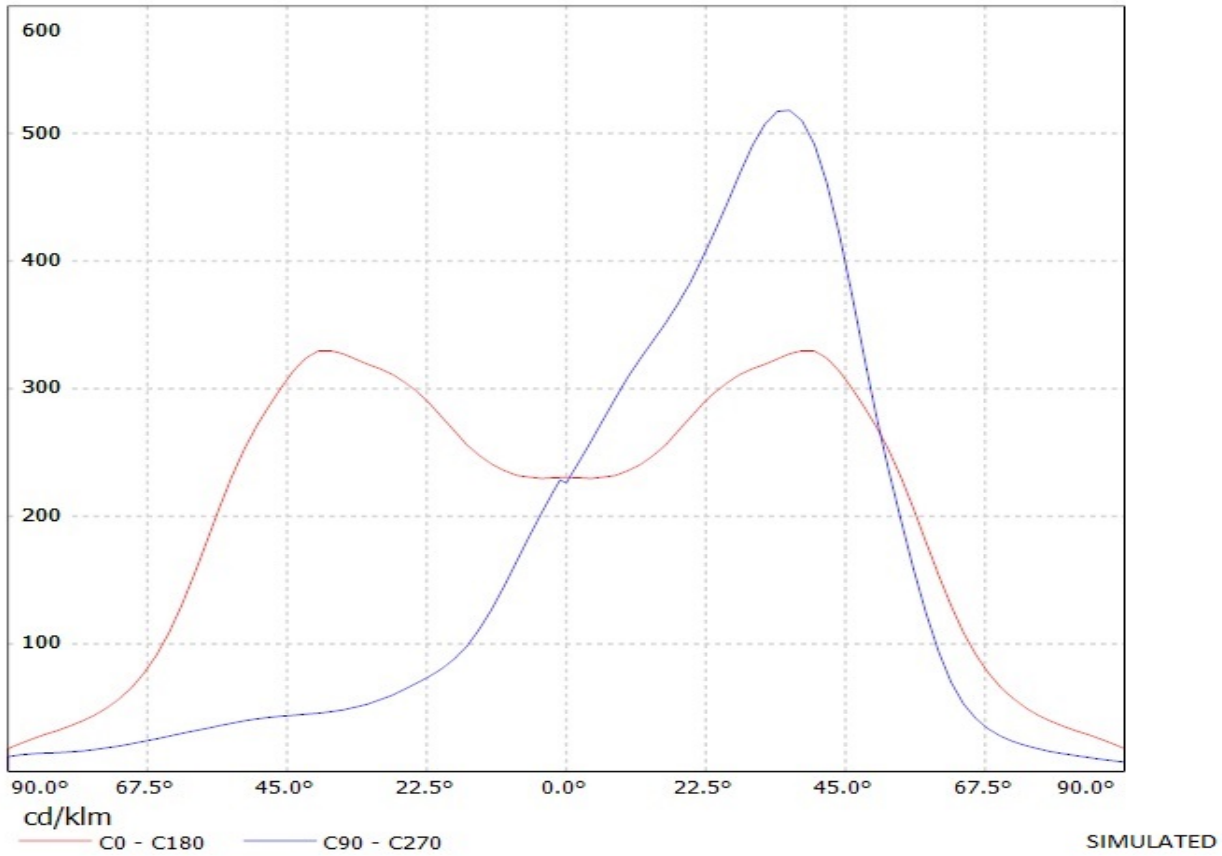

Ledil Oy C11415_Strada-T-DN-RE-ES C11415_Strada-T-DN-RE-ES / LDC (Linear)

Luminaire: Ledil Oy C11415_Strada-T-DN-RE-ES C11415_Strada-T-DN-RE-ES
Lamps: 1 x Luxeon Rebel ES (white)

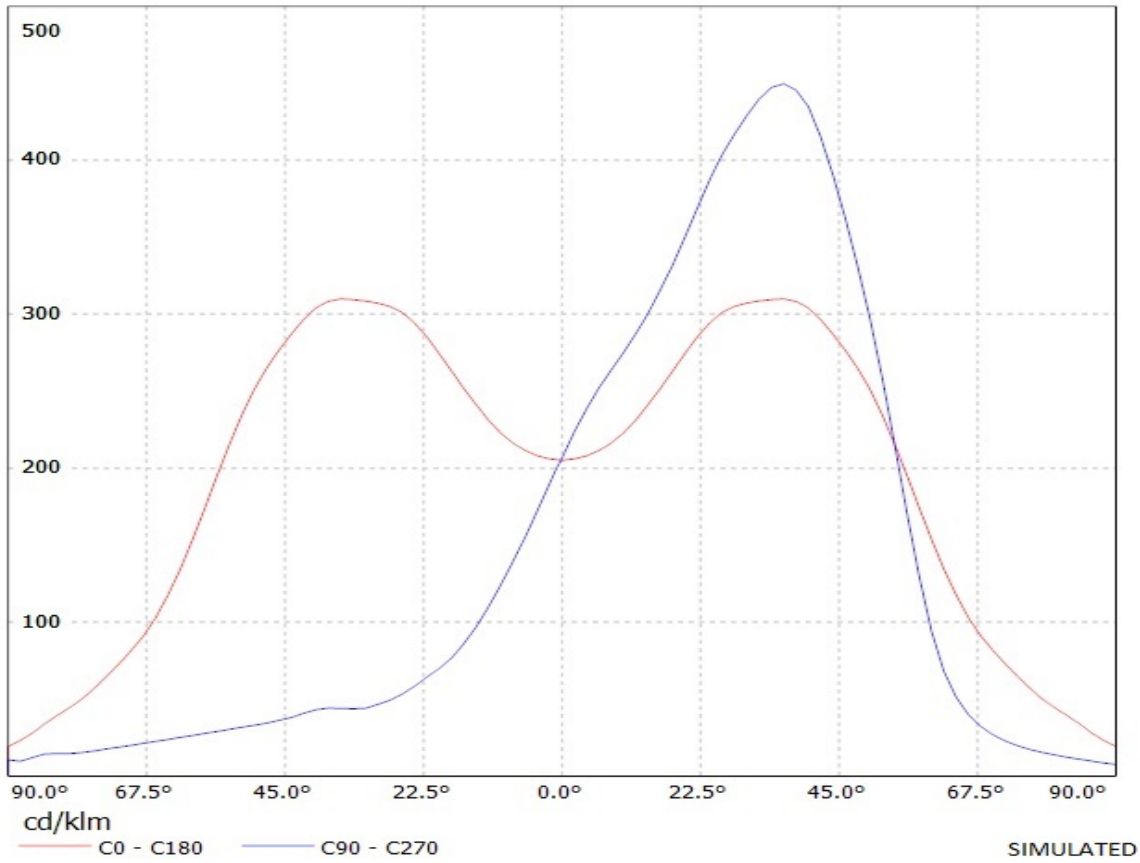

Luminaire: Ledil Oy CA11416_STRADA-T-DN_Luxeon-T_SIMULATED
Lamps: 1 x Luxeon T 100lm

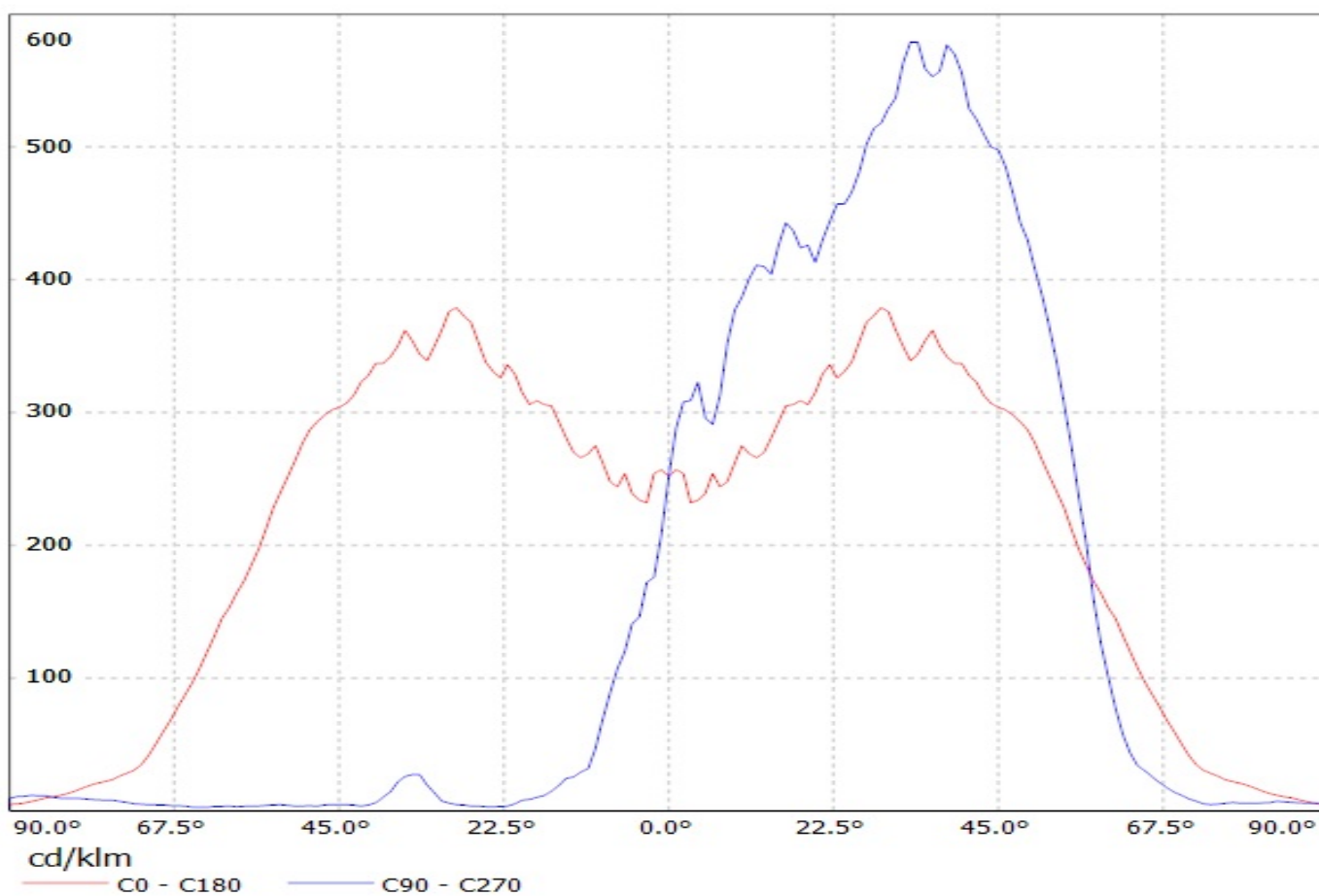

Luminaire: LEDiL Oy CA11416_STRADA-T-DN_(Luxeon_Z_ES) Eff.90.3%
Lamps: 1 x Luxeon_Z_ES_(LXZ2-3090)_50.8881lm@250mA_P=0.730433W_I=249.9mA

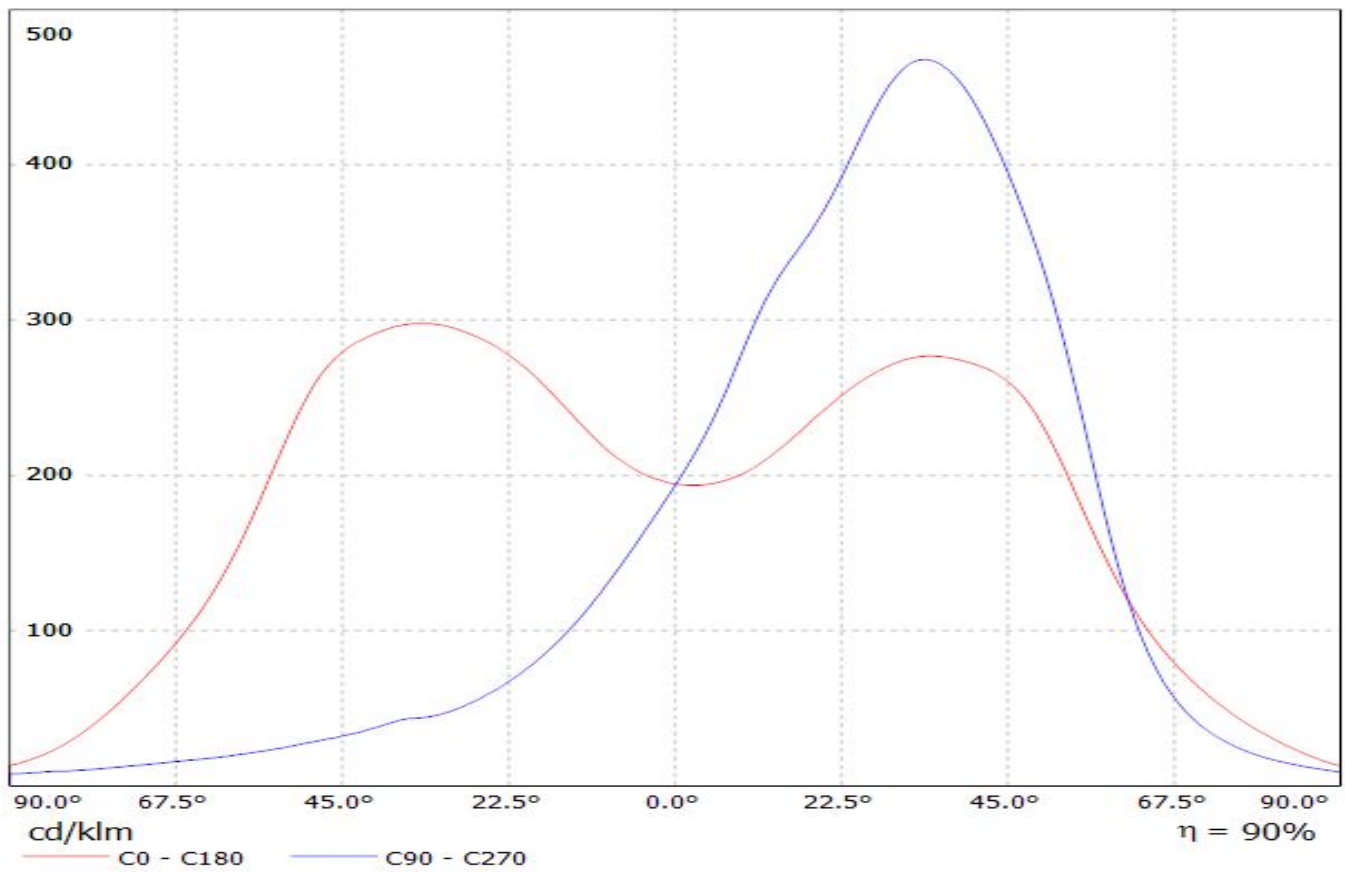

Luminaire: LEDiL Oy CA11416_STRADA-T-DN_(Luxeon_TX) Eff.91.2%
Lamps: 1 x Luxeon_TX_(L1T2-3585)_80.2531lm@250mA_CCT=3500K_P=0.730933W_I=249.9mA

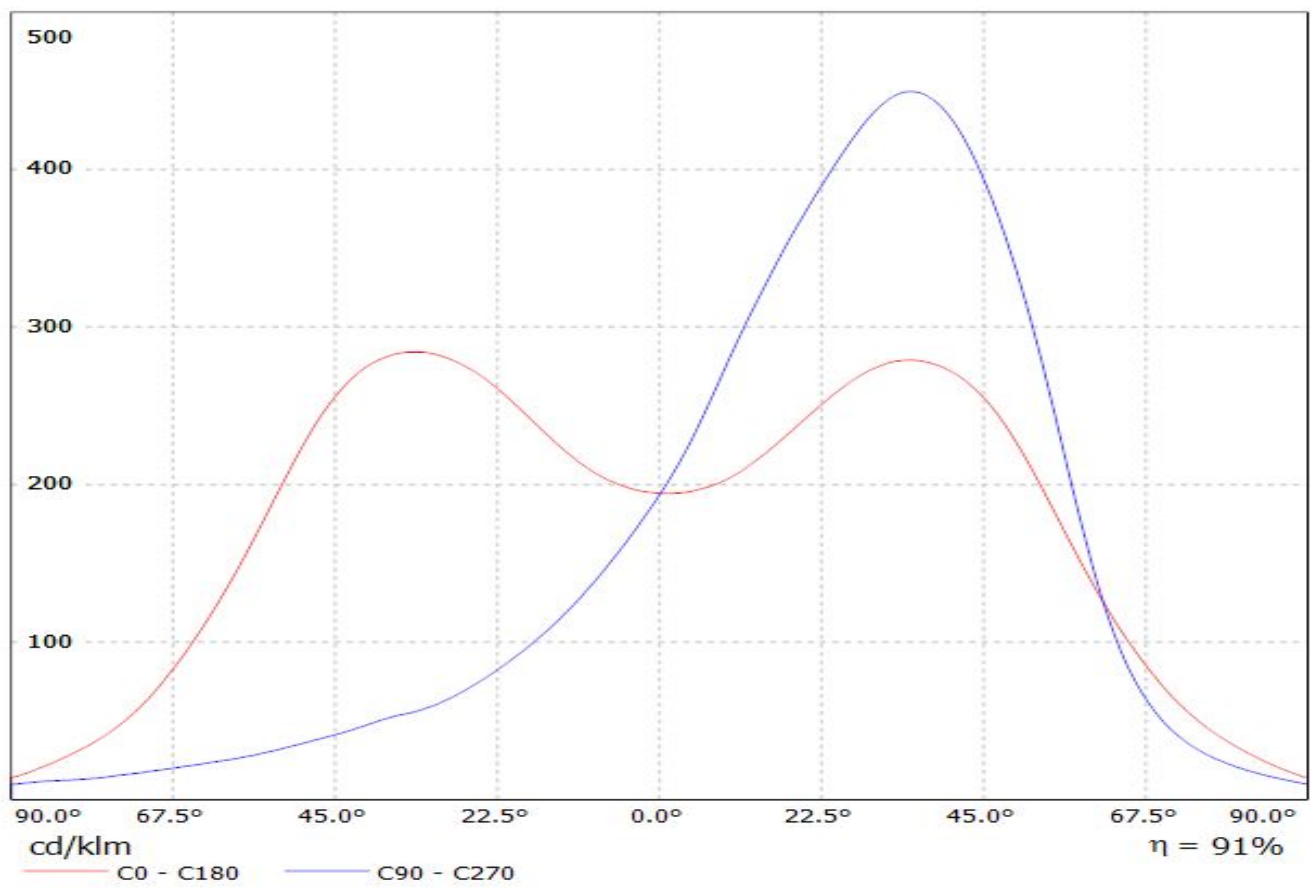

Ledil Oy C11415_Strada-T-DN-OSL C11415_Strada-T-DN-OSL / LDC (Linear)

Luminaire: Ledil Oy C11415_Strada-T-DN-OSL C11415_Strada-T-DN-OSL
Lamps: 1 x Osram Oslon SSL (White)

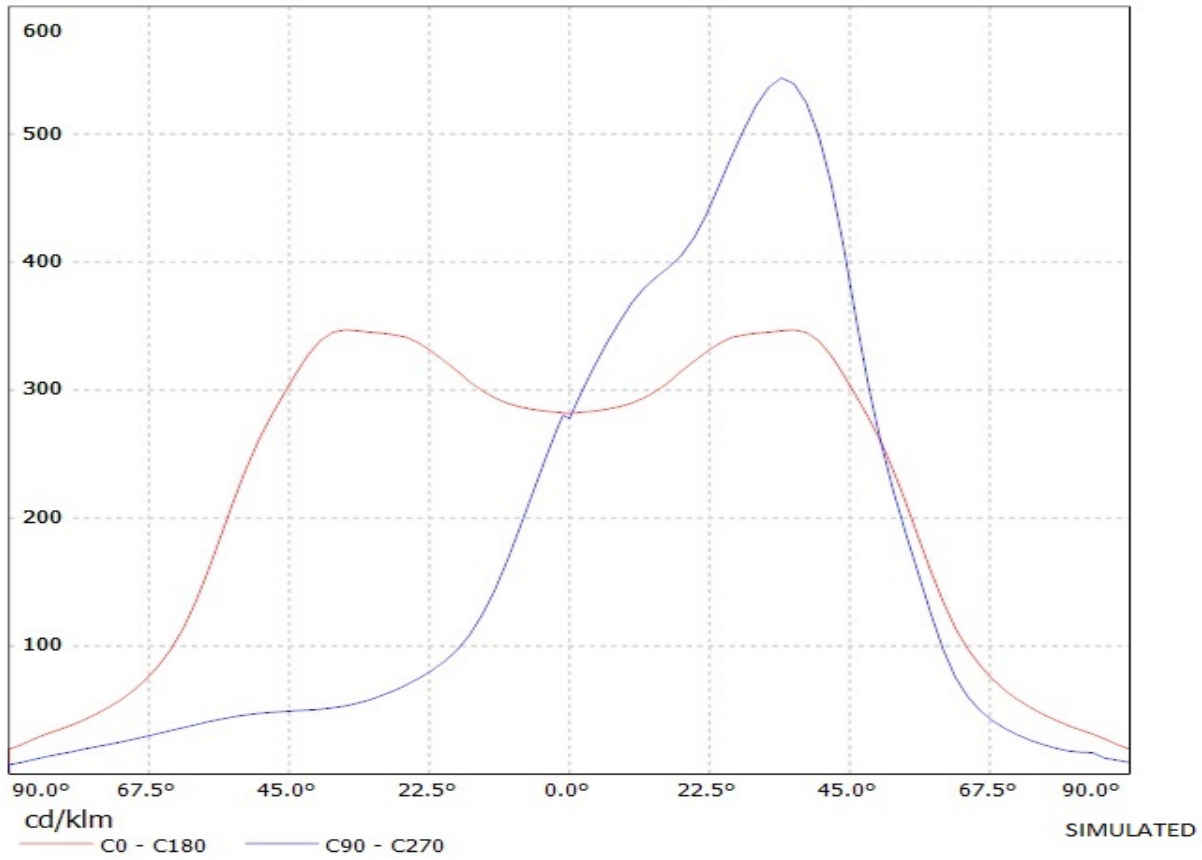

Luminaire: LEDIL OY C11415_STRADA-T-DN / CA11416_STRADA-T-DN (SQ PC) Efficiency=93%
Lamps: 1 x Osram Oslon Square PC (93lm@250mA)

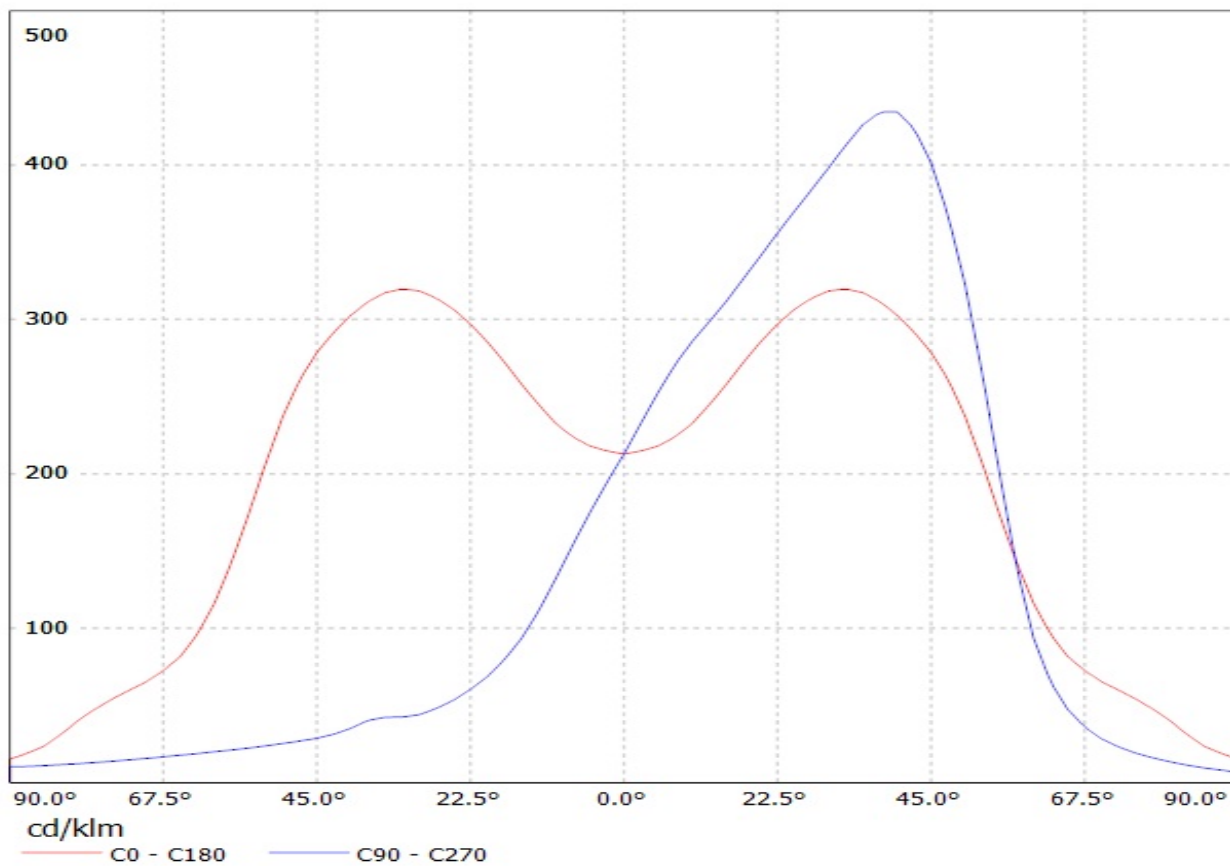

Luminaire: Ledil Oy CA11416_STRADA-T-DN_(Z5)_SIMULATED
Lamps: 1 x Seoul Z5 (SZW05A0B)

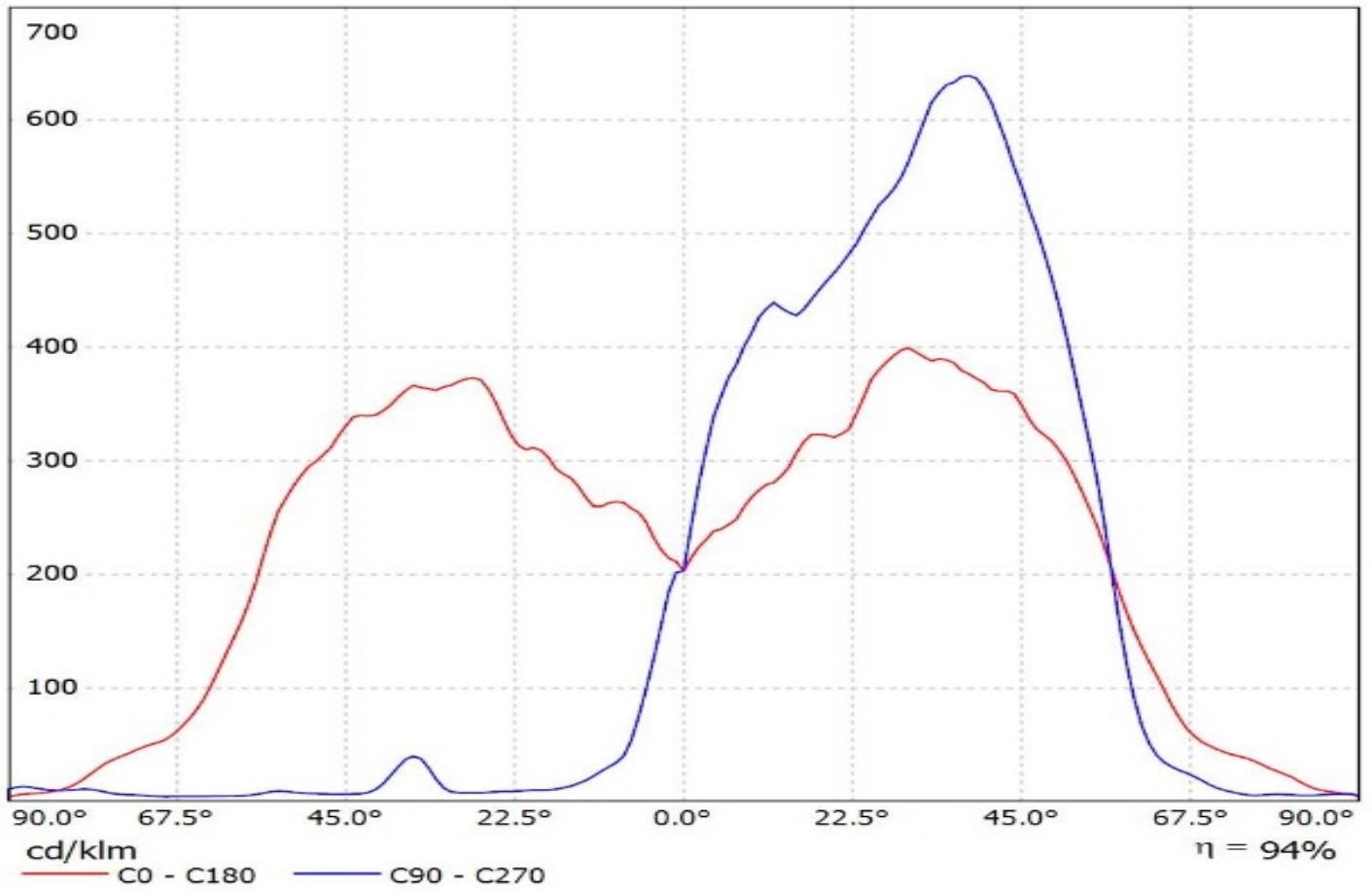

Luminaire: LEDil Oy CA11416_STRADA-T-DN_(Z5M1) Efficiency=92%

Lamps: 1 x Seoul Z5M1 (SZ5M1-W0-C8/W1-A5-G) 108lm @ 250mA CCT=9100K P=0.8W I=250mA

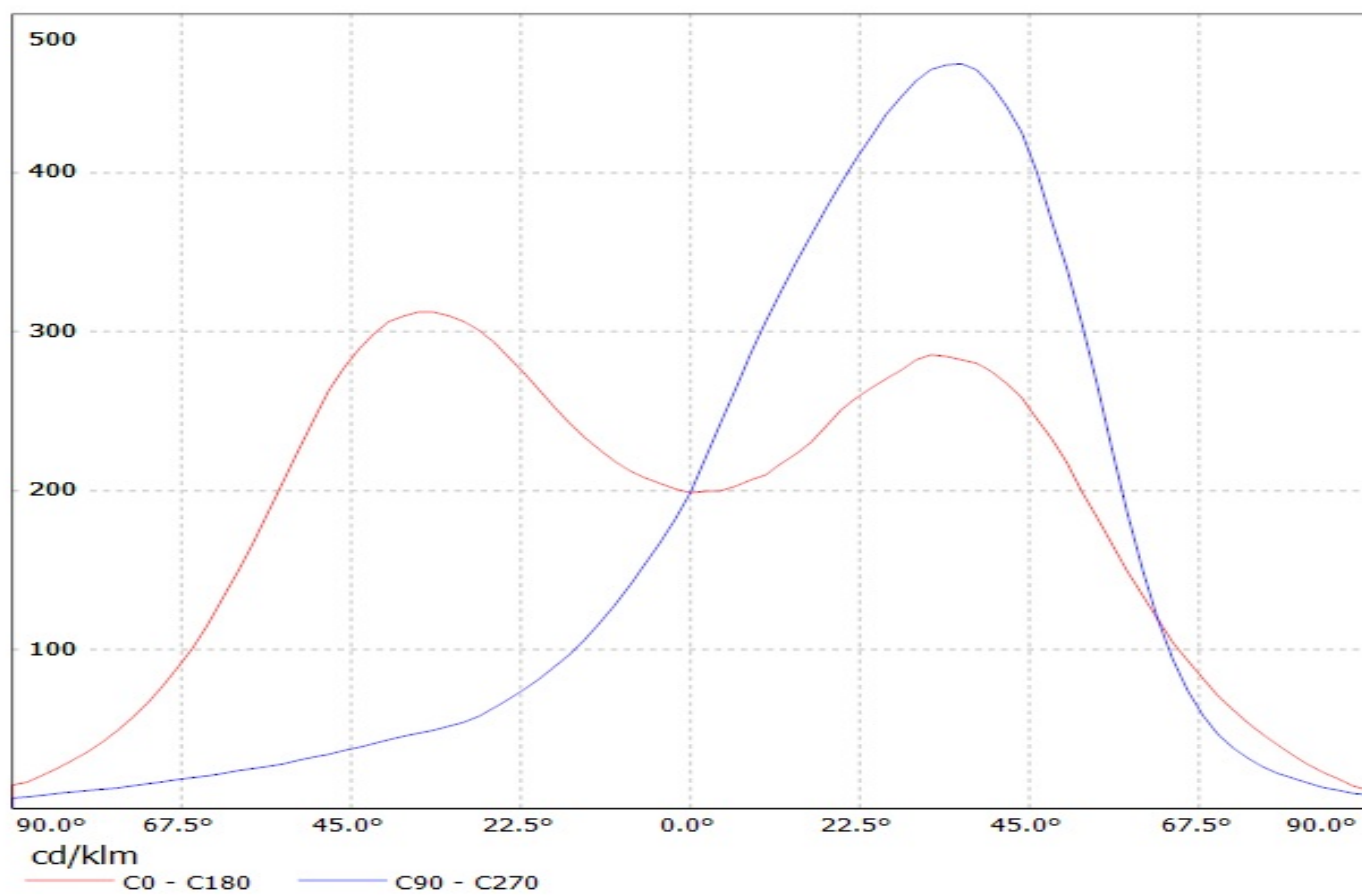

Ledil Oy C11415_Strada-T-DN-XP C11415_Strada-T-DN-XP / LDC (Polar)

Luminaire: Ledil Oy C11415_Strada-T-DN-XP C11415_Strada-T-DN-XP

Lamps: 1 x Cree XP-E (White)

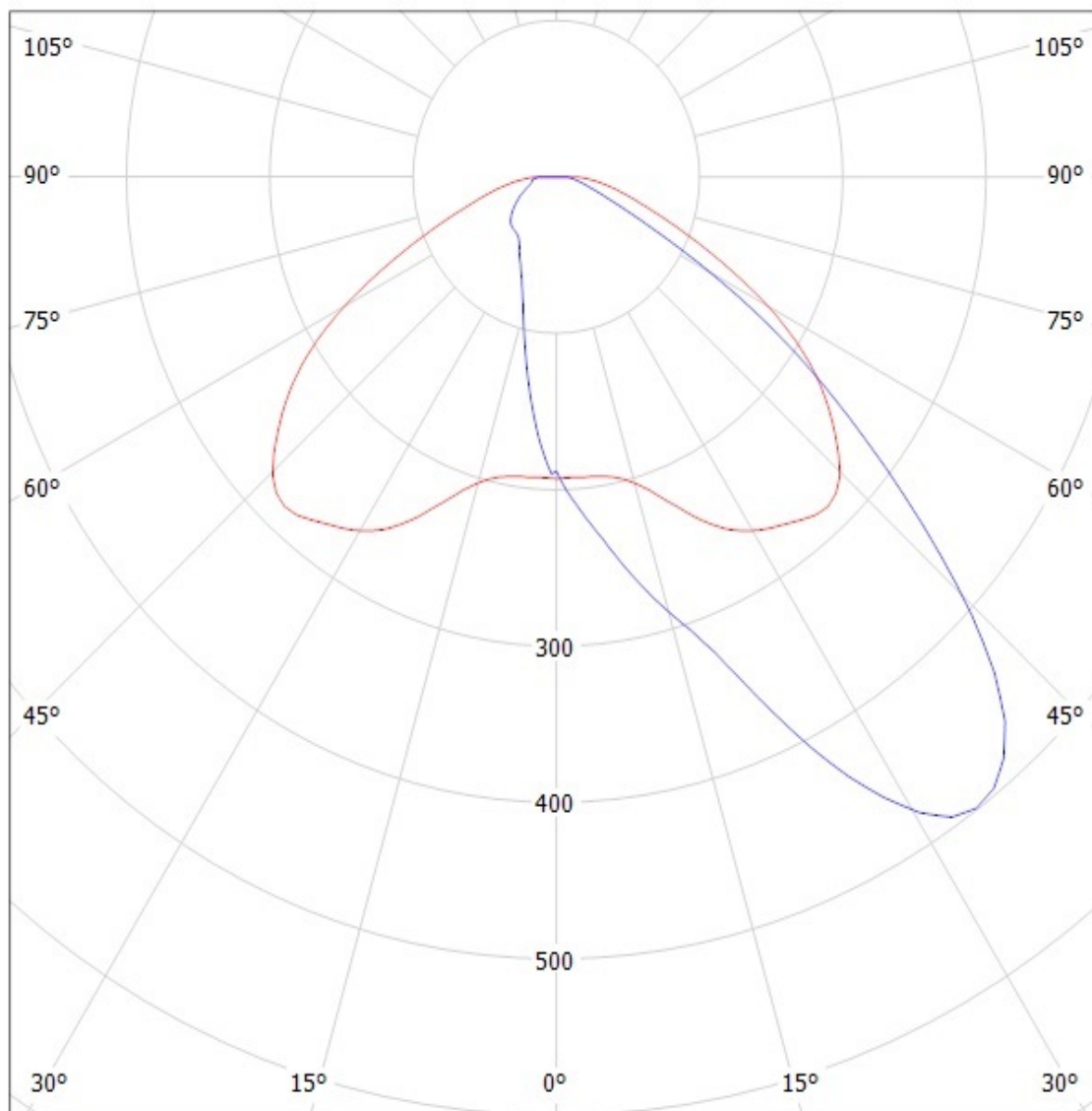

cd/klm

— C0 - C180

— C90 - C270

SIMULATED

Ledil Oy C11415_Strada-T-DN-XP-G C11415_Strada-T-DN-XP-G / LDC (Polar)

Luminaire: Ledil Oy C11415_Strada-T-DN-XP-G C11415_Strada-T-DN-XP-G

Lamps: 1 x Cree XP-G (White)

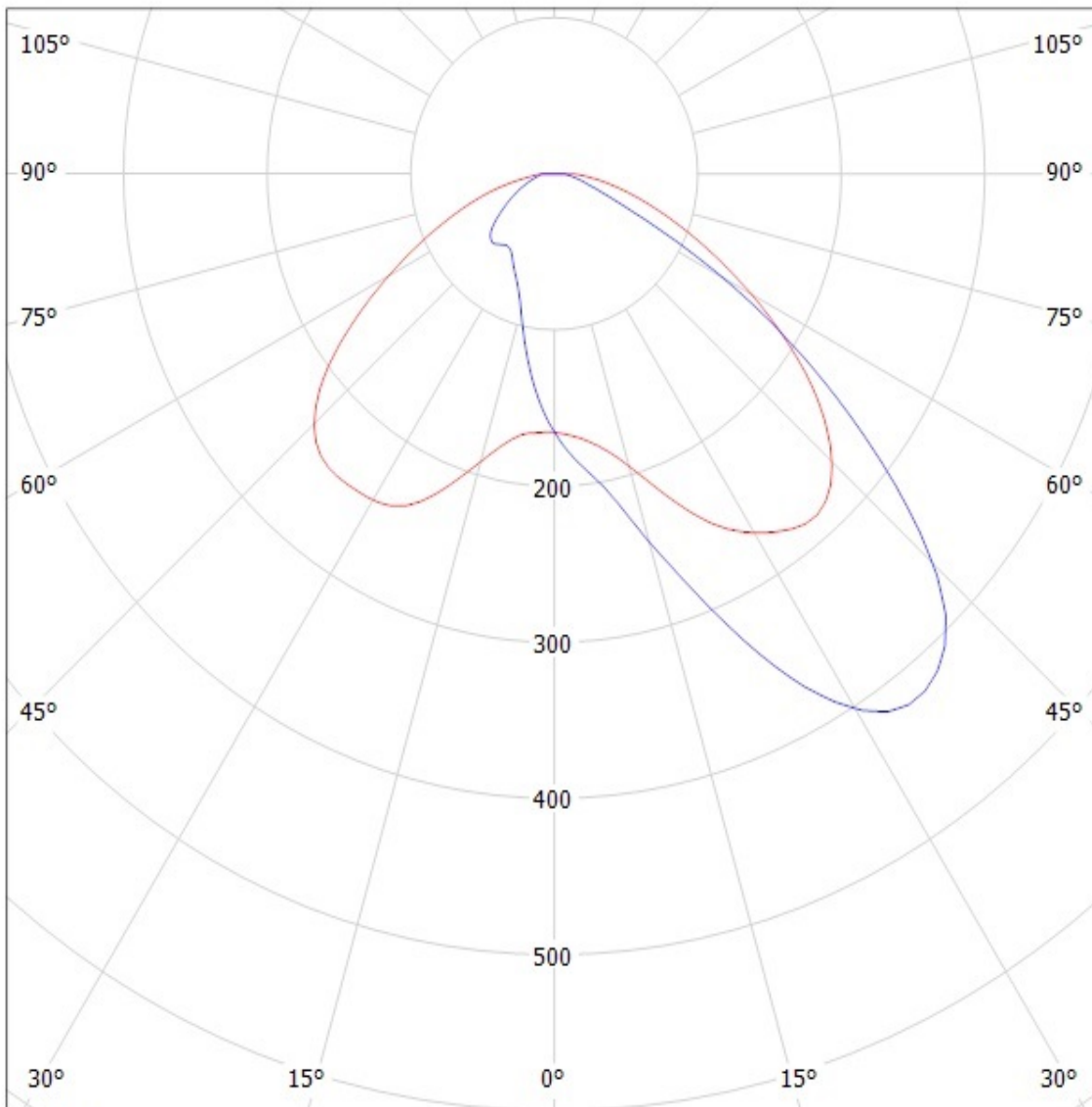

cd/klm

— C0 - C180

— C90 - C270

SIMULATED

Luminaire: LEDiL Oy CA11416_STRADA-T-DN_(LG3535) Eff. 89,1%
Lamps: 1 x LG Ceramic 3535 PKG (95lm@250mA)

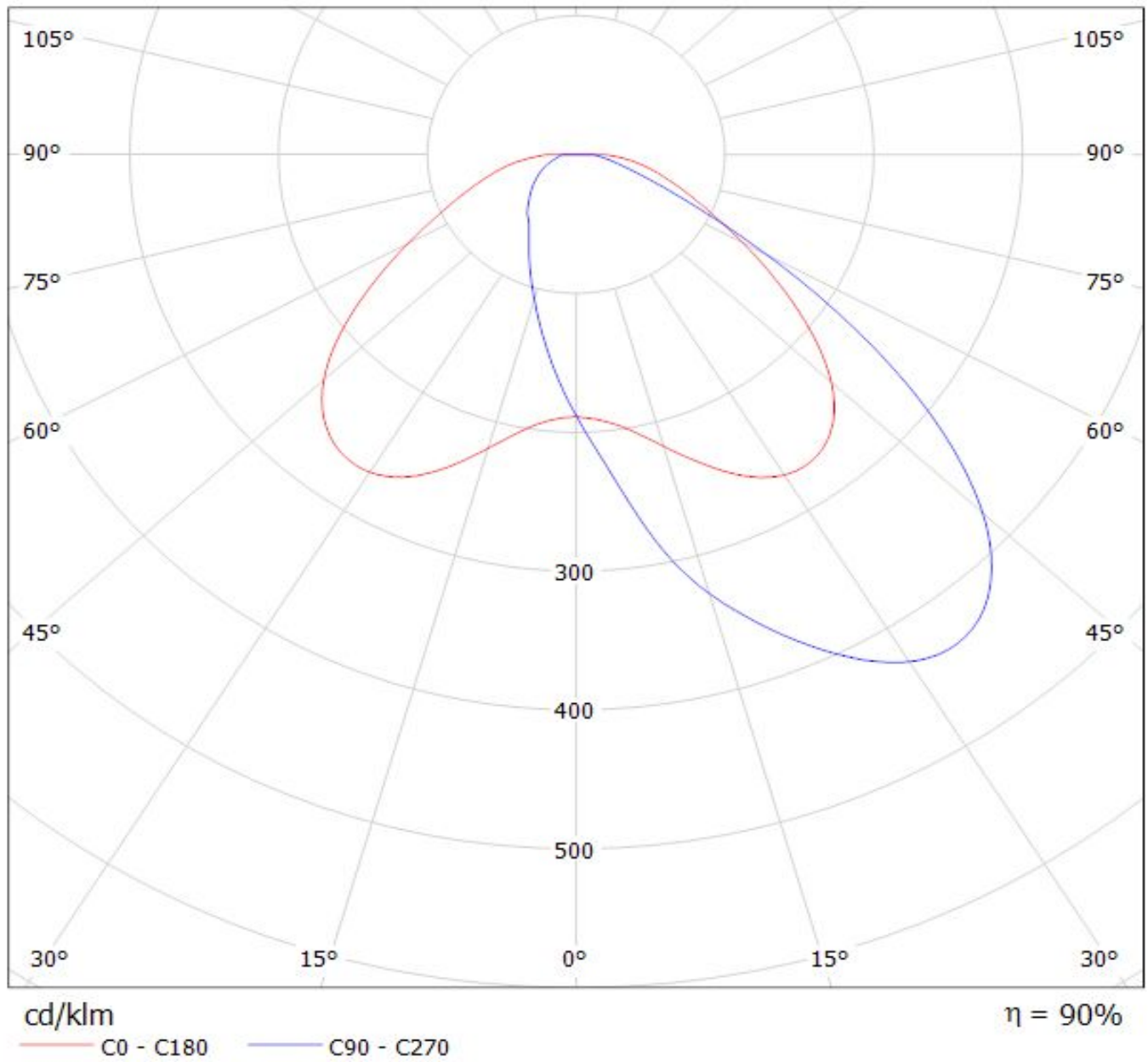

LEDiL Oy CA11416_STRADA-T-DN_(LG3535_2W) Eff.90.8% / LDC (Polar)

Luminaire: LEDiL Oy CA11416_STRADA-T-DN_(LG3535_2W) Eff.90.8%

Lamps: 1 x LG3535_2W (97.3629lm@250mA)

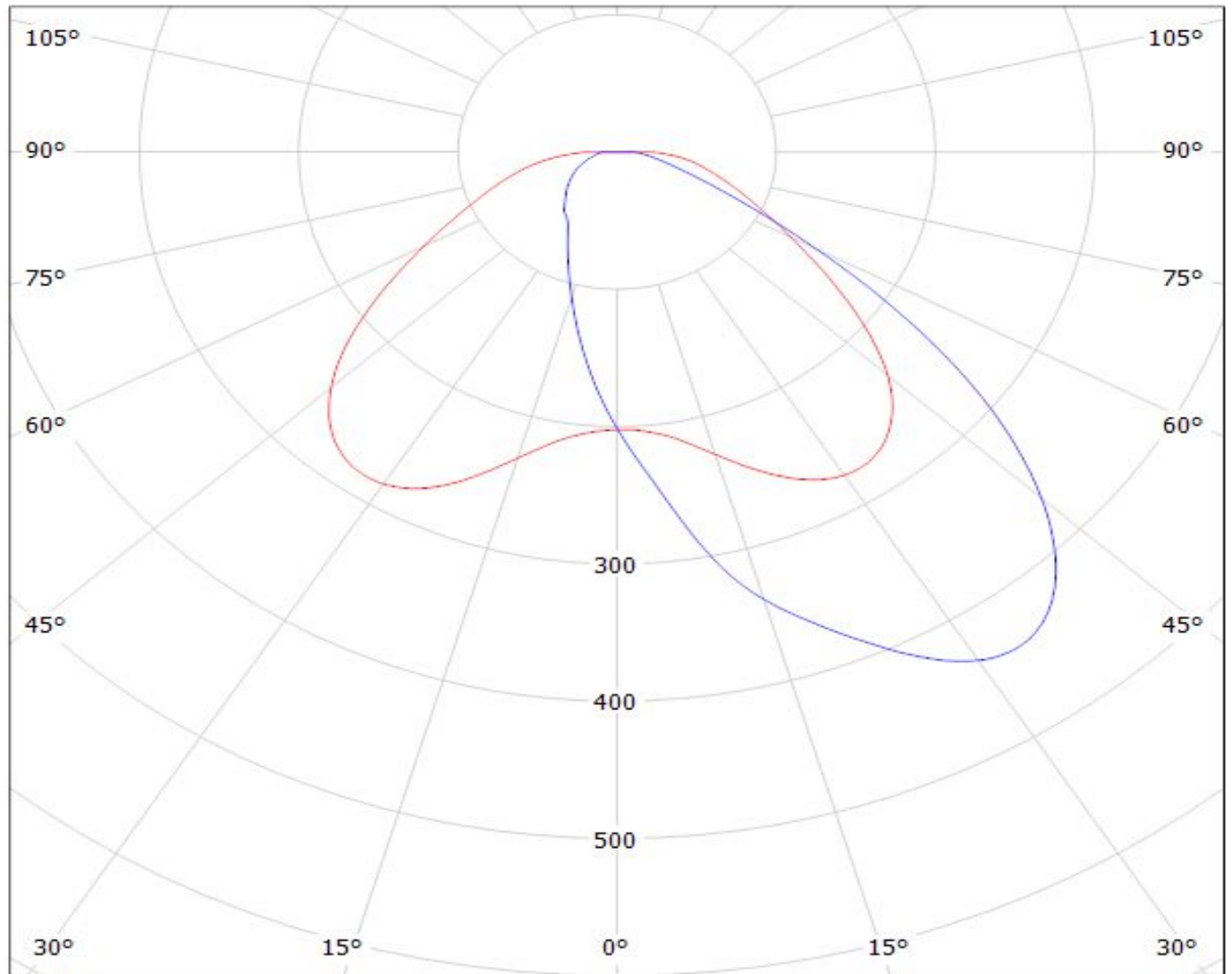

cd/klm

— C0 - C180

— C90 - C270

$\eta = 91\%$

Ledil Oy C11415_Strada-T-DN-RE C11415_Strada-T-DN-RE / LDC (Polar)

Luminaire: Ledil Oy C11415_Strada-T-DN-RE C11415_Strada-T-DN-RE

Lamps: 1 x Luxeon Rebel (warm white)

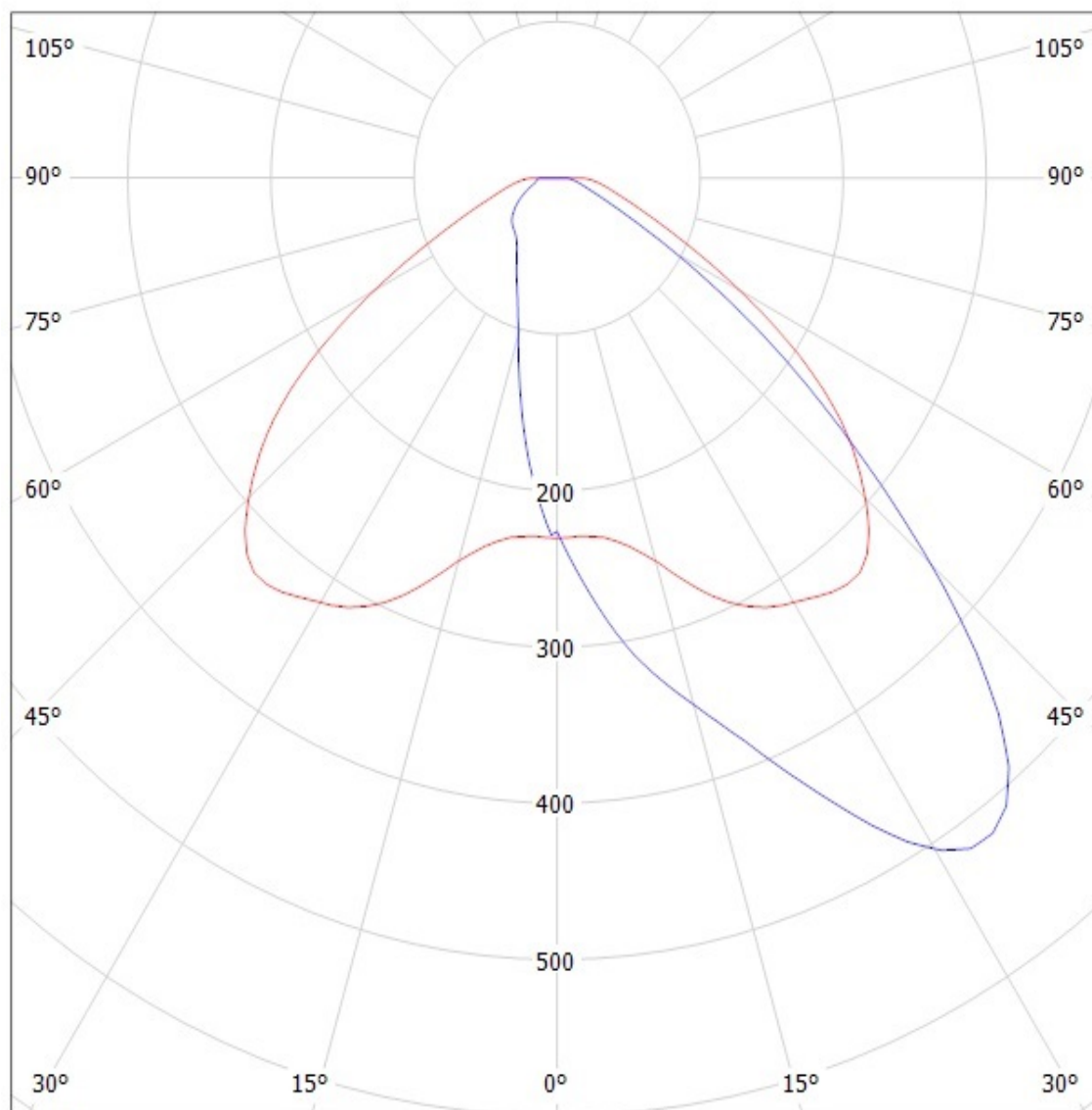

cd/klm

— C0 - C180

— C90 - C270

SIMULATED

Ledil Oy C11415_Strada-T-DN-RE-ES C11415_Strada-T-DN-RE-ES / LDC (Polar)

Luminaire: Ledil Oy C11415_Strada-T-DN-RE-ES C11415_Strada-T-DN-RE-ES
Lamps: 1 x Luxeon Rebel ES (white)

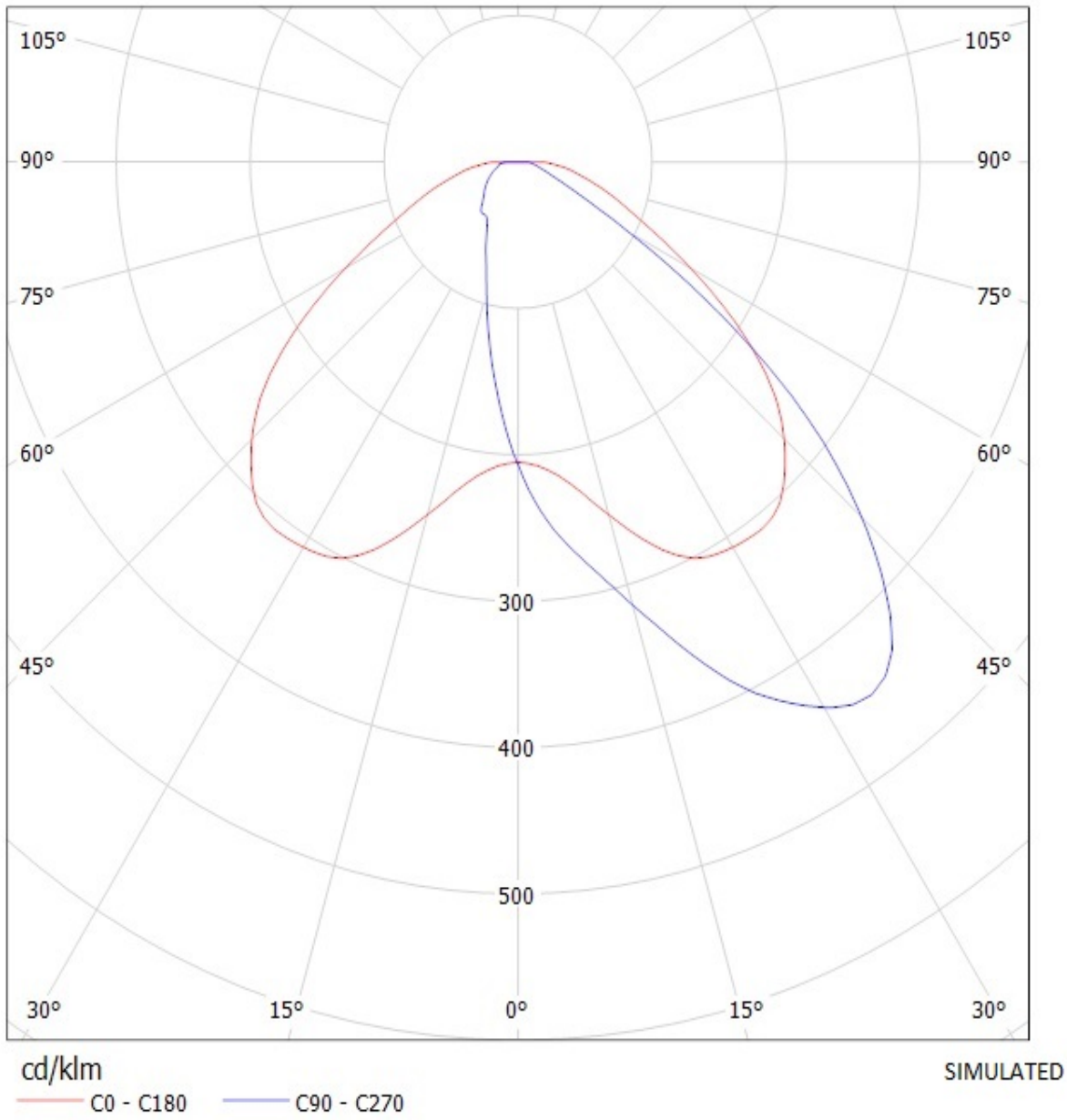

Luminaire: Ledil Oy CA11416_STRADA-T-DN_Luxeon-T_SIMULATED
Lamps: 1 x Luxeon T 100lm

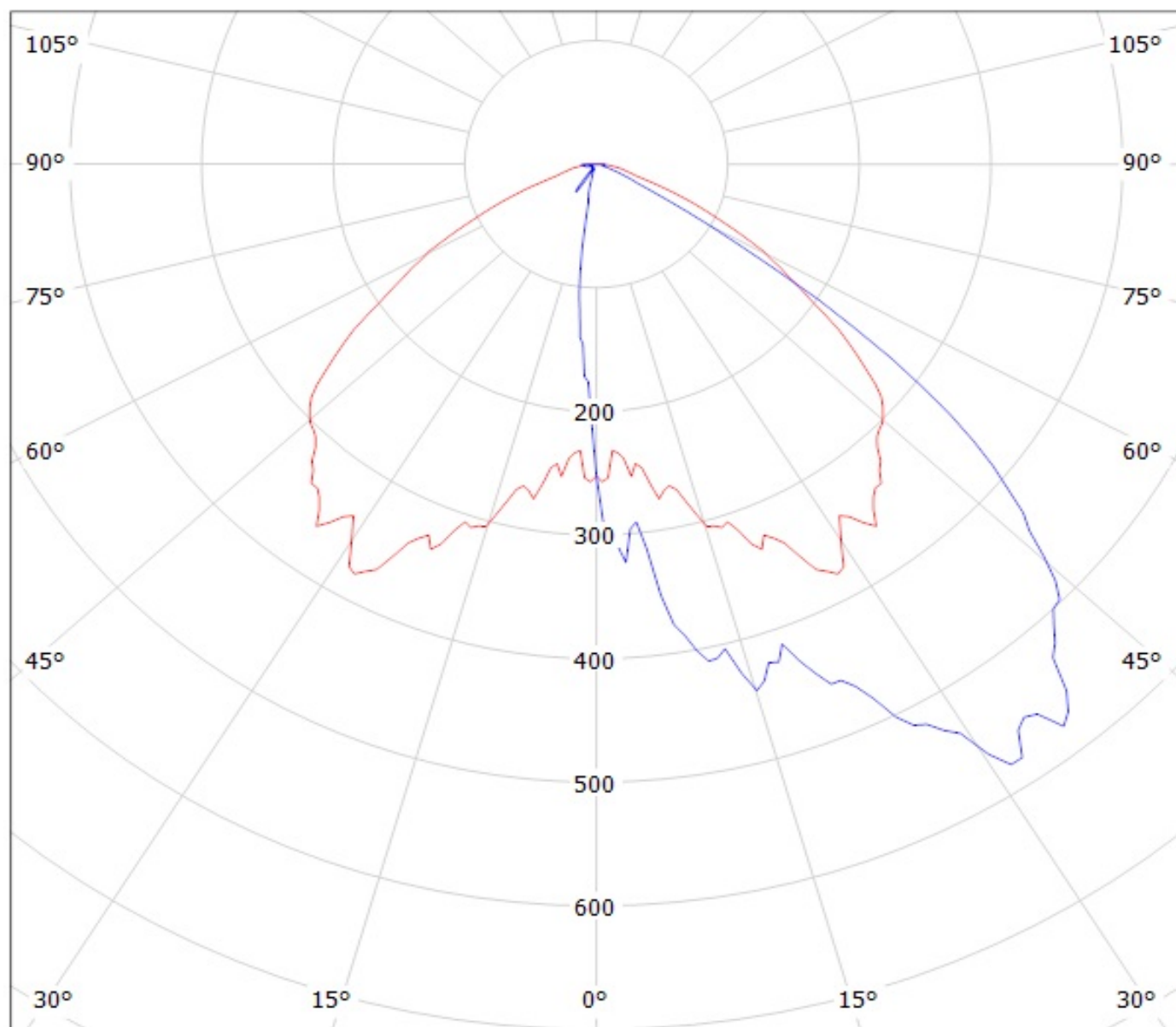

cd/klm

— C0 - C180

— C90 - C270

Luminaire: LEDiL Oy CA11416_STRADA-T-DN_(Luxeon_Z_ES) Eff.90.3%
Lamps: 1 x Luxeon_Z_ES_(LXZ2-3090)_50.8881lm@250mA_P=0.730433W_I=249.9mA

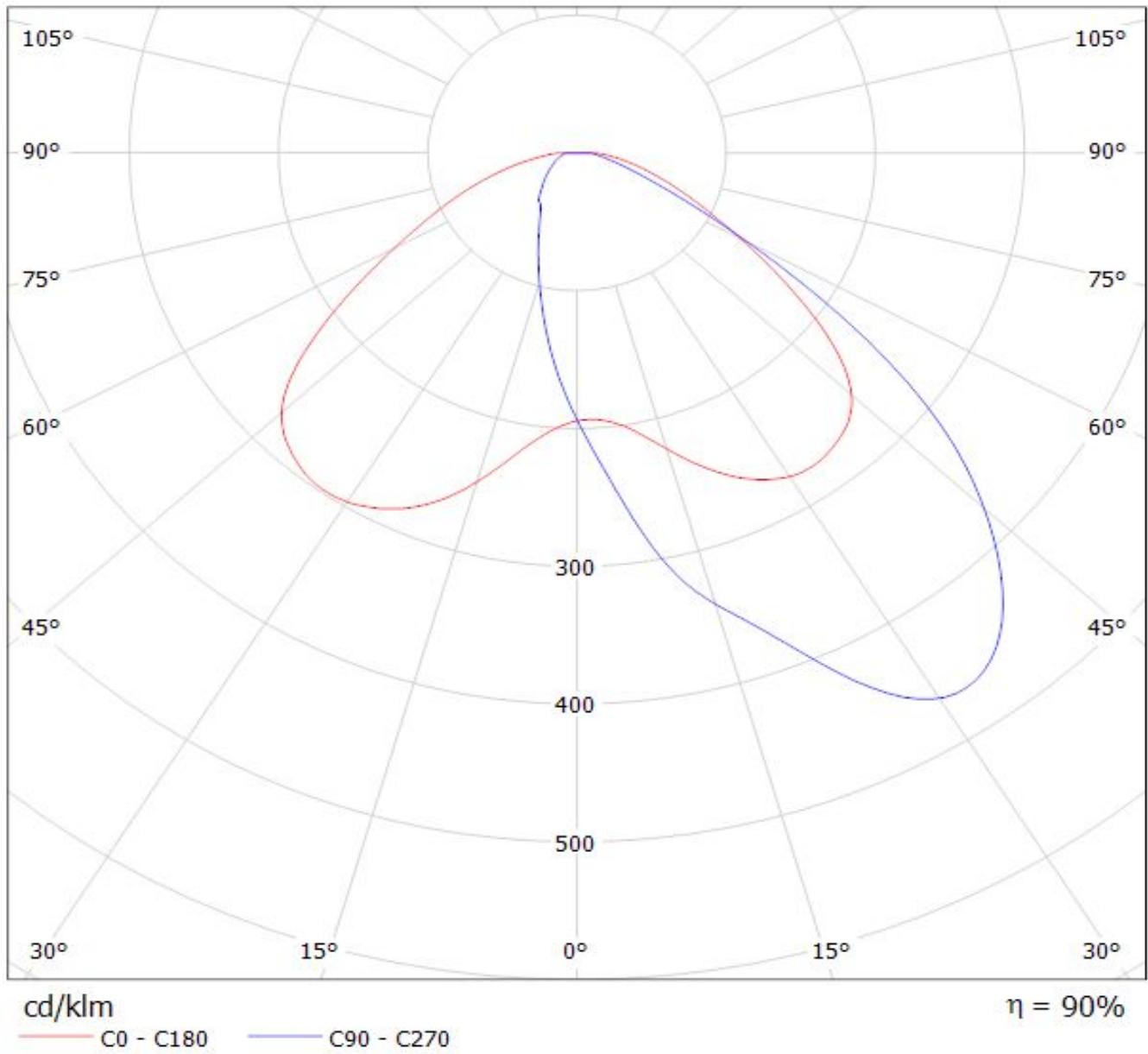

Luminaire: LEDiL Oy CA11416_STRADA-T-DN_(Luxeon_TX) Eff.91.2%
Lamps: 1 x Luxeon_TX_(L1T2-3585)_80.2531lm@250mA_CCT=3500K_P=0.730933W_I=249.9mA

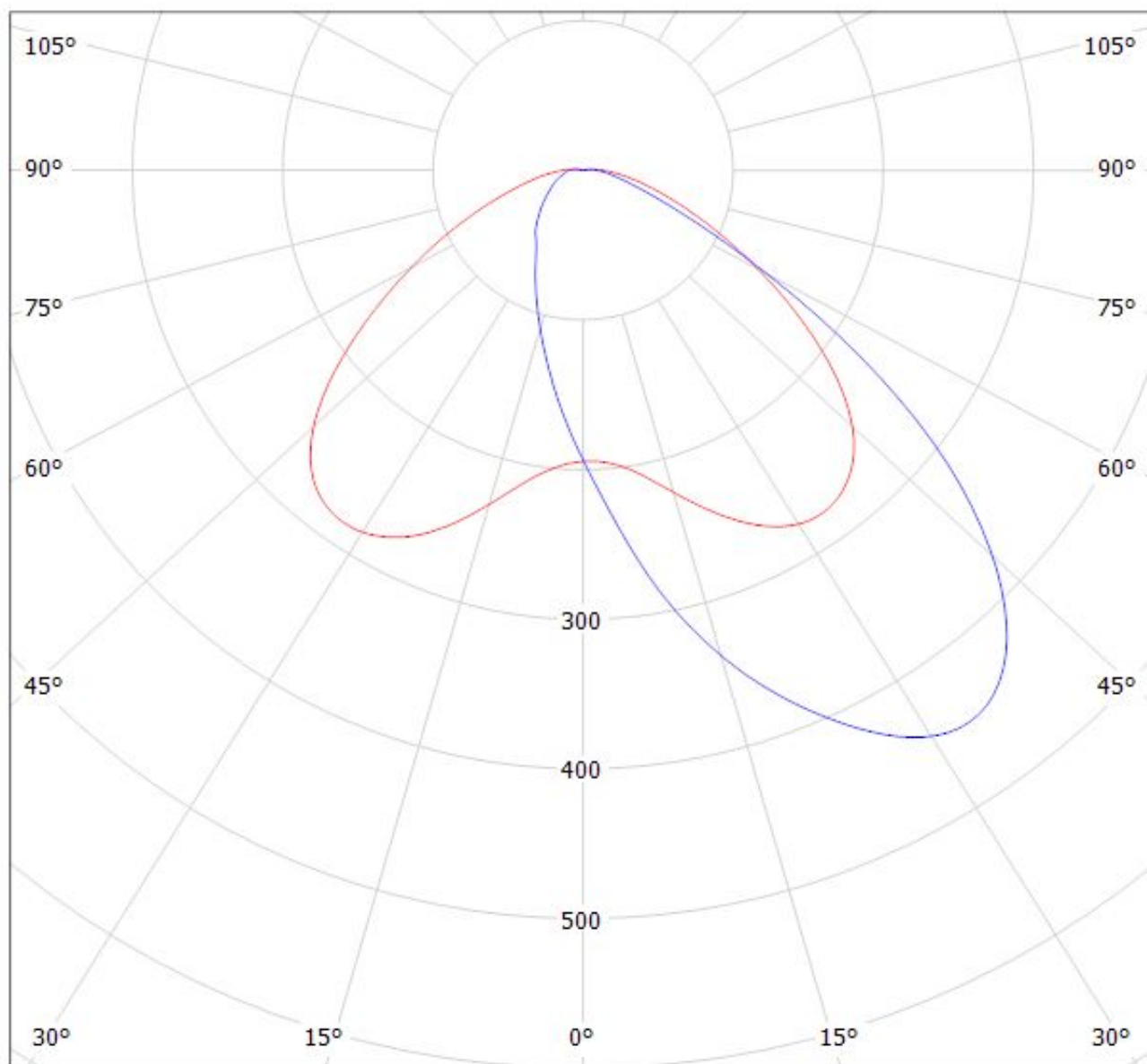

cd/klm

$\eta = 91\%$

— C0 - C180

— C90 - C270

Ledil Oy C11415_Strada-T-DN-OSL C11415_Strada-T-DN-OSL / LDC (Polar)

Luminaire: Ledil Oy C11415_Strada-T-DN-OSL C11415_Strada-T-DN-OSL

Lamps: 1 x Osram Oslon SSL (White)

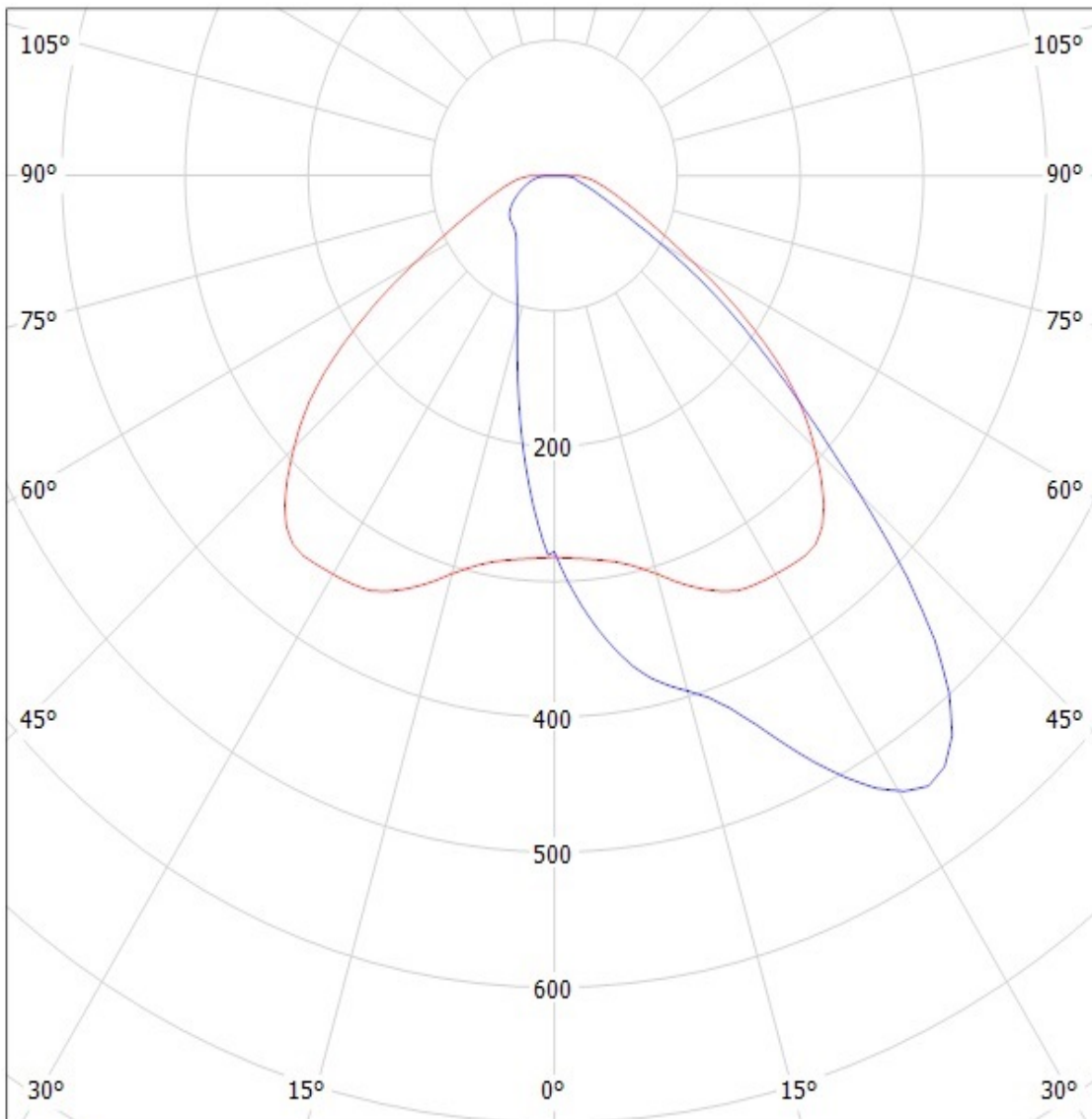

cd/klm

— C0 - C180 — C90 - C270

SIMULATED

Luminaire: LEDIL OY C11415_STRADA-T-DN / CA11416_STRADA-T-DN (SQ PC) Efficiency=93%
Lamps: 1 x Osram Oslon Square PC (93lm@250mA)

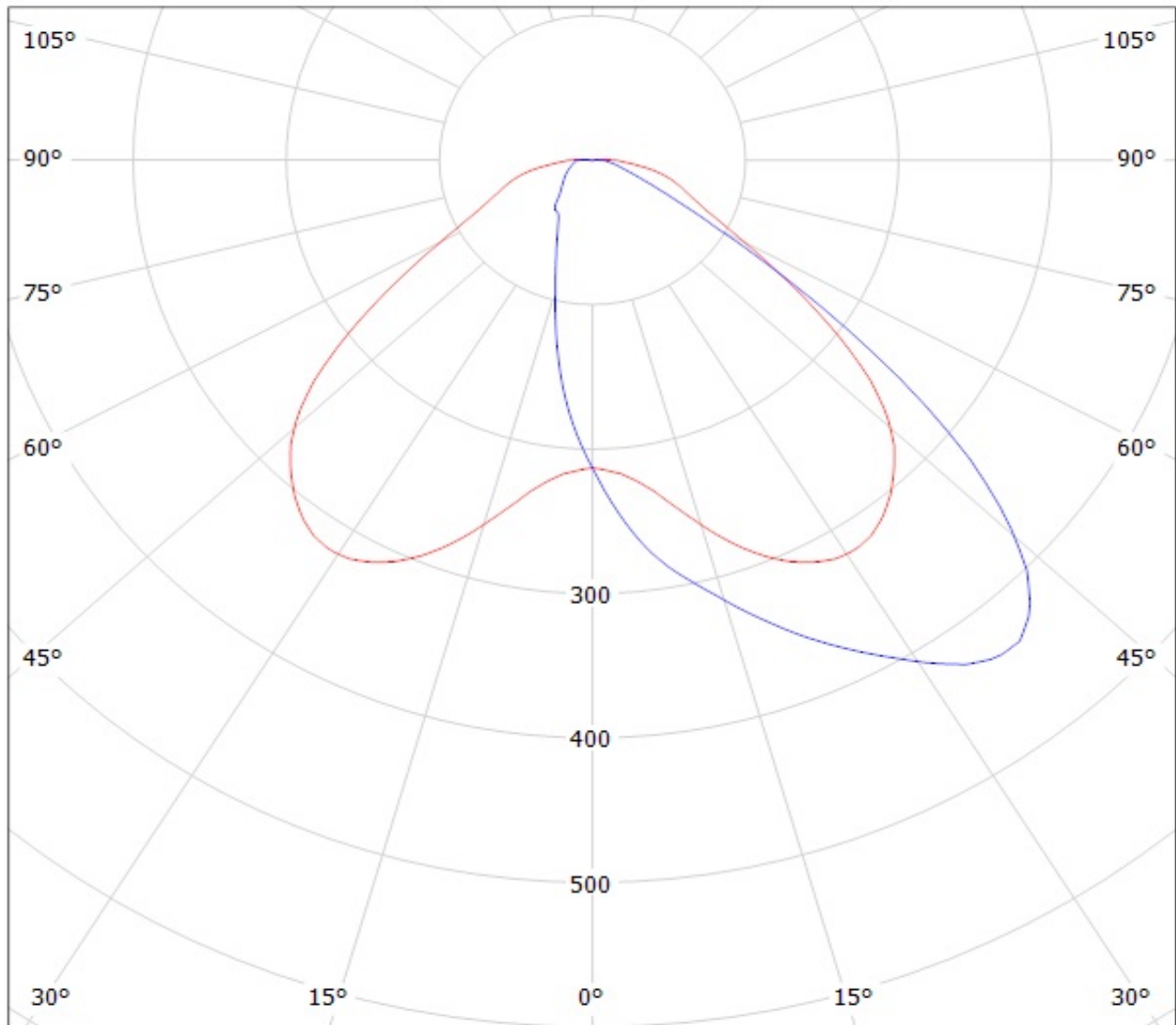

cd/klm

— C0 - C180 — C90 - C270

Luminaire: Ledil Oy CA11416_STRADA-T-DN_(Z5)_SIMULATED
Lamps: 1 x Seoul Z5 (SZW05A0B)

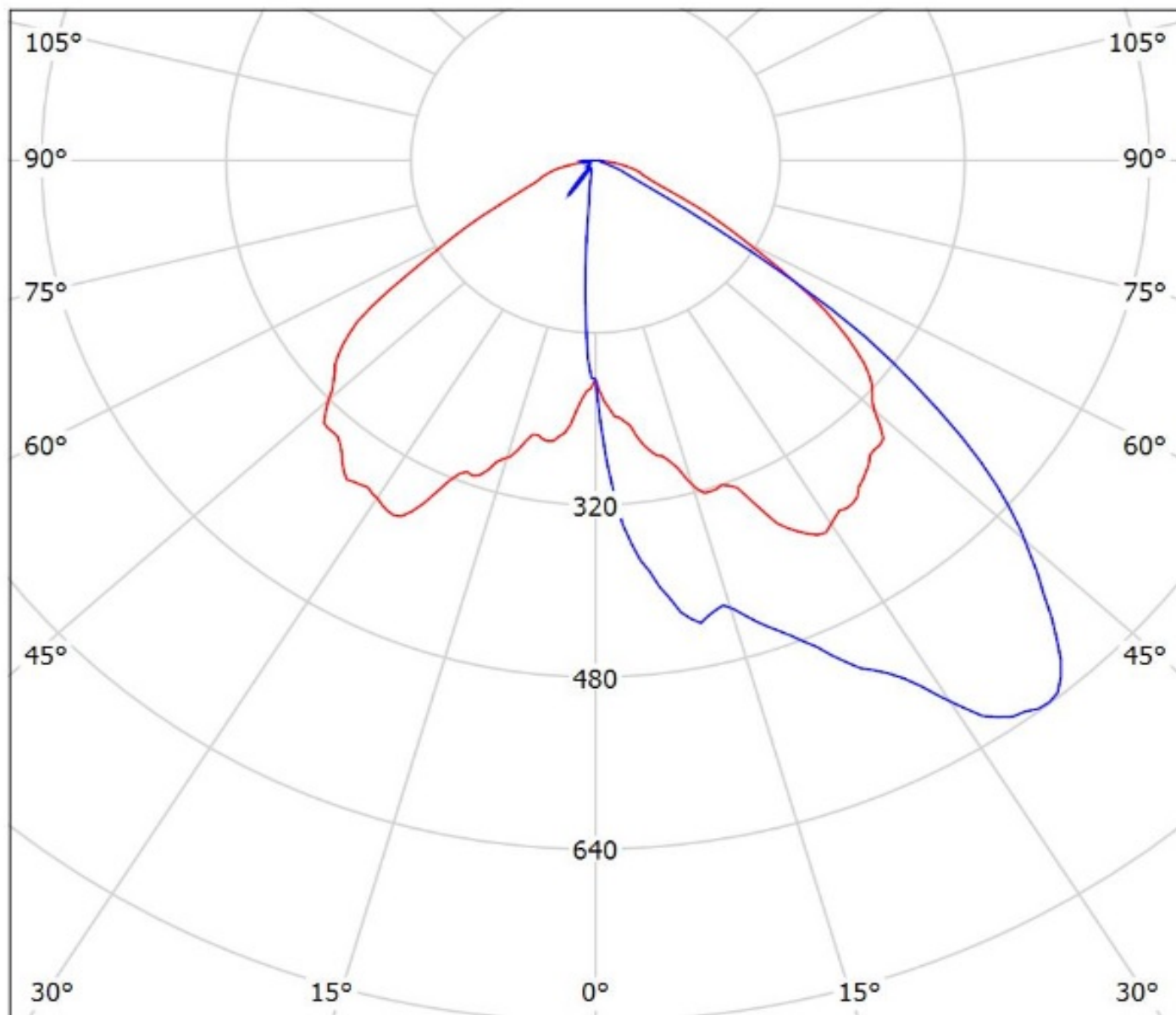

cd/klm

— C0 - C180 — C90 - C270

$\eta = 94\%$

Luminaire: LEDil Oy CA11416_STRADA-T-DN_(Z5M1) Efficiency=92%

Lamps: 1 x Seoul Z5M1 (SZ5M1-W0-C8/W1-A5-G) 108lm @ 250mA CCT=9100K P=0.8W I=250mA

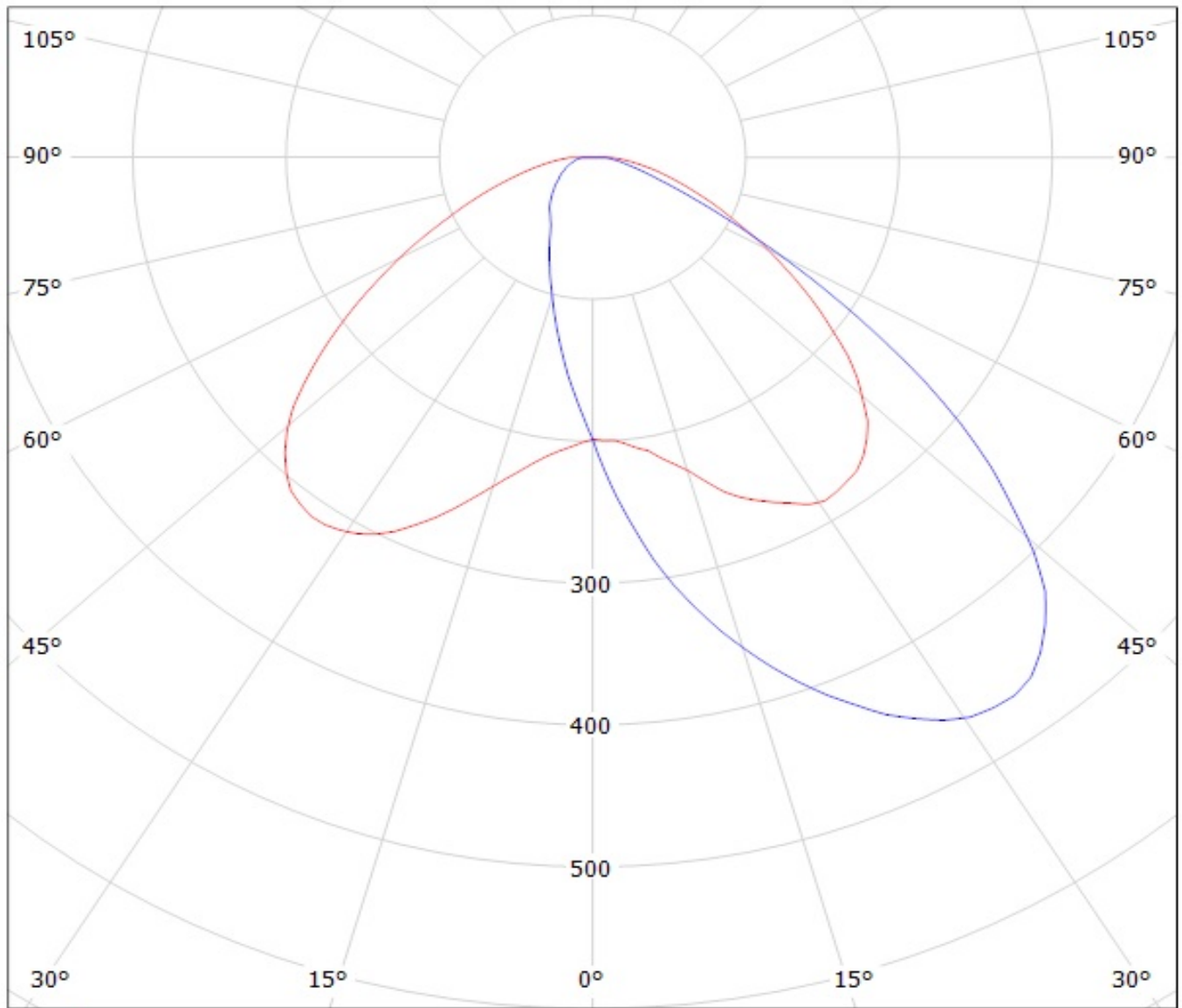

cd/klm

— C0 - C180

— C90 - C270

NOTE: The typical divergence will be changed by different color, chip size and chip position tolerance. The typical total divergence is the full angle measured where the luminous intensity is half of the peak value.