

# HDC1008 Low Power, High Accuracy Digital Humidity Sensor with Temperature Sensor

## 1 Features

- Relative Humidity (RH) Operating Range 0% to 100%
- 14 Bit Measurement Resolution
- Relative Humidity Accuracy  $\pm 4\%$
- Temperature Accuracy  $\pm 0.2\text{ }^{\circ}\text{C}$
- 200 nA Sleep Mode Current
- Average Supply Current:
  - 820 nA @ 1sps, 11 bit RH Measurement
  - 1.2  $\mu\text{A}$  @ 1sps, 11 bit RH and Temperature Measurement
- Supply Voltage 3 V to 5 V
- Tiny 2 mm x 1.6 mm Device Footprint
- I<sup>2</sup>C Interface

## 2 Applications

- HVAC
- Smart Thermostats and Room Monitors
- White Goods
- Printers
- Handheld Meters
- Medical Devices
- Cargo Shipping
- Automotive Windshield Defog
- Wearable Devices
- Mobile Devices

## 4 Typical Application

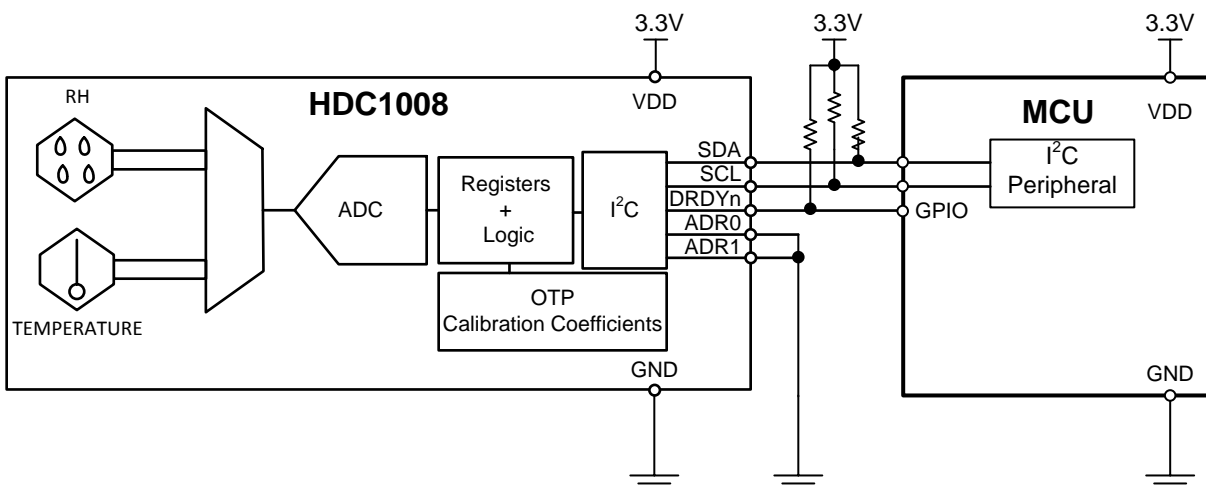

## 3 Description

The HDC1008 is a digital humidity sensor with integrated temperature sensor that provides excellent measurement accuracy at very low power. The device measures humidity based on a novel capacitive sensor. The humidity and temperature sensors are factory calibrated. The innovative WLCSP (Wafer Level Chip Scale Package) simplifies board design with the use of an ultra-compact package. The sensing element of the HDC1008 is placed on the bottom part of the device, which makes the HDC1008 more robust against dirt, dust, and other environmental contaminants. The HDC1008 is functional within the full  $-40^{\circ}\text{C}$  to  $+125^{\circ}\text{C}$  temperature range.

### Device Information <sup>(1)</sup>

PART NUMBER	PACKAGE	BODY SIZE (NOM)
HDC1008	DSBGA (8-bump)	2.04 mm x 1.59 mm

(1) For all available packages, see the orderable addendum at the end of the datasheet.



## Table of Contents

<b>1 Features</b> .....	<b>1</b>	8.4 Device Functional Modes.....	<b>9</b>
<b>2 Applications</b> .....	<b>1</b>	8.5 Programming.....	<b>10</b>
<b>3 Description</b> .....	<b>1</b>	8.6 Register Map .....	<b>14</b>
<b>4 Typical Application</b> .....	<b>1</b>	<b>9 Application and Implementation</b> .....	<b>16</b>
<b>5 Revision History</b> .....	<b>2</b>	9.1 Application Information.....	<b>16</b>
<b>6 Pin Configuration and Functions</b> .....	<b>3</b>	9.2 Typical Application .....	<b>16</b>
<b>7 Specifications</b> .....	<b>4</b>	9.3 Do's and Don'ts .....	<b>18</b>
7.1 Absolute Maximum Ratings .....	<b>4</b>	<b>10 Power Supply Recommendations</b> .....	<b>18</b>
7.2 ESD Ratings.....	<b>4</b>	<b>11 Layout</b> .....	<b>19</b>
7.3 Recommended Operating Conditions.....	<b>4</b>	11.1 Layout Guidelines .....	<b>19</b>
7.4 Thermal Information .....	<b>4</b>	11.2 Layout Example .....	<b>21</b>
7.5 Electrical Characteristics.....	<b>5</b>	<b>12 Device and Documentation Support</b> .....	<b>22</b>
7.6 I <sup>2</sup> C Interface Electrical Characteristics.....	<b>6</b>	12.1 Documentation Support .....	<b>22</b>
7.7 I <sup>2</sup> C Interface Timing Requirements .....	<b>6</b>	12.2 Community Resources.....	<b>22</b>
7.8 Typical Characteristics.....	<b>7</b>	12.3 Trademarks .....	<b>22</b>
<b>8 Detailed Description</b> .....	<b>9</b>	12.4 Electrostatic Discharge Caution.....	<b>22</b>
8.1 Overview .....	<b>9</b>	12.5 Glossary .....	<b>22</b>
8.2 Functional Block Diagram .....	<b>9</b>	<b>13 Mechanical, Packaging, and Orderable Information</b> .....	<b>22</b>
8.3 Feature Description.....	<b>9</b>		

## 5 Revision History

<b>Changes from Revision A (November 2014) to Revision B</b>	<b>Page</b>
• Deleted references to functional and operating temperature ranges. ....	<b>1</b>
• Changed wording to clarify .....	<b>3</b>
• Moved Storage Temperature to Abs Max Rating Table .....	<b>4</b>
• Changed Handling Ratings table to ESD Ratings table. ....	<b>4</b>
• Added separate conditions for RH .....	<b>4</b>
• Added RH condition .....	<b>5</b>
• Added figure reference. ....	<b>5</b>
• Added condition .....	<b>5</b>
• Changed wording to clarify hysteresis definition .....	<b>5</b>
• Changed recommended operating range .....	<b>5</b>
• Changed register reference for supply voltage monitoring. The original reference was incorrect .....	<b>9</b>
• Added recommendation for recovery from soldering. ....	<b>18</b>

<b>Changes from Original (October 2014) to Revision A</b>	<b>Page</b>
• Changed Datasheet's title .....	<b>1</b>
• Changed description.....	<b>1</b>
• Changed overview .....	<b>9</b>
• Changed application information .....	<b>16</b>
• Changed recovery from soldering .....	<b>18</b>

## 6 Pin Configuration and Functions

**WLCSP (DSBGA)  
8 Pin YPA  
Top View**

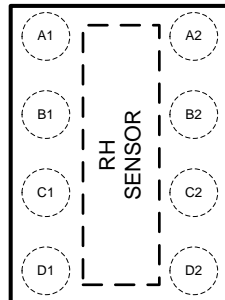

**Pin Functions**

PIN		I/O TYPE <sup>(1)</sup>	DESCRIPTION
NAME	NO.		
SCL	A1	I	Serial clock line for I <sup>2</sup> C, open-drain; requires a pull-up resistor to VDD
VDD	B1	P	Supply Voltage
ADR0	C1	I	Address select pin – hardwired to GND or VDD
ADR1	D1	I	Address select pin – hardwired to GND or VDD
SDA	A2	I/O	Serial data line for I <sup>2</sup> C, open-drain; requires a pull-up resistor to VDD
GND	B2	G	Ground
DNC	C2	-	Do Not Connect, or may be connected to GND
DRDYn	D2	O	Data ready, active low, open-drain, requires a pull-up resistor to VDD. If not used tie to GND.

(1) P=Power, G=Ground, I=Input, O=Output

## 7 Specifications

### 7.1 Absolute Maximum Ratings<sup>(1)</sup>

		MIN	MAX	UNIT
Input Voltage	VDD	-0.3	6	V
	SCL	-0.3	6	
	SDA	-0.3	6	
	DRDYn	-0.3	6	
	ADR0	-0.3	VDD+0.3	
	ADR1	-0.3	VDD+0.3	
Storage Temperature	T <sub>STG</sub> <sup>(2)</sup>	-65	150	°C

- (1) Stresses beyond those listed under *Absolute Maximum Ratings* may cause permanent damage to the device. These are stress ratings only, which do not imply functional operation of the device at these or any other conditions beyond those indicated under *Recommended Operating Conditions*. Exposure to absolute-maximum-rated conditions for extended periods may affect device reliability.
- (2) For long term storage, it is recommended to stay within 10%RH-80%RH and +5°C to 60°C. Storage beyond this range may result in a temporary RH offset shift.

### 7.2 ESD Ratings

			VALUE	UNIT
V <sub>(ESD)</sub>	Electrostatic discharge	Human body model (HBM), per ANSI/ESDA/JEDEC JS-001, all pins <sup>(1)</sup>	±1000	V
		Charged device model (CDM), per JEDEC specification –500 500 JESD22-C101, all pins <sup>(2)</sup>	±250	

- (1) JEDEC document JEP155 states that 500-V HBM allows safe manufacturing with a standard ESD control process.
- (2) JEDEC document JEP157 states that 250-V CDM allows safe manufacturing with a standard ESD control process.

### 7.3 Recommended Operating Conditions

over operating range (unless otherwise noted)

		MIN	NOM	MAX	UNIT
V <sub>DD</sub>	Supply Voltage	2.7	3	5.5	V
T <sub>A</sub> , Temperature Sensor	Ambient Operating Temperature	-40		125	°C
T <sub>A</sub> , Humidity Sensor	Ambient Operating Temperature	-20		60	°C

### 7.4 Thermal Information

THERMAL METRIC <sup>(1)</sup>		HDC1008	UNIT
		DSBGA (YPA)	
		8 PINS	
R <sub>θJA</sub>	Junction-to-Ambient Thermal Resistance	98.0	°C/W

- (1) For more information about traditional and new thermal metrics, see the: *IC Package Thermal Metrics* application report, [SPRA953](#).

## 7.5 Electrical Characteristics

The electrical ratings specified in this section apply to all specifications in this document, unless otherwise noted.  $T_A = 30^\circ\text{C}$ ,  $V_{DD} = 3\text{V}$ , and  $\text{RH} = 40\%$ .

PARAMETER	TEST CONDITION	MIN	TYP	MAX	UNIT
<b>POWER CONSUMPTION</b>					
$I_{DD}$ Supply Current	RH measurement, bit 12 of 0x02 register = 0 <sup>(1)</sup>		180	220	$\mu\text{A}$
	Temperature measurement, bit 12 of 0x02 register = 0 <sup>(1)</sup>		155	185	$\mu\text{A}$
	Sleep Mode		110	200	nA
	Average @ 1 measurement/second, RH (11 bit), bit 12 of 0x02 register = 0 <sup>(1)(2)</sup>		730		nA
	Average @ 1 measurement/second, Temp (11 bit), bit 12 of 0x02 register = 0 <sup>(1)(2)</sup>		580		nA
	Average @ 1 measurement/second, RH (11bit) +temperature (11 bit), bit 12 of 0x02 register = 1 <sup>(1)(2)</sup>		1.2		$\mu\text{A}$
	Startup (average on Start-up time)		300		$\mu\text{A}$
$I_{HEAT}$ Heater Current <sup>(3)</sup>	Peak current		7.6		mA
	Average @ 1 measurement/second, RH (11bit) +temperature (11 bit), bit 12 of 0x02 register = 1 <sup>(1)(2)</sup>		57		$\mu\text{A}$
<b>RELATIVE HUMIDITY SENSOR</b>					
$\text{RH}_{ACC}$ Accuracy	Refer to <a href="#">Figure 2</a> in Typical Characteristics section.		$\pm 4$		%RH
$\text{RH}_{REP}$ Repeatability <sup>(3)</sup>	0%RH		$\pm 0.1$		%RH
$\text{RH}_{HYS}$ Hysteresis <sup>(4)</sup>	$20\% \leq \text{RH} \leq 60\%$		$\pm 1$		%RH
$\text{RH}_{RT}$ Response Time <sup>(5)</sup>	$t_{63\%}$ <sup>(6)</sup>		15		s
$\text{RH}_{CT}$ Conversion Time <sup>(3)</sup>	8 bit resolution		2.50		ms
	11 bit resolution		3.85		ms
	14 bit resolution		6.50		ms
$\text{RH}_{HOR}$ Operating Range <sup>(7)</sup>	Non-condensing	0		100	%RH
$\text{RH}_{LTD}$ Long Term Drift			$\pm 0.5$		%RH/yr
<b>TEMPERATURE SENSOR</b>					
$\text{TEMP}_{ACC}$ Accuracy <sup>(3)</sup>	$5^\circ\text{C} < T_A < 60^\circ\text{C}$		$\pm 0.2$	$\pm 0.4$	$^\circ\text{C}$
$\text{TEMP}_{REP}$ Repeatability <sup>(3)</sup>			$\pm 0.1$		$^\circ\text{C}$
$\text{TEMP}_{CT}$ Conversion Time <sup>(3)</sup>	11 bit accuracy		3.65		ms
	14 bit accuracy		6.35		ms
$\text{TEMP}_{OR}$ Operating Range		-40		125	$^\circ\text{C}$

- (1) I<sup>2</sup>C read/write communication and pull-up resistors current through SCL, SDA and DRDYn not included.
- (2) Average current consumption while conversion is in progress.
- (3) This parameter is specified by design and/or characterization and it is not tested in production.
- (4) The hysteresis value is the difference between an RH measurement in a rising and falling RH environment, at a specific RH point.
- (5) Actual response times will vary dependent on system thermal mass and air-flow.
- (6) Time for the RH output to change by 63% of the total RH change after a step change in environmental humidity.
- (7) Recommended humidity operating range is 20% to 60% RH. Prolonged operation outside this range may result in a measurement offset. The measurement offset will decrease after operating the sensor in this recommended operating range.

## 7.6 I<sup>2</sup>C Interface Electrical Characteristics

At T<sub>A</sub>=30°C, V<sub>DD</sub>=3V (unless otherwise noted)

PARAMETER	TEST CONDITION	MIN	TYP	MAX	UNIT
<b>I<sup>2</sup>C INTERFACE VOLTAGE LEVEL</b>					
V <sub>IH</sub>	Input High Voltage	0.7xV <sub>DD</sub>			V
V <sub>IL</sub>	Input Low Voltage			0.3xV <sub>DD</sub>	V
V <sub>OL</sub>	Output Low Voltage	Sink current 3mA		0.4	V
HYS	Hysteresis <sup>(1)</sup>	0.1xV <sub>DD</sub>			V
C <sub>IN</sub>	Input Capacitance on all digital pins		0.5		pF

(1) This parameter is specified by design and/or characterization and it is not tested in production.

## 7.7 I<sup>2</sup>C Interface Timing Requirements

PARAMETER	TEST CONDITION	MIN	TYP	MAX	UNIT
<b>I<sup>2</sup>C INTERFACE VOLTAGE LEVEL</b>					
f <sub>SCL</sub>	Clock Frequency	10		400	kHz
t <sub>LOW</sub>	Clock Low Time	1.3			µs
t <sub>HIGH</sub>	Clock High Time	0.6			µs
t <sub>SP</sub>	Pulse width of spikes that must be suppressed by the input filter <sup>(1)</sup>			50	ns
t <sub>START</sub>	Device Start-up time	From V <sub>DD</sub> ≥ 2.7 V to ready for a conversion <sup>(1)(2)</sup>	10	15	ms

(1) This parameter is specified by design and/or characterization and it is not tested in production.

(2) Within this interval it is not possible to communicate to the device.

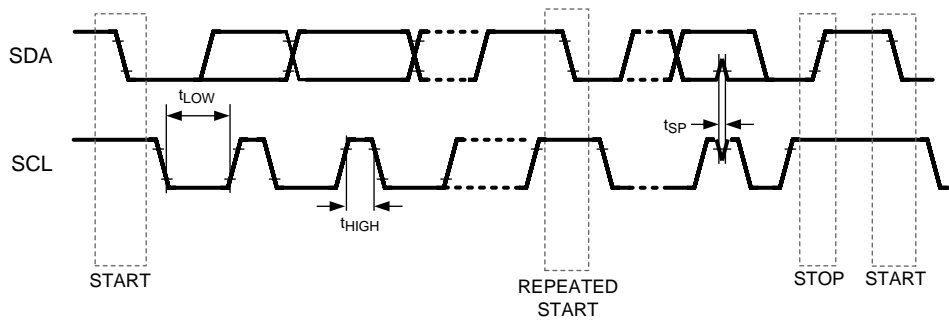

Figure 1. I<sup>2</sup>C Timing

### 7.8 Typical Characteristics

Unless otherwise noted,  $T_A = 30^\circ\text{C}$ ,  $V_{DD} = 3\text{V}$ .

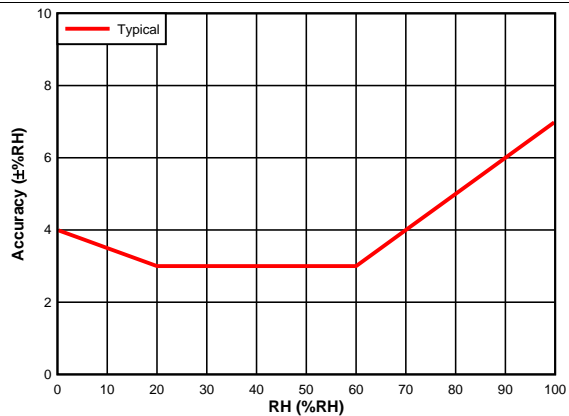

Figure 2. RH Accuracy vs. RH

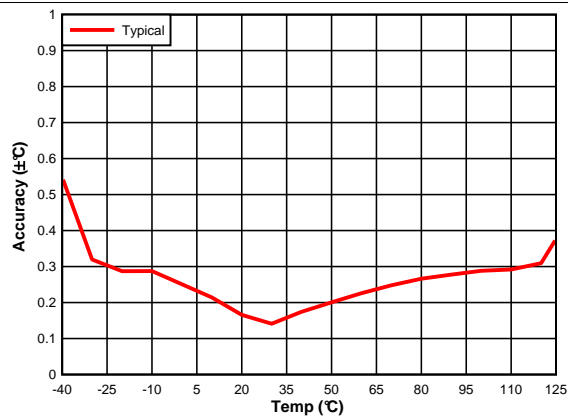

Figure 3. Temperature Accuracy vs. Temperature

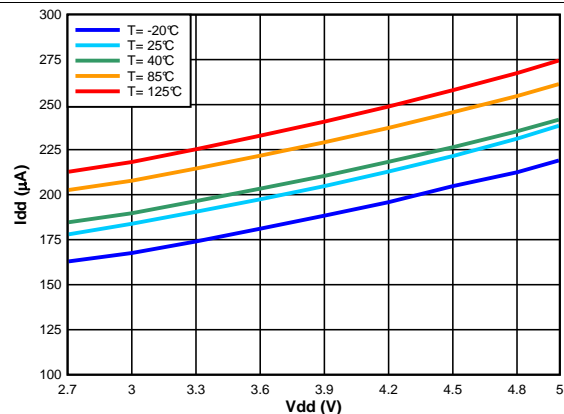

Figure 4. Supply Current vs. Supply Voltage, RH Measurement

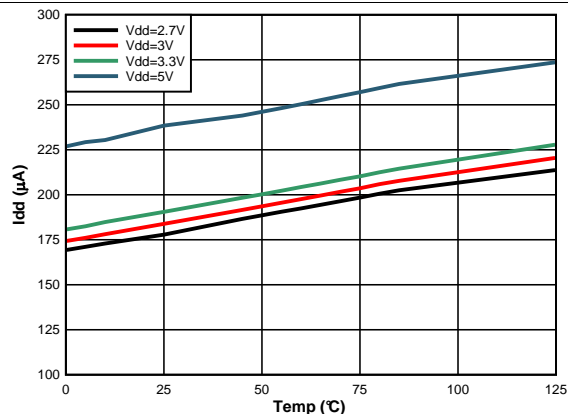

Figure 5. Supply Current vs. Temperature, RH Measurement

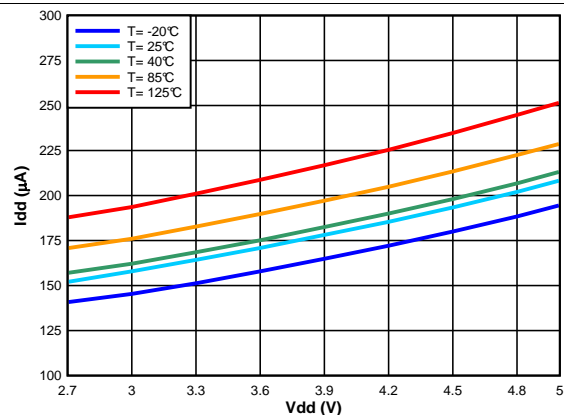

Figure 6. Supply Current vs. Supply Voltage, Temp Measurement

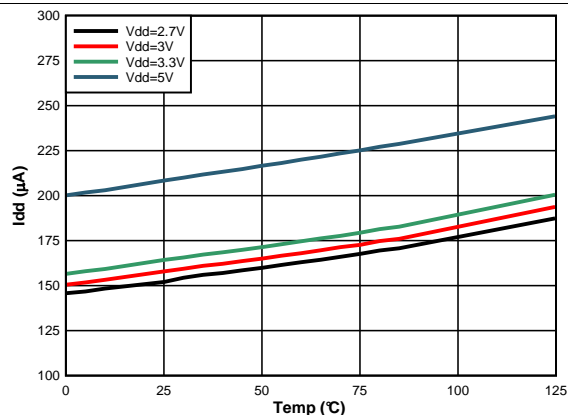
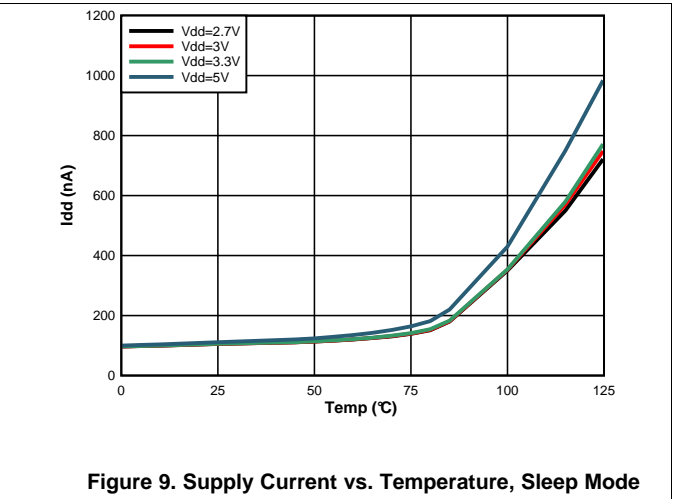
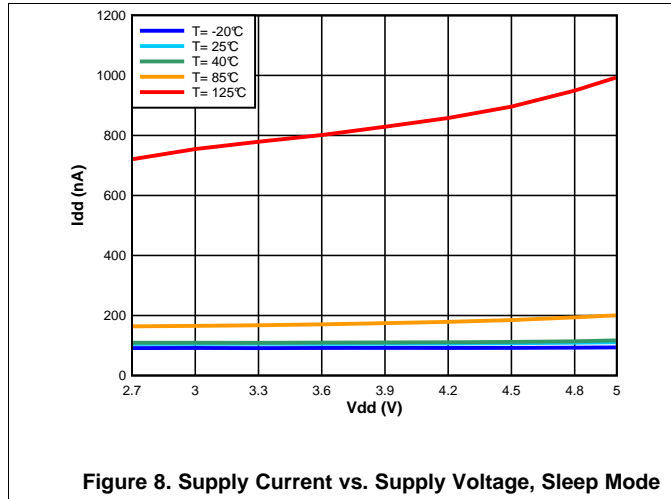

Figure 7. Supply Current vs. Temperature, Temp Measurement

**Typical Characteristics (continued)**

 Unless otherwise noted,  $T_A = 30^\circ\text{C}$ ,  $V_{DD} = 3\text{V}$ .



## 8 Detailed Description

### 8.1 Overview

The HDC1008 is a digital humidity sensor with integrated temperature sensor that provides excellent measurement accuracy at very low power and long term. The sensing element of the HDC1008 is placed on the bottom part of the device, which makes the HDC1008 more robust against dirt, dust, and other environmental contaminants. Measurement results can be read out through the I<sup>2</sup>C compatible interface. Resolution is based on the measurement time and can be 8, 11, or 14 bits for humidity; 11 or 14 bits for temperature.

### 8.2 Functional Block Diagram

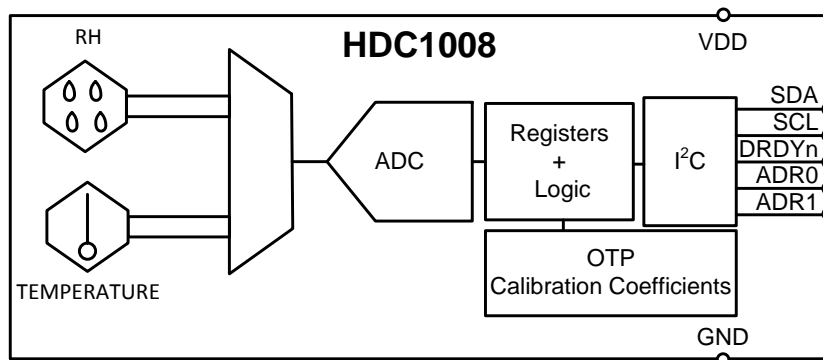

### 8.3 Feature Description

#### 8.3.1 Power Consumption

One of the key features of the HDC1008 is its low power consumption, which makes the device suitable in battery or power harvesting applications. In these applications the HDC1008 spends most of the time in sleep mode; with a typical 110nA of current consumption in sleep mode, the averaged current consumption is minimal. Moreover its low consumption in measurement mode minimizes any self-heating.

#### 8.3.2 Voltage Supply Monitoring

The HDC1008 monitors the supply voltage level and indicates when the voltage supply of the HDC1008 is less than 2.8V. This information is useful in battery-powered systems in order to inform the user to replace the battery. This is reported in the BTST field (register address 0x02:bit[11]) which is updated after POR and after each measurement request.

#### 8.3.3 Heater

The heater is an integrated resistive element that can be used to test the sensor or to drive condensation off the sensor. The heater can be activated using HEAT, bit 13 in Configuration Register. The heater helps in reducing the accumulated offset after long exposure at high humidity conditions.

Once enabled the heater is turned on only in the measurement mode. To have a reasonable increase of the temperature it is suggested to increase the measurement data rate.

### 8.4 Device Functional Modes

The HDC1008 has two modes of operation: sleep mode and measurement mode. After power up, the HDC1008 is in sleep mode. In this mode, the HDC1008 waits for I<sup>2</sup>C input including commands to configure the conversion times, read the status of the battery, trigger a measurement, and read measurements. Once it receives a command to trigger a measurement, the HDC1008 moves from sleep mode to measurement mode. In measurement mode, the HDC1008 acquires the configured measurements and sets the DRDYn line low when the measurement is complete. After completing the measurement and setting DRDYn low, the HDC1008 returns to sleep mode.

## 8.5 Programming

### 8.5.1 I<sup>2</sup>C Serial Bus Address Configuration

To communicate with the HDC1008, the master must first address slave devices via a slave address byte. The slave address byte consists of seven address bits and a direction bit that indicates the intent to execute a read or write operation. The HDC1008 features two address pins to allow up to 4 devices to be addressed on a single bus. [Table 1](#) describes the pin logic levels used to properly connect up to 4 devices. The state of the ADR0 and ADR1 pins is sampled on every bus communication and should be set before any activity on the interface occurs. The address pin is read at the start of each communication event.

**Table 1. HDC1008 ADDRESS**

ADR1	ADR0	ADDRESS (7-bit address)
0	0	1000000
0	1	1000001
1	0	1000010
1	1	1000011

### 8.5.2 I<sup>2</sup>C Interface

The HDC1008 operates only as a slave device on the I<sup>2</sup>C bus interface. It is not allowed to have on the I<sup>2</sup>C bus multiple devices with the same address. Connection to the bus is made via the open-drain I/O lines, SDA, and SCL. The SDA and SCL pins feature integrated spike-suppression filters and Schmitt triggers to minimize the effects of input spikes and bus noise. After power-up, the sensor needs at most 15 ms, to be ready to start RH and temperature measurement. During this power-up time the HDC1008 is only able to provide the content of the serial number registers (0xFB to 0xFF) if requested. After the power-up the sensor is in the sleep mode until a communication or measurement is performed. All data bytes are transmitted MSB first.

#### 8.5.2.1 Serial Bus Address

To communicate with the HDC1008, the master must first address slave devices via a slave address byte. The slave address byte consists of seven address bits, and a direction bit that indicates the intent to execute a read or write operation.

#### 8.5.2.2 Read and Write Operations

Access a particular register on the HDC1008 by writing the appropriate value to the Pointer Register. The pointer value is the first byte transferred after the slave address byte with the R/W bit low. Every write operation to the HDC1008 requires a value for the pointer register (refer to [Figure 10](#)).

When reading from the HDC1008, the last value stored in the pointer by a write operation is used to determine which register is read by a read operation. To change the pointer register for a read operation, a new value must be written to the pointer. This transaction is accomplished by issuing the slave address byte with the R/W bit low, followed by the pointer byte. No additional data is required (refer to [Figure 11](#)).

The master can then generate a START condition and send the slave address byte with the R/W bit high to initiate the read command. Note that register bytes are sent MSB first, followed by the LSB. A write operation in a read-only register such as (DEVICE ID, MANUFACTURER ID, SERIAL ID) returns a NACK after each data byte; read/write operation to unused address returns a NACK after the pointer; a read/write operation with incorrect I<sup>2</sup>C address returns a NACK after the I<sup>2</sup>C address.

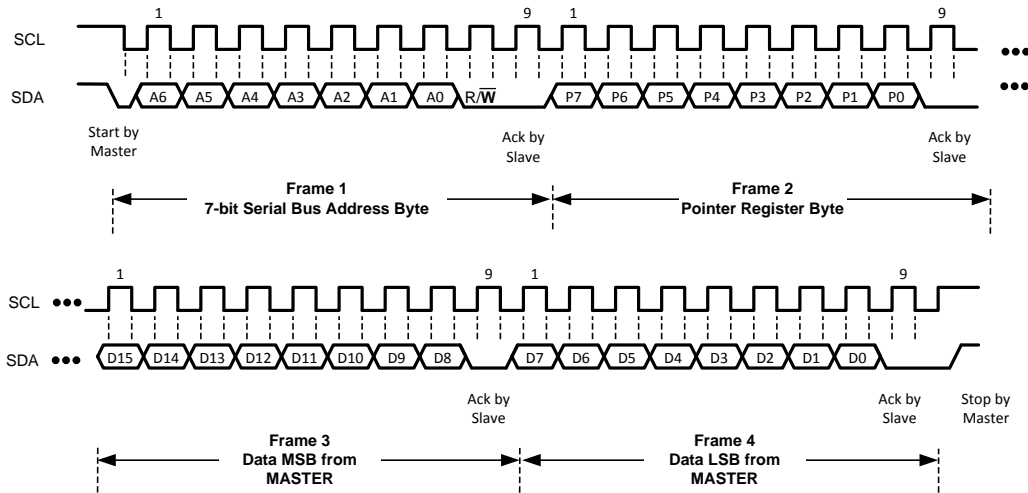

Figure 10. Writing Frame (Configuration Register)

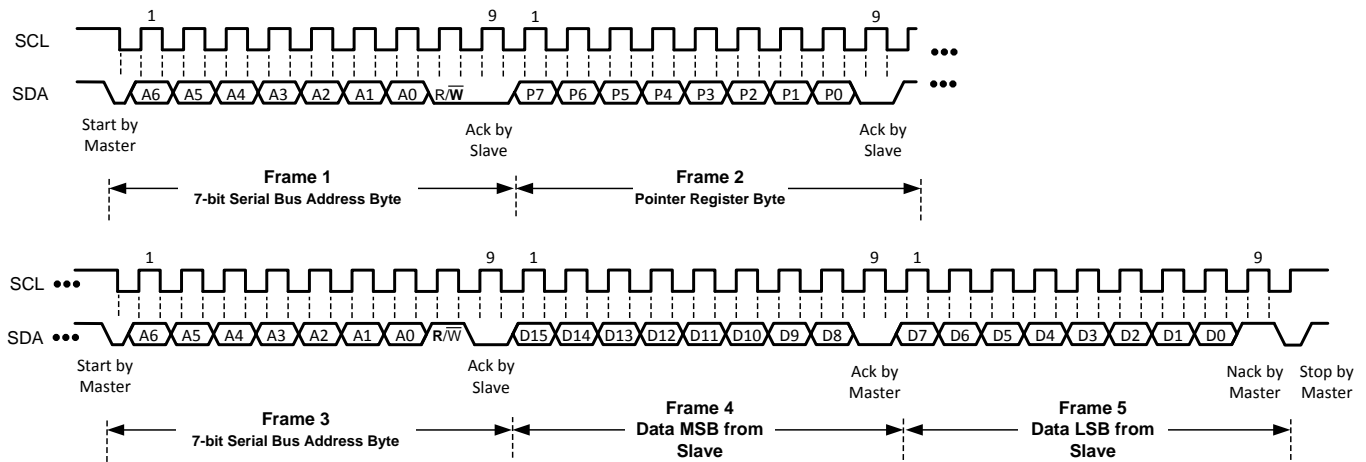

Figure 11. Reading Frame (Configuration Register)

### 8.5.2.3 Device Measurement Configuration

By default the HDC1008 will first perform a temperature measurement followed by a humidity measurement. On power-up, the HDC1008 enters a low power sleep mode and is not actively measuring. Use the following steps to perform a measurement of both temperature and humidity and then retrieve the results:

1. Configure the acquisition parameters in register address 0x02:
  - (a) Set the acquisition mode to measure both temperature and humidity by setting Bit[12] to 1.
  - (b) Set the desired temperature measurement resolution:
    - Set Bit[10] to 0 for 14 bit resolution.
    - Set Bit[10] to 1 for 11 bit resolution.
  - (c) Set the desired humidity measurement resolution:
    - Set Bit[9:8] to 00 for 14 bit resolution.
    - Set Bit[9:8] to 01 for 11 bit resolution.
    - Set Bit[9:8] to 10 for 8 bit resolution.
2. Trigger the measurements by executing a pointer write transaction with the address pointer set to 0x00. Refer to [Figure 12](#).
3. Wait for the measurements to complete, based on the conversion time (refer to [Electrical Characteristics](#) for the conversion time). Alternatively, wait for the assertion of DRDYn.

4. Read the output data:

Read the temperature data from register address 0x00, followed by the humidity data from register address 0x01 in a single transaction as shown in Figure 14. A read operation will return a NACK if the contents of the registers have not been updated as shown in Figure 13.

To perform another acquisition with the same measurement configuration simply repeat steps 2 through 4.

If only a humidity or temperature measurement is desired, the following steps will perform a measurement and retrieve the result:

1. Configure the acquisition parameters in register address 0x02:
  - (a) Set the acquisition mode to independently measure temperature or humidity by setting Bit[12] to 0.
  - (b) For a temperature measurement, set the desired temperature measurement resolution:
    - Set Bit[10] to 0 for 14 bit resolution.
    - Set Bit[10] to 1 for 11 bit resolution.
  - (c) For a humidity measurement, set the desired humidity measurement resolution:
    - Set Bit[9:8] to 00 for 14 bit resolution.
    - Set Bit[9:8] to 01 for 11 bit resolution.
    - Set Bit[9:8] to 10 for 8 bit resolution.
2. Trigger the measurement by executing a pointer write transaction. Refer to Figure 12.
  - Set the address pointer to 0x00 for a temperature measurement.
  - Set the address pointer to 0x01 for a humidity measurement.
3. Wait for the measurement to complete, based on the conversion time (refer to *Electrical Characteristics* for the conversion time). Alternatively, wait for the assertion of DRDYn.
4. Read the output data:

Retrieve the completed measurement result from register address 0x00 or 0x01, as appropriate, as shown in Figure 10. A read operation will return a NACK if the measurement result is not yet available, as shown in Figure 13.

To perform another acquisition with the same measurement configuration repeat steps 2 through 4.

It is possible to read the output registers (addresses 0x00 and 0x01) during an Temperature or Relative Humidity measurement without affecting any ongoing measurement. Note that a write to address 0x00 or 0x01 while a measurement is ongoing will abort the ongoing measurement. If the newest acquired measurement is not read, DRDYn stays low until the next measurement is triggered.

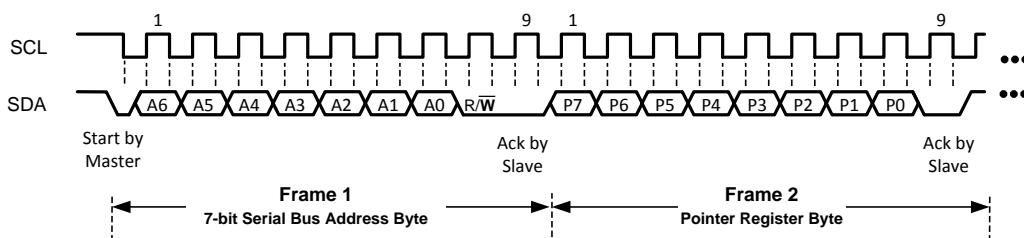

Figure 12. Trigger Humidity/Temperature Measurement

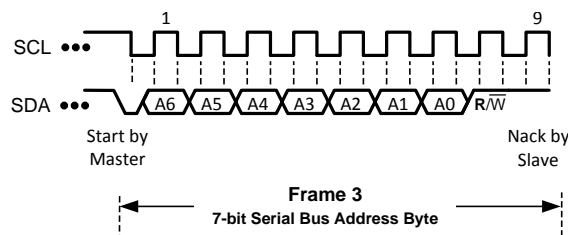

Figure 13. Read Humidity/Temperature Measurement (Data Not Ready)

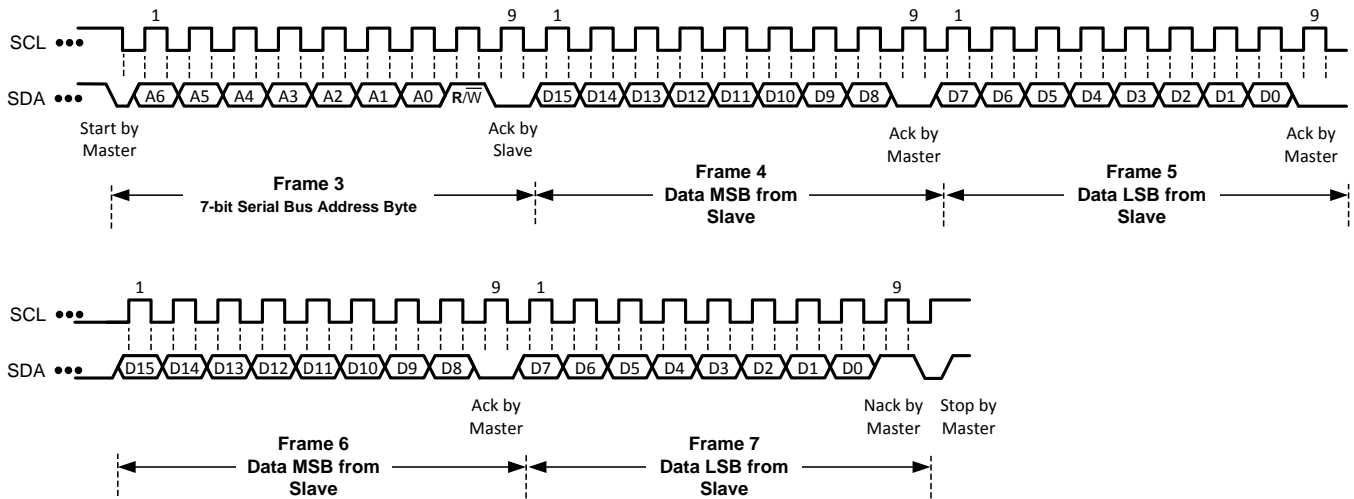

Figure 14. Read Humidity and Temperature Measurement (Data Ready)

## 8.6 Register Map

The HDC1008 contains data registers that hold configuration information, temperature and humidity measurement results, and status information.

**Table 2. Register Map**

POINTER	NAME	RESET VALUE	DESCRIPTION
0x00	Temperature	0x0000	Temperature measurement output
0x01	Humidity	0x0000	Relative Humidity measurement output
0x02	Configuration	0x1000	HDC1008 configuration and status
0xFB	Serial ID	device dependent	First 2 bytes of the serial ID of the part
0xFC	Serial ID	device dependent	Mid 2 bytes of the serial ID of the part
0xFD	Serial ID	device dependent	Last byte bit of the serial ID of the part

Registers from 0x03 to 0xFA are reserved and should not be written.

The HDC1008 has an 8-bit pointer used to address a given data register. The pointer identifies which of the data registers should respond to a read or write command on the two-wire bus. This register is set with every write command. A write command must be issued to set the proper value in the pointer before executing a read command. The power-on reset (POR) value of the pointer is 0x00, which selects a temperature measurement.

### 8.6.1 Temperature Register

The temperature register is a 16-bit result register in binary format (the 2 LSBs D1 and D0 are always 0). The result of the acquisition is always a 14 bit value, while the accuracy is related to the selected conversion time (refer to [Electrical Characteristics](#)). The temperature can be calculated from the output data with:

$$\text{Temperature}(\text{°C}) = \left( \frac{\text{TEMPERATURE}[15:00]}{2^{16}} \right) * 165\text{°C} - 40\text{°C} \quad (1)$$

**Table 3. Temperature Register Description (0x00)**

NAME	REGISTERS		DESCRIPTION
TEMPERATURE	[15:02]	Temperature	Temperature measurement (read only)
	[01:00]	Reserved	Reserved, always 0 (read only)

### 8.6.2 Humidity Register

The humidity register is a 16-bit result register in binary format (the 2 LSBs D1 and D0 are always 0). The result of the acquisition is always a 14 bit value, while the accuracy is related to the selected conversion time (refer to [Electrical Characteristics](#)). The humidity can be calculated from the output data with:

$$\text{Relative Humidity}(\% \text{ RH}) = \left( \frac{\text{HUMIDITY}[15:00]}{2^{16}} \right) * 100\% \text{ RH} \quad (2)$$

**Table 4. Humidity Register Description (0x01)**

NAME	REGISTERS		DESCRIPTION
HUMIDITY	[15:02]	Relative Humidity	Relative Humidity measurement (read only)
	[01:00]	Reserved	Reserved, always 0 (read only)

### 8.6.3 Configuration Register

This register configures device functionality and returns status.

**Table 5. Configuration Register Description (0x02)**

NAME	REGISTERS	DESCRIPTION	
RST	[15]	Software reset bit	0 Normal Operation, this bit self clears
			1 Software Reset
Reserved	[14]	Reserved	0 Reserved, must be 0
HEAT	[13]	Heater	0 Heater Disabled
			1 Heater Enabled
MODE	[12]	Mode of acquisition	0 Temperature or Humidity is acquired.
			1 Temperature and Humidity are acquired in sequence, Temperature first.
BTST	[11]	Battery Status	0 Battery voltage > 2.8V (read only)
			1 Battery voltage < 2.8V (read only)
TRES	[10]	Temperature Measurement Resolution	0 14 bit
			1 11 bit
HRES	[9:8]	Humidity Measurement Resolution	00 14 bit
			01 11 bit
			10 8 bit
Reserved	[7:0]	Reserved	0 Reserved, must be 0

### 8.6.4 Serial Number Registers

These registers contain a 40bit unique serial number for each individual HDC1008.

**Table 6. Serial Number Register Description (0xFB)**

NAME	REGISTERS	DESCRIPTION	
SERIAL ID[39:24]	[15:0]	Serial Id bits	Device Serial Number bits from 39 to 24 (read only)

**Table 7. Serial Number Register Description (0xFC)**

NAME	REGISTERS	DESCRIPTION	
SERIAL ID[23:8]	[15:0]	Serial Id bits	Device Serial Number bits from 23 to 8 (read only)

**Table 8. Serial Number Register Description (0xFD)**

NAME	REGISTERS	DESCRIPTION	
SERIAL ID[7:0]	[15:7]	Serial ID bits	Device Serial Number bits from 7 to 0 (read only)
	[6:0]	Reserved	Reserved, always 0 (read only)

## 9 Application and Implementation

### NOTE

Information in the following applications sections is not part of the TI component specification, and TI does not warrant its accuracy or completeness. TI's customers are responsible for determining suitability of components for their purposes. Customers should validate and test their design implementation to confirm system functionality.

### 9.1 Application Information

A HVAC or Thermostat are based on environmental sensors and a micro-controller which acquires data from humidity sensors and temperature sensors and controls the heating/cooling system. The collected data are then showed on a display that can be easily controlled by the micro controller. Based on data from the humidity and temperature sensor, the heating/cooling system then maintains the environment at customer-defined preferred conditions.

### 9.2 Typical Application

In a battery-powered HVAC or thermostat, one of the key parameters in the selection of components is the power consumption. The HDC1008, with its 1.2 $\mu$ A of current consumption (average consumption over 1s for RH and Temperature measurements) in conjunction with an MSP430 represents an excellent choice for the low power consumption, which extends the battery life. A system block diagram of a battery powered HVAC or Thermostat is shown in [Figure 15](#).

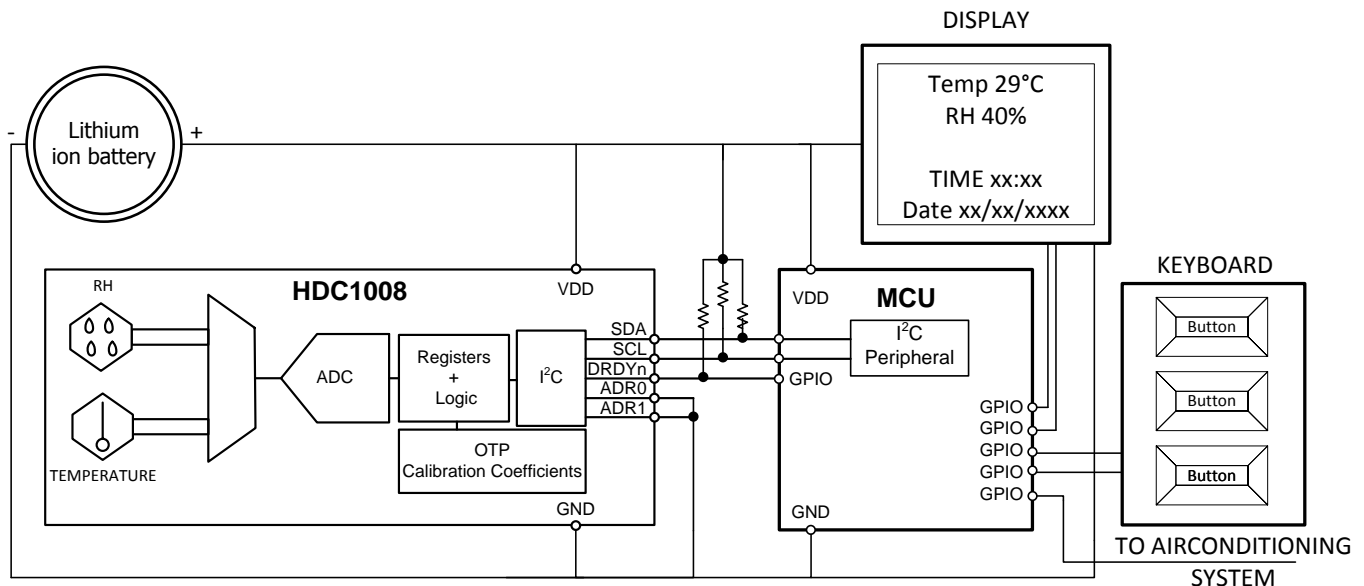

**Figure 15. Typical Application Schematic HVAC**

#### 9.2.1 Design Requirements

In order to correctly sense the ambient temperature and humidity, the HDC1008 should be positioned away from heat sources on the PCB. Generally, it should not be close to the LCD and battery. Moreover, to minimize any self-heating of the HDC1008 it is recommended to acquire at a maximum sample rate of 1sps (RH + Temp). In home systems, humidity and the temperature monitoring rates of less than 1sps (even 0.5sps or 0.2sps) can be still effective.



## Typical Application (continued)

### 9.2.2 Detailed Design Procedure

When a circuit board layout is created from the schematic shown in [Figure 15](#), a small circuit board is possible. The accuracy of a RH and temperature measurement depends on the sensor accuracy and the setup of the sensing system. The HDC1008 samples relative humidity and temperature in its immediate environment, it is therefore important that the local conditions at the sensor match the monitored environment. Use one or more openings in the physical cover of the HVAC to obtain a good airflow even in static conditions. Refer to the layout below ([Figure 19](#)) for a PCB layout which minimizes the thermal mass of the PCB in the region of the HDC1008, which can improve measurement response time and accuracy.

### 9.2.3 Application Curve

The data showed below have been acquired with the HDC1000EVM populated with HDC1008 . The environment conditions have been evaluated in a humidity chamber.

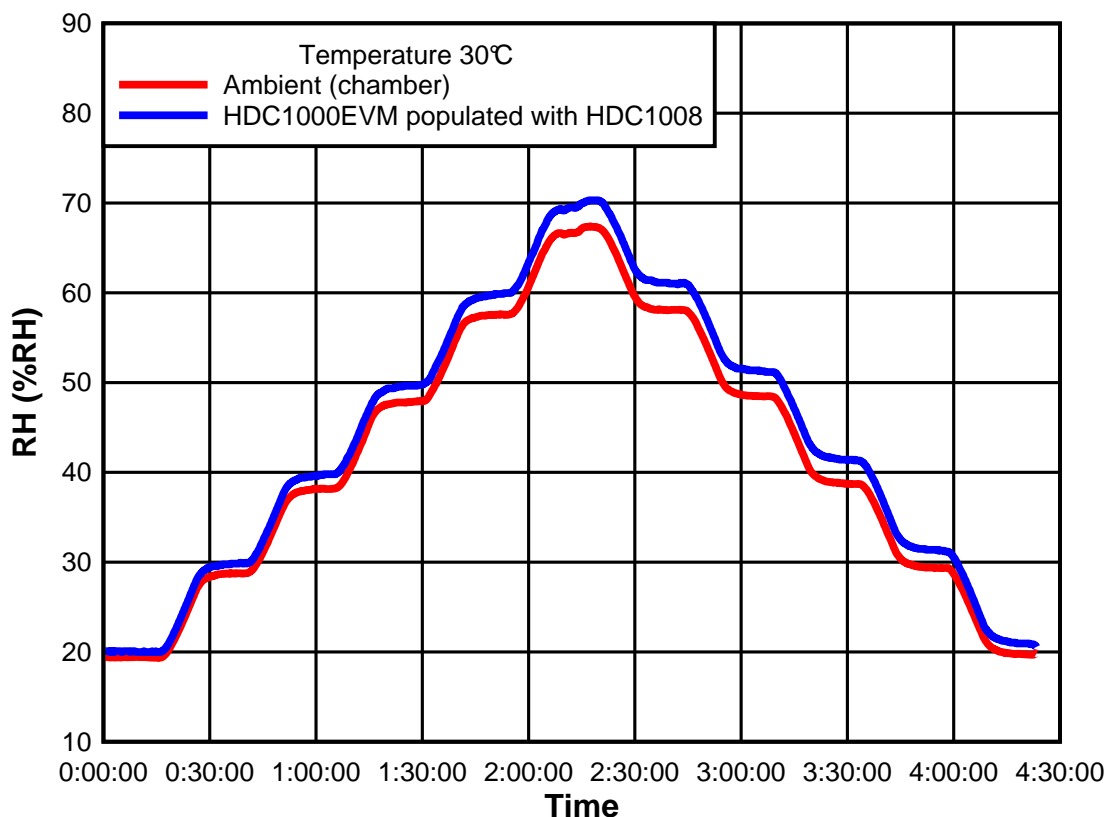

Figure 16. RH vs. Time

## 9.3 Do's and Don'ts

### 9.3.1 Soldering

For soldering HDC1008, standard reflow soldering ovens may be used. The sensor is qualified to withstand soldering profile according to IPC/JEDEC J-STD-020 with peak temperatures at 260 °C. Refer to the document [SNVA009](#) for more details on the DSBGA package. In the document refer to DSBGA package with bump size 0.5mm pitch and 0.32mm diameter.

When soldering the HDC1008 it is mandatory to use no-clean solder paste and no board wash shall be applied. The HDC1008 should be limited to a single IR reflow and no rework is recommended.

### 9.3.2 Hydration Procedure

The HDC1008 may exhibit a negative RH offset due to either the thermal stress of soldering or settling of the RH sensor. It will slowly settle when the humidity sensor is exposed to ambient conditions. If faster settling is required, the following hydration process can be used:

**Store the PCB containing the HDC1008 at 85% RH and 85 °C for 12 hours.**

### 9.3.3 Chemical Exposure

The humidity sensor is not a standard IC and therefore should not be exposed to volatile chemicals such as solvents or other organic compounds. If any type of protective coating must be applied to the circuit board, the sensor must be protected during the coating process.

## 10 Power Supply Recommendations

The HDC1008 require a voltage supply within 2.7V and 5.5V. A multilayer ceramic bypass X7R capacitor of 0.1µF between VDD and GND pin is recommended.

## 11 Layout

### 11.1 Layout Guidelines

The Relative Humidity sensor element is located on the bottom side of the package. It is positioned between the two rows of bumps.

It is recommended to not route any traces below the sensor element. Moreover, the external components, such as pull-up resistors and bypass capacitors need to be placed next to the 2 rows of bumps or on the bottom side of the PCB in order to guarantee a good air flow.

#### 11.1.1 Surface Mount

Two types of PCB land patterns are used for surface mount packages:

1. Non-solder mask defined (NSMD)
2. Solder mask defined (SMD)

Pros and cons of NSMD and SMD:

1. The NSMD configuration is preferred due to its tighter control of the copper etch process and a reduction in the stress concentration points on the PCB side compared to SMD configuration.
2. A copper layer thickness of less than 1 oz. is recommended to achieve higher solder joint stand-off. A 1 oz. (35 micron) or greater copper thickness causes a lower effective solder joint stand-off, which may compromise solder joint reliability.
3. For the NSMD pad geometry, the trace width at the connection to the land pad should not exceed 2/3 of the pad diameter.

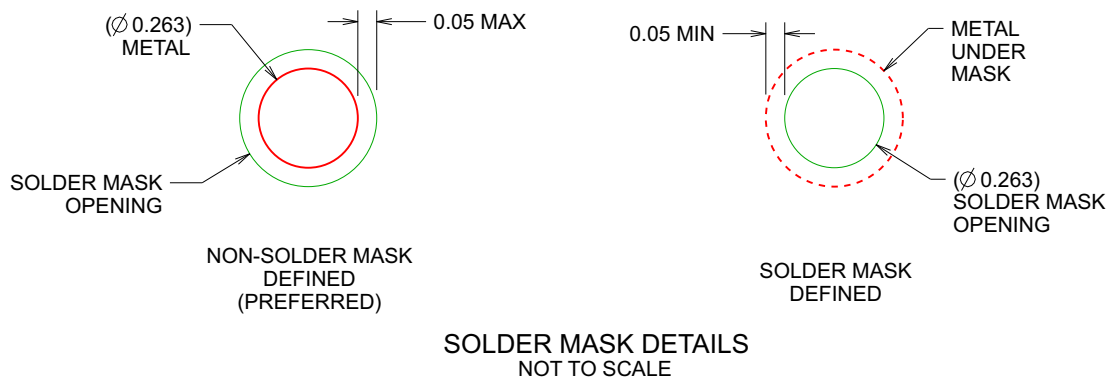

**Figure 17. Solder Mask**

**Layout Guidelines (continued)**
**11.1.2 Stencil Printing Process**

1. Use laser cutting followed by electro-polishing for stencil fabrication.
2. If possible, offset apertures from land pads to maximize separation and minimize possibility of bridging for DSBGA packages.
3. Use Type 3 (25 to 45 micron particle size range) or finer solder paste for printing.

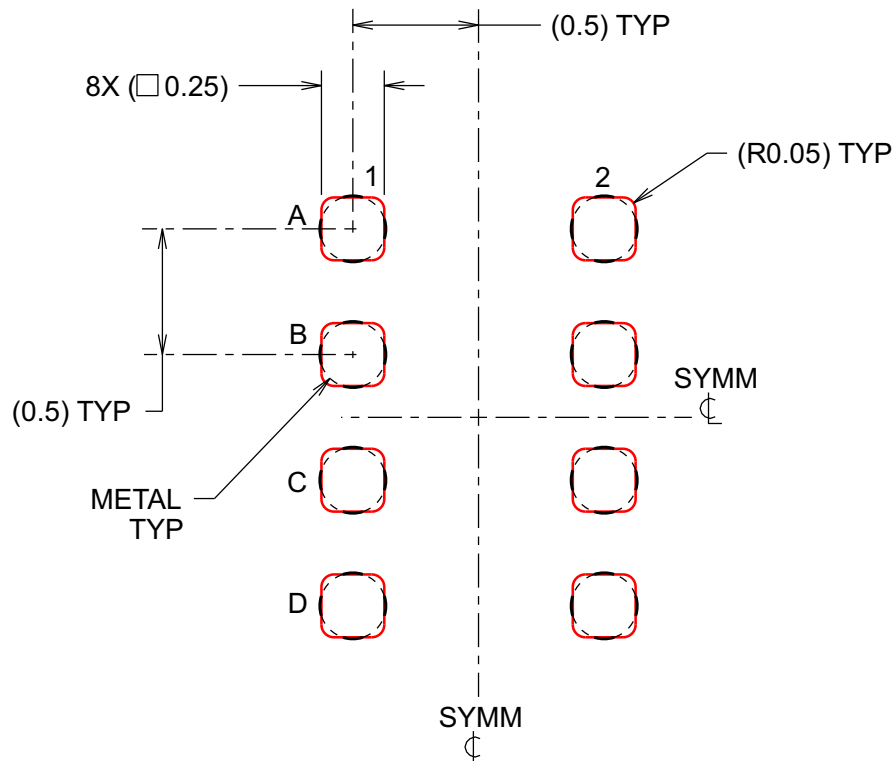

**SOLDER PASTE EXAMPLE**  
 BASED ON 0.1mm THICK STENCIL  
 SCALE:25X

**Figure 18. Solder Paste**

## 11.2 Layout Example

The only component next to the device is the supply bypass capacitor. Since the relative humidity is dependent on the temperature, the HDC1008 should be positioned away from hot points present on the board such as battery, display or micro-controller. Slots around the device can be used to reduce the thermal mass for a quicker response to environmental changes.

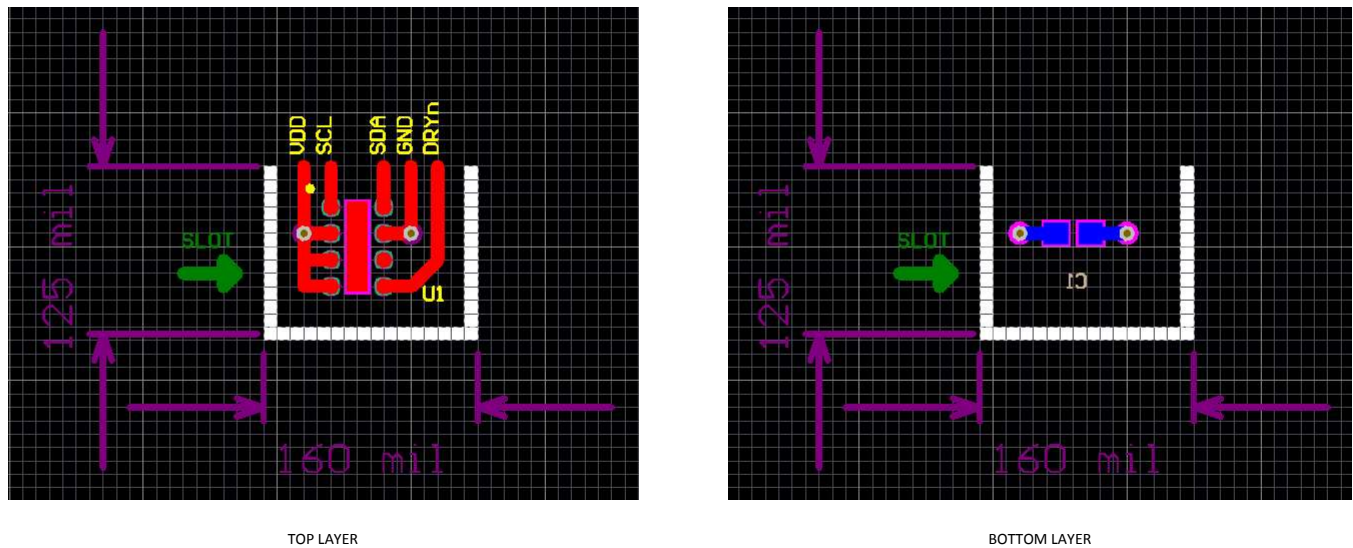

Figure 19. HDC1008 Layout

## 12 Device and Documentation Support

### 12.1 Documentation Support

#### 12.1.1 Related Documentation

*HDC1000 Texas Instruments Humidity Sensors*, [SNAA216](#)

*AN-1112 Micro SMD Wafer Level Chip Scale Package*, [SNVA009](#)

### 12.2 Community Resources

The following links connect to TI community resources. Linked contents are provided "AS IS" by the respective contributors. They do not constitute TI specifications and do not necessarily reflect TI's views; see TI's [Terms of Use](#).

**TI E2E™ Online Community** *TI's Engineer-to-Engineer (E2E) Community*. Created to foster collaboration among engineers. At [e2e.ti.com](#), you can ask questions, share knowledge, explore ideas and help solve problems with fellow engineers.

**Design Support** *TI's Design Support* Quickly find helpful E2E forums along with design support tools and contact information for technical support.

### 12.3 Trademarks

E2E is a trademark of Texas Instruments.  
All other trademarks are the property of their respective owners.

### 12.4 Electrostatic Discharge Caution



These devices have limited built-in ESD protection. The leads should be shorted together or the device placed in conductive foam during storage or handling to prevent electrostatic damage to the MOS gates.

### 12.5 Glossary

[SLYZ022](#) — *TI Glossary*.

This glossary lists and explains terms, acronyms, and definitions.

## 13 Mechanical, Packaging, and Orderable Information

The following pages include mechanical, packaging, and orderable information. This information is the most current data available for the designated devices. This data is subject to change without notice and revision of this document. For browser-based versions of this data sheet, refer to the left-hand navigation.

**PACKAGING INFORMATION**

Orderable Device	Status (1)	Package Type	Package Drawing	Pins	Package Qty	Eco Plan (2)	Lead finish/ Ball material (6)	MSL Peak Temp (3)	Op Temp (°C)	Device Marking (4/5)	Samples
HDC1008YPAR	NRND	DSBGA	YPA	8	3000	RoHS & Green	SAC405 SNAGCU	Level-1-260C-UNLIM	-40 to 125	GK	
HDC1008YPAT	NRND	DSBGA	YPA	8	250	RoHS & Green	SAC405 SNAGCU	Level-1-260C-UNLIM	-40 to 125	GK	

(1) The marketing status values are defined as follows:

**ACTIVE:** Product device recommended for new designs.

**LIFEBUY:** TI has announced that the device will be discontinued, and a lifetime-buy period is in effect.

**NRND:** Not recommended for new designs. Device is in production to support existing customers, but TI does not recommend using this part in a new design.

**PREVIEW:** Device has been announced but is not in production. Samples may or may not be available.

**OBSELETE:** TI has discontinued the production of the device.

(2) **RoHS:** TI defines "RoHS" to mean semiconductor products that are compliant with the current EU RoHS requirements for all 10 RoHS substances, including the requirement that RoHS substance do not exceed 0.1% by weight in homogeneous materials. Where designed to be soldered at high temperatures, "RoHS" products are suitable for use in specified lead-free processes. TI may reference these types of products as "Pb-Free".

**RoHS Exempt:** TI defines "RoHS Exempt" to mean products that contain lead but are compliant with EU RoHS pursuant to a specific EU RoHS exemption.

**Green:** TI defines "Green" to mean the content of Chlorine (Cl) and Bromine (Br) based flame retardants meet JS709B low halogen requirements of <=1000ppm threshold. Antimony trioxide based flame retardants must also meet the <=1000ppm threshold requirement.

(3) MSL, Peak Temp. - The Moisture Sensitivity Level rating according to the JEDEC industry standard classifications, and peak solder temperature.

(4) There may be additional marking, which relates to the logo, the lot trace code information, or the environmental category on the device.

(5) Multiple Device Markings will be inside parentheses. Only one Device Marking contained in parentheses and separated by a "~" will appear on a device. If a line is indented then it is a continuation of the previous line and the two combined represent the entire Device Marking for that device.

(6) Lead finish/Ball material - Orderable Devices may have multiple material finish options. Finish options are separated by a vertical ruled line. Lead finish/Ball material values may wrap to two lines if the finish value exceeds the maximum column width.

**Important Information and Disclaimer:**The information provided on this page represents TI's knowledge and belief as of the date that it is provided. TI bases its knowledge and belief on information provided by third parties, and makes no representation or warranty as to the accuracy of such information. Efforts are underway to better integrate information from third parties. TI has taken and continues to take reasonable steps to provide representative and accurate information but may not have conducted destructive testing or chemical analysis on incoming materials and chemicals. TI and TI suppliers consider certain information to be proprietary, and thus CAS numbers and other limited information may not be available for release.

In no event shall TI's liability arising out of such information exceed the total purchase price of the TI part(s) at issue in this document sold by TI to Customer on an annual basis.

**TAPE AND REEL INFORMATION**

**QUADRANT ASSIGNMENTS FOR PIN 1 ORIENTATION IN TAPE**

\*All dimensions are nominal

Device	Package Type	Package Drawing	Pins	SPQ	Reel Diameter (mm)	Reel Width W1 (mm)	A0 (mm)	B0 (mm)	K0 (mm)	P1 (mm)	W (mm)	Pin1 Quadrant
HDC1008YPAR	DSBGA	YPA	8	3000	178.0	8.4	1.68	2.13	0.76	4.0	8.0	Q1
HDC1008YPAT	DSBGA	YPA	8	250	178.0	8.4	1.68	2.13	0.76	4.0	8.0	Q1



**TAPE AND REEL BOX DIMENSIONS**

\*All dimensions are nominal

Device	Package Type	Package Drawing	Pins	SPQ	Length (mm)	Width (mm)	Height (mm)
HDC1008YPAR	DSBGA	YPA	8	3000	210.0	185.0	35.0
HDC1008YPAT	DSBGA	YPA	8	250	210.0	185.0	35.0

YPA0008

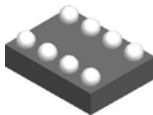

DSBGA - 0.675 mm max height

DIE SIZE BALL GRID ARRAY

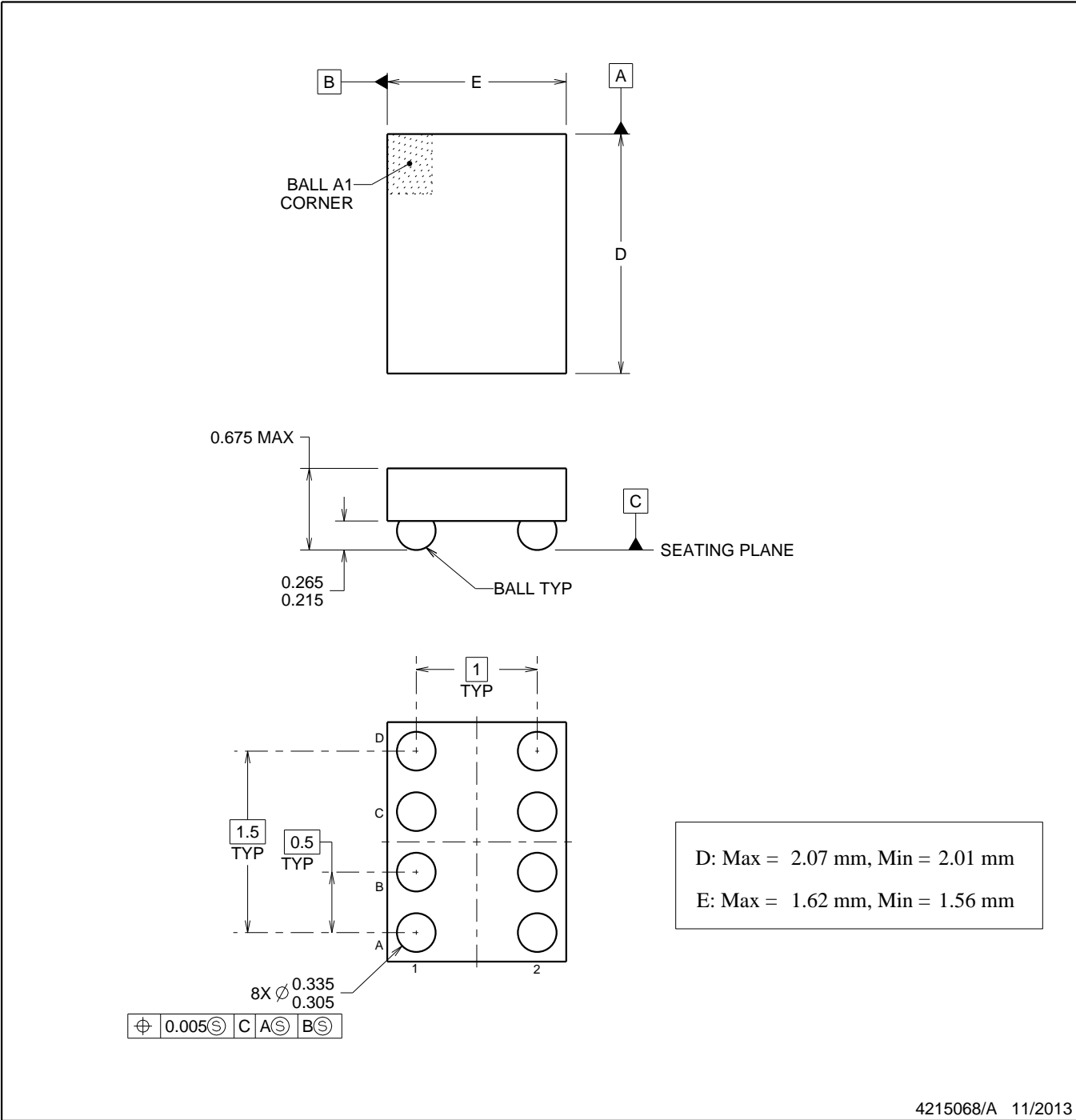

NOTES:

1. All linear dimensions are in millimeters. Dimensions in parenthesis are for reference only. Dimensioning and tolerancing per ASME Y14.5M.
2. This drawing is subject to change without notice.

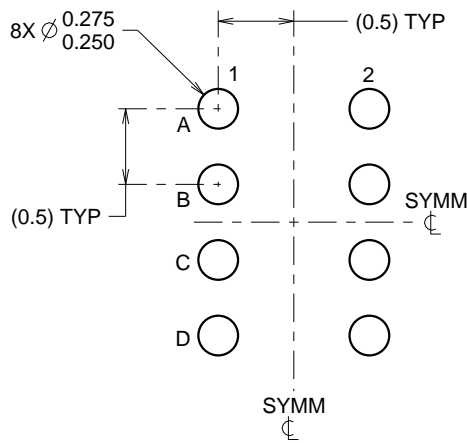

LAND PATTERN EXAMPLE  
SCALE:20X

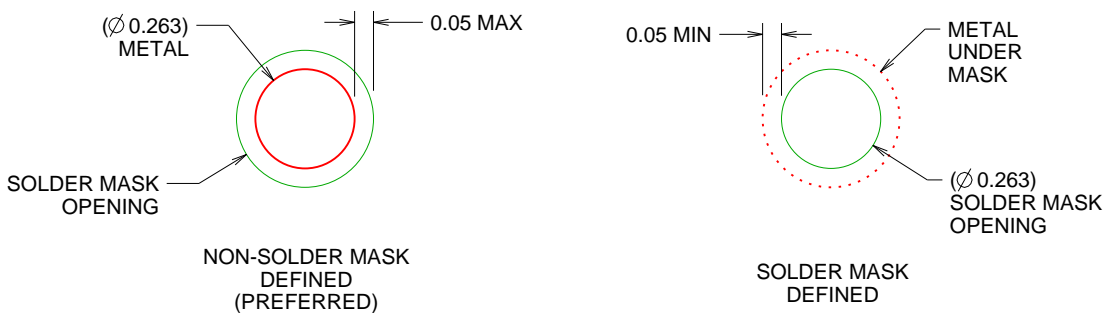

SOLDER MASK DETAILS  
NOT TO SCALE

4215068/A 11/2013

NOTES: (continued)

- 3. Final dimensions may vary due to manufacturing tolerance considerations and also routing constraints. See Texas Instruments Literature No. SBVA017 ([www.ti.com/lit/sbva017](http://www.ti.com/lit/sbva017)).

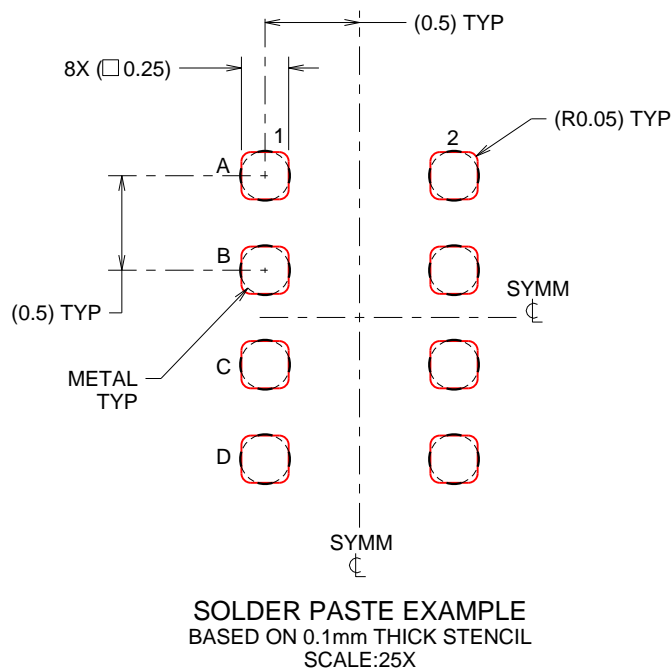

4215068/A 11/2013

NOTES: (continued)

4. Laser cutting apertures with trapezoidal walls and rounded corners may offer better paste release.

## IMPORTANT NOTICE AND DISCLAIMER

TI PROVIDES TECHNICAL AND RELIABILITY DATA (INCLUDING DATA SHEETS), DESIGN RESOURCES (INCLUDING REFERENCE DESIGNS), APPLICATION OR OTHER DESIGN ADVICE, WEB TOOLS, SAFETY INFORMATION, AND OTHER RESOURCES "AS IS" AND WITH ALL FAULTS, AND DISCLAIMS ALL WARRANTIES, EXPRESS AND IMPLIED, INCLUDING WITHOUT LIMITATION ANY IMPLIED WARRANTIES OF MERCHANTABILITY, FITNESS FOR A PARTICULAR PURPOSE OR NON-INFRINGEMENT OF THIRD PARTY INTELLECTUAL PROPERTY RIGHTS.

These resources are intended for skilled developers designing with TI products. You are solely responsible for (1) selecting the appropriate TI products for your application, (2) designing, validating and testing your application, and (3) ensuring your application meets applicable standards, and any other safety, security, regulatory or other requirements.

These resources are subject to change without notice. TI grants you permission to use these resources only for development of an application that uses the TI products described in the resource. Other reproduction and display of these resources is prohibited. No license is granted to any other TI intellectual property right or to any third party intellectual property right. TI disclaims responsibility for, and you will fully indemnify TI and its representatives against, any claims, damages, costs, losses, and liabilities arising out of your use of these resources.

TI's products are provided subject to [TI's Terms of Sale](#) or other applicable terms available either on [ti.com](https://www.ti.com) or provided in conjunction with such TI products. TI's provision of these resources does not expand or otherwise alter TI's applicable warranties or warranty disclaimers for TI products.

TI objects to and rejects any additional or different terms you may have proposed.

Mailing Address: Texas Instruments, Post Office Box 655303, Dallas, Texas 75265  
Copyright © 2023, Texas Instruments Incorporated