

FYL-3019EGC1A

Features:

- General purpose leads
- RoHs compliant.

Descriptions:

- Dice material E: GaP
G: GaP
- Emitting Color E: orange
G: Yellow Green
- Device Outline: $\Phi 3\text{mm}$ Round Type.
- Lens Type: water clear.

Radiation pattern.

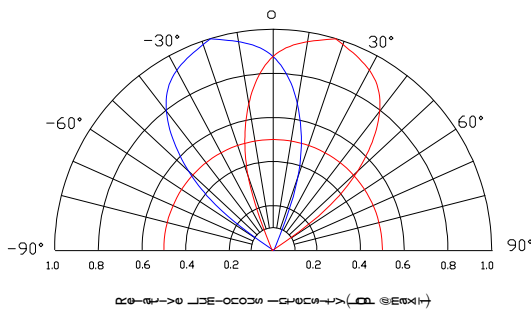

Package configuration

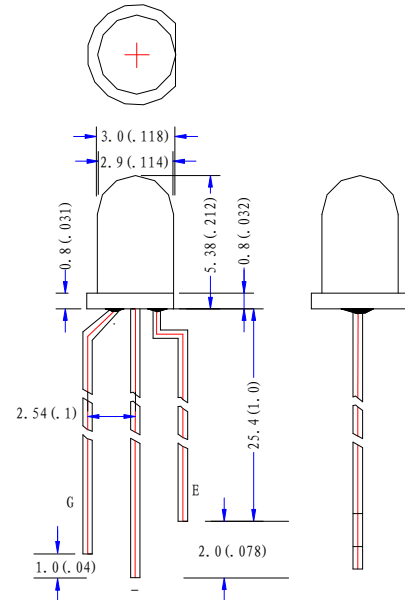

- ◆ All dimensions are millimeters (inches)
- ◆ Tolerance is $\pm 0.25\text{mm}$ (.010") unless otherwise noted.

Absolute maximum ratings ($T_a = 25^\circ\text{C}$)

Parameter	MAX.		Unit
Power Dissipation	E	80	mW
	G	80	
Peak Forward Current (1/10 Duty Cycle, 0.1ms Pulse Width)	100		mA
Continuous Forward Current	30		mA
Derating Linear From 50°C	0.4		mA/ $^\circ\text{C}$
Reverse Voltage	5		V
Operating Temperature Range	-30 $^\circ\text{C}$ to +80 $^\circ\text{C}$		
Storage Temperature Range	-40 $^\circ\text{C}$ to +100 $^\circ\text{C}$		
Lead Soldering Temperature [4mm (.157") From Body]	260 $^\circ\text{C}$ for 5 Seconds		

Electrical and optical characteristics(Ta=25 °c)

Parameter	Symbol	Min.	Typ.	Max.	Unit	Test Condition
Luminous Intensity	I _v	E	-	100	-	mcd
		G	-	130	-	
Viewing Angle	2θ _{1/2}	E	-	40	-	Deg
		G	-	40	-	
Peak Emission Wavelength	λ _p	E	620	625	630	nm
		G	563	568	573	
Dominant Wavelength	λ _d	E	15	620	625	nm
		G	567	572	577	
Spectral Line Half-Width	Δλ	E	10	15	20	nm
		G	15	20	25	
Forward Voltage	V _F	E	1.6	2.0	2.4	V
		G	1.8	2.3	2.5	
Reverse Current	I _R		-	10	uA	V _R =5V

Typical Electrical Characteristics Curves (25 °c Ambient Temperature Unless Otherwise Noted)

Spectral Reduance

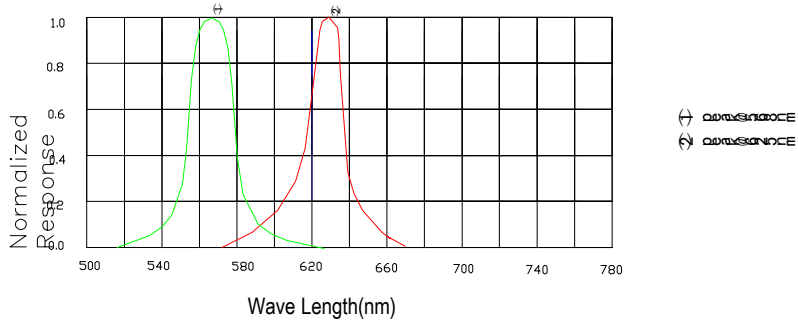

Forward Current Vs Forward Voltage

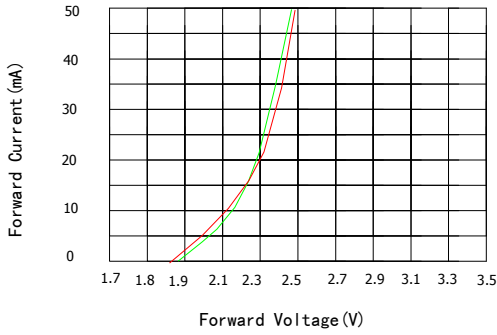

Relative Luminous intensity vs Forward current

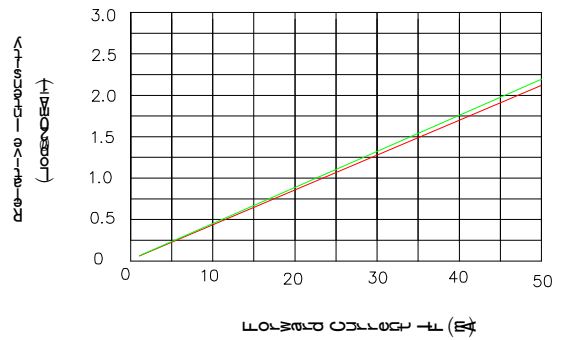

Forward Current Derating Curve

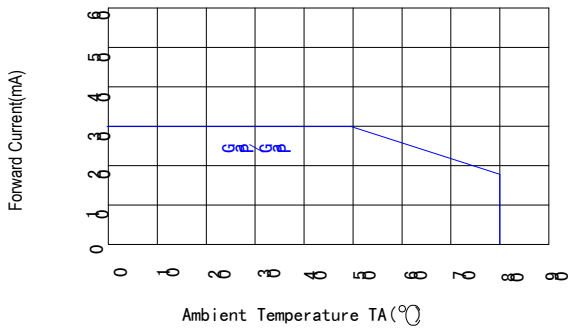

Luminous Intensity Vs Ambient Temperature

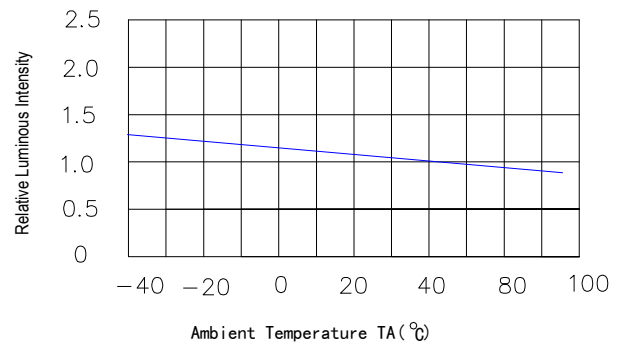

LAMP PACKING.

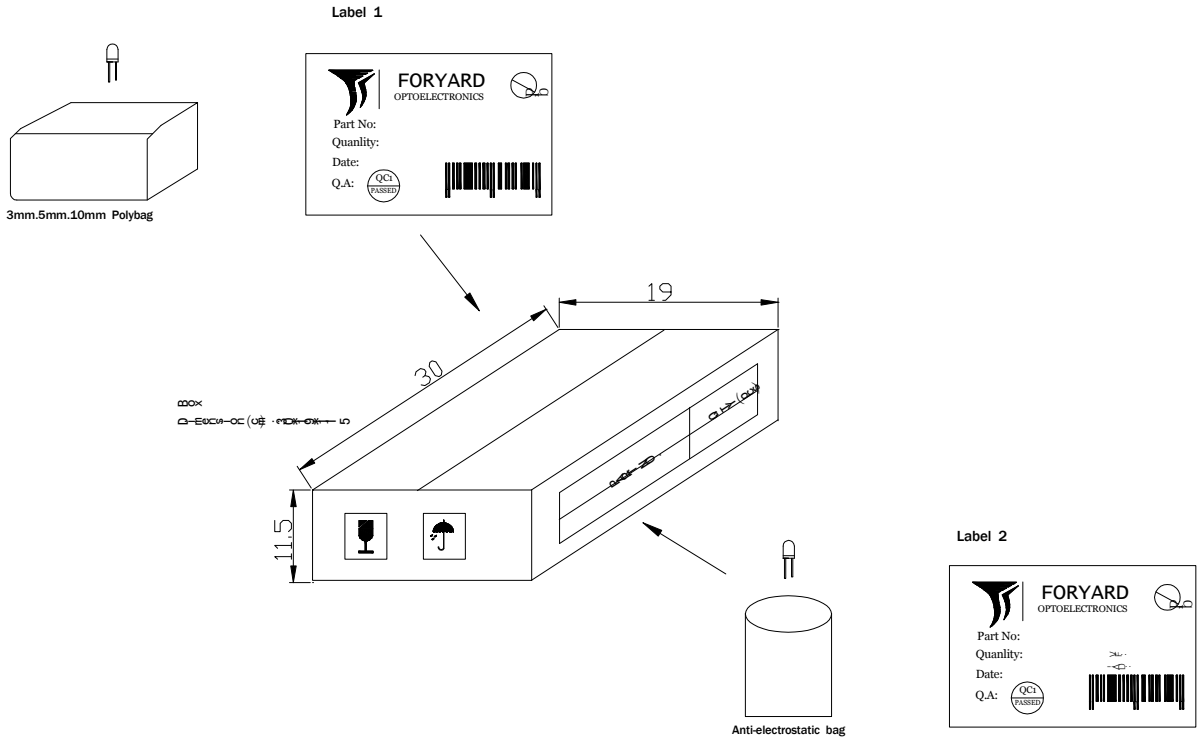

DEVICE	QTY/polybag(pcs)	Polybag/box A	Fig
5mm(T-1 3/4)	1000	8 bags	Label 1
3mm(T-1)	1000	10 bags	Label 1
10mm(T-1)	250	8 bags	Label 1
Blue/Green/White	500	8 bags	Label 2

CARTON
Dimension(cm):39*32*38

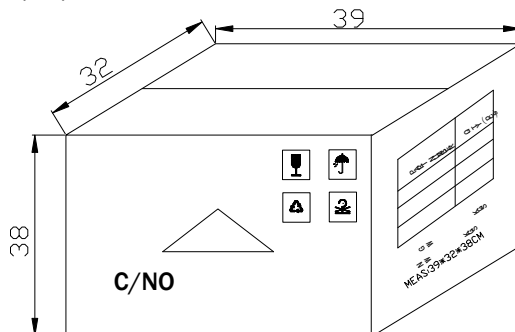

6 Boxes/Carton
5mm:48,000pcs
3mm:60,000pcs
10mm:12,000pcs
Blue/Pure Green/bluish Green
/White:24,000pcs