

RoHS

Specification

规格书

Customer Name :

客户名称 : _____

Customer P/N :

客户品号 : _____

Factory P/N : **HL-EMC-5050D90W-B1C8-S1-HR3-Y**

公司品号 : _____

Sending Date :

送样日期 : _____

Client approval 客户审核		Hongli approval 鸿利智汇审核		
Approval 核准	Audit 确认	Audit 确认		Confirmation 制作
		Sales department 营销中心	Quality department 品质部	Engineering technology centre 工程技术中心
				 
<input type="checkbox"/> Qualified 接受 <input type="checkbox"/> Disqualified 不接受		DATE: 日期: _____		

Adr : No.1,Xianke Yi Road,Huadong Town,Huadu District,Guangzhou,China

地址: 中国广州市花都区花东镇先科一路1号

Tel/电话 : 020-86733333

Fax/传真 : 020-86733883 86733938 86733265

Web/网址 : www.honglitronic.com

注:1. 此规格书以中英文方式书写,若有冲突以中文版本为准.

2. 此规格书的最终解释权归鸿利智汇集团股份有限公司

3. 此规格书的有效期限为两年,自盖章或签字之日起计算,期满时双方可以续签协议,但应采用书面形式

HL-EMC-5050D90W-B1C8-S1-HR3-Y

Features(特征)

- PLCC-2 Package.(PLCC-2 封装)
- Extremely wide viewing angle. (宽的发光角度)
- Suitable for all SMT assembly and solder process. (适用于所有的SMT组装和焊接工艺)
- Available on tape and reel. (适用于载带及卷轴)
- Moisture sensitivity level: Level 4. (防潮等级 Level 4)
- Package:2000pcs/reel..(包装每卷2000PCS)

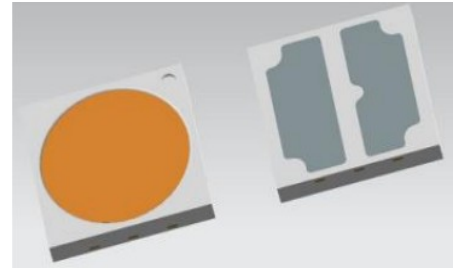

Description (描述)

The White LED which was fabricated using a blue chip and the phosphor
白光LED由蓝光芯片与荧光粉激发而成
After the product life cycle for recycling
产品生命周期后进行回收处理



ATTENTION
OBSERVE PRECAUTIONS
FOR HANDLING
ELECTROSTATIC
DISCHARGE
SENSITIVE
DEVICES

注意：操作时应注意静电敏感
释放设备装置

Package Dimensions (封装尺)

Applications (应用)

- Optical indicator (光学指示)
- Indoor display (室内显示)
- Automotive lighting (汽车照明)
- Backlight for LCD, switch and Symbol, display

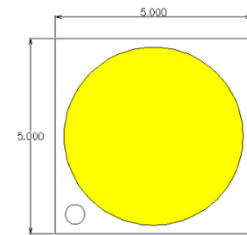

Recommended Soldering Pattern (建议焊盘尺寸图)

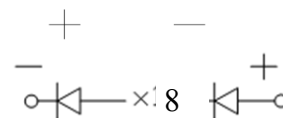
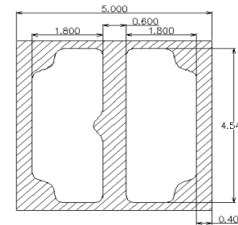
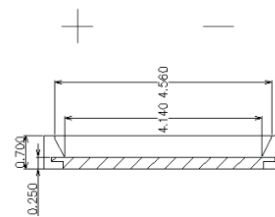
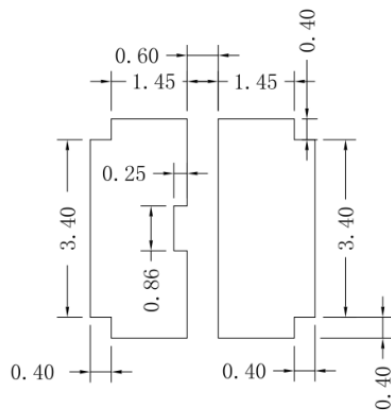

Notes: (备注)

1. All dimension units are millimeters. (所有标注尺寸单位为毫米)
2. All dimension tolerance is $\pm 0.15\text{mm}$ unless otherwise noted. (除特别标注外, 所有尺寸允许公差 $\pm 0.15\text{mm}$)

HL-EMC-5050D90W-B1C8-S1-HR3-Y

Selection Guide (选择指南)

Part No. 型号	Chip Materials 芯片材料	Lens Type 胶体类型
HL-EMC-5050D90W-B1C8-S1-HR3-Y	InGaN	Yellow Diffused

Mass Production list (批量生产目录)

Part No. 型号	CCT (K) Min	CCT (K) Typ	CCT (K) Max	Φ (lm) Min	Φ (lm) Typ	Φ (lm) Max	Test Con- ditions 测试条件
HL-EMC-5050D90W-B1C8-S1-HR3-Y	2550	2700	2800	670	720	770	IF=200mA
	2875	3000	3225	690	740	790	IF=200mA
	3750	4000	4250	710	760	810	IF=200mA
	4650	5000	5350	730	780	830	IF=200mA
	6050	6500	6850	730	780	830	IF=200mA

Electrical / Optical Characteristics at Ta=25°C 电性与光学特性

Parameter (参数)	Symbol (符号)	Min. (最小)	Typ. (平均)	Max. (最大)	Units (单位)	Test Conditions 测试条件
Forward Voltage 正向电压	VF	23	25	27	V	IF=200mA
Viewing Angle 角度	2θ1/2	--	120	--	Deg	IF=200mA
Color Rendering Index 显色性指数	Ra	80	-	--	--	IF=200mA
Thermal Resistance (Junction / Soldering point) 热阻	Rθjc	--	6.05	--	°C/W	IF=200mA

Note:(备注)

- 2θ1/2 is the angle from optical centerline where the luminous intensity is 1/2 the optical centerline value.
2θ1/2 是半值角, 指光强是光学中心线光强的1/2处到光学中心线的角度
- The above luminous flux measurement allowance tolerance is ±5%.
上述光通量的测试允许公差为±5%
- The above Color Rendering Index measurement allowance tolerance is ±2
以上显色性指数的测试允许公差为±2
- The above forward voltage measurement allowance tolerance is ±2%.
以上所示电压测量误差±2%
- The above color coordinates measurement allowance tolerance is ±0.01.

HL-EMC-5050D90W-B1C8-S1-HR3-Y

Absolute Maximum Ratings at Ta=25°C 绝对最大额定值

Parameter (参数)	Symbol (符号)	Rating (值)	Units (单位)
Power Dissipation (功耗)	Pd	5.4	W
Forward Current (正向电流)	IF	240	mA
Power dissipation Reverse voltage (功耗反向电压)	Vr	40	V
Reverse Current 反向电流	IR	10	μA
Electrostatic Discharge (HBM) (静电)	ESD	2000	V
TS Temperature (TS 温度)	TS	105	°C
Storage Temperature (保存温度)	Tstg	-35 ~ +85	°C
Junction Temperature(结温)	Tj	125	°C

HL-EMC-5050D90W-B1C8-S1-HR3-Y

Typical optical characteristics curves 光电特性曲线

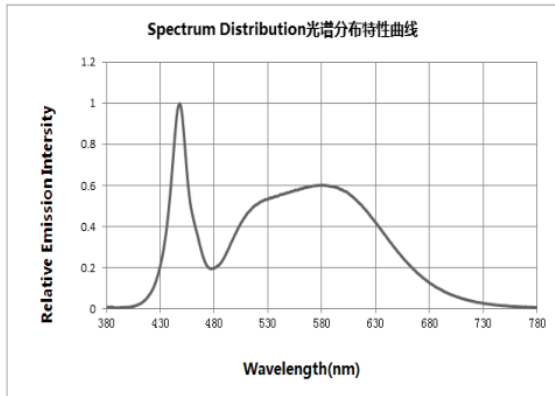
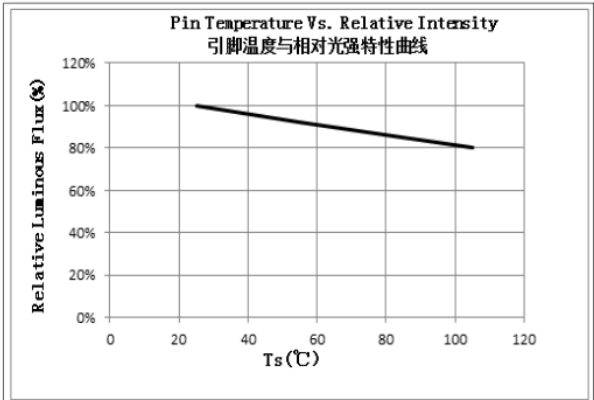
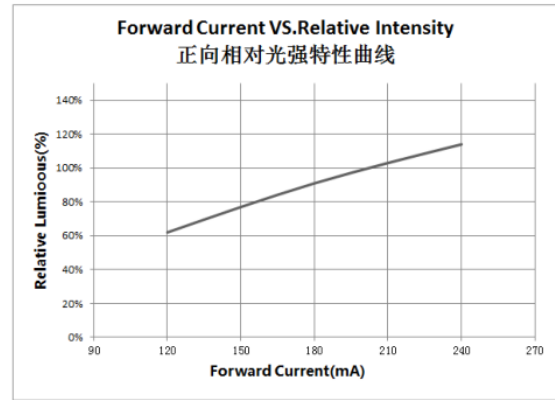
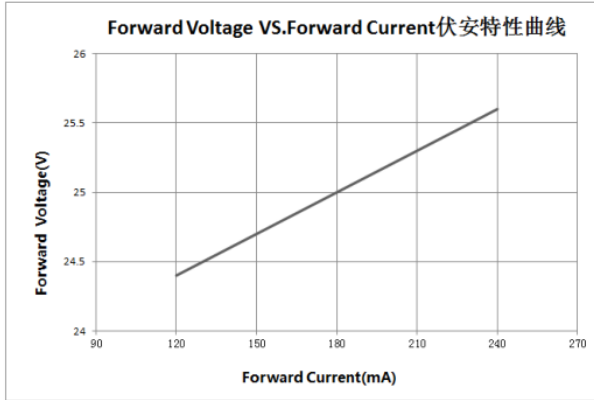

Curves of beam angel and relative brightness 角度图

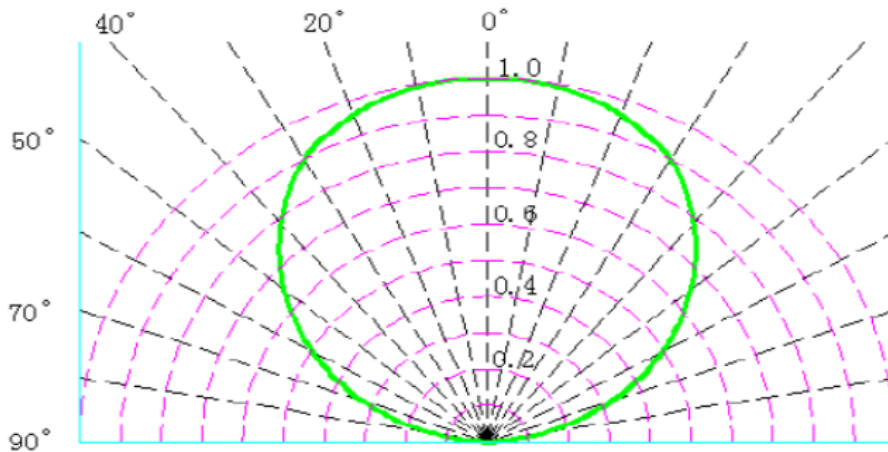

HL-EMC-5050D90W-B1C8-S1-HR3-Y

Bin Range of Chromaticity Coordinate Bin区分类及色坐标范围

CIE Chromaticity Diagram

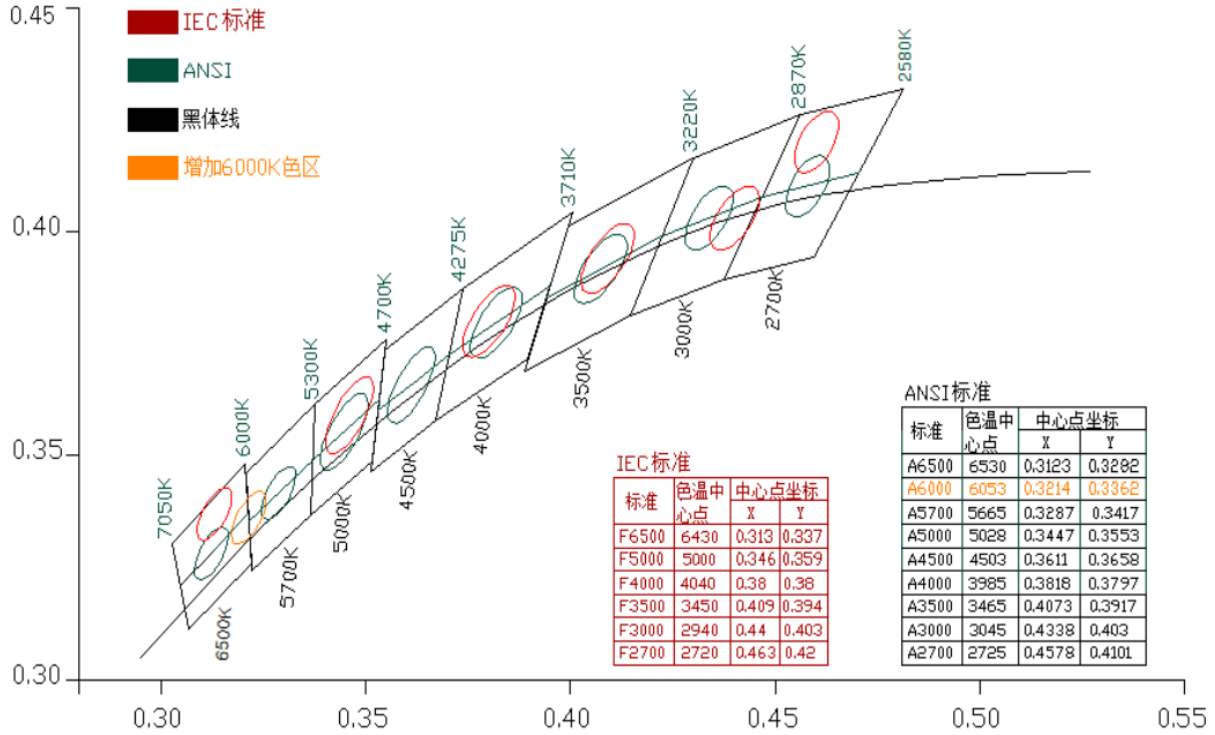

F2700 中心点	0.4630	0.4200	F3000 中心点	0.4400	0.4030	F3500 中心点	0.4090	0.3940
F4000 中心点	0.3800	0.3800	F5000 中心点	0.3460	0.3590	F6500 中心点	0.3130	0.3370
A2700	0.4813	0.4319	A3000	0.4562	0.4260	A3500	0.4299	0.4165
	0.4562	0.4260		0.4299	0.4165		0.3996	0.4015
	0.4373	0.3893		0.4147	0.3814		0.3889	0.3690
	0.4593	0.3944		0.4373	0.3893		0.4147	0.3814
中心点	0.4578	0.4101	中心点	0.4338	0.4030	中心点	0.4073	0.3917
A4000	0.4006	0.4044	A4500	0.3736	0.3874	A5000	0.3551	0.3760
	0.3736	0.3874		0.3548	0.3736		0.3376	0.3616
	0.3670	0.3578		0.3512	0.3465		0.3366	0.3369
	0.3896	0.3716		0.3670	0.3578		0.3515	0.3487
中心点	0.3818	0.3797	中心点	0.3611	0.3658	中心点	0.3447	0.3553
A5700	0.3376	0.3616	A6000	0.3291	0.3539	A6500	0.3205	0.3481
	0.3207	0.3462		0.3294	0.3306		0.3028	0.3304
	0.3222	0.3243		0.3144	0.3187		0.3068	0.3113
	0.3366	0.3369		0.3116	0.3392		0.3221	0.3261
中心点	0.3287	0.3417	中心点	0.3214	0.3362	中心点	0.3123	0.3282

HL-EMC-5050D90W-B1C8-S1-HR3-Y

SMT Reflow Soldering Instructions SMT回流焊说明

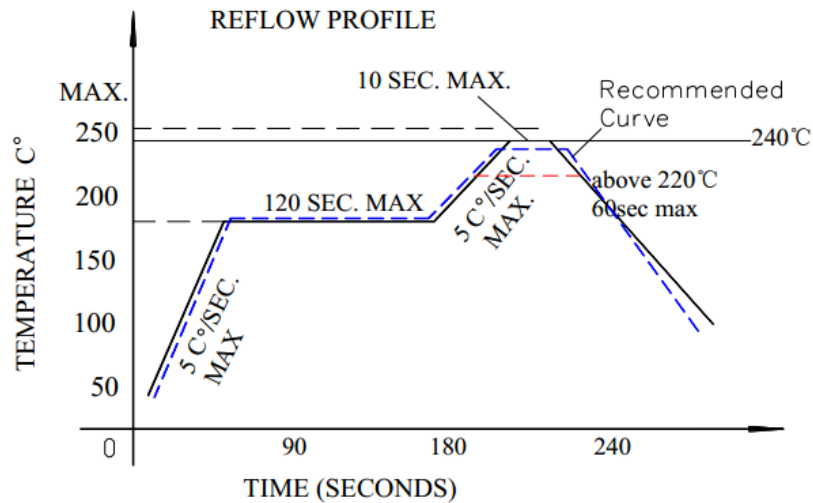

- 1.Reflow soldering should not be done more than three times. 回流焊不可以做三次以上。
- 2.When soldering , do not put stress on the LEDs during heating
当焊接时，不要在材料受热时用力压胶体表面。

Soldering iron 烙铁焊接

- 1.When hand soldering, keep the temperature of iron below less 350°C less than 5 seconds
当手工焊接时，烙铁的温度必须小于350°C，时间不可超过5秒。
- 2.The hand solder should be done only one times
手工焊接只可焊接一次。

Repairing 修补

Repair should not be done after the LEDs have been soldered. When repairing is unavoidable, a double-head soldering iron should be used (as below figure). It should be confirmed in advance whether the characteristics of LEDs will or will not be damaged by repairing.

LED回流焊后不应该修复，当修复是不可避免时，必须使用双头烙铁（如下图），但必须先确认此种方式会不会损坏LED本身的特性。

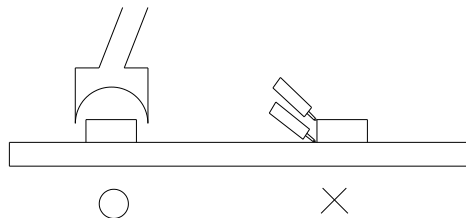

Cautions 注意事项

The encapsulated material of the LEDs is silicone. Therefore the LEDs have a soft surface on the top of package. The pressure to the top surface will be influence to the reliability of the LEDs. Precautions should be taken to avoid the strong pressure on the encapsulated part. So when use the picking up nozzle, the pressure on the silicone resin should be proper.

LED封装为硅胶，故LED胶体表面较软，用力按压胶体表面会影响LED可靠性，因此应有预防措施避免在封装的零件上的强大压力，当使用吸嘴时，胶体表面的压力应是恰当的。

HL-EMC-5050D90W-B1C8-S1-HR3-Y

Handling Precautions 处理防备措施

Compare to epoxy encapsulant that is hard and brittle, silicone is softer and flexible. Although its characteristic significantly reduces thermal stress, it is more prone to damage by external mechanical force. As a result, Special handling precautions must be observed during assembling using silicone encapsulated LED products, Failure to comply might leads to damage and premature failure of the LED.

相对环氧树脂较脆较硬而言，硅胶封装较柔软且有弹性，虽然它的特性大大减少了热应力，但易受机械外力损坏，因此在手工处理方面须要对硅胶封装材料做预防措施，若未按要求操作，可能会导致LED损坏和光衰。

1.Handle the component along the side surface by using forceps or appropriate tools; do not directly touch or Handle the silicone lens surface, it may damage the internal circuitry.

通过使用适当的工具从材料侧面夹取，不可直接用手或尖锐金属压胶体表面，它可能会损坏内部电路。

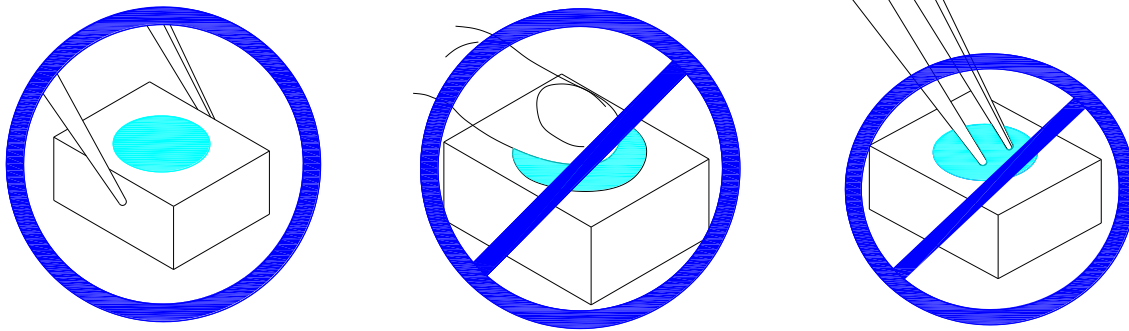

2.The outer diameter of the SMD pickup nozzle should not exceed the size of the LED to prevent air leaks. The inner diameter of the nozzle should be as large as possible. A pliable material is suggested for the nozzle tip to avoid scratching or damaging the LED surface during pickup. The dimensions of the component must be accurately programmed in the pick-and-place machine to insure precise pickup and avoid damage during production.

为防止气压泄漏，SMD吸咀外径不可以超过LED尺寸，吸咀内径尺寸应尽可能大，吸咀顶端材质建议采用柔软材料以防在吸取期间刮伤或损坏LED胶体表面，元件的尺寸必须在取放机里准确的编程好，以确保精确的吸取和避免生产过程中的损害。



3.Do not stack together assembled PCBs containing LEDs. Impact may scratch the silicone lens or damage the internal circuitry

不可将模组材料堆积在一起，它可能会损坏内部电路。

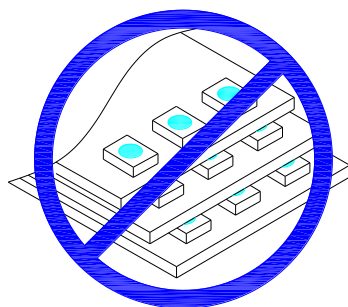

4.Not suitable to operate in acidic environment, PH<7

不可用在PH<7的酸性场所。



5.LED operating environment and sulfur element composition cannot be over 100PPM in the LED mating usage material.

LED工作环境及与LED适配的材料中硫元素及化合物成份不可超过100PPM。

6.When we need to use external glue for LED application products, please make sure that the external glue matches the LED packaging glue. Additionally ,as most of LED packaging glue is silica gel, and it has strong Oxygen permeability as well as strong moisture permeability; in order to prevent external material from getting into the inside of LED, which may cause the malfunction of LED, the single content of Bromine element is required to be less than 900PPM,the single content of Chlorine element is required to be less than 900PPM,the total content of Bromine element and Chlorine element in the external glue of the application products is required to be less than 1500PPM

当我们需要使用外封胶涂抹LED产品时，应确保外封胶与LED封装胶水相匹配，因为大多数LED的封装胶水为硅胶，它有较强的氧化性和较强的吸湿性，必须防止外封材质进入LED内部以造成LED的损伤，单一的溴元素含量要求小于900PPM，单一氯元素含量要求小于900PPM，在涂抹LED产品时要求外封胶溴元素与氯元素总含量必须小于1500PPM。

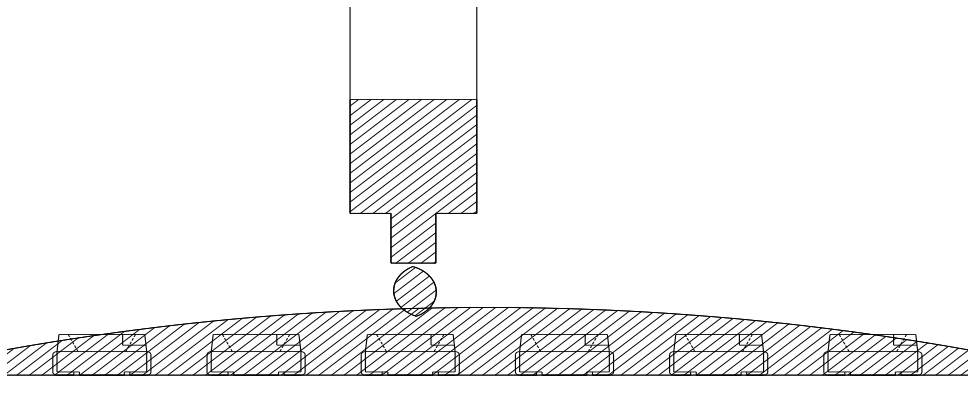

7.Other points for attention, please refer to our LED user manual , In accordance with the user manual, the product shelf life is 24 months , If there is a warranty agreement, the warranty agreement shall prevail

其它注意事项请参照我们的LED使用手册，符合使用手册的情况下，产品保质期为24个月，已签订保质协议的则以保质协议为准

HL-EMC-5050D90W-B1C8-S1-HR3-Y

Label 标签

PartNo: Part number 型号
 ΦV: Luminous intensity rank 亮度等级
 VF: Forward voltage rank 电压等级
 X/Y: Coordinate rank 色坐标
 TC: Color temperature 色温
 LotNo: Lot number 批号
 LotNo: Lot number 工单号



PartNo: VF: XY:

ΦV: TC: 

Qty: LotNo:



Packaging Specification 包装规格

Package: 2000pcs/reel. 包装每卷 2000pcs。

1 Carrier Tape Dimension 载带尺寸

Feeding Direction 

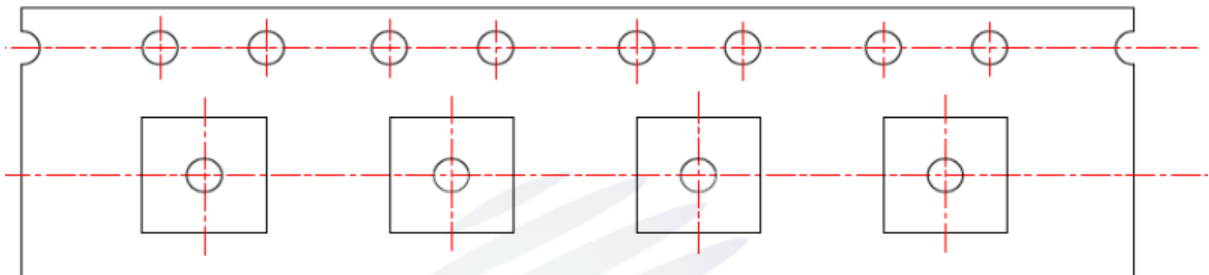

2.1.2 Reel Dimension 卷盘尺寸

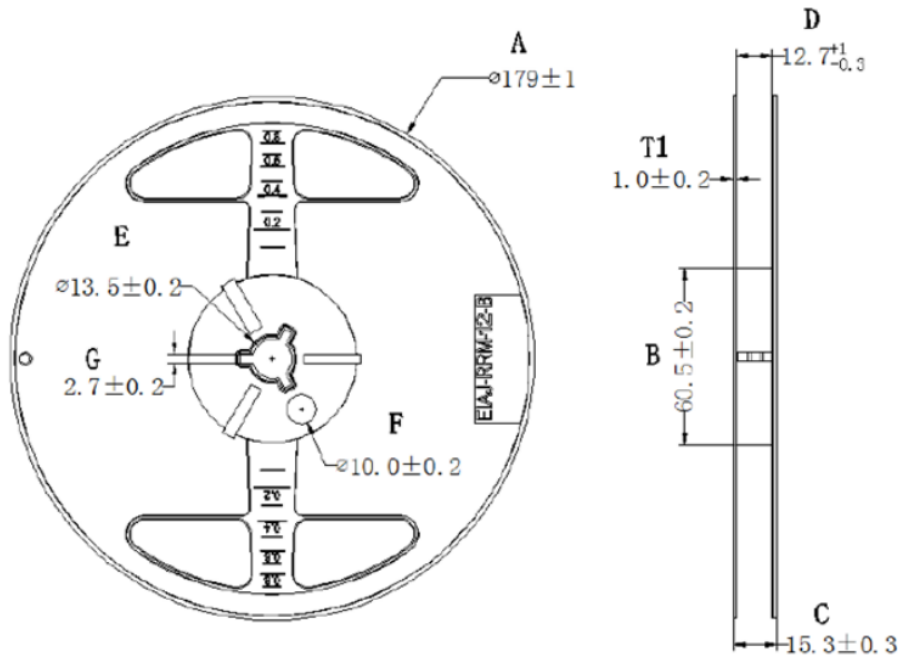

Note: The tolerances unless mentioned is $\pm 0.1\text{mm}$, Unit: mm 注: 标注公差为 $\pm 0.1\text{mm}$, 单位: mm

修订次数	修订人	修订内容	修订日期	版次
1	陈少霞	新建文件	2022/06/01	A/0
2				
3				
4				
5				
6				
7				
8				
9				
10				
11				
12				
13				
14				
15				
16				
17				
18				
19				
20				
21				
22				
23				
24				