

To all our customers

---

## **Regarding the change of names mentioned in the document, such as Hitachi Electric and Hitachi XX, to Renesas Technology Corp.**

---

The semiconductor operations of Mitsubishi Electric and Hitachi were transferred to Renesas Technology Corporation on April 1st 2003. These operations include microcomputer, logic, analog and discrete devices, and memory chips other than DRAMs (flash memory, SRAMs etc.) Accordingly, although Hitachi, Hitachi, Ltd., Hitachi Semiconductors, and other Hitachi brand names are mentioned in the document, these names have in fact all been changed to Renesas Technology Corp. Thank you for your understanding. Except for our corporate trademark, logo and corporate statement, no changes whatsoever have been made to the contents of the document, and these changes do not constitute any alteration to the contents of the document itself.

Renesas Technology Home Page: <http://www.renesas.com>

Renesas Technology Corp.  
Customer Support Dept.  
April 1, 2003

## Cautions

Keep safety first in your circuit designs!

1. Renesas Technology Corporation puts the maximum effort into making semiconductor products better and more reliable, but there is always the possibility that trouble may occur with them. Trouble with semiconductors may lead to personal injury, fire or property damage.

Remember to give due consideration to safety when making your circuit designs, with appropriate measures such as (i) placement of substitutive, auxiliary circuits, (ii) use of nonflammable material or (iii) prevention against any malfunction or mishap.

Notes regarding these materials

1. These materials are intended as a reference to assist our customers in the selection of the Renesas Technology Corporation product best suited to the customer's application; they do not convey any license under any intellectual property rights, or any other rights, belonging to Renesas Technology Corporation or a third party.
2. Renesas Technology Corporation assumes no responsibility for any damage, or infringement of any third-party's rights, originating in the use of any product data, diagrams, charts, programs, algorithms, or circuit application examples contained in these materials.
3. All information contained in these materials, including product data, diagrams, charts, programs and algorithms represents information on products at the time of publication of these materials, and are subject to change by Renesas Technology Corporation without notice due to product improvements or other reasons. It is therefore recommended that customers contact Renesas Technology Corporation or an authorized Renesas Technology Corporation product distributor for the latest product information before purchasing a product listed herein.  
The information described here may contain technical inaccuracies or typographical errors. Renesas Technology Corporation assumes no responsibility for any damage, liability, or other loss rising from these inaccuracies or errors.  
Please also pay attention to information published by Renesas Technology Corporation by various means, including the Renesas Technology Corporation Semiconductor home page (<http://www.renesas.com>).
4. When using any or all of the information contained in these materials, including product data, diagrams, charts, programs, and algorithms, please be sure to evaluate all information as a total system before making a final decision on the applicability of the information and products. Renesas Technology Corporation assumes no responsibility for any damage, liability or other loss resulting from the information contained herein.
5. Renesas Technology Corporation semiconductors are not designed or manufactured for use in a device or system that is used under circumstances in which human life is potentially at stake. Please contact Renesas Technology Corporation or an authorized Renesas Technology Corporation product distributor when considering the use of a product contained herein for any specific purposes, such as apparatus or systems for transportation, vehicular, medical, aerospace, nuclear, or undersea repeater use.
6. The prior written approval of Renesas Technology Corporation is necessary to reprint or reproduce in whole or in part these materials.
7. If these products or technologies are subject to the Japanese export control restrictions, they must be exported under a license from the Japanese government and cannot be imported into a country other than the approved destination.  
Any diversion or reexport contrary to the export control laws and regulations of Japan and/or the country of destination is prohibited.
8. Please contact Renesas Technology Corporation for further details on these materials or the products contained therein.

---

# HA13164A

## Multiple Voltage Regulator



ADE-207-342 (Z)

Rev.0  
Jun. 2001

---

### General Description

The HA13164A is a compact multiple voltage regulator for car audio system. The outputs of this IC output consist of regulated 5.7 V output for a microcontroller, regulated 8 V output for CD driver, regulated 9.0 V output for audio control, regulated 10 V output for illuminations and regulated 5 V output, VCC-dependent output for external output and VCC-dependent output for remote-ANT.

### Functions

#### General

- ACC power monitor circuit is built-in as to detect low voltage.
- Low saturation output (PNP output) used for audio output.
- Adjustable voltage for illumination output by changing an external resistor.

#### Protections

- Output current limit circuit to avoid device destruction caused by shorted output, etc.
- High surge input protector against VCC and ACC.
- Built in a thermal shutdown circuit to prevent against the thermal destruction.

## Pin Description and Equivalent Circuit

Pin No.	Pin Name	Specification	Equivalent Circuit	Function		
				Normal Operation	TSD	Surge Input
1	EXT OUT	VCC-1V/300mA min		Output voltage is VCC-1 V when M or H level applied to CTRL pin.	0V	0V
2	ANT OUT	VCC-1V/300mA min		Output voltage is VCC-1 V when M or H level to CTRL pin and H level to ANT-CTRL.	0V	0V
3	ACCIN	—		Connected to ACC.	—	—
4	VDD OUT	5.7V/100mA min		Regular 5.7V.	5.7V	0V
5	SW5VOUT	5.0V/100mA min		Output voltage is 5V when M or H level applied to CTRL pin.	0V	0V
6	COMPOUT	5.0V/100mA min		Output for ACC detector	0V	0V
7	ANT CTRL	—		L: ANT output OFF H: ANT output ON	—	—

Pin Description and Equivalent Circuit (cont)

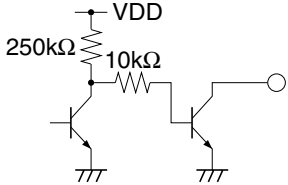
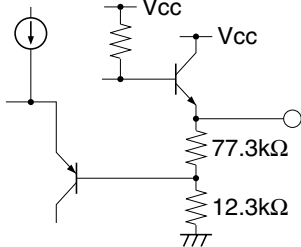
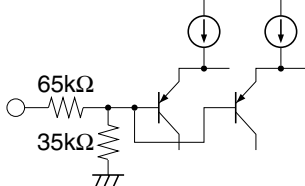
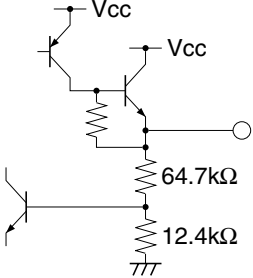
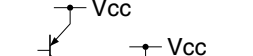
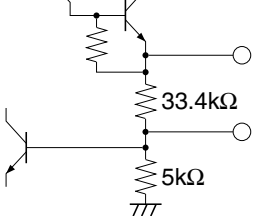
Pin No.	Pin Name	Specification	Equivalent Circuit	Function		
				Normal Operation	TSD	Surge Input
8	VCC	—		Connected to VCC	—	—
9	BATT DET	—		Low battery detect.	Detect	Not detect
10	AUDIOOUT	9.0V/500mA min		Output voltage is 9V when M or H level applied to CTRL pin.	0V	0V
11	CTRL	—		L: BIAS OFF M: BIAS ON H: CD ON	—	—
12	CD OUT	8.0V/1.3A min		Output voltage is 8V when H level applied to CTRL pin.	0V	0V
13	ILM AJ	—		Adjustment pin for ILM output voltage.	—	—
14	ILM OUT	9.85V/500mA min		Output voltage is 10V when M or H level applied to CTRL pin	0V	0V
15	GND	—		Connected to GND	—	—

## Timing Chart

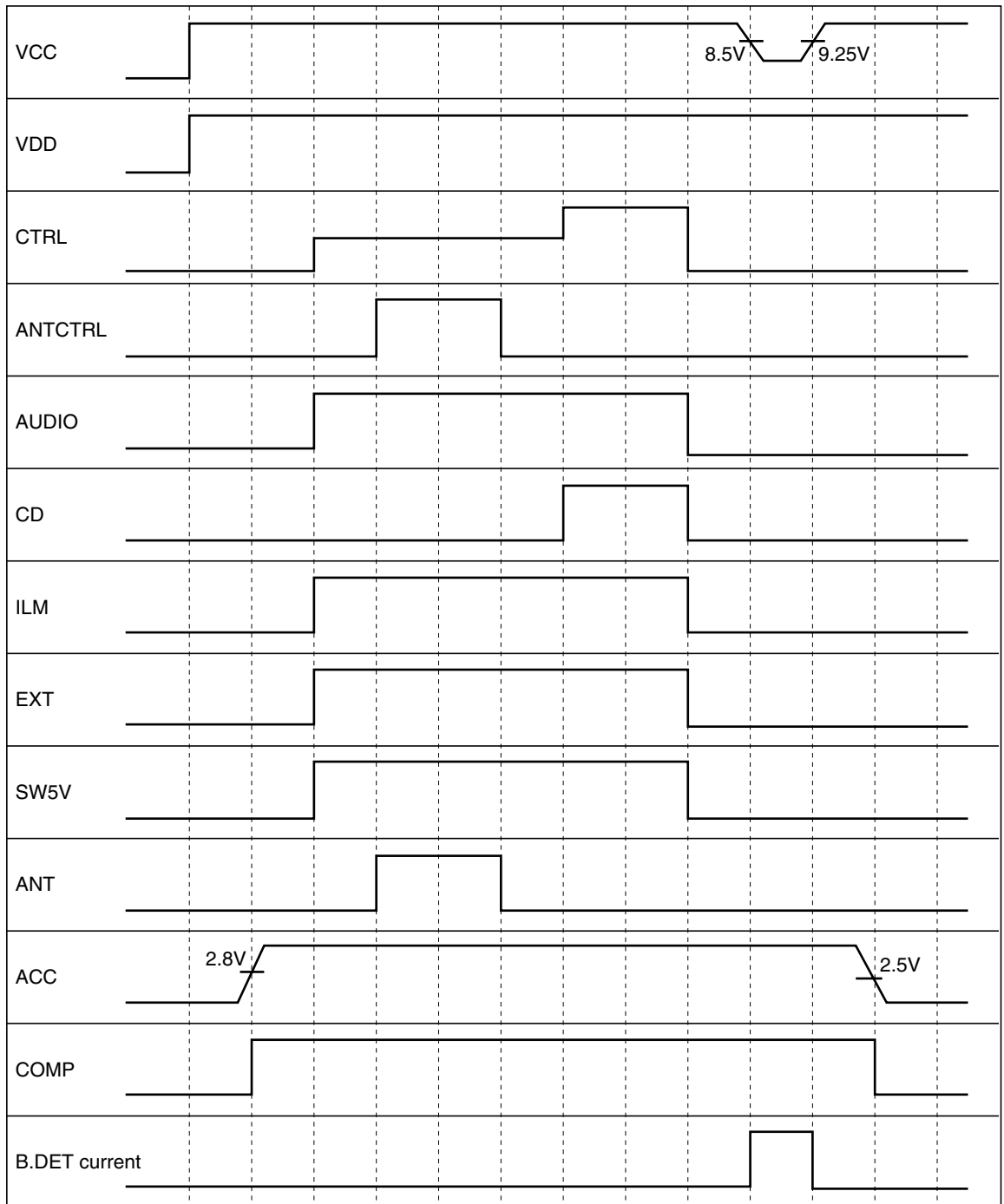

Block Diagram

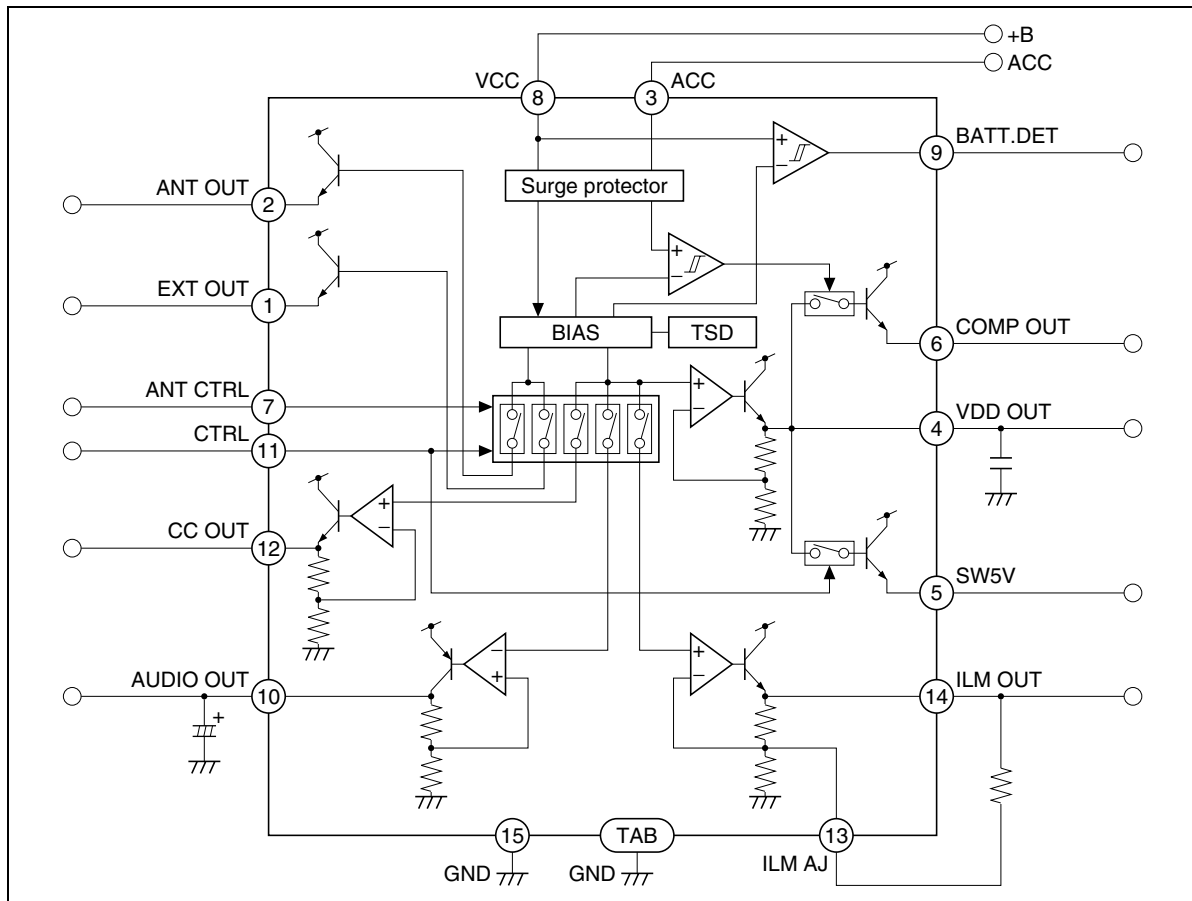

## Absolute Maximum Ratings

(Ta = 25°C)

Item	Symbol	Value	Unit	Note
Operating power supply voltage	Vcc	18	V	
DC supply voltage	Vcc(DC)	26	V	1
Peak voltage	Vcc(PEAK)	50	V	2
Power dissipation	Pd	36	W	3
Junction temperature	Tj	150	°C	
Operating temperature	Topr	-40 to +85	°C	
Storage temperature	Tstg	-55 to +125	°C	

Notes: Recommended power supply voltage range 10V to 16V.

1. Applied time is less than 30 sec.
2. Surge pulse as input.
3. Ta=25°C. :Permissible power dissipation when using a heat sink of infinite area. Refer to the derating curves below.

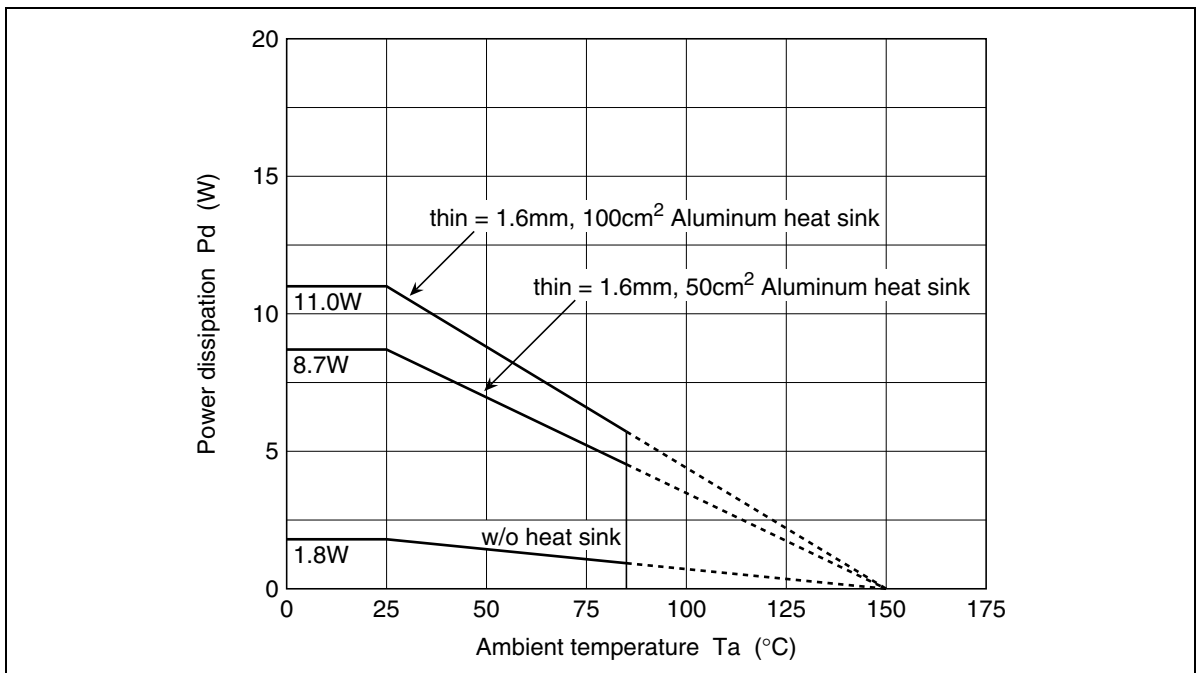



## Electrical Characteristics

(unless otherwise noted,  $V_{CC} = 13.2\text{ V}$ ,  $T_a = 25^\circ\text{C}$ )

Item	Symbol	Min	Typ	Max	Unit	Test Condition	
Standby current	IST	—	460	700	$\mu\text{A}$	ACC = 0V, CTRL = 0V	
CTRL L level (STBY mode)	VCL	0	—	1.0	V		
CTRL M level (CD OFF mode)	VCM	2.0	—	3.0	V		
CTRL H level (CD ON mode)	VCH	4.0	—	—	V		
ANT CTRL L level (ANTOFF mode)	VACL	0	—	2.0	V		
ANT CTRL H level (ANT ON mode)	VACH	3.0	—	—	V		
VDD OUT	Output voltage	Vo1	5.4	5.7	6.0	V	Io1 = 80mA
	Voltage regulation	$\Delta\text{Vo}11$	—	10	50	mV	$V_{CC} = 10$ to 16V, Io1 = 80mA
	Load regulation	$\Delta\text{Vo}12$	—	50	100	mV	Io1 = 0 to 80mA
	Minimum I/O voltage differential	$\Delta\text{Vo}13$	—	1.0	1.5	V	Io1 = 80mA
	Output current capacity	Io1	100	250	—	mA	Vo1 $\geq$ 5.4V
	Ripple rejection ratio	SVR1	50	60	—	dB	f = 100Hz, Io1 = 80mA
CD OUT	Output voltage 2	Vo2	7.6	8.0	8.4	V	Io2 = 1.0A
	Voltage regulation	$\Delta\text{Vo}21$	—	40	100	mV	$V_{CC} = 10$ to 16V, Io2 = 1.0A
	Load regulation	$\Delta\text{Vo}22$	—	70	150	mV	Io2 = 10m to 1.0A
	Minimum I/O voltage differential	$\Delta\text{Vo}23$	—	1.0	1.5	V	Io2 = 1.0A
	Output current capacity	Io2	1.3	2.0	—	A	Vo2 $\geq$ 7.6V
Ripple rejection ratio	SVR2	40	45	—	dB	f = 100Hz, Io2 = 1.0A	
AUDIO OUT	Output voltage 3	Vo3	8.5	9.0	9.5	V	Io3 = 400mA
	Voltage regulation	$\Delta\text{Vo}31$	—	30	90	mV	$V_{CC} = 10$ to 16V, Io3 = 400mA
	Load regulation	$\Delta\text{Vo}32$	—	100	200	mV	Io3 = 10 to 400mA
	Minimum I/O voltage differential	$\Delta\text{Vo}33$	—	0.4	0.9	V	Io3 = 400mA
	Output current capacity	Io3	500	850	—	mA	Vo3 $\geq$ 8.5V
Ripple rejection ratio	SVR3	45	50	—	dB	f = 100Hz, Io3 = 400mA	
ILM OUT	Output voltage 4	Vo4	9.35	9.85	10.35	V	Io4 = 400mA
	Voltage regulation	$\Delta\text{Vo}41$	—	40	100	mV	$V_{CC} = 12.5$ to 16V, Io4 = 400mA
	Load regulation	$\Delta\text{Vo}42$	—	50	100	mV	Io4 = 10 to 400mA
	Minimum I/O voltage differential	$\Delta\text{Vo}43$	—	1.0	1.5	V	Io4 = 400mA
	Output current capacity	Io4	500	900	—	mA	Vo4 $\geq$ 9.35V
Ripple rejection ratio	SVR4	35	40	—	dB	f = 100Hz, Io4 = 400mA	
EXT12 OUT	Differential I/O voltage	$\Delta\text{Vo}51$	—	1.0	1.5	V	Io5 = 300mA
	Load regulation	$\Delta\text{Vo}52$	—	350	600	mV	Io5 = 10 to 300mA
	Output current capacity	Io5	300	500	—	mA	Vo5 $\geq$ 11.7V

## Electrical Characteristics (cont)

(unless otherwise noted,  $V_{CC} = 13.2\text{ V}$ ,  $T_a = 25^\circ\text{C}$ )

Item		Symbol	Min	Typ	Max	Unit	Test Condition
ANT OUT	Differential I/O voltage	$\Delta V_{o61}$	—	1.0	1.5	V	$I_{o6} = 300\text{mA}$
	Load regulation	$\Delta V_{o62}$	—	350	600	mV	$I_{o6} = 10\text{ to }300\text{mA}$
	Output current capacity	$I_{o6}$	300	500	—	mA	$V_{o6} \geq 11.7\text{V}$
SW5V OUT	Output voltage	$V_{o7}$	4.6	5.0	5.4	V	$I_{o7} = 80\text{mA}$ , $V_{DD} = \text{no load}$
	Output current capacity	$I_{o7}$	100	300	—	mA	$V_{o7} \geq 4.6\text{V}$
ACC OUT	Output voltage	$V_{o8}$	4.6	5.0	5.4	V	$I_{o8} = 40\text{mA}$ , $V_{DD} = \text{no load}$
	Output current capacity	$I_{o8}$	100	300	—	mA	$V_{o8} \geq 4.6\text{V}$
	Rise threshold voltage	$V_{THH8}$	2.6	2.8	3.0	V	
	Hysteresis range	$\Delta V_{TH8}$	0.2	0.3	0.4	V	
BATT. DET	Threshold voltage	$V_{THH9}$	8.1	8.5	8.9	V	
	Hysteresis range	$\Delta V_{TH9}$	0.55	0.75	0.95	V	
	Output current capacity	$I_{o9}$	200	—	—	$\mu\text{A}$	$V_{o9} = 0.3\text{V}$

Evaluation Circuit

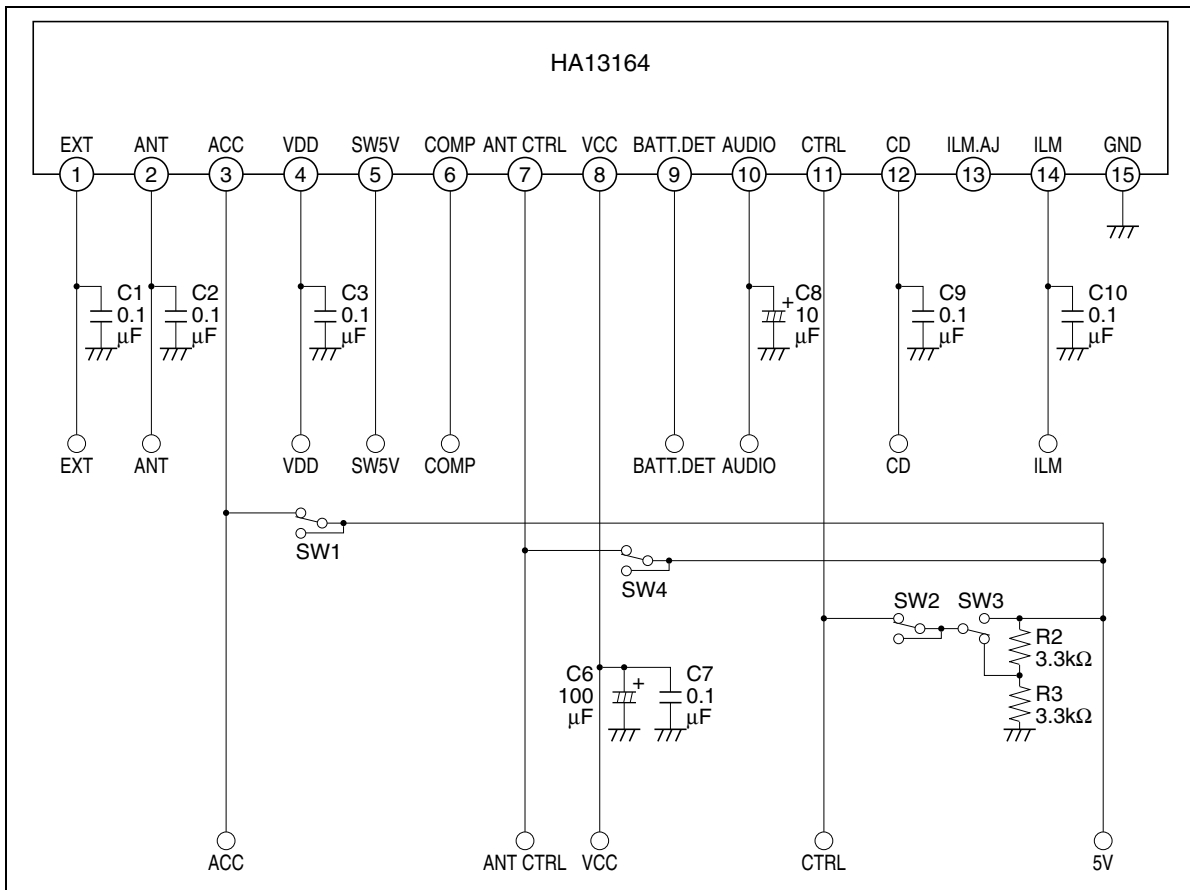

## Main Characteristic

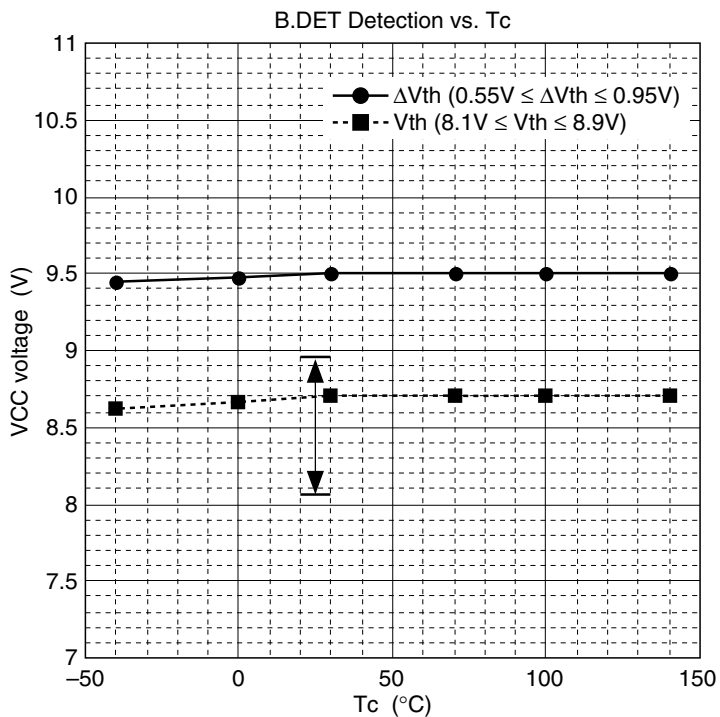
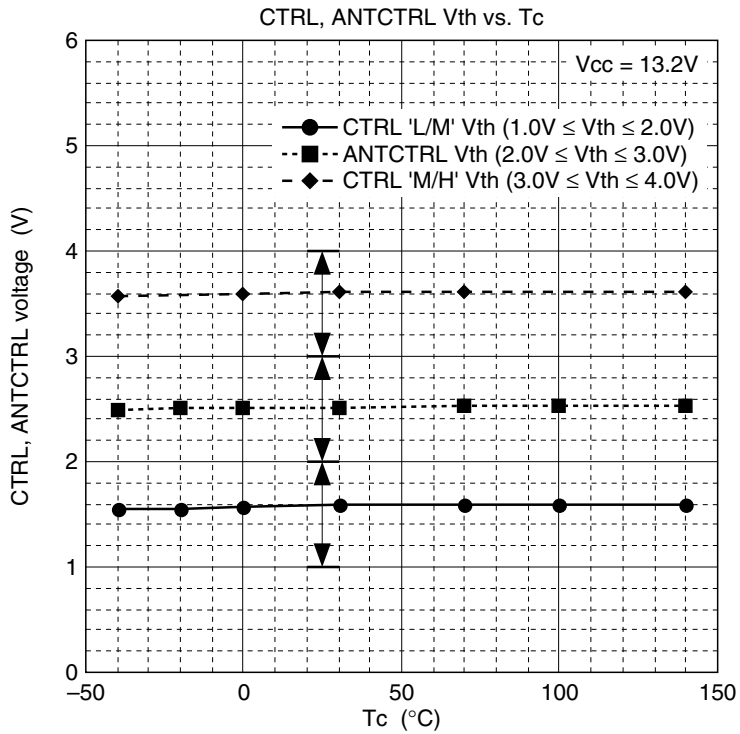

ACC Detection vs. Tc

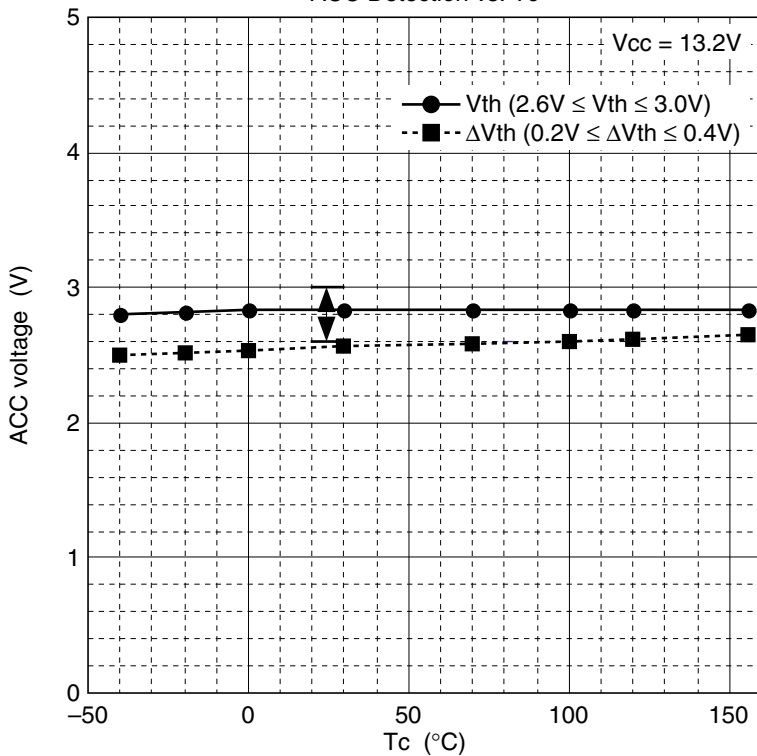

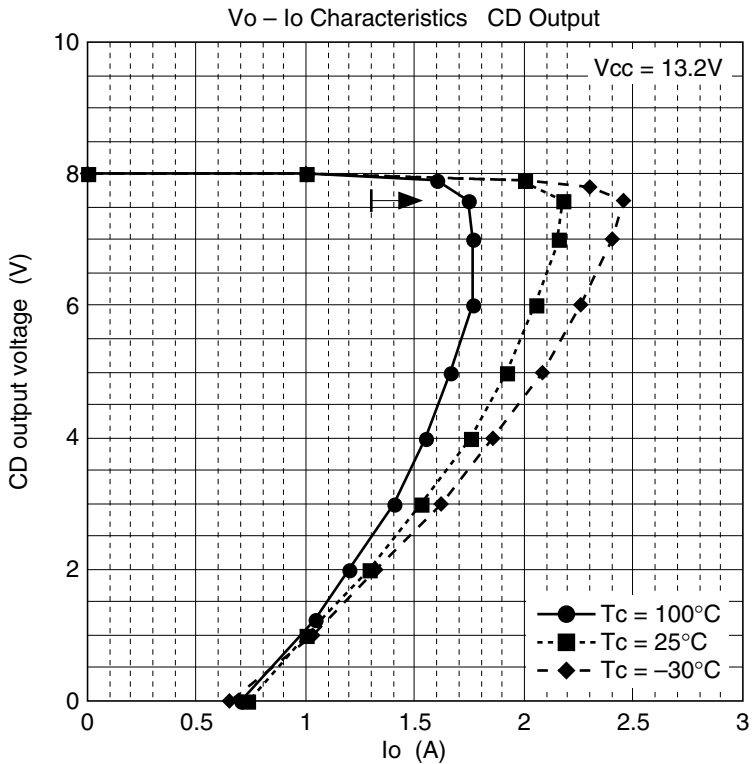
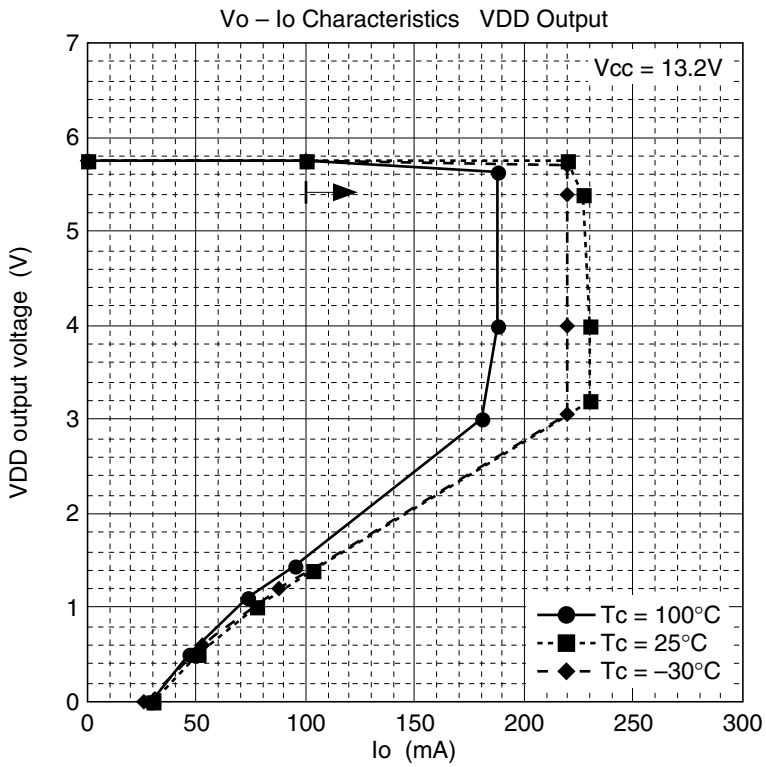

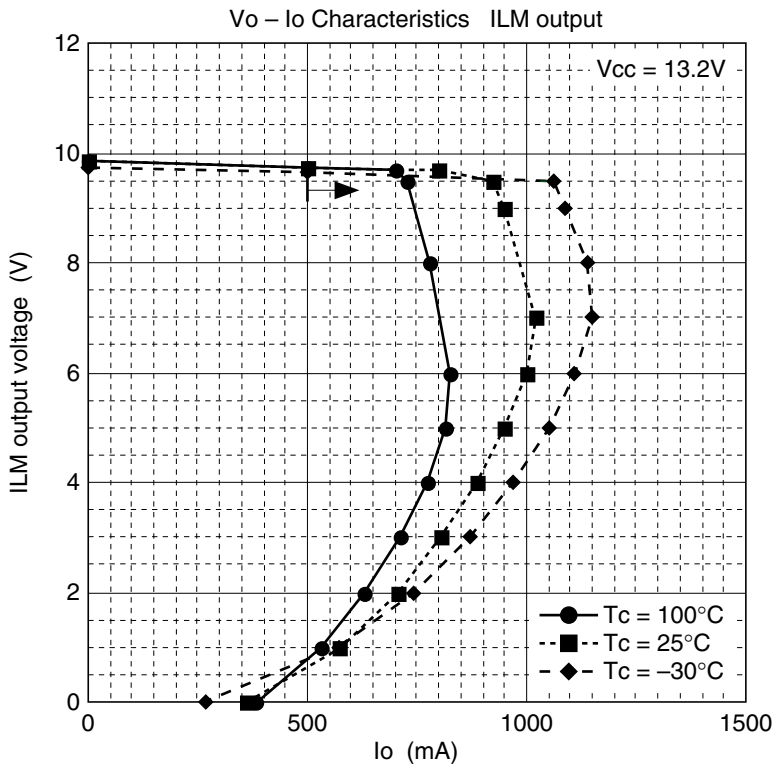
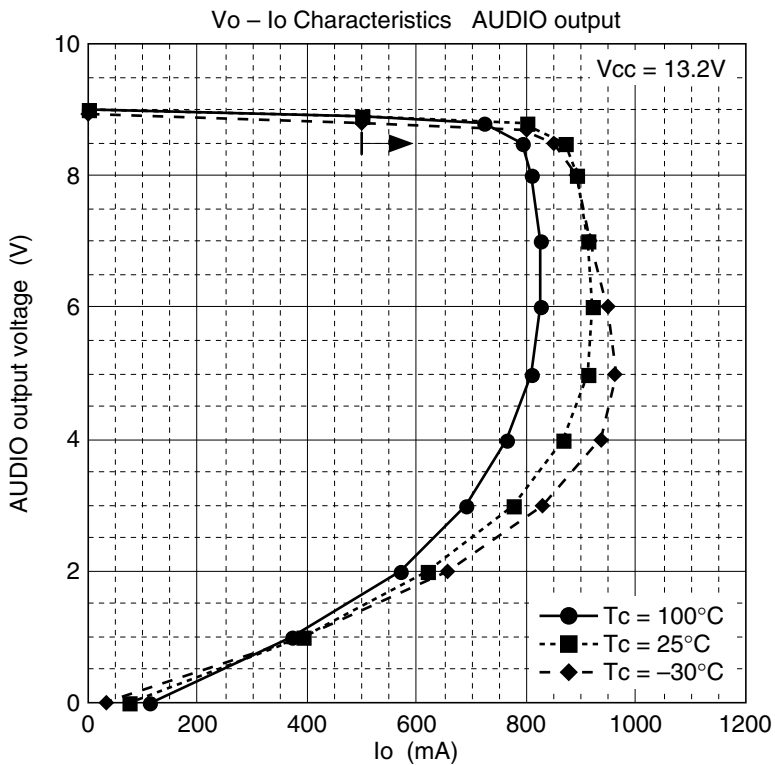

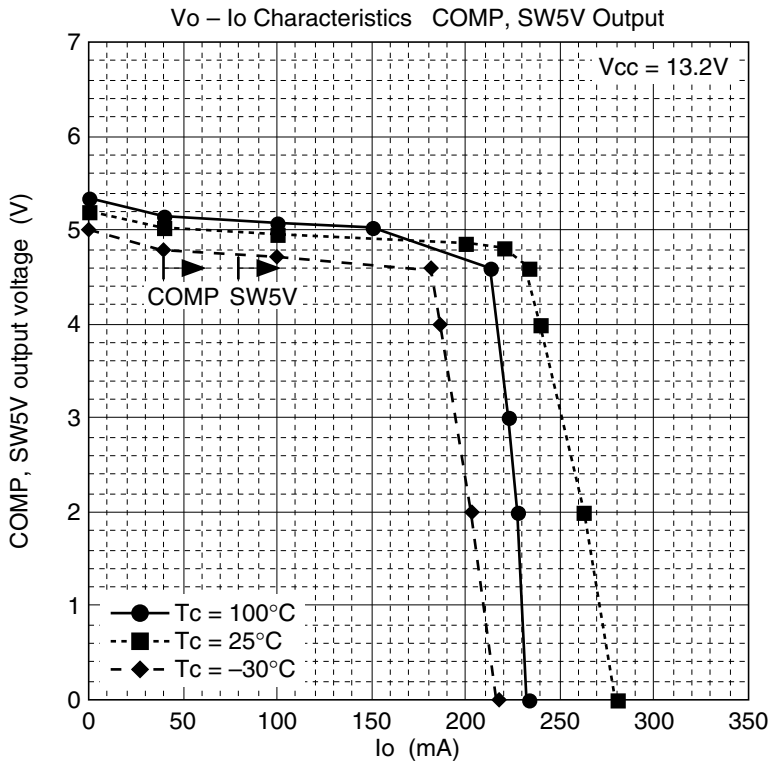
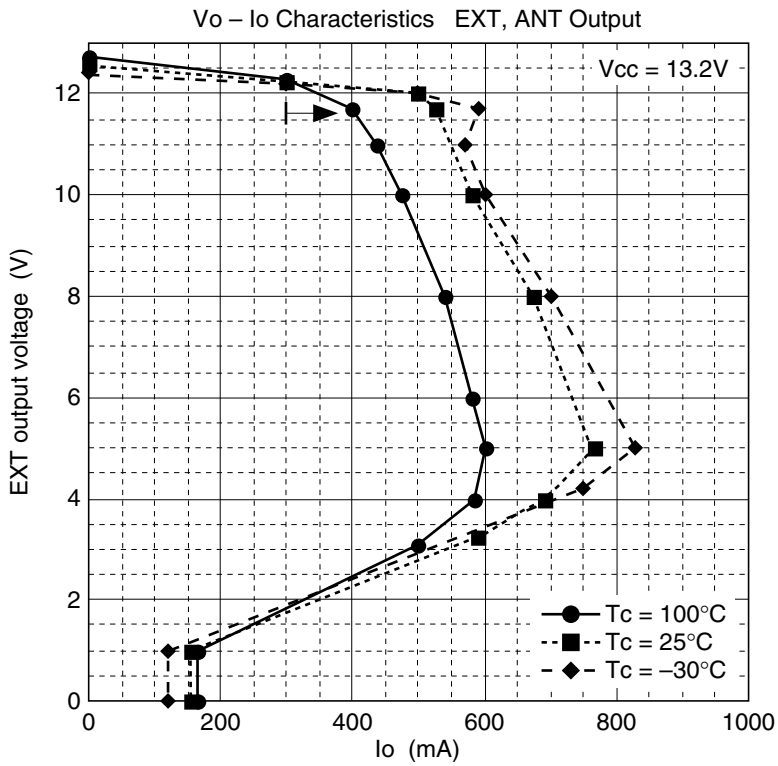



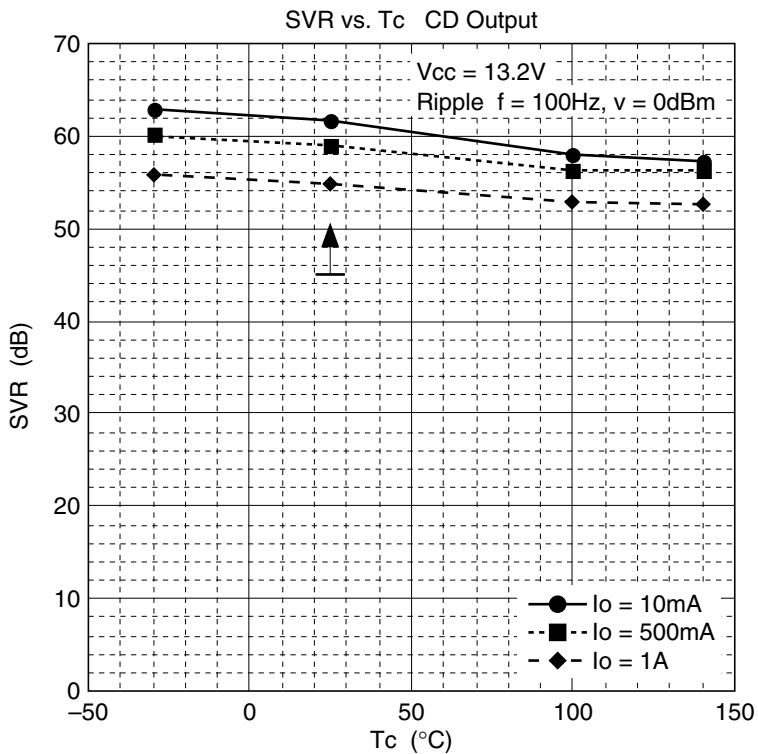
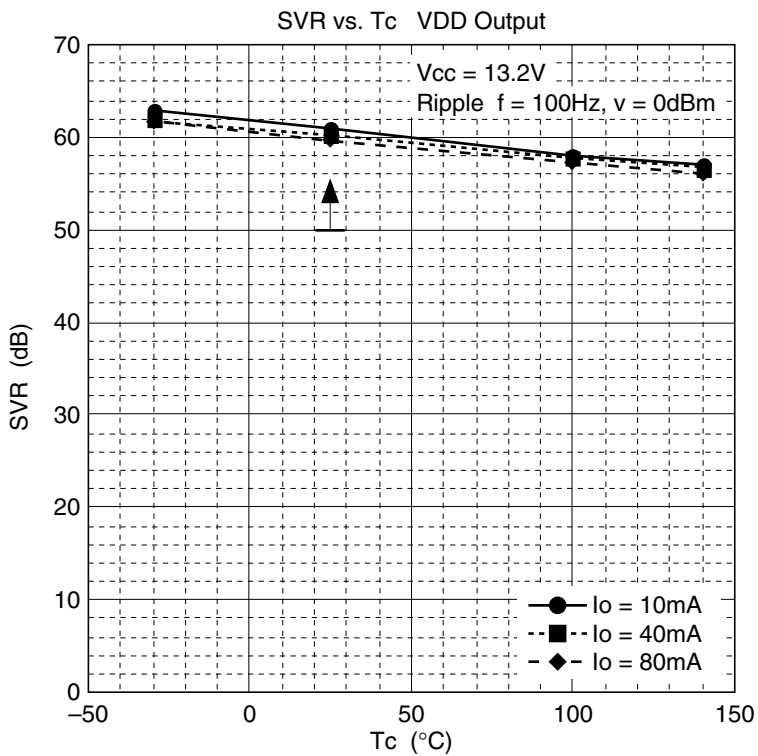

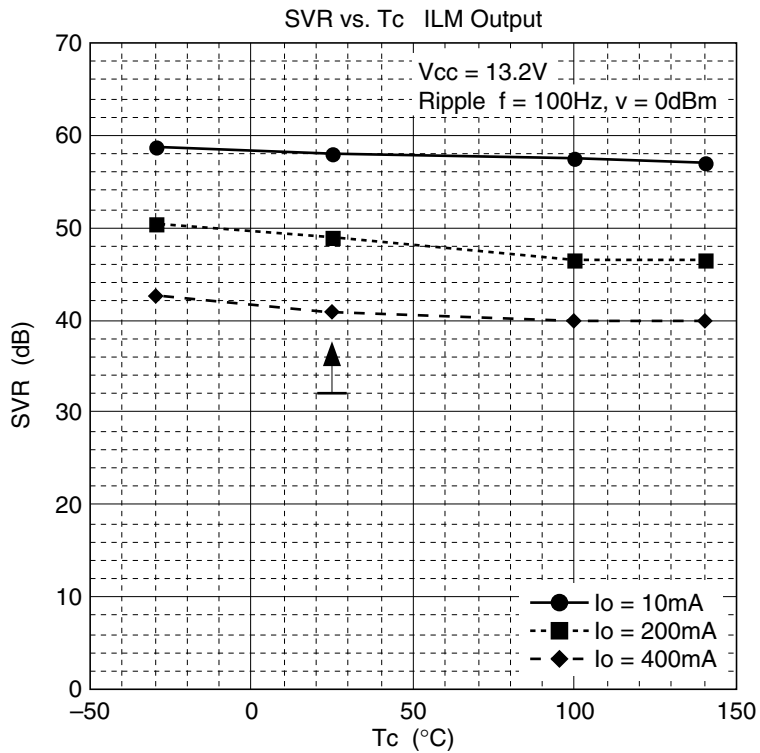
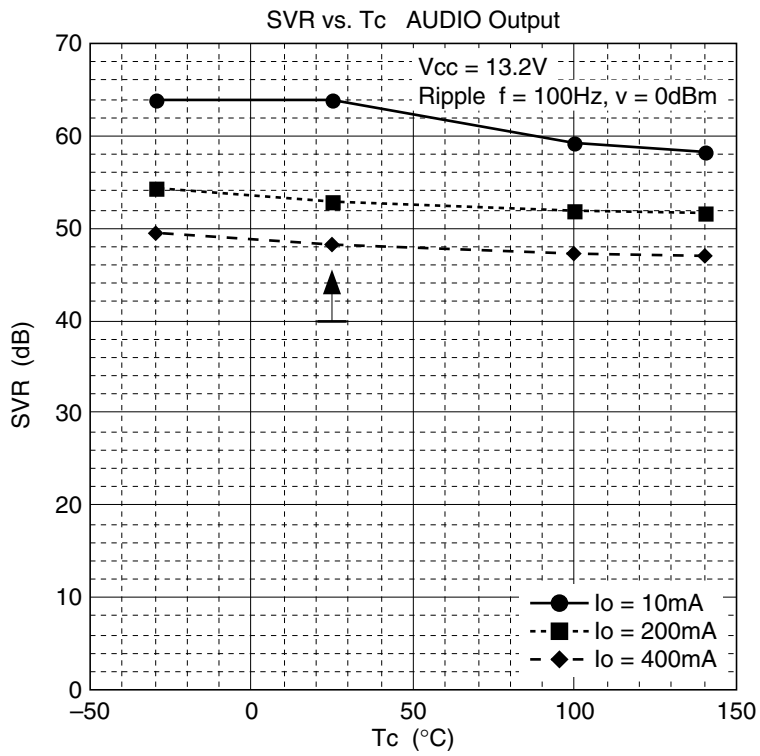

Package Dimensions

Unit: mm

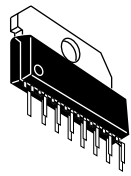
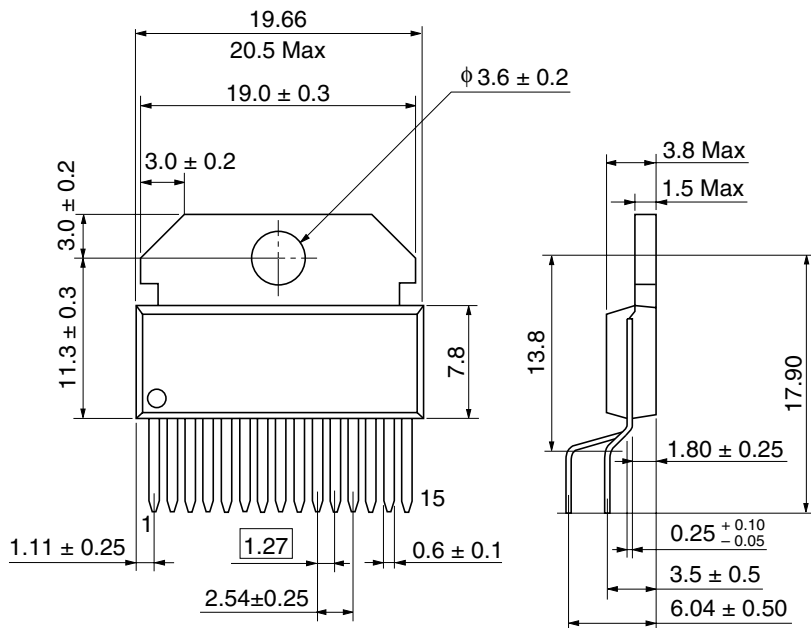

Hitachi Code	SP-15TF
JEDEC	—
JEITA	—
Weight (reference value)	3.10 g

## Disclaimer

1. Hitachi neither warrants nor grants licenses of any rights of Hitachi's or any third party's patent, copyright, trademark, or other intellectual property rights for information contained in this document. Hitachi bears no responsibility for problems that may arise with third party's rights, including intellectual property rights, in connection with use of the information contained in this document.
2. Products and product specifications may be subject to change without notice. Confirm that you have received the latest product standards or specifications before final design, purchase or use.
3. Hitachi makes every attempt to ensure that its products are of high quality and reliability. However, contact Hitachi's sales office before using the product in an application that demands especially high quality and reliability or where its failure or malfunction may directly threaten human life or cause risk of bodily injury, such as aerospace, aeronautics, nuclear power, combustion control, transportation, traffic, safety equipment or medical equipment for life support.
4. Design your application so that the product is used within the ranges guaranteed by Hitachi particularly for maximum rating, operating supply voltage range, heat radiation characteristics, installation conditions and other characteristics. Hitachi bears no responsibility for failure or damage when used beyond the guaranteed ranges. Even within the guaranteed ranges, consider normally foreseeable failure rates or failure modes in semiconductor devices and employ systemic measures such as fail-safes, so that the equipment incorporating Hitachi product does not cause bodily injury, fire or other consequential damage due to operation of the Hitachi product.
5. This product is not designed to be radiation resistant.
6. No one is permitted to reproduce or duplicate, in any form, the whole or part of this document without written approval from Hitachi.
7. Contact Hitachi's sales office for any questions regarding this document or Hitachi semiconductor products.

## Sales Offices

# HITACHI

### Hitachi, Ltd.

Semiconductor & Integrated Circuits  
Nippon Bldg., 2-6-2, Ohte-machi, Chiyoda-ku, Tokyo 100-0004, Japan  
Tel: (03) 3270-2111 Fax: (03) 3270-5109

URL <http://www.hitachisemiconductor.com/>

### For further information write to:

Hitachi Semiconductor  
(America) Inc.  
179 East Tasman Drive  
San Jose, CA 95134  
Tel: <1> (408) 433-1990  
Fax: <1> (408) 433-0223

Hitachi Europe Ltd.  
Electronic Components Group  
Whitebrook Park  
Lower Cookham Road  
Maidenhead  
Berkshire SL6 8YA, United Kingdom  
Tel: <44> (1628) 585000  
Fax: <44> (1628) 585200

Hitachi Europe GmbH  
Electronic Components Group  
Dornacher Straße 3  
D-85622 Feldkirchen  
Postfach 201, D-85619 Feldkirchen  
Germany  
Tel: <49> (89) 9 9180-0  
Fax: <49> (89) 9 29 30 00

Hitachi Asia Ltd.  
Hitachi Tower  
16 Collyer Quay #20-00  
Singapore 049318  
Tel: <65>-6538-6533/6538-8577  
Fax: <65>-6538-6933/6538-3877  
URL: <http://semiconductor.hitachi.com.sg>

Hitachi Asia Ltd.  
(Taipei Branch Office)  
4/F, No. 167, Tun Hwa North Road  
Hung-Kuo Building  
Taipei (105), Taiwan  
Tel: <886>-(2)-2718-3666  
Fax: <886>-(2)-2718-8180  
Telex: 23222 HAS-TP  
URL: <http://www.hitachi.com.tw>

Hitachi Asia (Hong Kong) Ltd.  
Group III (Electronic Components)  
7/F., North Tower  
World Finance Centre,  
Harbour City, Canton Road  
Tsim Sha Tsui, Kowloon Hong Kong  
Tel: <852>-2735-9218  
Fax: <852>-2730-0281  
URL: <http://semiconductor.hitachi.com.hk>

Copyright © Hitachi, Ltd., 2002. All rights reserved. Printed in Japan.

Colophon 6.0

This datasheet has been download from:

[www.datasheetcatalog.com](http://www.datasheetcatalog.com)

Datasheets for electronics components.