

## High voltage power Schottky rectifier

### Features

- Negligible switching losses
- High junction temperature capability
- Low leakage current
- Good trade-off between leakage current and forward voltage drop
- Avalanche capability specified
- ECOPACK2<sup>®</sup> halogen-free component (SMAflat)

### Description

Schottky rectifiers designed for high frequency miniature switched mode power supplies such as adaptators and on board DC/DC converters.

Packaged in SMA, SMAflat or SMB.

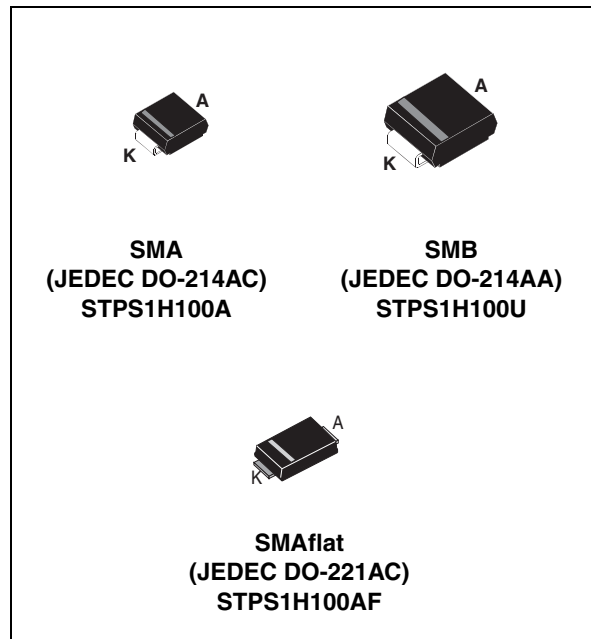

**Table 1. Device summary**

$I_{F(AV)}$	1 A
$V_{RRM}$	100 V
$T_j(max)$	175 °C
$V_F(max)$	0.62 V

# 1 Characteristics

**Table 2. Absolute ratings (limiting values)**

Symbol	Parameter	Value	Unit
V <sub>RRM</sub>	Repetitive peak reverse voltage	100	V
I <sub>F(RMS)</sub>	RMS forward voltage	10	A
I <sub>F(AV)</sub>	Average forward current	T <sub>L</sub> = 160 °C δ = 0.5	A
I <sub>FSM</sub>	Surge non repetitive forward current	t <sub>p</sub> = 10 ms sinusoidal	A
I <sub>RRM</sub>	Repetitive peak reverse current	t <sub>p</sub> = 2 μs F = 1 kHz square	A
I <sub>RSM</sub>	Non repetitive peak reverse current	t <sub>p</sub> = 100 μs square	A
P <sub>ARM</sub>	Repetitive peak avalanche power	t <sub>p</sub> = 1 μs T <sub>j</sub> = 25 °C	W
T <sub>stg</sub>	Storage temperature range	-65 to + 175	°C
T <sub>j</sub>	Maximum operating junction temperature <sup>(1)</sup>	175	°C
dV/dt	Critical rate of rise of reverse voltage	10000	V/μs

1.  $\frac{dP_{tot}}{dT_j} < \frac{1}{R_{th(j-a)}}$  condition to avoid thermal runaway for a diode on its own heatsink

**Table 3. Thermal resistance**

Symbol	Parameter	Value	Unit
R <sub>th(j-l)</sub>	Junction to lead	SMA	30
		SMB	25
		SMAflat	25
			°C/W

**Table 4. Static electrical characteristics**

Symbol	Parameter	Test conditions	Min.	Typ.	Max.	Unit
I <sub>R</sub> <sup>(1)</sup>	Reverse leakage current	T <sub>j</sub> = 25 °C			4	μA
		T <sub>j</sub> = 125 °C	V <sub>R</sub> = V <sub>RRM</sub>	0.2	0.5	mA
V <sub>F</sub> <sup>(2)</sup>	Forward voltage drop	T <sub>j</sub> = 25 °C	I <sub>F</sub> = 1 A		0.77	V
		T <sub>j</sub> = 125 °C		0.58	0.62	
		T <sub>j</sub> = 25 °C	I <sub>F</sub> = 2 A		0.86	
		T <sub>j</sub> = 125 °C		0.65	0.7	

1. Pulse test: t<sub>p</sub> = 5 ms, δ < 2%

2. Pulse test: t<sub>p</sub> = 380 μs, δ < 2%

To evaluate the conduction losses use the following equation:

$$P = 0.54 \times I_{F(AV)} + 0.08 I_{F(RMS)}^2$$

Figure 1. Average forward power dissipation versus average forward current

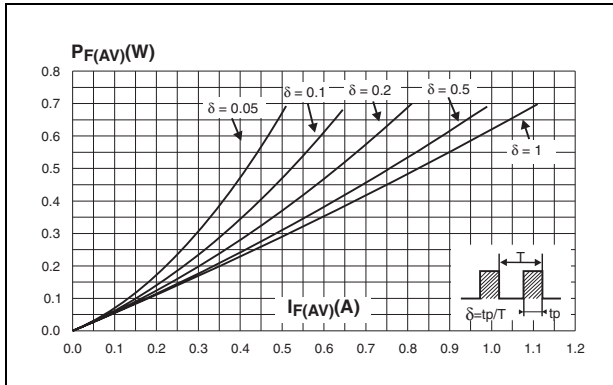

Figure 2. Average forward current versus ambient temperature ( $\delta = 0.5$ )

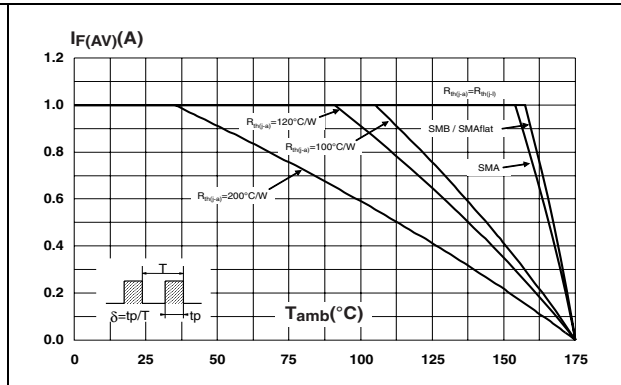

Figure 3. Normalized avalanche power derating versus pulse duration

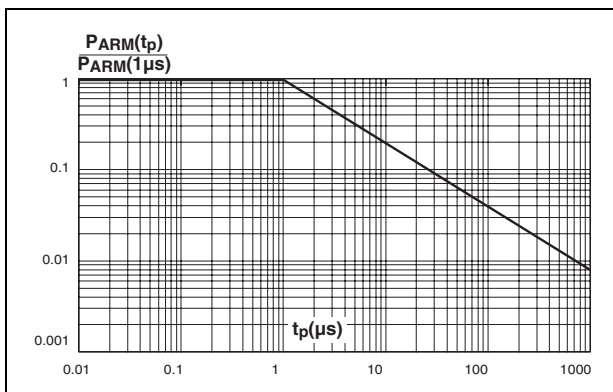

Figure 4. Normalized avalanche power derating versus junction temperature

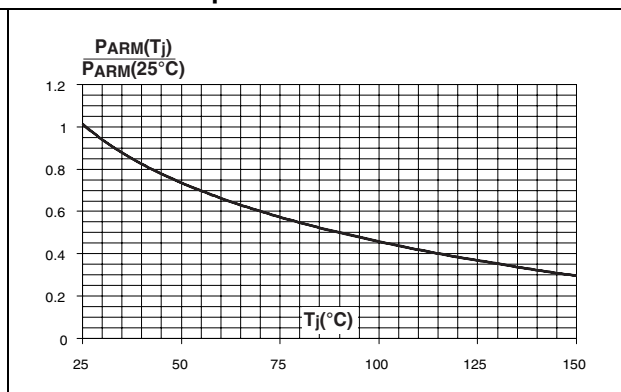

Figure 5. Non repetitive surge peak forward current versus overload duration (maximum values) (SMB)

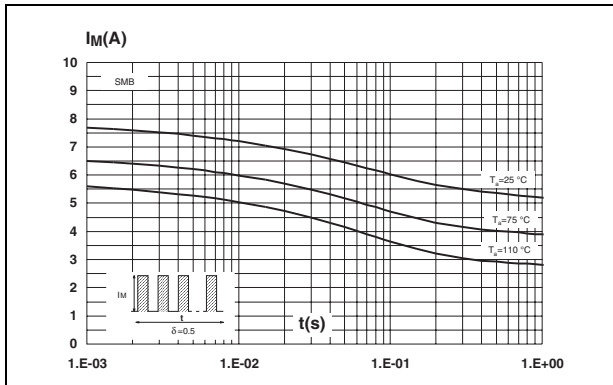
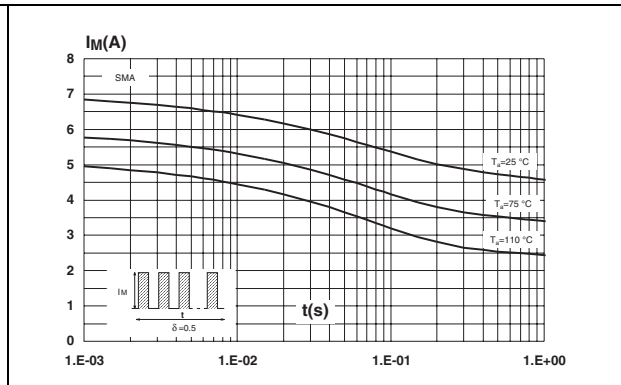
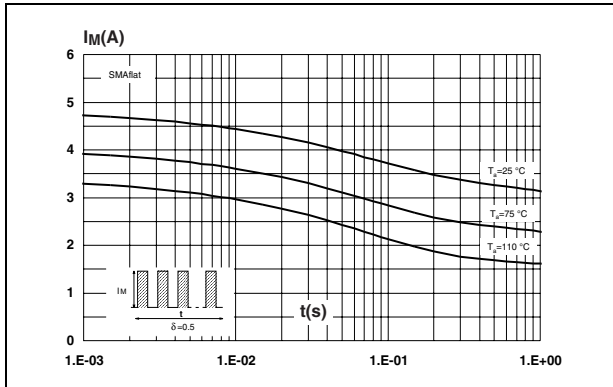

Figure 6. Non repetitive surge peak forward current versus overload duration (maximum values) (SMA)



**Figure 7. Non repetitive surge peak forward current versus overload duration (maximum values) (SMAflat)**



**Figure 8. Relative variation of thermal impedance junction to ambient versus pulse duration (SMB)**

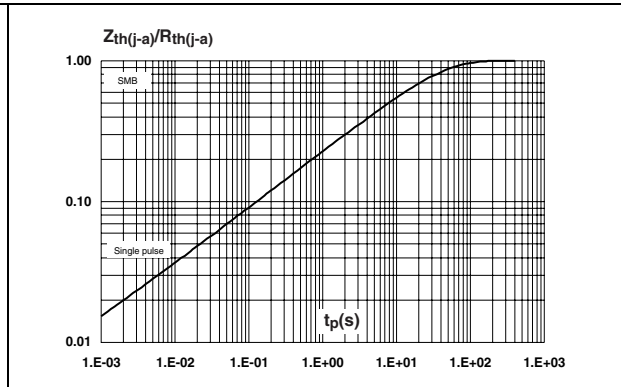

**Figure 9. Relative variation of thermal impedance junction to ambient versus pulse duration (SMA)**

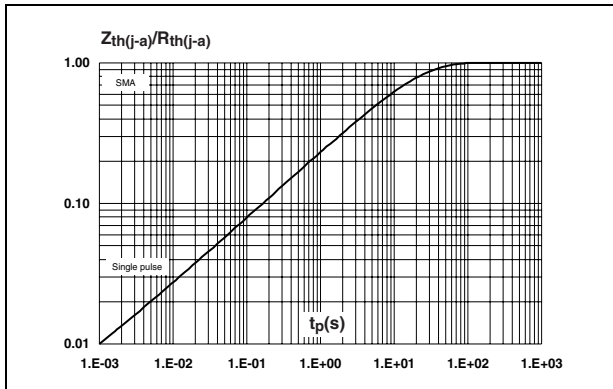

**Figure 10. Relative variation of thermal impedance junction to ambient versus pulse duration (SMAflat)**

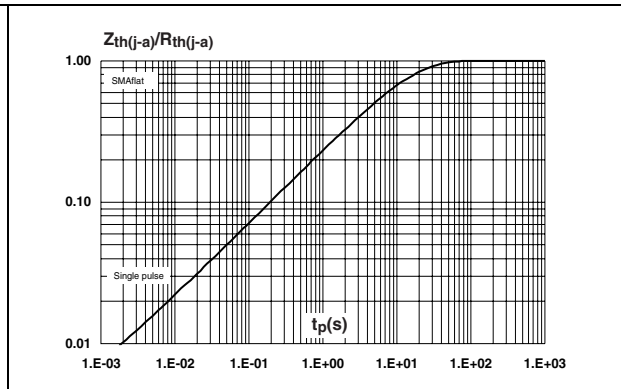

**Figure 11. Reverse leakage current versus reverse voltage applied (typical values)**

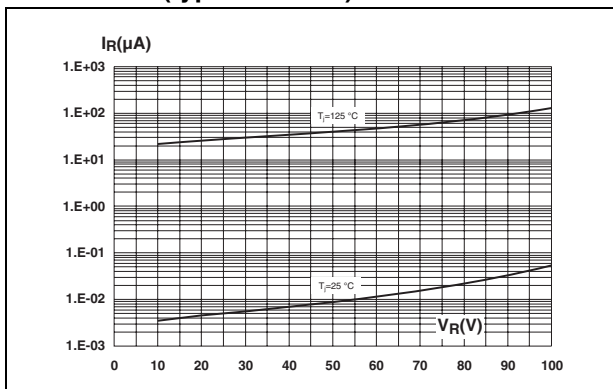

**Figure 12. Junction capacitance versus reverse voltage applied (typical values)**

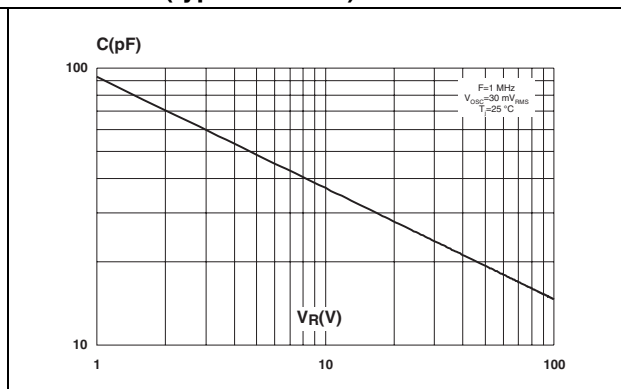

Figure 13. Forward voltage drop versus forward current (maximum values)

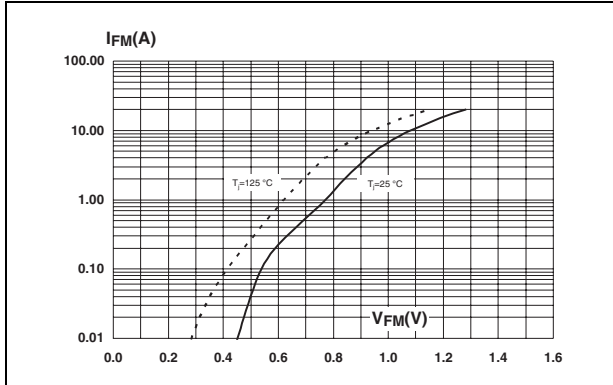

Figure 14. Thermal resistance junction to ambient versus copper surface under each lead (Epoxy printed circuit board FR4, copper thickness: 35 µm) (SMB)

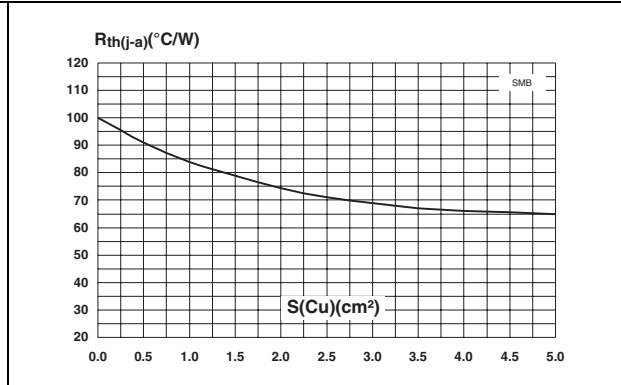

Figure 15. Thermal resistance junction to ambient versus copper surface under each lead (Epoxy printed circuit board FR4, copper thickness: 35 µm) (SMA)

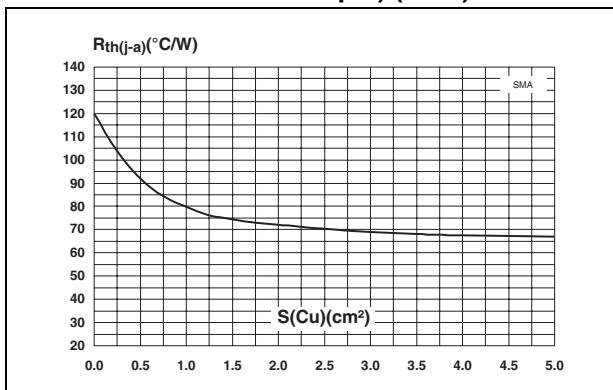
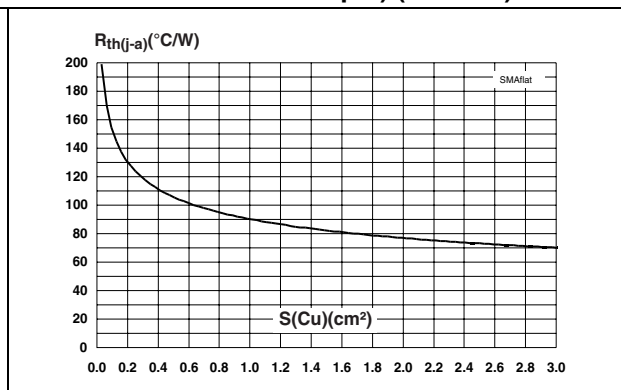

Figure 16. Thermal resistance junction to ambient versus copper surface under each lead (Epoxy printed circuit board FR4, copper thickness: 35 µm) (SMAflat)



## 2 Package information

- Epoxy meets UL94, V0

In order to meet environmental requirements, ST offers these devices in ECOPACK® packages. These packages have a lead-free second level interconnect. The category of second level interconnect is marked on the package and on the inner box label, in compliance with JEDEC Standard JESD97. The maximum ratings related to soldering conditions are also marked on the inner box label. ECOPACK is an ST trademark. ECOPACK specifications are available at [www.st.com](http://www.st.com).

Figure 17. SMA package dimensions

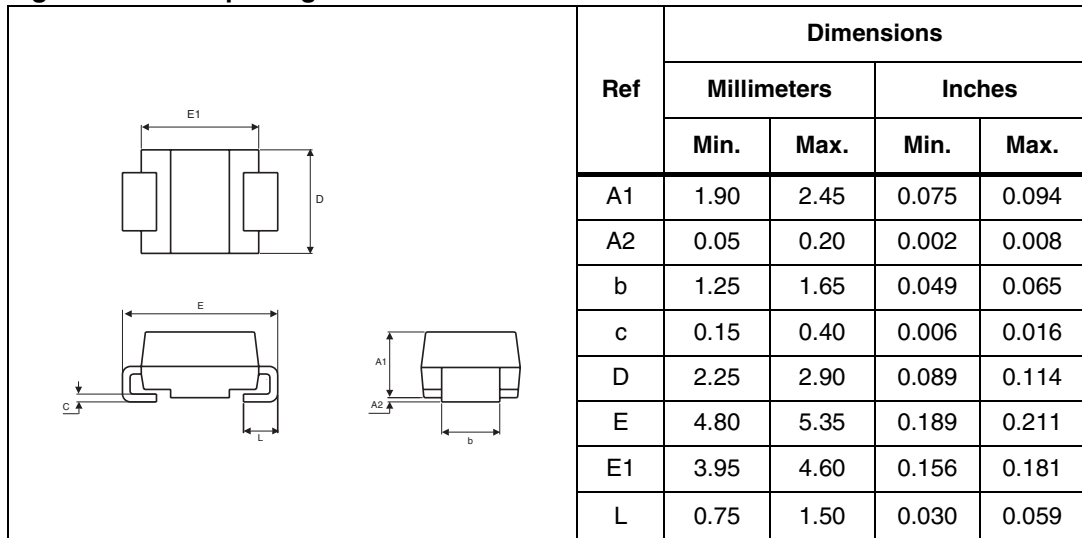

Figure 18. SMA footprint dimensions in millimeters (inches)      Figure 19. Marking information

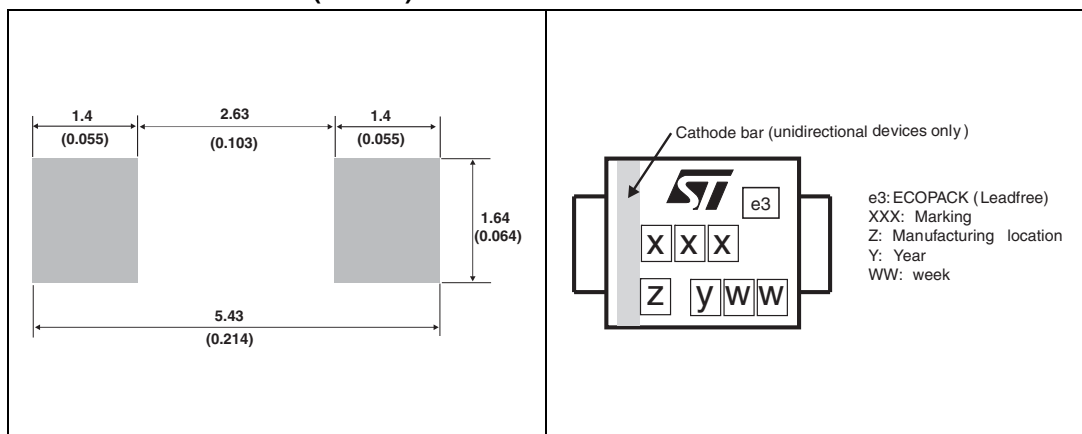

Figure 20. SMB package dimensions

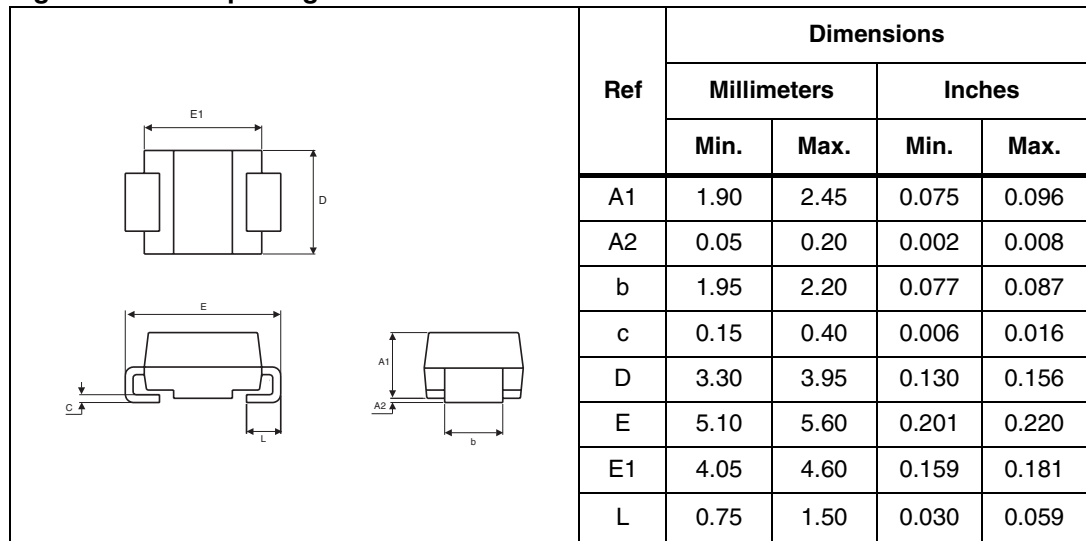
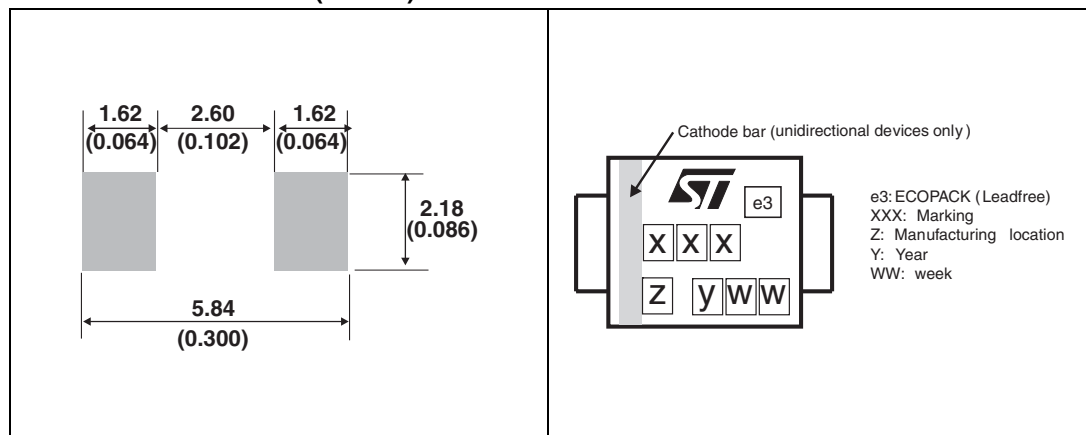

Figure 21. SMB footprint dimensions in millimeters (inches)      Figure 22. Marking information



**Table 5. SMAflat dimensions**

Ref.	Dimensions					
	Millimeters			Inches		
	Min.	Typ.	Max.	Min.	Typ.	Max.
A	0.90		1.10	0.035		0.043
b	1.25		1.65	0.049		0.065
c	0.15		0.40	0.006		0.016
D	2.25		2.95	0.088		0.116
E	4.80		5.60	0.189		0.220
E1	3.95		4.60	0.156		0.181
L	0.75		1.50	0.030		0.059
L1		0.50			0.019	
L2		0.50			0.019	

**Figure 23. SMAflat footprint dimensions** **Figure 24. Marking information optimized for SMAflat<sup>(1)</sup>**

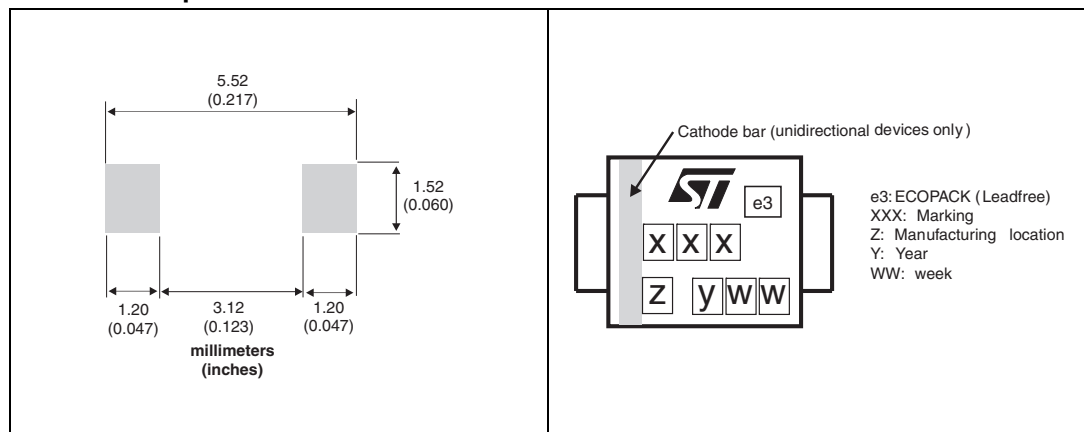

1. SMA footprint may also be used.



### 3 Ordering information

**Table 6. Ordering information**

Ordering type	Marking	Package	Weight	Base qty	Delivery mode
STPS1H100A	S11	SMA	0.068 g	5000	Tape and reel
STPS1H100U	G11	SMB	0.107 g	2500	Tape and reel
STPS1H100AF	F11	SMAflat	0.035 g	10 000	Tape and reel

### 4 Revision history

**Table 7. Document revision history**

Date	Revision	Description of changes
Jul-2003	4A	Last update.
Aug-2004	5	SMA package dimensions update. Reference A1 max changed from 2.70 mm (0.106 inc.) to 2.03 mm (0.080 inc).
18-Sep-2008	6	Reformatted to current standards. Added SMAflat package.

**Please Read Carefully:**

Information in this document is provided solely in connection with ST products. STMicroelectronics NV and its subsidiaries ("ST") reserve the right to make changes, corrections, modifications or improvements, to this document, and the products and services described herein at any time, without notice.

All ST products are sold pursuant to ST's terms and conditions of sale.

Purchasers are solely responsible for the choice, selection and use of the ST products and services described herein, and ST assumes no liability whatsoever relating to the choice, selection or use of the ST products and services described herein.

No license, express or implied, by estoppel or otherwise, to any intellectual property rights is granted under this document. If any part of this document refers to any third party products or services it shall not be deemed a license grant by ST for the use of such third party products or services, or any intellectual property contained therein or considered as a warranty covering the use in any manner whatsoever of such third party products or services or any intellectual property contained therein.

**UNLESS OTHERWISE SET FORTH IN ST'S TERMS AND CONDITIONS OF SALE ST DISCLAIMS ANY EXPRESS OR IMPLIED WARRANTY WITH RESPECT TO THE USE AND/OR SALE OF ST PRODUCTS INCLUDING WITHOUT LIMITATION IMPLIED WARRANTIES OF MERCHANTABILITY, FITNESS FOR A PARTICULAR PURPOSE (AND THEIR EQUIVALENTS UNDER THE LAWS OF ANY JURISDICTION), OR INFRINGEMENT OF ANY PATENT, COPYRIGHT OR OTHER INTELLECTUAL PROPERTY RIGHT.**

**UNLESS EXPRESSLY APPROVED IN WRITING BY AN AUTHORIZED ST REPRESENTATIVE, ST PRODUCTS ARE NOT RECOMMENDED, AUTHORIZED OR WARRANTED FOR USE IN MILITARY, AIR CRAFT, SPACE, LIFE SAVING, OR LIFE SUSTAINING APPLICATIONS, NOR IN PRODUCTS OR SYSTEMS WHERE FAILURE OR MALFUNCTION MAY RESULT IN PERSONAL INJURY, DEATH, OR SEVERE PROPERTY OR ENVIRONMENTAL DAMAGE. ST PRODUCTS WHICH ARE NOT SPECIFIED AS "AUTOMOTIVE GRADE" MAY ONLY BE USED IN AUTOMOTIVE APPLICATIONS AT USER'S OWN RISK.**

Resale of ST products with provisions different from the statements and/or technical features set forth in this document shall immediately void any warranty granted by ST for the ST product or service described herein and shall not create or extend in any manner whatsoever, any liability of ST.

ST and the ST logo are trademarks or registered trademarks of ST in various countries.

Information in this document supersedes and replaces all information previously supplied.

The ST logo is a registered trademark of STMicroelectronics. All other names are the property of their respective owners.

© 2008 STMicroelectronics - All rights reserved

STMicroelectronics group of companies

Australia - Belgium - Brazil - Canada - China - Czech Republic - Finland - France - Germany - Hong Kong - India - Israel - Italy - Japan - Malaysia - Malta - Morocco - Singapore - Spain - Sweden - Switzerland - United Kingdom - United States of America

[www.st.com](http://www.st.com)