

Data sheet

Commercial Art.No.: 92.934.0053.0

Connector GST18I3F S2 ZR1 WS

GST18i3 connector, 3 pole, male with spring force connection, coding mains 250 V, 20 A, coding color white, strain relief color white



Commercial Art.No.	92.934.0053.0
EAN	4015573402553
Order Unit	1

Certificates / Approvals



Technical data

General

Rated current	20 A
Rated voltage	250 V
Rated impulse voltage	4 kV
strain relief	yes
Pollution degree	2
Mechanical coding	Code 1
Lockable	self-locking (unlocking by tool)
Color of coding/ contact carrier	white
Marking of poles	L, N, PE
Color of housing inclusive strain relief	white

Connection Data

Cable diameter max.	10.3 mm
Cable diameter min.	7.8 mm
Connection cross section solid mm ² max.	2.5 mm ²
Connection cross section solid mm ² min.	0.5 mm ²
Connection cross section fine stranded mm ² max.	1.5 mm ²
Connection cross section fine stranded mm ² min.	0.5 mm ²
Terminations per pole	2
sheath strip length	45 mm
Wire strip length	9 mm

Model

Model	male
Connection type	spring clamp connection
Degree of protection (IP)	IP20

Remark to type of connection	fine- and multi stranded wires require a ferrule or a ultra sonically compacting
------------------------------	--

Material

Housing material	Polyamide
halogen free	yes
Contact material	CuZn
Fire load	0.121 kWh
Insulation components continuous temperature	100 °C
Surface finish	Tin-plated

Dimensions

Length	75 mm
Width	32.5 mm
Height	15.5 mm

Classification

ECLASS 11	
ECLASS 8.1	27440605
ETIM 7.0	EC002560
ETIM 6.0	EC002560
ETIM 5.0	EC002560
ETIM 4.0	EC002560

Product compliance

ROHS conformity status	Compliant/Exempted
ROHS exceptions	III-6(c)
REACH-SVHC conformity status	Duty-To-Declare
REACH-SVHC substances	Lead
REACH-SVHC CAS numbers	7439-92-1

Accessories

Commercial Art.No.:	Article-type description:	Description:
05.587.3156.0	Lock (G)ST18 WS	Locking device for cable to cable connection GST18i3-5, white
06.561.7853.0	mounting frame GST18i3 SW	Mounting frame to snap in GST18i3 connectors into a housing or furniture. Wall thickness: 1,5-2,5 mm. Holds GST18i3 connectors with screw or spring connection and pre- assembled cables.
05.561.3653.0	cover cap GST18i3VS B WS	Cover piece for female GST18i3, white
05.561.3653.1	cover cap GST18i3VS B SW	Cover piece for female GST18i3, black
05.564.5353.0	cover cap GST18i3/4/5 SW	Cover piece 12 pole black for female parts GST18i3-6
05.564.5353.2	cover cap GST18i3/4/5 WS	Cover piece 12 pole white for female parts GST18i3-6
05.594.4250.0	cover cap ST18/3B + GST18i3 ST WS	
05.594.4253.0	cover cap ST18/3B + GST18i3 ST WS	
05.587.3156.1	Lock (G)ST18 SW	Locking device for cable to cable connection GST18i3-5, black

Fits with

Commercial Art.No.:	Article-type description:	Description:

92.933.0053.0	Connector GST18i3F B2 ZR1 WS	GST18i3 connector, 3 pole, female with spring force connection, coding mains 250 V, 20 A, coding color white, strain relief color white
92.033.0058.0	Device connector GST18i3L B1H WS	GST18i3 PCB mount with additional mounting option, 3 pole, female (horizontal), coding mains 250 V, 20 A, coding color white
92.232.1007.2	Cable assembly GST18i3K1BD 15 10WS	GST18i3 mains-extension cable female - Schuko®, length 1.0 m, 3 pole, coding mains 250 V, 16 A, coding color white, strain relief color white, cable color white, cross section 1.5 mm ² , cable type H05VV-F, fire class: Eca
92.033.0158.0	Device connector GST18i3L B1H GR01	GST18i3 PCB mount with additional mounting option, 3 pole, female (horizontal), coding UPS 250 V, 20 A, coding color pebble grey
92.033.0658.0	Device connector GST18i3L B1H BR05	GST18i3 PCB mount with additional mounting option, 3 pole, female (horizontal), coding switching function 250 V, 20 A, coding color brown
92.232.1000.2	Cable assembly GST18i3K1BS 15 10WS	GST18i3 connection cable female - male, length 1.0 m, 3 pole, coding mains 250 V, 16 A, coding color white, strain relief color white, cable color white, cross section 1.5 mm ² , cable type H05VV-F, fire class: Eca
92.232.1003.2	Cable assembly GST18i3K1B- 15 10WS	GST18i3 extension cable female - free end, length 1.0 m, 3 pole, coding mains 250 V, 16 A, coding color white, strain relief color white, cable color white, cross section 1.5 mm ² , cable type H05VV-F, fire class: Eca
92.232.1004.2	Cable assembly GST18i3K1-S 15 10WS	GST18i3 extension cable male - free end, length 1.0 m, 3 pole, coding mains 250 V, 16 A, coding color white, strain relief color white, cable color white, cross section 1.5 mm ² , cable type H05VV-F, fire class: Eca
92.297.1003.0	Cable assembly GST18i3KSB- 15 10TR01	GST18i3 extension cable female - free end, length 1.0 m, 3 pole, coding UPS 250 V, 16 A, coding color tomato red, strain relief color black, cable color black, cross section 1.5 mm ² , cable type H05VV-F, fire class: Eca
92.033.0758.0	Device connector GST18i3L B1H RT03	GST18i3 PCB mount with additional mounting option, 3 pole, female (horizontal), coding mains 250 V, 20 A, coding color salmon pink
92.033.0858.0	Device connector GST18i3L B1H H RT03	Device connector, PCB mount, GST18i3, 3 pole, horizontal, with fixing hooks, female, 250 V, 20 A, colour of coding: salmon red
92.033.0358.0	Device connector GST18i3L B1H GN07	geisis® device connector, PCB mount, GST18i3, 3 pole, horizontal, female, 250 V, 20 A, colour of coding: may green
92.033.0558.0	Device connector GST18i3L B1H TB06	GST18i3 PCB mount with additional mounting option, 3 pole, female (horizontal), coding mains 250 V, 20 A, coding color turquoise blue
92.033.0458.0	Device connector GST18i3L B1H PB04	GST18i3 PCB mount with additional mounting option, 3 pole, female (horizontal), coding not SELV, 20 A, coding color pastel blue

These dimensions will be especially checked at delivery
 Only inspection dimensions
 With /E marked dimensions are only valid for internal use

Diese Maße werden bei Abnahme besonders geprüft
 Ausschließliche Prüfmaße
 Mit /E gekennzeichnete Maße sind nur für interne Zwecke gültig

○

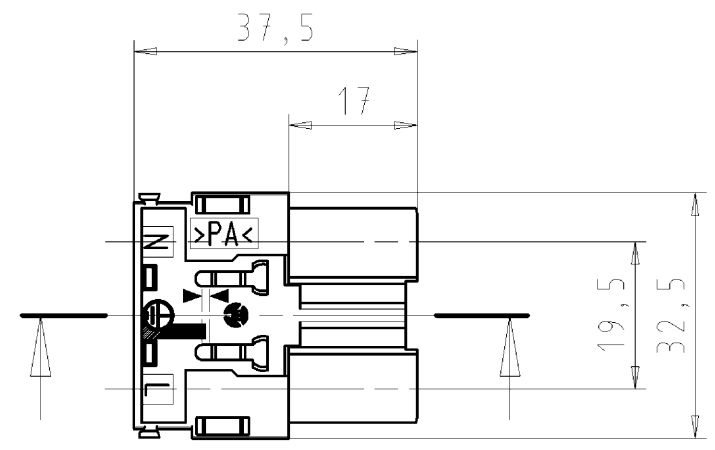
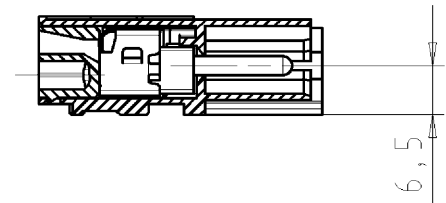
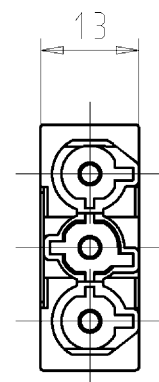
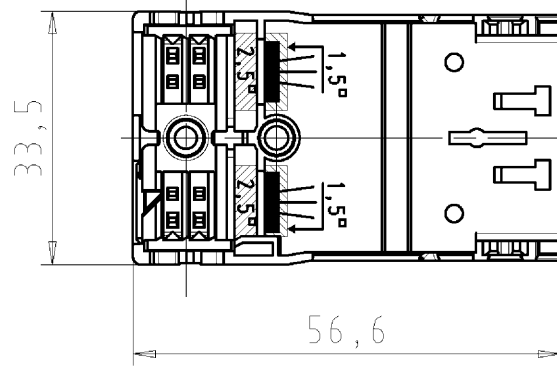
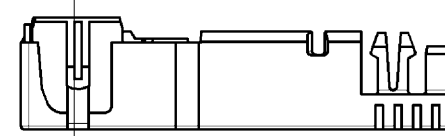
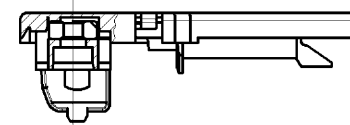
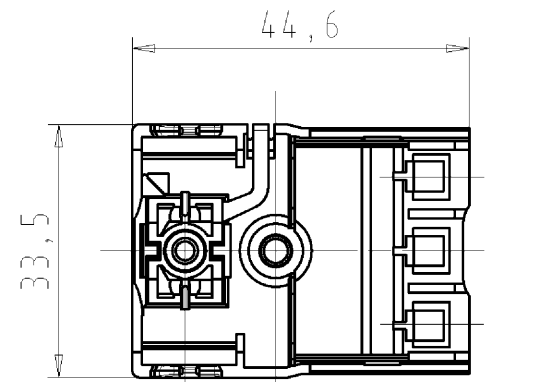

Typ/type: GST18I3F S2 ZR1 WS/SW/TR

Weitere Daten siehe Katalog
 further data see catalog

Teile - Nr. part number	Farbe colour
92.934.0053.0	weiß / white
92.934.0053.1	schwarz /black
92.934.0053.5	tomatenrot/tomato red Zugentlastung: schwarz spring clamp connection: black

Tolerierung Size ISO 14405/Tolerance system Size ISO 14405. (This ISO-standard describes the envelope principle. According to the envelope principle the deviations of form and parallelism are limited by the size tolerances).				ja/yes <input checked="" type="checkbox"/> Stoffverbots- und Deklarationsliste nach UU-TOM-05/03 ist einzuhalten. Conformity with Wieland document UU-TOM-05/03 (list of prohibited / declarable hazardous substances) to be declared!			
Freitoleranz nach General tolerance		CAD - Zeichnung, keine manuellen Änderungen CAD - drawing, no manual modifications allowed		1. Verwendung: First Use:		Blatt: 1 von 1 Sheet: of 1	
/		Werkstoff/Material		2007 Tag/Date Name		Zeichnung Nr./Drawing No. Index	
/		Maßstab/Scale		gezeichnet drawn 22.05. Schmitt J.		T 92.934.0053.0 01K a	
/		1:1		geprüft checked - -		Maße in mm/Dimensions are in mm	
/		Vol. mm³		Ofl./Surf. mm²		Ersatz für/Replacement for: -	
/		wieland		Type		Benennung/Tittle MALE CONNECTOR WITH STRAIN RELIEF	
a 22.01.2013/		Elektrische Verbindungen		Index		STECKERTE IL MIT ZUGENTLASTUNG	
Index Datum / Blatt Date / Sheet						Federkraftanschluss/ spring clamp connection	
Änderung/Revision						ⓐ 250V AC, 20A, 2,5qmm	

Weitergabe sowie Vervielfältigung dieses Dokuments, Verwertung und Mitteilung seines Inhalts sind verboten, soweit nicht ausdrücklich gestattet.
 The reproduction, distribution and utilization of this document as well as the communication of its contents to others without express authorization is prohibited.

929340053001K_2 CADW3028_Treschan 2013-01-22T15:17:42 1.000