

Power MOSFET



RoHS
COMPLIANT
HALOGEN
FREE
Available

PRODUCT SUMMARY		
V_{DS} (V)	200	
$R_{DS(on)}$ (Ω)	$V_{GS} = 10$ V	1.5
Q_g (Max.) (nC)	8.2	
Q_{gs} (nC)	1.8	
Q_{gd} (nC)	4.5	
Configuration	Single	

FEATURES

- Surface mount
- Available in tape and reel
- Dynamic dV/dt rating
- Repetitive avalanche rated
- Fast switching
- Ease of paralleling
- Simple drive requirements
- Material categorization: for definitions of compliance please see www.vishay.com/doc?99912

DESCRIPTION

Third generation power MOSFETs from Vishay provide the designer with the best combination of fast switching, ruggedized device design, low on-resistance and cost-effectiveness.

The SOT-223 package is designed for surface-mounting using vapor phase, infrared, or wave soldering techniques. Its unique package design allows for easy automatic pick-and-place as with other SOT or SOIC packages but has the added advantage of improved thermal performance due to an enlarged tab for heatsinking. Power dissipation of greater than 1.25 W is possible in a typical surface mount application.

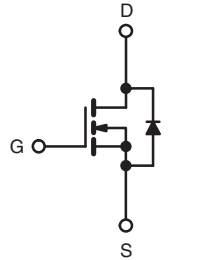
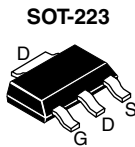

N-Channel MOSFET

Marking code: FC

ORDERING INFORMATION		
Package	SOT-223	SOT-223
Lead (Pb)-free and Halogen-free	SiHFL210-GE3	SiHFL210TR-GE3 ^a
Lead (Pb)-free	IRFL210PbF	IRFL210TRPbF ^a
	SiHFL210-E3	SiHFL210T-E3 ^a

Note

a. See device orientation.

ABSOLUTE MAXIMUM RATINGS ($T_C = 25$ °C, unless otherwise noted)			
PARAMETER	SYMBOL	LIMIT	UNIT
Drain-Source Voltage	V_{DS}	200	V
Gate-Source Voltage	V_{GS}	± 20	
Continuous Drain Current	V_{GS} at 10 V	$T_C = 25$ °C	A
		$T_C = 100$ °C	
Pulsed Drain Current ^a	I_{DM}	7.7	W/°C
Linear Derating Factor		0.025	
Linear Derating Factor (PCB Mount) ^e		0.017	
Single Pulse Avalanche Energy ^b	E_{AS}	50	mJ
Repetitive Avalanche Current ^a	I_{AR}	0.96	A
Repetitive Avalanche Energy ^a	E_{AR}	0.31	mJ
Maximum Power Dissipation	P_D	$T_C = 25$ °C	W
		$T_A = 25$ °C	
Peak Diode Recovery dV/dt ^c	dV/dt	5.0	V/ns
Operating Junction and Storage Temperature Range	T_J, T_{stg}	-55 to +150	°C
Soldering Recommendations (Peak Temperature) ^d	for 10 s	300	

Notes

- Repetitive rating; pulse width limited by maximum junction temperature (see fig. 11).
- $V_{DD} = 50$ V, starting $T_J = 25$ °C, $L = 81$ mH, $R_G = 25$ Ω , $I_{AS} = 0.96$ A (see fig. 12).
- $I_{SD} \leq 3.3$ A, $dI/dt \leq 70$ A/ μ s, $V_{DD} \leq V_{DS}$, $T_J \leq 150$ °C.
- 1.6 mm from case.
- When mounted on 1" square PCB (FR-4 or G-10 material).



THERMAL RESISTANCE RATINGS					
PARAMETER	SYMBOL	MIN.	TYP.	MAX.	UNIT
Maximum Junction-to-Ambient (PCB Mount) ^a	R _{thJA}	-	-	40	°C/W
Maximum Junction-to-Case (Drain)	R _{thJC}	-	-	60	

Note

a. When mounted on 1" square PCB (FR-4 or G-10 material).

SPECIFICATIONS (T _J = 25 °C, unless otherwise noted)							
PARAMETER	SYMBOL	TEST CONDITIONS		MIN.	TYP.	MAX.	UNIT
Static							
Drain-Source Breakdown Voltage	V _{DS}	V _{GS} = 0 V, I _D = 250 μA		200	-	-	V
V _{DS} Temperature Coefficient	ΔV _{DS} /T _J	Reference to 25 °C, I _D = 1 mA		-	0.30	-	V/°C
Gate-Source Threshold Voltage	V _{GS(th)}	V _{DS} = V _{GS} , I _D = 250 μA		2.0	-	4.0	V
Gate-Source Leakage	I _{GSS}	V _{GS} = ± 20 V		-	-	± 100	nA
Zero Gate Voltage Drain Current	I _{DSS}	V _{DS} = 200 V, V _{GS} = 0 V		-	-	25	μA
		V _{DS} = 160 V, V _{GS} = 0 V, T _J = 125 °C		-	-	250	
Drain-Source On-State Resistance	R _{DS(on)}	V _{GS} = 10 V	I _D = 0.58 A ^b	-	-	1.5	Ω
Forward Transconductance	g _{fs}	V _{DS} = 50 V, I _D = 0.58 A		0.51	-	-	S
Dynamic							
Input Capacitance	C _{iss}	V _{GS} = 0 V, V _{DS} = 25 V, f = 1.0 MHz, see fig. 5		-	140	-	pF
Output Capacitance	C _{oss}			-	53	-	
Reverse Transfer Capacitance	C _{rss}			-	15	-	
Total Gate Charge	Q _g	V _{GS} = 10 V	I _D = 3.3 A, V _{DS} = 160 V, see fig. 6 and 13 ^b	-	-	8.2	nC
Gate-Source Charge	Q _{gs}			-	-	1.8	
Gate-Drain Charge	Q _{gd}			-	-	4.5	
Turn-On Delay Time	t _{d(on)}	V _{DD} = 100 V, I _D = 3.3 A, R _g = 24 Ω, R _D = 30 Ω, see fig. 10 ^b		-	8.2	-	ns
Rise Time	t _r			-	17	-	
Turn-Off Delay Time	t _{d(off)}			-	14	-	
Fall Time	t _f			-	8.9	-	
Internal Drain Inductance	L _D	Between lead, 6 mm (0.25") from package and center of die contact		-	4.0	-	nH
Internal Source Inductance	L _S			-	6.0	-	
Drain-Source Body Diode Characteristics							
Continuous Source-Drain Diode Current	I _S	MOSFET symbol showing the integral reverse p - n junction diode		-	-	0.96	A
Pulsed Diode Forward Current ^a	I _{SM}			-	-	7.7	
Body Diode Voltage	V _{SD}	T _J = 25 °C, I _S = 0.96 A, V _{GS} = 0 V ^b		-	-	2.0	V
Body Diode Reverse Recovery Time	t _{rr}	T _J = 25 °C, I _F = 3.3 A, dI/dt = 100 A/μs ^b		-	150	310	ns
Body Diode Reverse Recovery Charge	Q _{rr}			-	0.60	1.4	μC
Forward Turn-On Time	t _{on}	Intrinsic turn-on time is negligible (turn-on is dominated by L _S and L _D)					

Notes

a. Repetitive rating; pulse width limited by maximum junction temperature (see fig. 11).

b. Pulse width ≤ 300 μs; duty cycle ≤ 2 %.



TYPICAL CHARACTERISTICS (25 °C, unless otherwise noted)

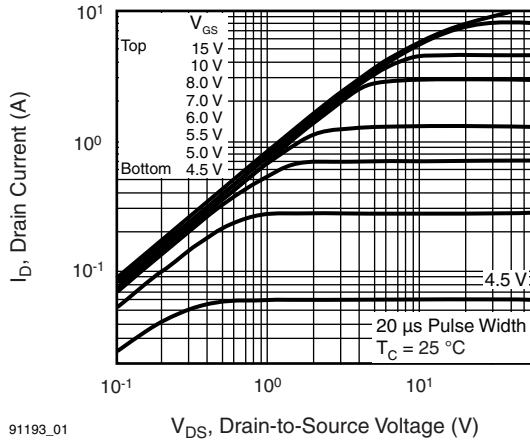

Fig. 1 - Typical Output Characteristics, $T_C = 25\text{ }^\circ\text{C}$

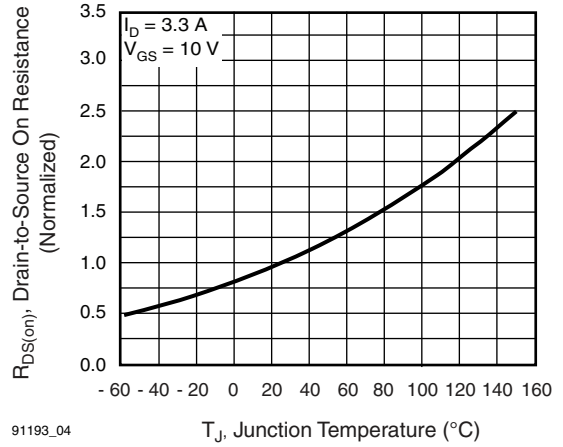

Fig. 4 - Normalized On-Resistance vs. Temperature

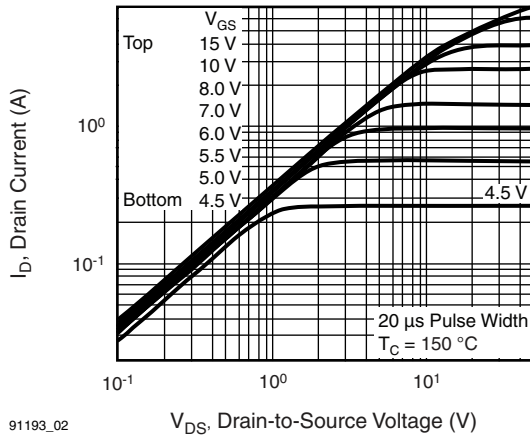

Fig. 2 - Typical Output Characteristics, $T_C = 150\text{ }^\circ\text{C}$

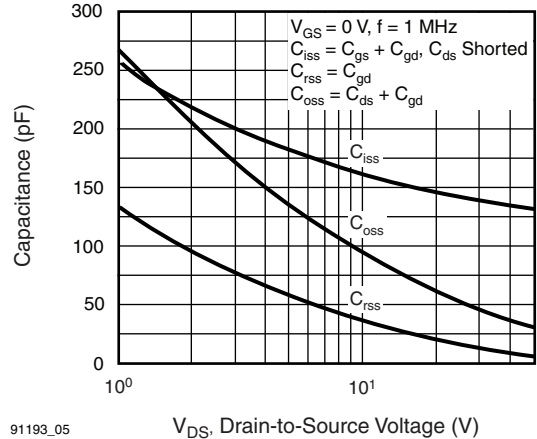

Fig. 5 - Typical Capacitance vs. Drain-to-Source Voltage

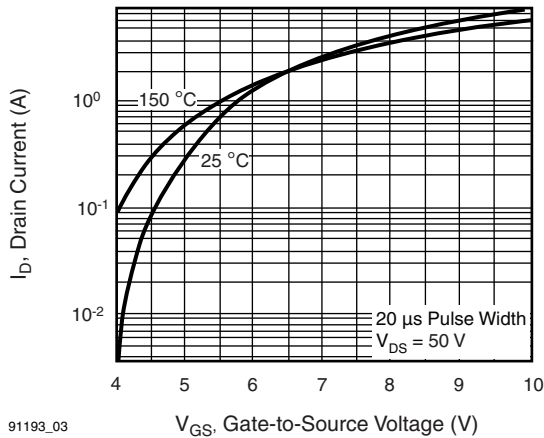

Fig. 3 - Typical Transfer Characteristics

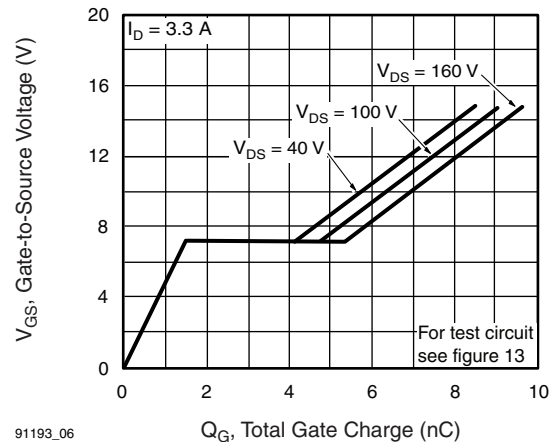

Fig. 6 - Typical Gate Charge vs. Gate-to-Source Voltage

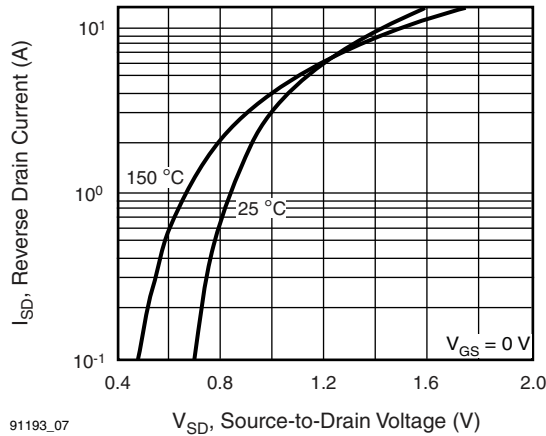

Fig. 7 - Typical Source-Drain Diode Forward Voltage

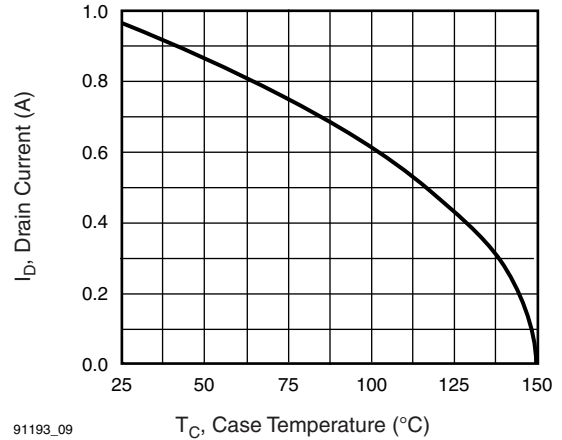

Fig. 9 - Maximum Drain Current vs. Case Temperature

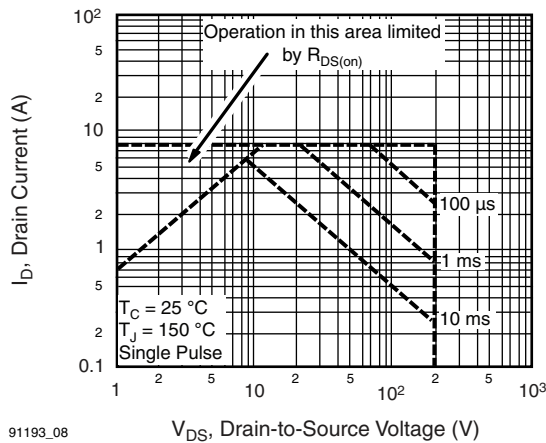

Fig. 8 - Maximum Safe Operating Area

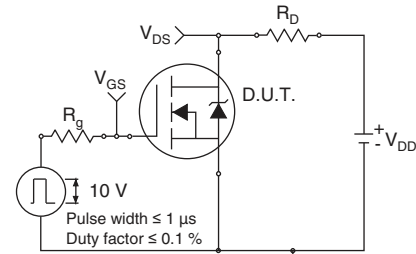

Fig. 10a - Switching Time Test Circuit

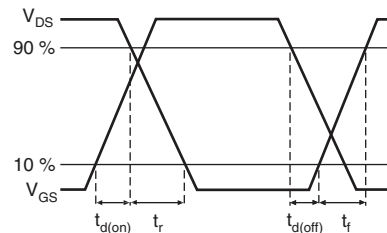

Fig. 10b - Switching Time Waveforms

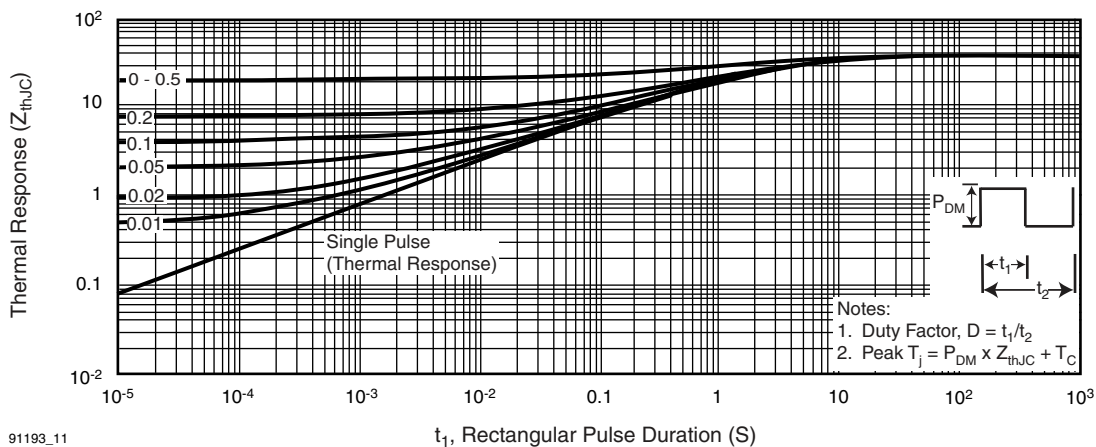

Fig. 11 - Maximum Effective Transient Thermal Impedance, Junction-to-Case

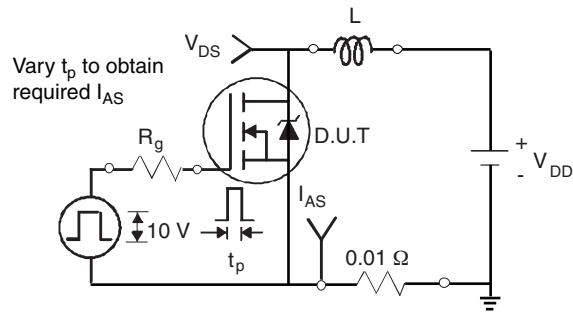

Fig. 12a - Unclamped Inductive Test Circuit

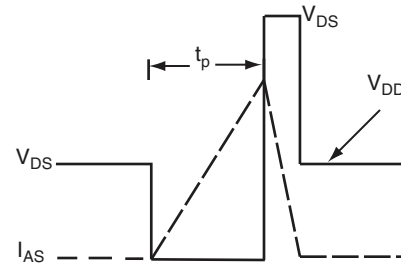

Fig. 12b - Unclamped Inductive Waveforms

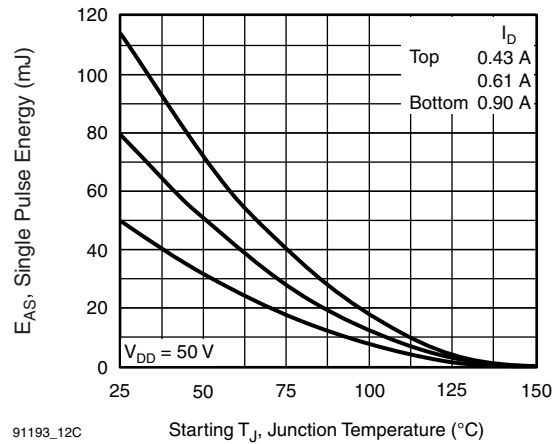

Fig. 12c - Maximum Avalanche Energy vs. Drain Current

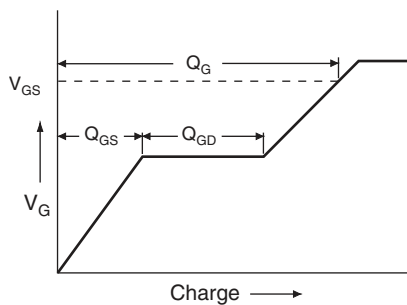

Fig. 13a - Basic Gate Charge Waveform

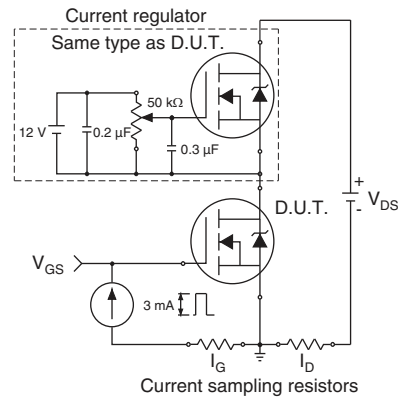
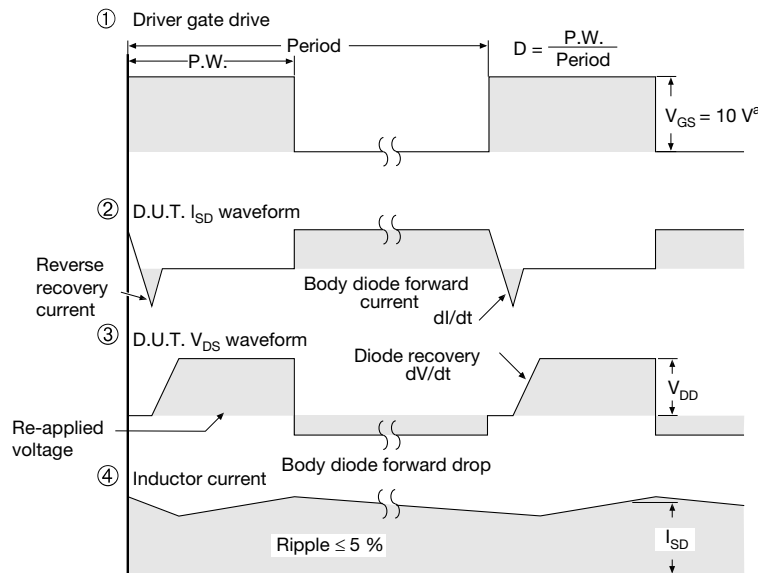
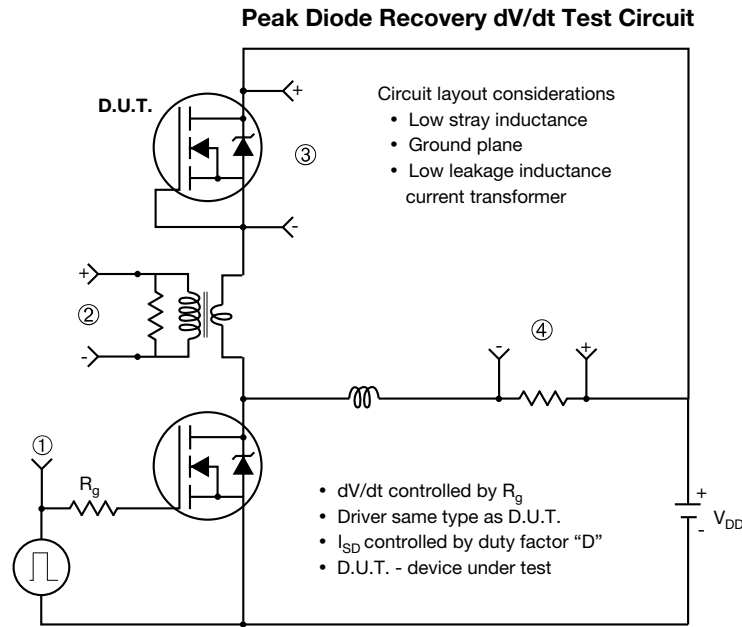

Fig. 13b - Gate Charge Test Circuit



Note
a. $V_{GS} = 5\text{ V}$ for logic level devices

Fig. 14 - For N-Channel

Vishay Siliconix maintains worldwide manufacturing capability. Products may be manufactured at one of several qualified locations. Reliability data for Silicon Technology and Package Reliability represent a composite of all qualified locations. For related documents such as package/tape drawings, part marking, and reliability data, see www.vishay.com/ppg?91193.

SOT-223 (HIGH VOLTAGE)

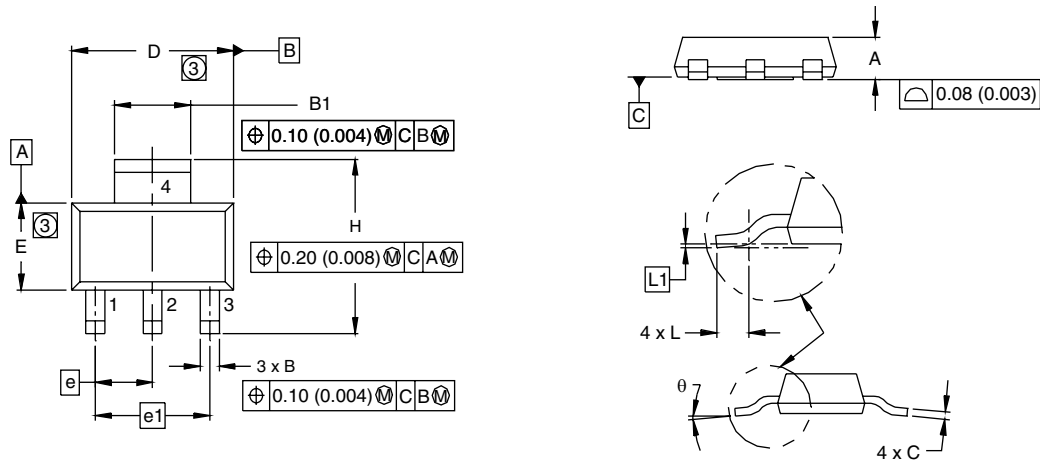

DIM.	MILLIMETERS		INCHES	
	MIN.	MAX.	MIN.	MAX.
A	1.55	1.80	0.061	0.071
B	0.65	0.85	0.026	0.033
B1	2.95	3.15	0.116	0.124
C	0.25	0.35	0.010	0.014
D	6.30	6.70	0.248	0.264
E	3.30	3.70	0.130	0.146
e	2.30 BSC		0.0905 BSC	
e1	4.60 BSC		0.181 BSC	
H	6.71	7.29	0.264	0.287
L	0.91	-	0.036	-
L1	0.061 BSC		0.0024 BSC	
θ	-	10'	-	10'

ECN: S-82109-Rev. A, 15-Sep-08
DWG: 5969

Notes

1. Dimensioning and tolerancing per ASME Y14.5M-1994.
2. Dimensions are shown in millimeters (inches).
3. Dimension do not include mold flash.
4. Outline conforms to JEDEC outline TO-261AA.



Disclaimer

ALL PRODUCT, PRODUCT SPECIFICATIONS AND DATA ARE SUBJECT TO CHANGE WITHOUT NOTICE TO IMPROVE RELIABILITY, FUNCTION OR DESIGN OR OTHERWISE.

Vishay Intertechnology, Inc., its affiliates, agents, and employees, and all persons acting on its or their behalf (collectively, "Vishay"), disclaim any and all liability for any errors, inaccuracies or incompleteness contained in any datasheet or in any other disclosure relating to any product.

Vishay makes no warranty, representation or guarantee regarding the suitability of the products for any particular purpose or the continuing production of any product. To the maximum extent permitted by applicable law, Vishay disclaims (i) any and all liability arising out of the application or use of any product, (ii) any and all liability, including without limitation special, consequential or incidental damages, and (iii) any and all implied warranties, including warranties of fitness for particular purpose, non-infringement and merchantability.

Statements regarding the suitability of products for certain types of applications are based on Vishay's knowledge of typical requirements that are often placed on Vishay products in generic applications. Such statements are not binding statements about the suitability of products for a particular application. It is the customer's responsibility to validate that a particular product with the properties described in the product specification is suitable for use in a particular application. Parameters provided in datasheets and/or specifications may vary in different applications and performance may vary over time. All operating parameters, including typical parameters, must be validated for each customer application by the customer's technical experts. Product specifications do not expand or otherwise modify Vishay's terms and conditions of purchase, including but not limited to the warranty expressed therein.

Except as expressly indicated in writing, Vishay products are not designed for use in medical, life-saving, or life-sustaining applications or for any other application in which the failure of the Vishay product could result in personal injury or death. Customers using or selling Vishay products not expressly indicated for use in such applications do so at their own risk. Please contact authorized Vishay personnel to obtain written terms and conditions regarding products designed for such applications.

No license, express or implied, by estoppel or otherwise, to any intellectual property rights is granted by this document or by any conduct of Vishay. Product names and markings noted herein may be trademarks of their respective owners.

Material Category Policy

Vishay Intertechnology, Inc. hereby certifies that all its products that are identified as RoHS-Compliant fulfill the definitions and restrictions defined under Directive 2011/65/EU of The European Parliament and of the Council of June 8, 2011 on the restriction of the use of certain hazardous substances in electrical and electronic equipment (EEE) - recast, unless otherwise specified as non-compliant.

Please note that some Vishay documentation may still make reference to RoHS Directive 2002/95/EC. We confirm that all the products identified as being compliant to Directive 2002/95/EC conform to Directive 2011/65/EU.

Vishay Intertechnology, Inc. hereby certifies that all its products that are identified as Halogen-Free follow Halogen-Free requirements as per JEDEC JS709A standards. Please note that some Vishay documentation may still make reference to the IEC 61249-2-21 definition. We confirm that all the products identified as being compliant to IEC 61249-2-21 conform to JEDEC JS709A standards.