

TPS56x200 4.5-V To 17-V Input, 2-A, 3-A Synchronous Step-Down Voltage Regulator In 6 Pin SOT-23

1 Features

- TPS562200 - 2A converter with Integrated 122 mΩ and 72 mΩ FETs
- TPS563200 - 3A converter with Integrated 68 mΩ and 39 mΩ FETs
- D-CAP2™ Mode Control for Fast Transient Response
- Input Voltage Range: 4.5 V to 17 V
- Output Voltage Range: 0.76 V to 7 V
- 650 kHz Switching Frequency
- Advanced Eco-mode™ Pulse-skip
- Low Shutdown Current Less than 10 μA
- 1% Feedback Voltage Accuracy (25°C)
- Startup from Pre-Biased Output Voltage
- Cycle-By-Cycle Overcurrent Limit
- Hiccup-Mode Undervoltage Protection
- Non-latch OVP, UVLO and TSD Protections
- Fixed Soft Start: 1 ms
- Create a Custom Design Using the TPS56x200 with the [WEBENCH Power Designer](#)

2 Applications

- Digital TV Power Supply
- High Definition Blu-ray Disc™ Players
- Networking Home Terminal
- Digital Set Top Box (STB)

3 Description

The TPS562200 and TPS563200 are simple, easy-to-use, 2 A and 3 A synchronous step-down (buck) converters in 6 pin SOT-23 package.

The devices are optimized to operate with minimum external component counts and also optimized to achieve low standby current.

These switch mode power supply (SMPS) devices employ D-CAP2 mode control providing a fast transient response and supporting both low equivalent series resistance (ESR) output capacitors such as specialty polymer and ultra-low ESR ceramic capacitors with no external compensation components.

TPS562200 and TPS563200 operate in Advanced Eco-mode, which maintains high efficiency during light load operation. The devices are available in a 6-pin 1.6mm x 2.9mm SOT (DDC) package, and specified from -40°C to 85°C of ambient temperature.

Device Information⁽¹⁾

PART NUMBER	PACKAGE	BODY SIZE (NOM)
TPS562200	SOT (6)	1.60mm x 2.90mm
TPS563200		

(1) For all available packages, see the orderable addendum at the end of the datasheet.

Simplified Schematic

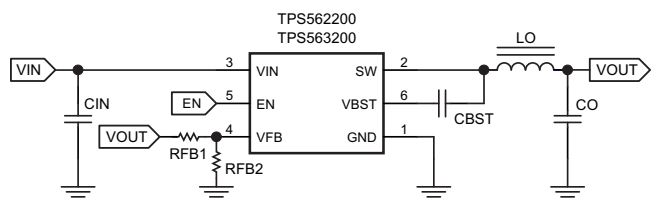

Copyright © 2016, Texas Instruments Incorporated

Tps562200 Efficiency

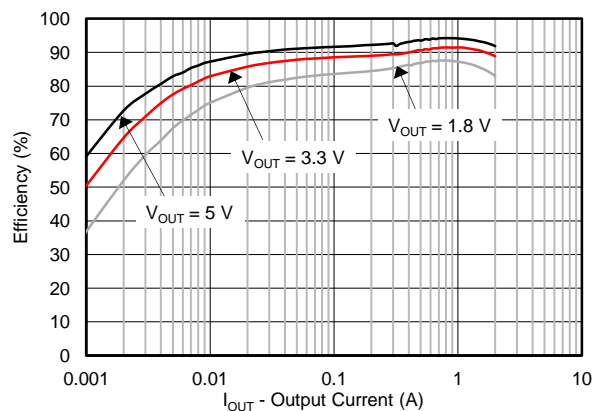

Table of Contents

1 Features	1	7.4 Device Functional Modes	13
2 Applications	1	8 Application And Implementation	14
3 Description	1	8.1 Application Information	14
4 Revision History	2	8.2 Typical Applications	14
5 Pin Configuration And Functions	4	9 Power Supply Recommendations	23
6 Specifications	5	10 Layout	24
6.1 Absolute Maximum Ratings	5	10.1 Layout Guidelines	24
6.2 ESD Ratings	5	10.2 Layout Example	24
6.3 Recommended Operating Conditions	5	11 Device And Documentation Support	25
6.4 Thermal Information	5	11.1 Custom Design with WEBENCH Tools	25
6.5 Electrical Characteristics	6	11.2 Receiving Notification of Documentation Updates	25
6.6 Timing Requirements	6	11.3 Related Links	25
6.7 Typical Characteristics TPS562200	7	11.4 Receiving Notification of Documentation Updates	25
6.8 Typical Characteristics TPS563200	9	11.5 Community Resources	25
7 Detailed Description	11	11.6 Trademarks	25
7.1 Overview	11	11.7 Electrostatic Discharge Caution	26
7.2 Functional Block Diagrams	11	11.8 Glossary	26
7.3 Feature Description	12	12 Mechanical, Packaging, And Orderable Information	26

4 Revision History

NOTE: Page numbers for previous revisions may differ from page numbers in the current version.

Changes from Revision C (August 2015) to Revision D	Page
• Updated the Pinout image in Pin Configuration And Functions	4
• Changed $R_{\theta JB}$ for TPS562200 From: 3.4 To: 13.4 in Thermal Information	5
• The Adaptive On-Time Control And PWM Operation , changed text From: "proportional to the converter input voltage, V_{IN} , and inversely proportional to the output voltage, V_O " To: "inversely proportional to the converter input voltage, V_{IN} , and proportional to the output voltage, V_O "	12

Changes from Revision B (July 2014) to Revision C	Page
• Changed Features From: Integrated 122 mΩ and 72 mΩ FETs ('562200) To: TPS562200 - 2A converter with Integrated 122 mΩ and 72 mΩ FETs	1
• Changed Features From: Integrated 68-mΩ and 39-mΩ FETs ('563200) To: TPS563200 - 3A converter with Integrated 68-mΩ and 39-mΩ FETs	1
• Added Features : 650 kHz Switching Frequency	1
• Changed Features From: Cycle-By-Cycle Hiccup Over-current Limit To: Cycle-By-Cycle Overcurrent Limit	1
• Added Features : Hiccup-Mode Undervoltage Protection	1
• Changed text in the first paragraph of the Description From: "...in SOT-23 package." To: "in 6 pin SOT-23 package."	1
• Moved Storage temperature range, T_{stg} From: Handling Ratings To: Absolute Maximum Ratings ⁽¹⁾	5
• Changed the Handling Ratings table to the ESD Ratings table	5
• Changed the TPS562200 Thermal Information values	5
• Changed V_{OVP} Description in the Electrical Characteristics From: OVP Detect (L > H) To: OVP Detect, and the TYP value From: 125% To: 125% x Vfbth	6
• Changed V_{UVP} Description in the Electrical Characteristics From: Hiccup detect (H < L) To: Hiccup detect, and the TYP value From: 65% To: 65% x Vfbth	6
• Changed the Output Current (A) scale of Figure 7	7
• Changed $V_{OUT} = 5 V$ To $V_{OUT} = 3.3 V$ in Figure 15	9
• Changed the X axis From: Junction Temperature To: Ambient Temperature in Figure 16	9

• Added a NOTE to the Application and Implementation section	14
• Changed column heading C8 + C9 (μF) To: C5 + C6 (μF) in Table 2	16
• Changed column heading C8 + C9 (μF) To: C5 + C6 + C7 (μF) in Table 2	20

Changes from Revision A (January 2014) to Revision B
Page

• Added <i>Feature Description</i> section, <i>Device Functional Modes</i> , <i>Application and Implementation</i> section, <i>Power Supply Recommendations</i> section, <i>Device and Documentation Support</i> section, and <i>Mechanical, Packaging, and Orderable Information</i> section	1
• Changed the data sheet title From: 4.5 V to 17 V Input, 2A Synchronous Step-Down.. To: 4.5 V to 17 V Input, 2A/3A Synchronous Step-Down.....	1
• Changed device number From: TPS563209 To TPS563200	1
• Changed Features From: 2% Feedback Voltage Accuracy (25°C) To: 1% Feedback Voltage Accuracy (25°C).....	1
• Added the Timing Requirements table	6
• Added Table 1	14
• Changed Table 2	16
• Deleted sentence following Table 2 "For higher output voltages, additional phase boost can be achieved by adding a feed forward capacitor (C7) in parallel with R2."	16
• Added Application Information for the TPS563200 device	20
• Added Table 3	20

Changes from Original (January 2014) to Revision A
Page

• Changed the device status From: Product Preview To: Production.....	1
---	---

5 Pin Configuration And Functions

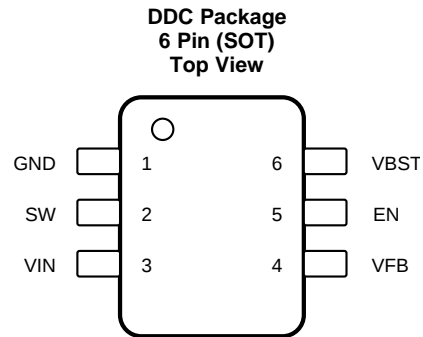

PIN		DESCRIPTION
NAME	NUMBER	
GND	1	Ground pin Source terminal of low-side power NFET as well as the ground terminal for controller circuit. Connect sensitive VFB to this GND at a single point.
SW	2	Switch node connection between high-side NFET and low-side NFET.
VIN	3	Input voltage supply pin. The drain terminal of high-side power NFET.
VFB	4	Converter feedback input. Connect to output voltage with feedback resistor divider.
EN	5	Enable input control. Active high and must be pulled up to enable the device.
VBST	6	Supply input for the high-side NFET gate drive circuit. Connect a 0.1 μ F capacitor between VBST and SW pins.

6 Specifications

6.1 Absolute Maximum Ratings⁽¹⁾

 $T_J = -40^{\circ}\text{C}$ to 150°C (unless otherwise noted)

		MIN	MAX	UNIT
Input voltage range	VIN, EN	-0.3	19	V
	VBST	-0.3	25	V
	VBST (10 ns transient)	-0.3	27.5	V
	VBST (vs SW)	-0.3	6.5	V
	VFB	-0.3	6.5	V
	SW	-2	19	V
	SW (10 ns transient)	-3.5	21	V
Operating junction temperature, T_J		-40	150	$^{\circ}\text{C}$
Storage temperature range, T_{stg}		-55	150	$^{\circ}\text{C}$

- (1) Stresses beyond those listed under absolute maximum ratings may cause permanent damage to the device. These are stress ratings only, and functional operation of the device at these or any other conditions beyond those indicated under recommended operating conditions is not implied. Exposure to absolute-maximum-rated conditions for extended periods may affect device reliability.

6.2 ESD Ratings

			VALUE	UNIT
$V_{\text{(ESD)}}$	Electrostatic discharge	Human body model (HBM), per ANSI/ESDA/JEDEC JS-001, all pins ⁽¹⁾	± 2000	V
		Charged device model (CDM), per JEDEC specification JESD22-C101, all pins ⁽²⁾	± 500	

- (1) JEDEC document JEP155 states that 500-V HBM allows safe manufacturing with a standard ESD control process.
 (2) JEDEC document JEP157 states that 250-V CDM allows safe manufacturing with a standard ESD control process.

6.3 Recommended Operating Conditions

 $T_J = -40^{\circ}\text{C}$ to 150°C (unless otherwise noted)

		MIN	MAX	UNIT	
V_{IN}	Supply input voltage range	4.5	17	V	
V_I	Input voltage range	VBST	-0.1	23	V
		VBST (10 ns transient)	-0.1	26	
		VBST(vs SW)	-0.1	6	
		EN	-0.1	17	
		VFB	-0.1	5.5	
		SW	-1.8	17	
		SW (10 ns transient)	-3.5	20	
T_A	Operating free-air temperature	-40	85	$^{\circ}\text{C}$	

6.4 Thermal Information

THERMAL METRIC ⁽¹⁾		TPS562200	TPS563200	UNITS
		DDC (SOT)	DDC (SOT)	
		(6 PINS)	(6 PINS)	
$R_{\theta\text{JA}}$	Junction-to-ambient thermal resistance	89.0	87.9	$^{\circ}\text{C}/\text{W}$
$R_{\theta\text{Jctop}}$	Junction-to-case (top) thermal resistance	44.5	42.2	
$R_{\theta\text{JB}}$	Junction-to-board thermal resistance	13.4	13.6	
ψ_{JT}	Junction-to-top characterization parameter	2.2	1.9	
ψ_{JB}	Junction-to-board characterization parameter	13.2	13.3	

- (1) For more information about traditional and new thermal metrics, see the *IC Package Thermal Metrics* application report, [SPRA953](#).

6.5 Electrical Characteristics

 $T_J = -40^{\circ}\text{C}$ to 150°C , $V_{IN} = 12\text{V}$ (unless otherwise noted)

PARAMETER		TEST CONDITIONS	MIN	TYP	MAX	UNIT	
SUPPLY CURRENT							
$I_{R(VIN)}$	Operating – non-switching supply current	V_{IN} current, $T_A = 25^{\circ}\text{C}$, $E_N = 5\text{V}$, $V_{FB} = 0.8\text{V}$	TPS562200	230	330	μA	
			TPS563200	190	290		
$I_{R(VINSDN)}$	Shutdown supply current	V_{IN} current, $T_A = 25^{\circ}\text{C}$, $E_N = 0\text{V}$		3	10	μA	
LOGIC THRESHOLD							
$V_{EN(H)}$	EN high-level input voltage	EN	1.6			V	
$V_{EN(L)}$	EN low-level input voltage	EN			0.6	V	
R_{EN}	EN pin resistance to GND	$V_{EN} = 12\text{V}$	225	450	900	k Ω	
V_{FB} VOLTAGE AND DISCHARGE RESISTANCE							
$V_{FB(TH)}$	V_{FB} threshold voltage	$T_A = 25^{\circ}\text{C}$, $V_O = 1.05\text{V}$, $I_O = 10\text{mA}$, Eco-mode™ operation		772		mV	
		$T_A = 25^{\circ}\text{C}$, $V_O = 1.05\text{V}$, continuous mode operation	758	765	772	mV	
$I_{R(VFB)}$	V_{FB} input current	$V_{FB} = 0.8\text{V}$, $T_A = 25^{\circ}\text{C}$		0	± 0.1	μA	
MOSFET							
$R_{DS(on)h}$	High side switch resistance	$T_A = 25^{\circ}\text{C}$, $V_{BST} - SW = 5.5\text{V}$	TPS562200		122	m Ω	
			TPS563200		68	m Ω	
$R_{DS(on)l}$	Low side switch resistance	$T_A = 25^{\circ}\text{C}$	TPS562200		72	m Ω	
			TPS563200		39	m Ω	
CURRENT LIMIT							
I_{oc1}	Current limit ⁽¹⁾	DC current, $V_{OUT} = 1.05\text{V}$, $L_{OUT} = 2.2\mu\text{F}$	TPS562200	2.5	3.2	4.3	A
		DC current, $V_{OUT} = 1.05\text{V}$, $L_{OUT} = 1.5\mu\text{F}$	TPS563200	3.5	4.2	5.3	A
THERMAL SHUTDOWN							
T_{SDN}	Thermal shutdown threshold ⁽¹⁾	Shutdown temperature		155		$^{\circ}\text{C}$	
		Hysteresis		35			
OUTPUT UNDERVOLTAGE AND OVERVOLTAGE PROTECTION							
V_{OVP}	Output OVP threshold	OVP Detect		125% x V_{fbth}			
V_{UVP}	Output Hiccup threshold	Hiccup detect		65% x V_{fbth}			
$t_{HiccupOn}$	Hiccup On Time	Relative to soft-start time		1		ms	
$t_{HiccupOff}$	Hiccup Off Time	Relative to soft-start time		7		ms	
UVLO							
UVLO	UVLO threshold	Wake up V_{IN} voltage		3.45	3.75	4.05	V
		Hysteresis V_{IN} voltage		0.13	0.32	0.55	

(1) Not production tested

6.6 Timing Requirements

			MIN	TYP	MAX	UNIT
ON-TIME TIMER CONTROL						
t_{ON}	On time	$V_{IN} = 12\text{V}$, $V_O = 1.05\text{V}$		150		ns
$t_{OFF(MIN)}$	Minimum off time	$T_A = 25^{\circ}\text{C}$, $V_{FB} = 0.5\text{V}$		260	310	ns
SOFT START						
t_{ss}	Soft-start time	Internal soft-start time, $T_A = 25^{\circ}\text{C}$	0.7	1	1.3	ms

6.7 Typical Characteristics TPS562200

$V_{IN} = 12\text{ V}$ (unless otherwise noted).

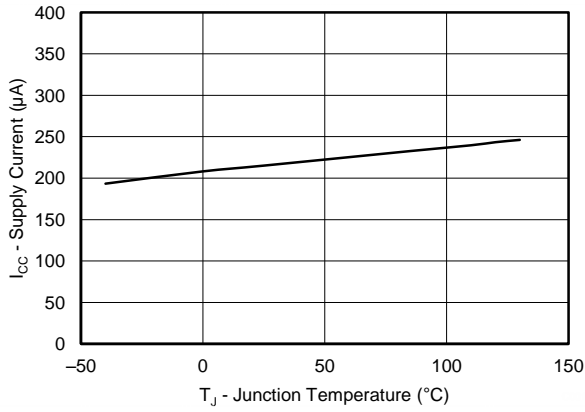

Figure 1. Supply Current vs Junction Temperature

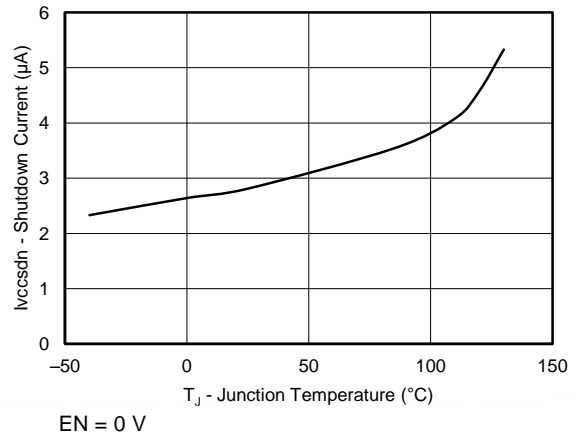

Figure 2. VIN Shutdown Current vs Junction Temperature

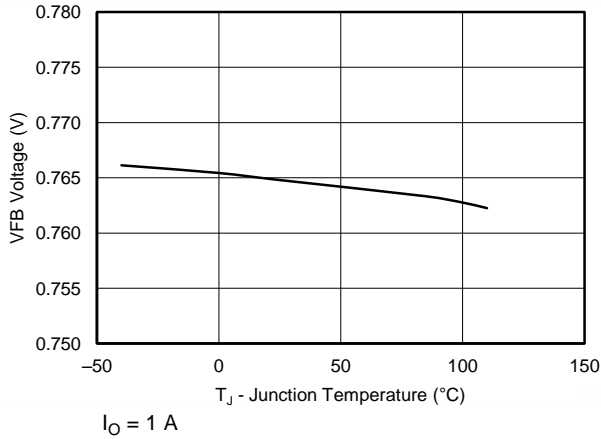

Figure 3. Vfb Voltage vs Junction Temperature

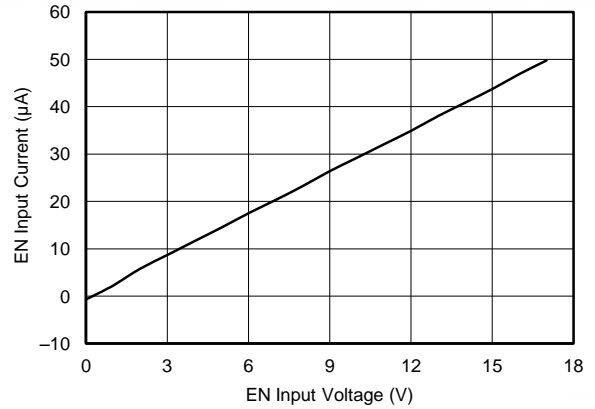

Figure 4. En Current vs En Voltage

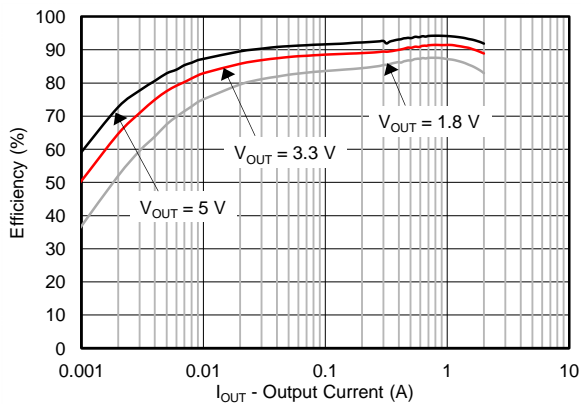

Figure 5. Efficiency vs Output Current

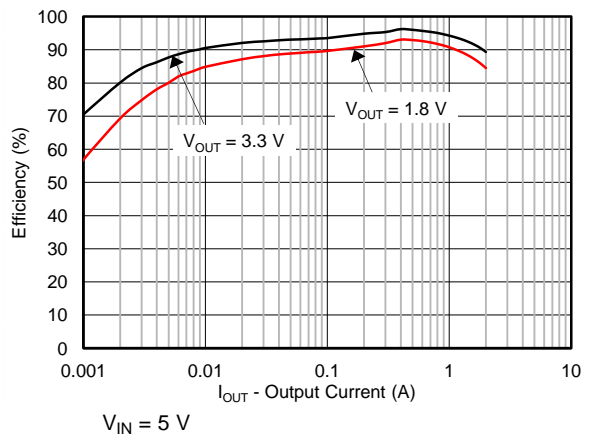

Figure 6. Efficiency vs Output Current

Typical Characteristics TPS562200 (continued)

$V_{IN} = 12\text{ V}$ (unless otherwise noted).

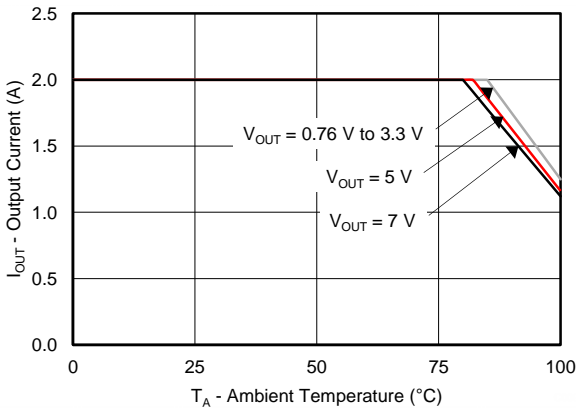

Figure 7. Output Current vs Ambient Temperature

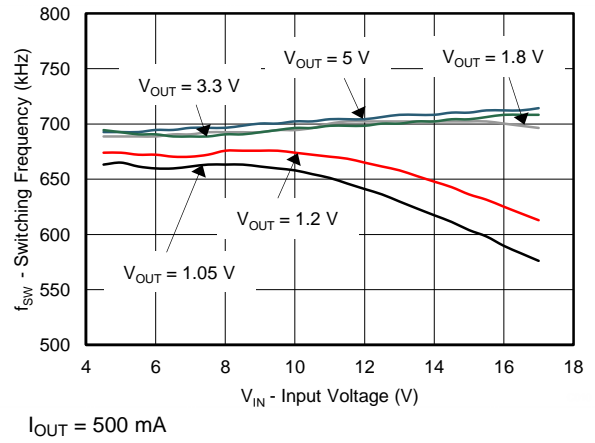

Figure 8. Switching Frequency vs Input Voltage

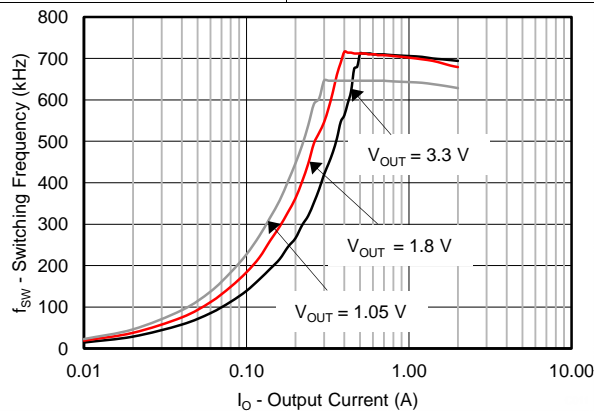
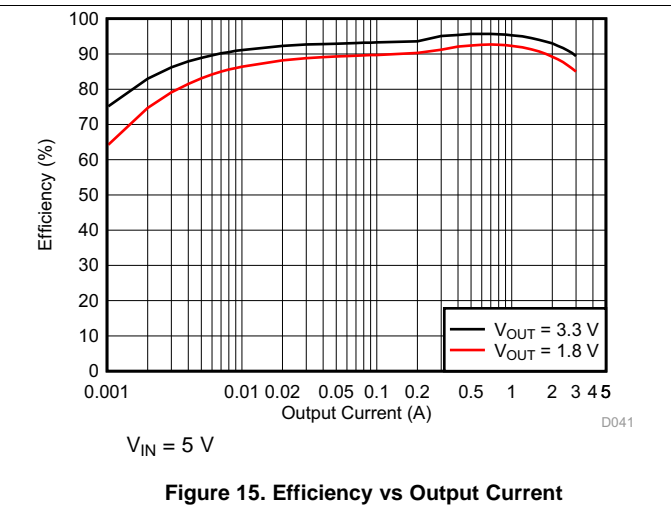
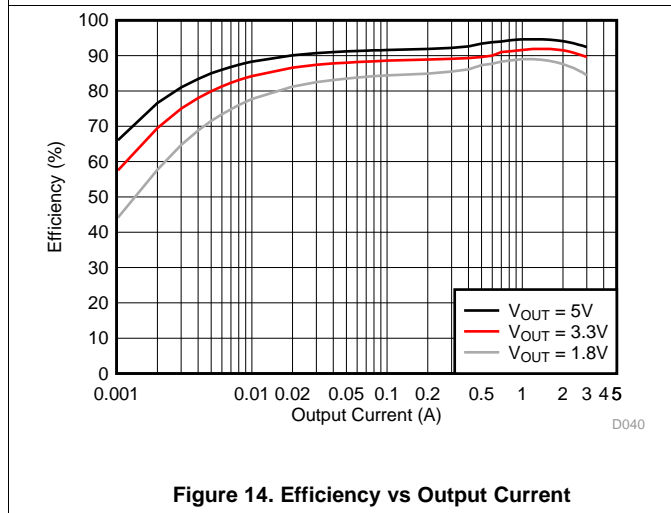
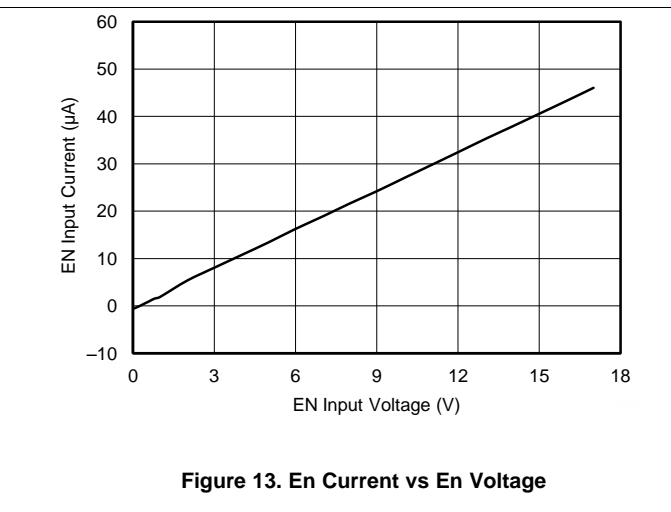
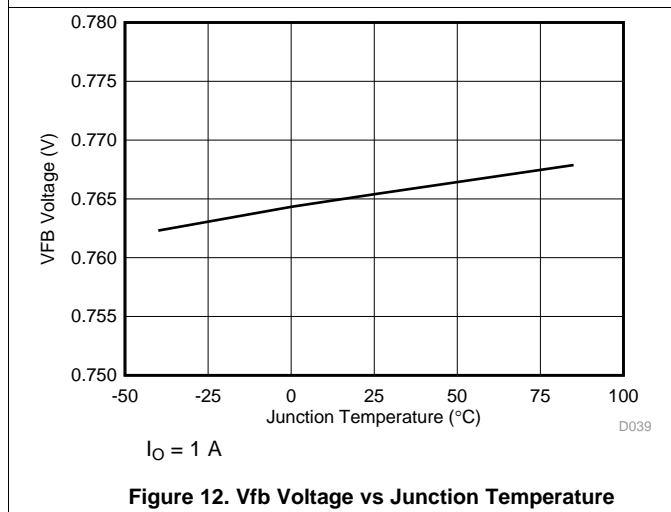
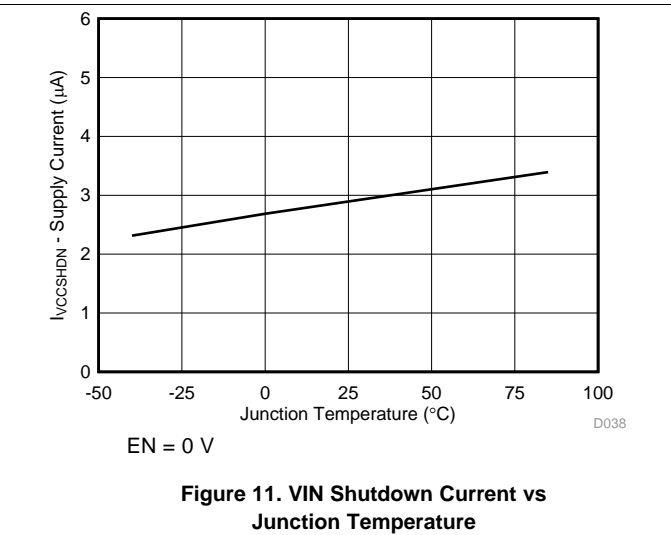
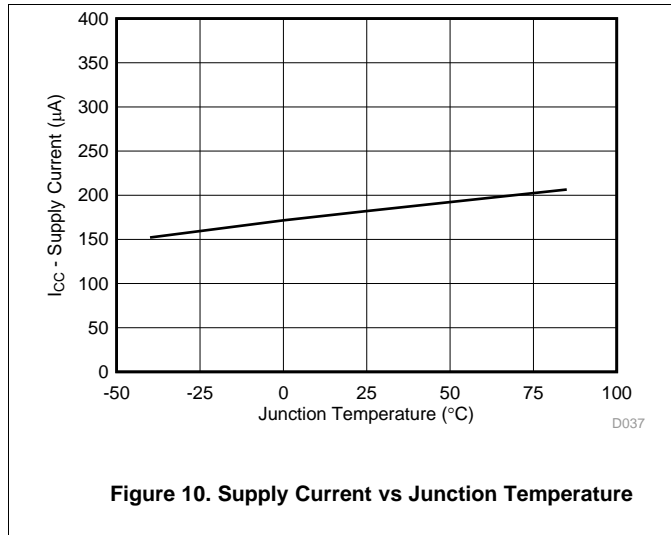

Figure 9. Switching Frequency vs Output Current

6.8 Typical Characteristics TPS563200

$V_{IN} = 12\text{ V}$ (unless otherwise noted).



Typical Characteristics TPS563200 (continued)

$V_{IN} = 12\text{ V}$ (unless otherwise noted).

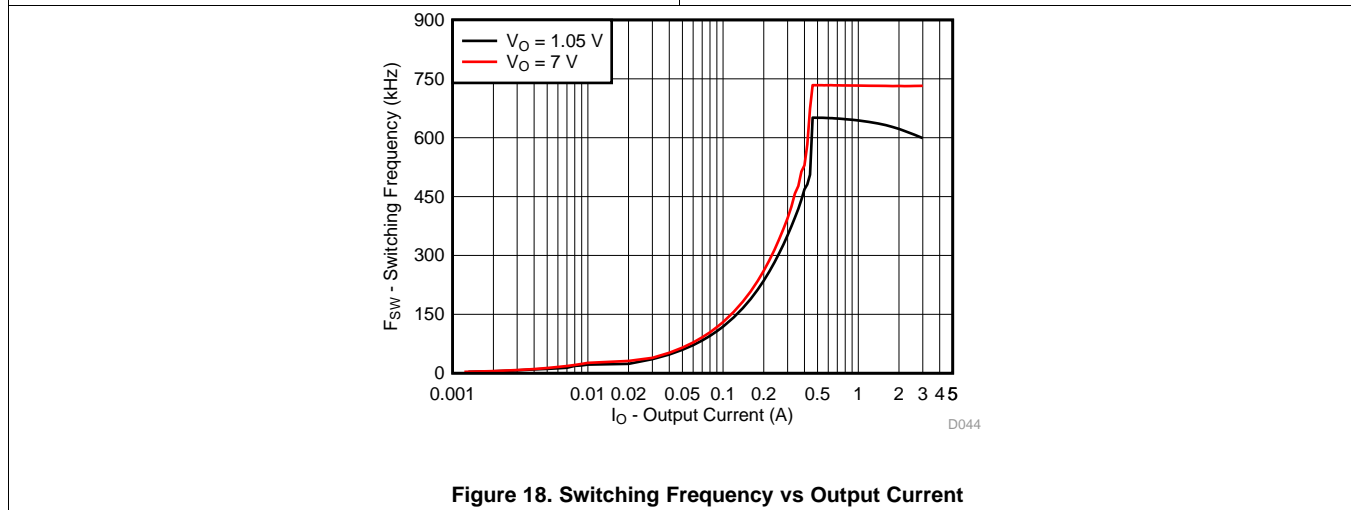
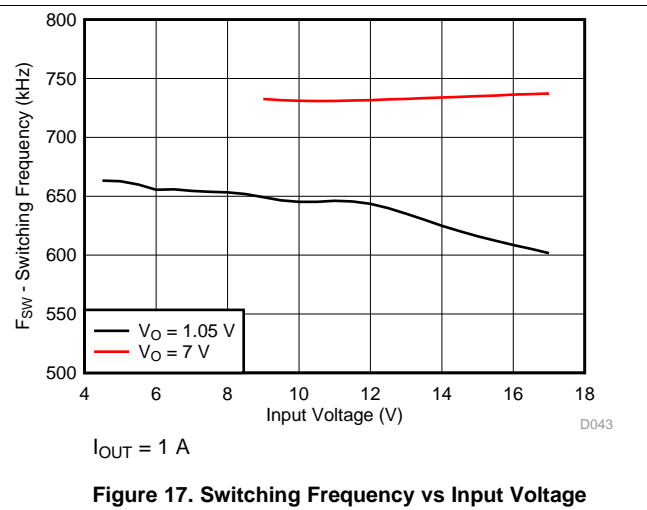
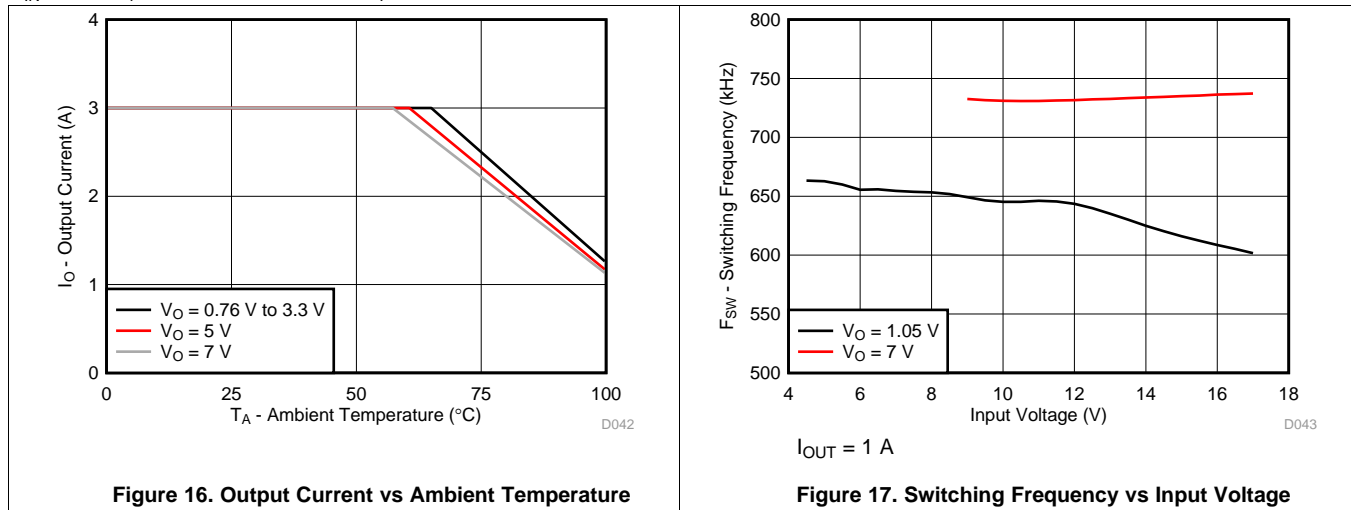

7 Detailed Description

7.1 Overview

The TPS562200 and TPS563200 are 2-A and 3-A synchronous step-down converters. The proprietary D-CAP2™ mode control supports low ESR output capacitors such as specialty polymer capacitors and multi-layer ceramic capacitors without complex external compensation circuits. The fast transient response of D-CAP2™ mode control can reduce the output capacitance required to meet a specific level of performance.

7.2 Functional Block Diagrams

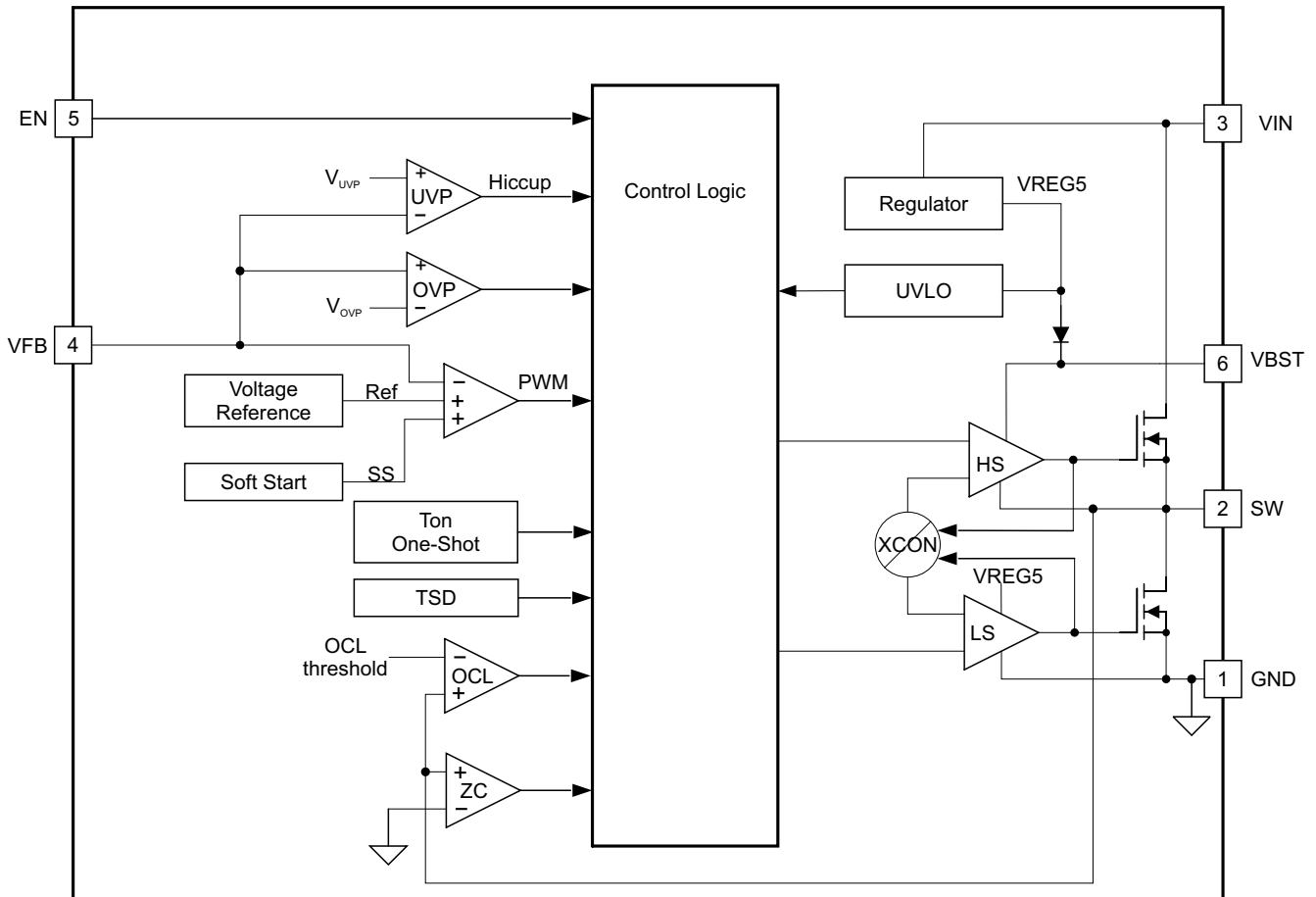

Copyright © 2016, Texas Instruments Incorporated

Figure 19. Functional Block Diagram: TPS562200 And TPS563200

7.3 Feature Description

7.3.1 The Adaptive On-Time Control And PWM Operation

The main control loop of the TPS562200 and TPS563200 are adaptive on-time pulse width modulation (PWM) controller that supports a proprietary D-CAP2™ mode control. The D-CAP2™ mode control combines adaptive on-time control with an internal compensation circuit for pseudo-fixed frequency and low external component count configuration with both low ESR and ceramic output capacitors. It is stable even with virtually no ripple at the output.

At the beginning of each cycle, the high-side MOSFET is turned on. This MOSFET is turned off after internal one shot timer expires. This one shot duration is set inversely proportional to the converter input voltage, V_{IN} , and proportional to the output voltage, V_O , to maintain a pseudo-fixed frequency over the input voltage range, hence it is called adaptive on-time control. The one-shot timer is reset and the high-side MOSFET is turned on again when the feedback voltage falls below the reference voltage. An internal ramp is added to reference voltage to simulate output ripple, eliminating the need for ESR induced output ripple from D-CAP2™ mode control.

7.3.2 Advanced Eco-Mode™ Control

The TPS562200 and TPS563200 are designed with Advanced Eco-mode™ to maintain high light load efficiency. As the output current decreases from heavy load condition, the inductor current is also reduced and eventually comes to point that its rippled valley touches zero level, which is the boundary between continuous conduction and discontinuous conduction modes. The rectifying MOSFET is turned off when the zero inductor current is detected. As the load current further decreases, the converter runs into discontinuous conduction mode. The on-time is kept almost the same as it was in the continuous conduction mode so that it takes longer time to discharge the output capacitor with smaller load current to the level of the reference voltage. This makes the switching frequency lower, proportional to the load current, and keeps the light load efficiency high. The transition point to the light load operation $I_{OUT(LL)}$ current can be calculated in [Equation 1](#).

$$I_{OUT(LL)} = \frac{1}{2 \times L \times f_{SW}} \times \frac{(V_{IN} - V_{OUT}) \times V_{OUT}}{V_{IN}} \quad (1)$$

7.3.3 Soft Start And Pre-Biased Soft Start

The TPS562200 and TPS563200 have an internal 1 ms soft-start. When the EN pin becomes high, the internal soft-start function begins ramping up the reference voltage to the PWM comparator. If the output capacitor is pre-biased at startup, the devices initiate switching and start ramping up only after the internal reference voltage becomes greater than the feedback voltage VFB. This scheme ensures that the converters ramp up smoothly into regulation point.

7.3.4 Current Protection

The output overcurrent limit (OCL) is implemented using a cycle-by-cycle valley detect control circuit. The switch current is monitored during the OFF state by measuring the low-side FET drain to source voltage. This voltage is proportional to the switch current. To improve accuracy, the voltage sensing is temperature compensated.

During the on time of the high-side FET switch, the switch current increases at a linear rate determined by V_{IN} , V_{OUT} , the on-time and the output inductor value. During the on time of the low-side FET switch, this current decreases linearly. The average value of the switch current is the load current I_{OUT} . If the monitored current is above the OCL level, the converter maintains low-side FET on and delays the creation of a new set pulse, even the voltage feedback loop requires one, until the current level becomes OCL level or lower. In subsequent switching cycles, the on-time is set to a fixed value and the current is monitored in the same manner. If the over current condition exists consecutive switching cycles, the internal OCL threshold is set to a lower level, reducing the available output current. When a switching cycle occurs where the switch current is not above the lower OCL threshold, the counter is reset and the OCL threshold is returned to the higher value.

There are some important considerations for this type of over-current protection. The load current is higher than the over-current threshold by one half of the peak-to-peak inductor ripple current. Also, when the current is being limited, the output voltage tends to fall as the demanded load current may be higher than the current available from the converter. This may cause the output voltage to fall. When the VFB voltage falls below the UVP threshold voltage, the UVP comparator detects it. Then, the device shuts down after the UVP delay time (typically 14 μ s) and re-start after the hiccup time (typically 12 ms).

Feature Description (continued)

When the overcurrent condition is removed, the output voltage returns to the regulated value.

7.3.5 Over Voltage Protection

TPS562200 and TPS563200 detect overvoltage condition by monitoring the feedback voltage (VFB). When the feedback voltage becomes higher than 125% of the target voltage, the OVP comparator output goes high and both the high-side MOSFET driver and the low-side MOSFET driver turn off. This function is non-latch operation.

7.3.6 UVLO Protection

Undervoltage lock out protection (UVLO) monitors the internal regulator voltage. When the voltage is lower than UVLO threshold voltage, the device is shut off. This protection is non-latching.

7.3.7 Thermal Shutdown

The device monitors the temperature of itself. If the temperature exceeds the threshold value (typically 155°C), the device is shut off. This is a non-latch protection.

7.4 Device Functional Modes

7.4.1 Normal Operation

When the input voltage is above the UVLO threshold and the EN voltage is above the enable threshold, the TPS562200 and TPS563200 can operate in their normal switching modes. Normal continuous conduction mode (CCM) occurs when the minimum switch current is above 0 A. In CCM, the TPS562200 and TPS563200 operate at a quasi-fixed frequency of 650 kHz.

7.4.2 Eco-Mode Operation

When the TPS562200 and TPS563200 are in the normal CCM operating mode and the switch current falls to 0 A, the TPS562200 and TPS563200 begin operating in pulse skipping eco-mode. Each switching cycle is followed by a period of energy saving sleep time. The sleep time ends when the VFB voltage falls below the eco-mode threshold voltage. As the output current decreases the perceived time between switching pulses increases.

7.4.3 Standby Operation

When the TPS562200 and TPS563200 are operating in either normal CCM or eco-mode, they may be placed in standby by asserting the EN pin low.

8 Application And Implementation

NOTE

Information in the following applications sections is not part of the TI component specification, and TI does not warrant its accuracy or completeness. TI's customers are responsible for determining suitability of components for their purposes. Customers should validate and test their design implementation to confirm system functionality.

8.1 Application Information

The TPS562200 and TPS563200 are typically used as step down converters, which convert a voltage from 4.5V - 17V to a lower voltage. Webench software is available to aid in the design and analysis of circuits

8.2 Typical Applications

8.2.1 Tps562200 4.5-V To 17-V Input, 1.05-V Output Converter

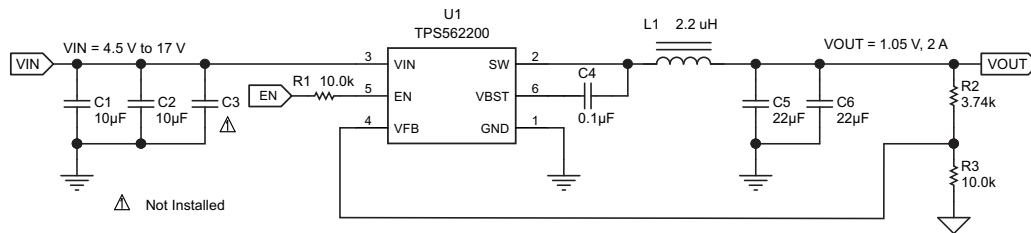

Copyright © 2016, Texas Instruments Incorporated

Figure 20. Tps562200 1.05v/2a Reference Design

8.2.1.1 Design Requirements

To begin the design process, the user must know a few application parameters:

Table 1. Design Parameters

PARAMETER	VALUE
Input voltage range	4.5 V to 17 V
Output voltage	1.05 V
Output current	2 A
Output voltage ripple	20 mVpp

8.2.1.2 Detailed Design Procedures

8.2.1.2.1 Custom Design with WEBENCH Tools

[Click here](#) to create a custom design using the TPS563200 device with the WEBENCH® Power Designer.

1. Start by entering your V_{IN} , V_{OUT} and I_{OUT} requirements.
2. Optimize your design for key parameters like efficiency, footprint and cost using the optimizer dial and compare this design with other possible solutions from Texas Instruments.
3. WEBENCH Power Designer provides you with a customized schematic along with a list of materials with real time pricing and component availability.
4. In most cases, you will also be able to:
 - Run electrical simulations to see important waveforms and circuit performance,
 - Run thermal simulations to understand the thermal performance of your board,
 - Export your customized schematic and layout into popular CAD formats,
 - Print PDF reports for the design, and share your design with colleagues.

5. Get more information about WEBENCH tools at www.ti.com/webench.

8.2.1.2.2 Output Voltage Resistors Selection

The output voltage is set with a resistor divider from the output node to the VFB pin. It is recommended to use 1% tolerance or better divider resistors. Start by using [Equation 2](#) to calculate V_{OUT} .

To improve efficiency at light loads consider using larger value resistors, too high of resistance will be more susceptible to noise and voltage errors from the VFB input current will be more noticeable.

$$V_{OUT} = 0.765 \times \left(1 + \frac{R2}{R3} \right) \quad (2)$$

8.2.1.2.3 Output Filter Selection

The LC filter used as the output filter has double pole at:

$$F_P = \frac{1}{2\pi\sqrt{L_{OUT} \times C_{OUT}}} \quad (3)$$

At low frequencies, the overall loop gain is set by the output set-point resistor divider network and the internal gain of the device. The low frequency phase is 180 degrees. At the output filter pole frequency, the gain rolls off at a –40 dB per decade rate and the phase drops rapidly. D-CAP2™ introduces a high frequency zero that reduces the gain roll off to –20 dB per decade and increases the phase to 90 degrees one decade above the zero frequency. The inductor and capacitor selected for the output filter must be selected so that the double pole of Equation 3 is located below the high frequency zero but close enough that the phase boost provided by the high frequency zero provides adequate phase margin for a stable circuit. To meet this requirement use the values recommended in Table 1.

Table 2. TPS562200 Recommended Component Values

Output Voltage (V)	R2 (kΩ)	R3 (kΩ)	L1(μH)			C5 + C6 (μF)
			MIN	TYP	MAX	
1	3.09	10.0	1.5	2.2	4.7	20 - 68
1.05	3.74	10.0	1.5	2.2	4.7	20 - 68
1.2	5.76	10.0	1.5	2.2	4.7	20 - 68
1.5	9.53	10.0	1.5	2.2	4.7	20 - 68
1.8	13.7	10.0	1.5	2.2	4.7	20 - 68
2.5	22.6	10.0	2.2	3.3	4.7	20 - 68
3.3	33.2	10.0	2.2	3.3	4.7	20 - 68
5	54.9	10.0	3.3	4.7	4.7	20 - 68
6.5	75	10.0	3.3	4.7	4.7	20 - 68

The inductor peak-to-peak ripple current, peak current and RMS current are calculated using Equation 4, Equation 5 and Equation 6. The inductor saturation current rating must be greater than the calculated peak current and the RMS or heating current rating must be greater than the calculated RMS current. Use 650 kHz for f_{SW} .

Use 650 kHz for f_{SW} . Make sure the chosen inductor is rated for the peak current of Equation 5 and the RMS current of Equation 6.

$$I_{P-P} = \frac{V_{OUT}}{V_{IN(MAX)}} \times \frac{V_{IN(MAX)} - V_{OUT}}{L_O \times f_{SW}} \quad (4)$$

$$I_{PEAK} = I_O + \frac{I_{P-P}}{2} \quad (5)$$

$$I_{LO(RMS)} = \sqrt{I_O^2 + \frac{1}{12} I_{P-P}^2} \quad (6)$$

For this design example, the calculated peak current is 2.34 A and the calculated RMS current is 2.01 A. The inductor used is a TDK CLF7045T-2R2N with a peak current rating of 5.5-A and an RMS current rating of 4.3-A

The capacitor value and ESR determines the amount of output voltage ripple. The device is intended for use with ceramic or other low ESR capacitors. Recommended values range from 20 μF to 68 μF. Use Equation 7 to determine the required RMS current rating for the output capacitor.

$$I_{CO(RMS)} = \frac{V_{OUT} \times (V_{IN} - V_{OUT})}{\sqrt{12} \times V_{IN} \times L_O \times f_{SW}} \quad (7)$$

For this design two TDK C3216X5R0J226M 22 μF output capacitors are used. The typical ESR is 2 mΩ each. The calculated RMS current is 0.286 A and each output capacitor is rated for 4 A.

8.2.1.2.4 Input Capacitor Selection

The device requires an input decoupling capacitor and a bulk capacitor is needed depending on the application. A ceramic capacitor over 10 μF is recommended for the decoupling capacitor. An additional 0.1 μF capacitor(C3) from pin 3 to ground is optional to provide additional high frequency filtering. The capacitor voltage rating needs to be greater than the maximum input voltage.

8.2.1.2.5 Bootstrap Capacitor Selection

A 0.1 μF ceramic capacitor must be connected between the VBST to SW pin for proper operation. It is recommended to use a ceramic capacitor.

8.2.1.3 Application Curves

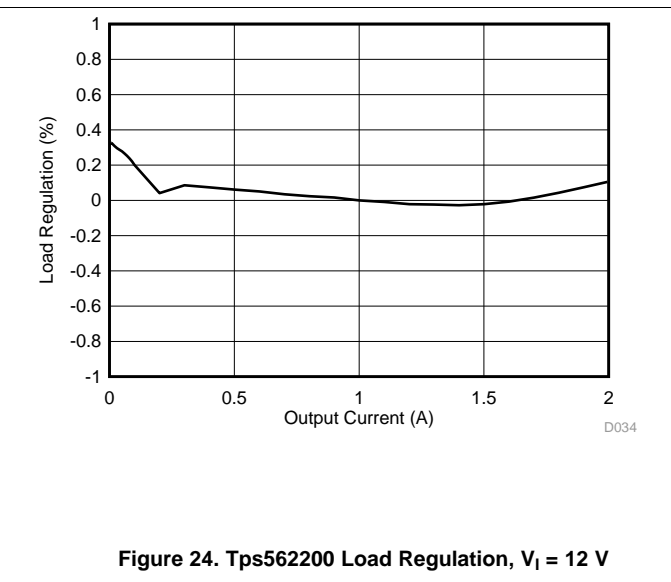
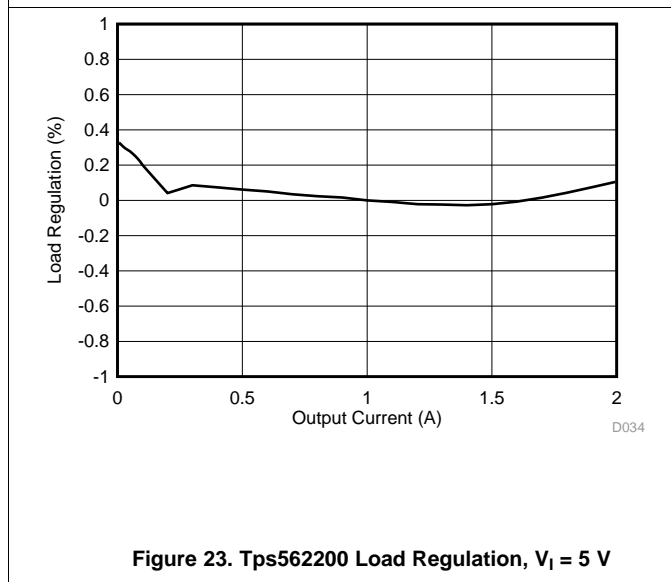
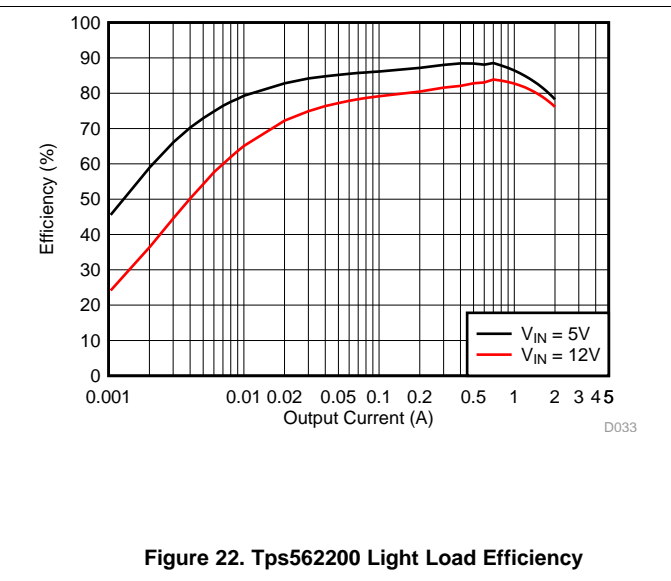
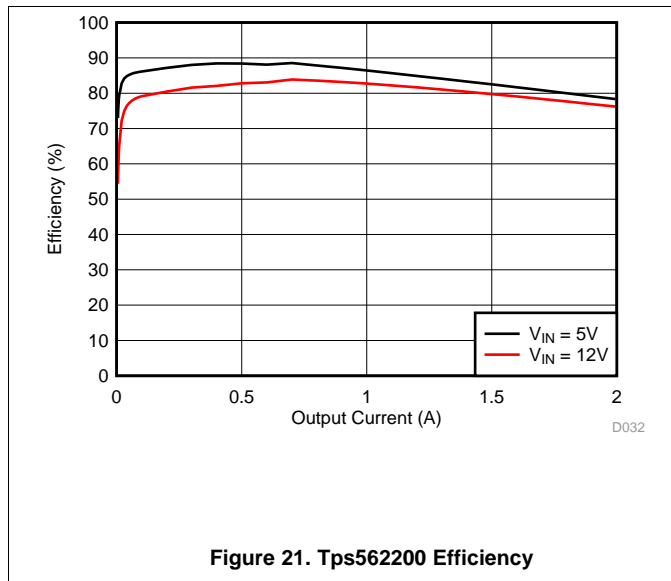

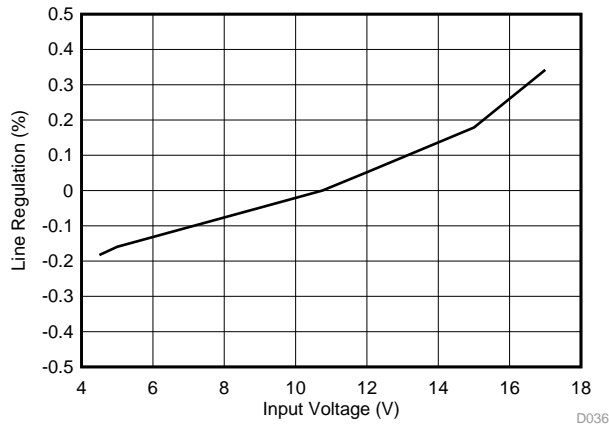

Figure 25. Tps562200 Line Regulation

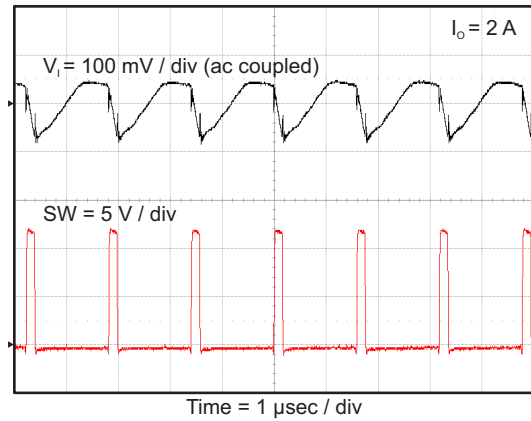

Figure 26. Tps562200 Input Voltage Ripple

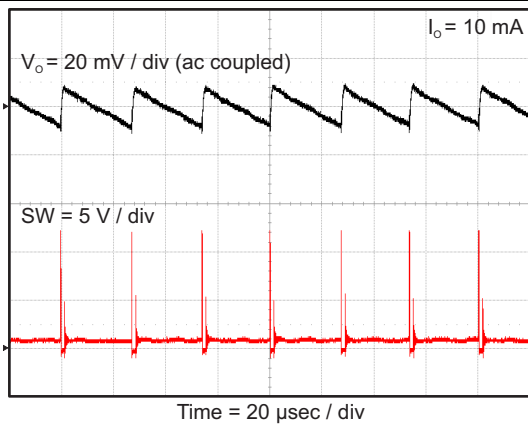

Figure 27. Tps562200 Output Voltage Ripple

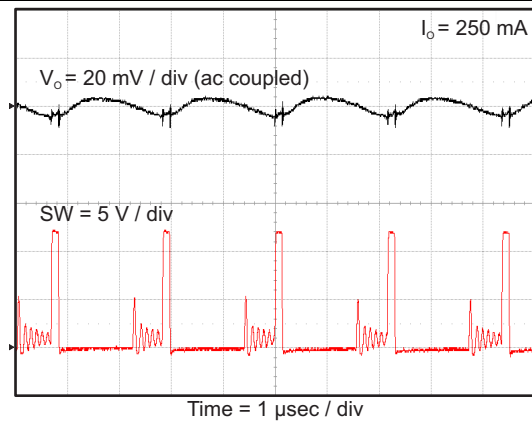

Figure 28. Tps562200 Output Voltage Ripple

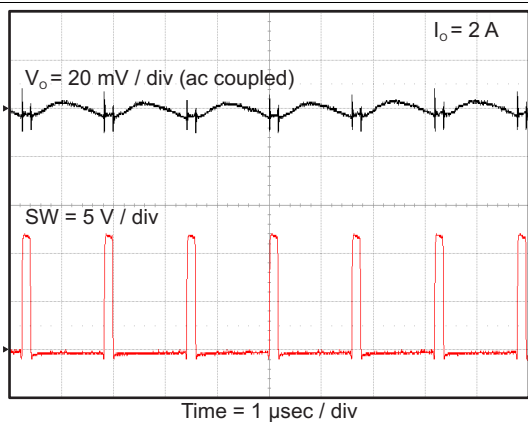

Figure 29. Tps562200 Output Voltage Ripple

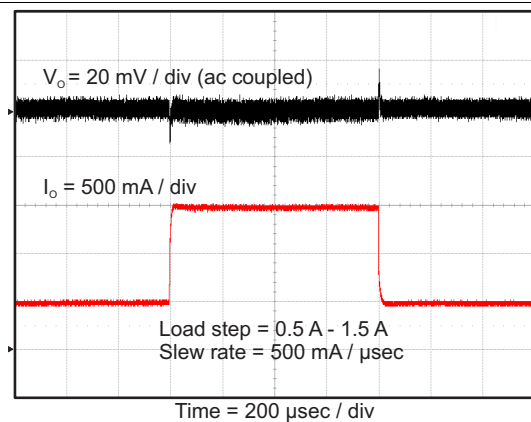

Figure 30. Tps562200 Transient Response

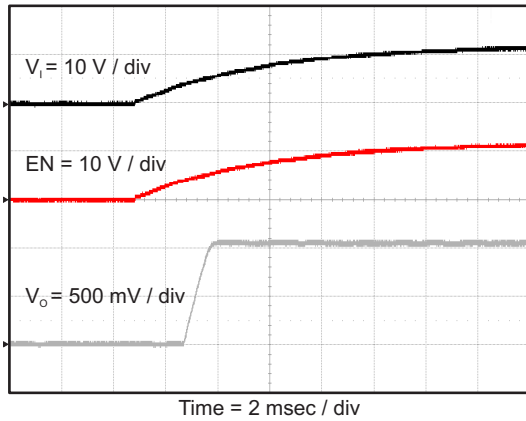

Figure 31. Tps562200 Start Up Relative To V₁

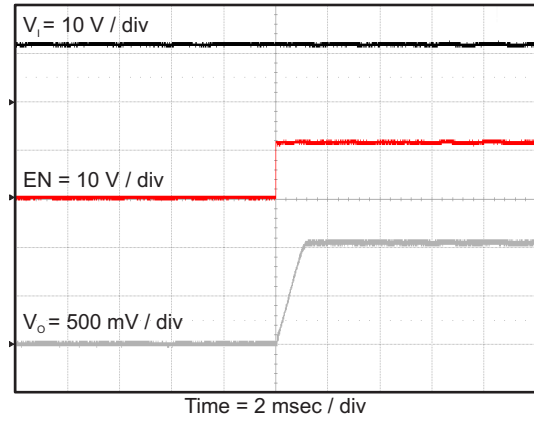

Figure 32. Tps562200 Start Up Relative To En

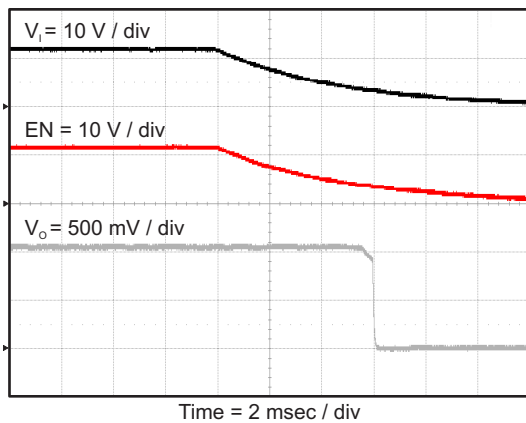

Figure 33. Tps562200 Shut Down Relative To V₁

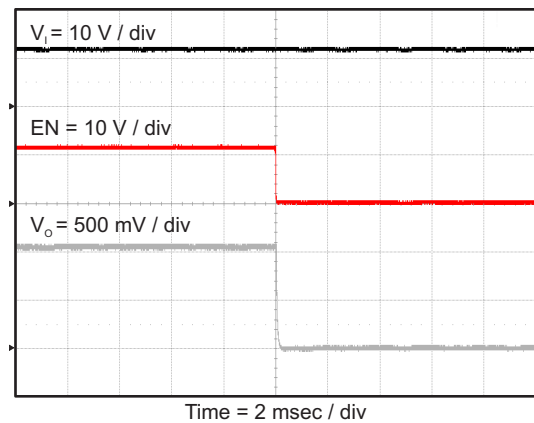
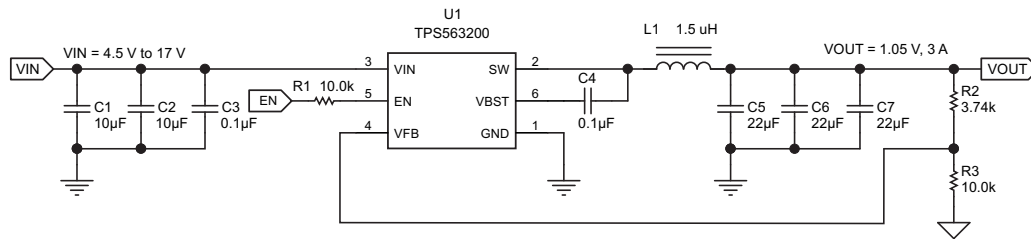

Figure 34. Tps562200 Shut Down Relative To En

8.2.2 Tps563200 4.5-V To 17-V Input, 1.05-V Output Converter



Copyright © 2016, Texas Instruments Incorporated

Figure 35. Tps563200 1.05v/3a Reference Design

8.2.2.1 Design Requirements

To begin the design process, the user must know a few application parameters:

Table 3. Design Parameters

PARAMETER	VALUE
Input voltage range	4.5 V to 17 V
Output voltage	1.05 V
Output current	3 A
Output voltage ripple	20 mVpp

8.2.2.2 Detailed Design Procedures

The detailed design procedure for TPS563200 is the same as for TPS562200 except for inductor selection.

8.2.2.2.1 Output Filter Selection

Table 4. Tps563200 Recommended Component Values

Output Voltage (V)	R2 (kΩ)	R3 (kΩ)	L1 (µH)			C5 + C6 + C7 (µF)
			MIN	TYP	MAX	
1	3.09	10.0	1.0	1.5	4.7	20 - 68
1.05	3.74	10.0	1.0	1.5	4.7	20 - 68
1.2	5.76	10.0	1.0	1.5	4.7	20 - 68
1.5	9.53	10.0	1.0	1.5	4.7	20 - 68
1.8	13.7	10.0	1.5	2.2	4.7	20 - 68
2.5	22.6	10.0	1.5	2.2	4.7	20 - 68
3.3	33.2	10.0	1.5	2.2	4.7	20 - 68
5	54.9	10.0	2.2	3.3	4.7	20 - 68
6.5	75	10.0	2.2	3.3	4.7	20 - 68

The inductor peak-to-peak ripple current, peak current and RMS current are calculated using Equation 8, Equation 9 and Equation 10. The inductor saturation current rating must be greater than the calculated peak current and the RMS or heating current rating must be greater than the calculated RMS current. Use 650 kHz for f_{sw} .

Use 650 kHz for f_{sw} . Make sure the chosen inductor is rated for the peak current of Equation 9 and the RMS current of Equation 10.

$$I_{P-P} = \frac{V_{OUT}}{V_{IN(MAX)}} \times \frac{V_{IN(MAX)} - V_{OUT}}{L_O \times f_{SW}} \tag{8}$$

$$I_{PEAK} = I_O + \frac{I_{P-P}}{2} \tag{9}$$

$$I_{LO(RMS)} = \sqrt{I_O^2 + \frac{1}{12} I_{P-P}^2} \tag{10}$$

For this design example, the calculated peak current is 3.505 A and the calculated RMS current is 3.014 A. The inductor used is a TDK CLF7045T-1R5N with a peak current rating of 7.3-A and an RMS current rating of 4.9-A.

The capacitor value and ESR determines the amount of output voltage ripple. The TPS563209 is intended for use with ceramic or other low ESR capacitors. Recommended values range from 20µF to 68µF. Use Equation 6 to determine the required RMS current rating for the output capacitor. For this design three TDK C3216X5R0J226M 22µF output capacitors are used. The typical ESR is 2 mΩ each. The calculated RMS current is 0.292A and each output capacitor is rated for 4A.

8.2.2.3 Application Curves

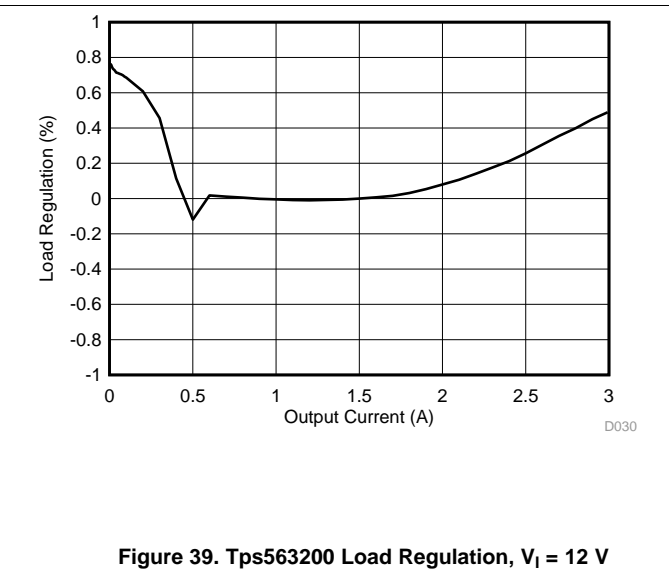
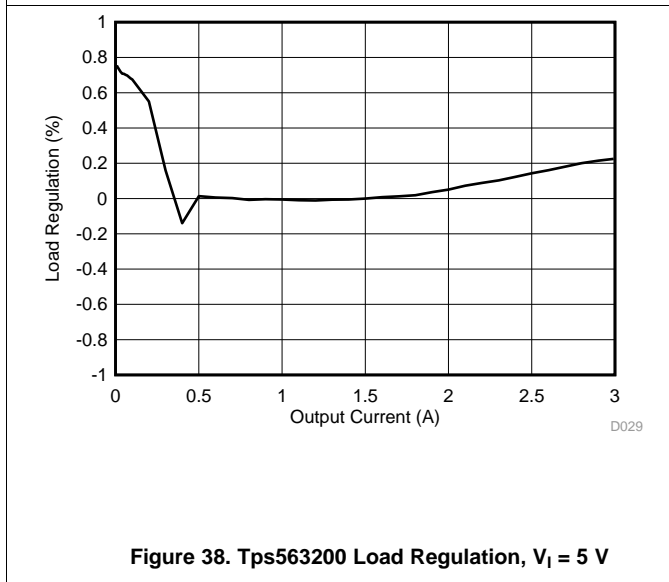
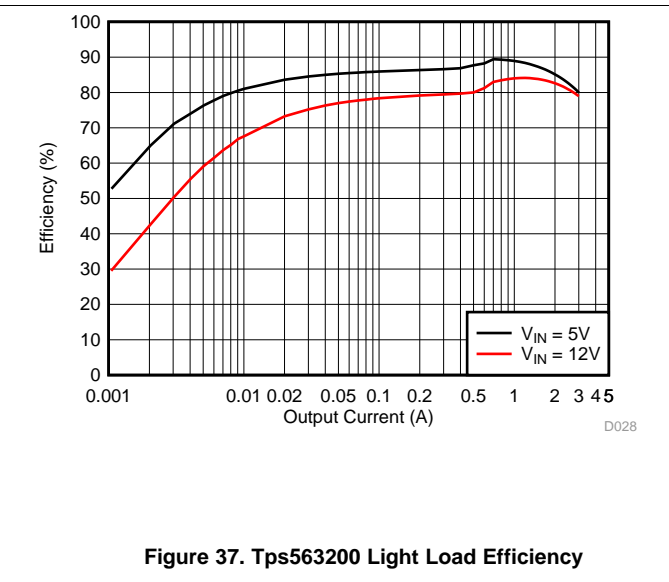
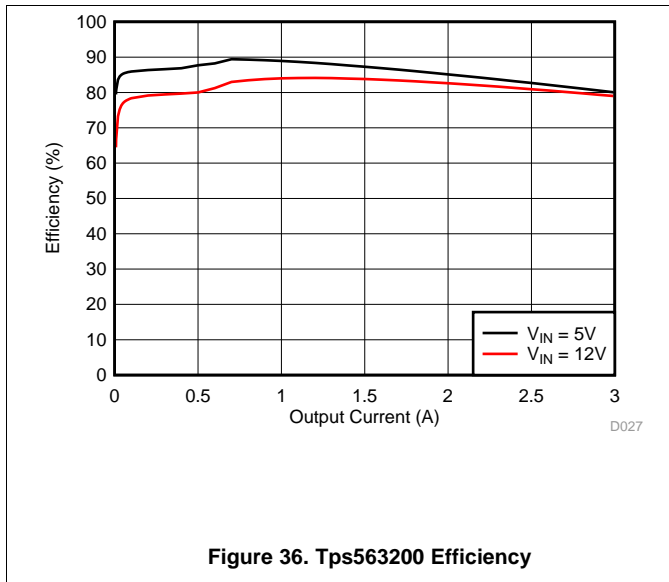

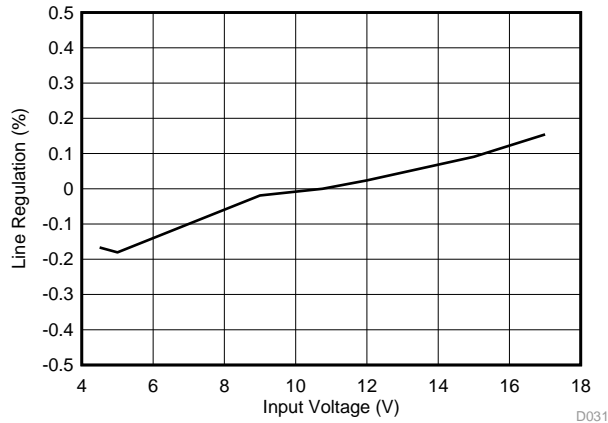

Figure 40. Tps563200 Line Regulation

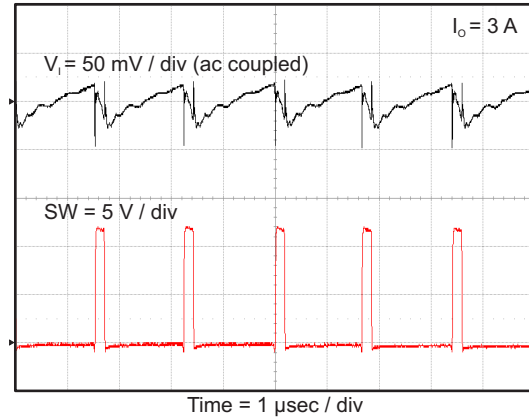

Figure 41. Tps563200 Input Voltage Ripple

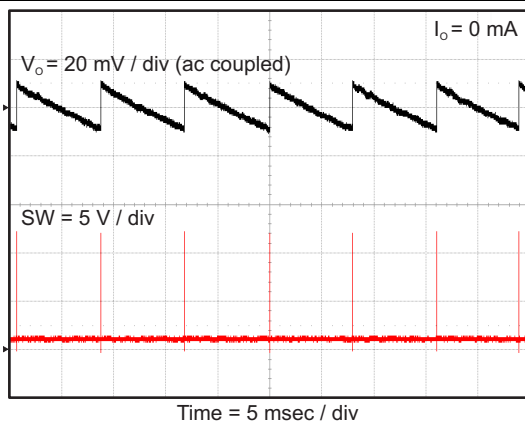

Figure 42. Tps563200 Output Voltage Ripple

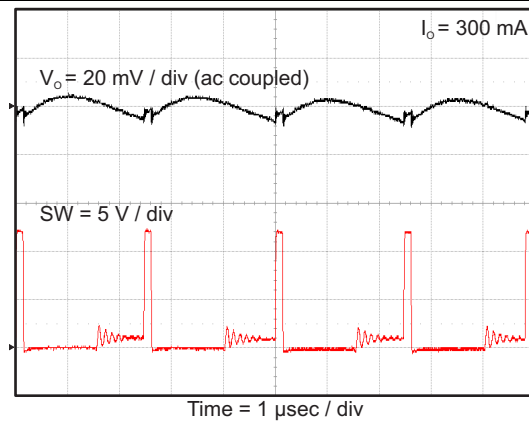

Figure 43. Tps563200 Output Voltage Ripple

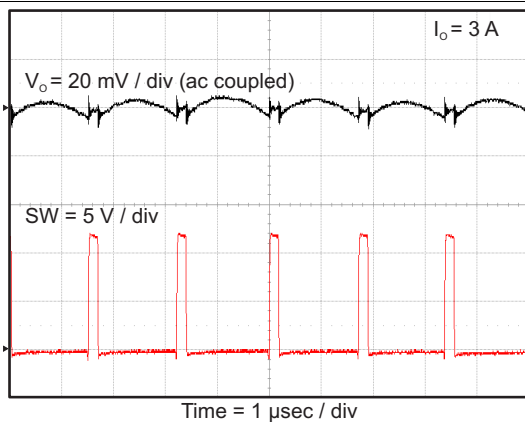

Figure 44. Tps563200 Output Voltage Ripple

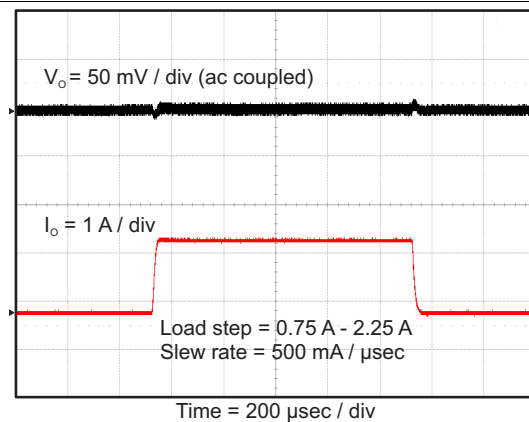

Figure 45. Tps563200 Transient Response

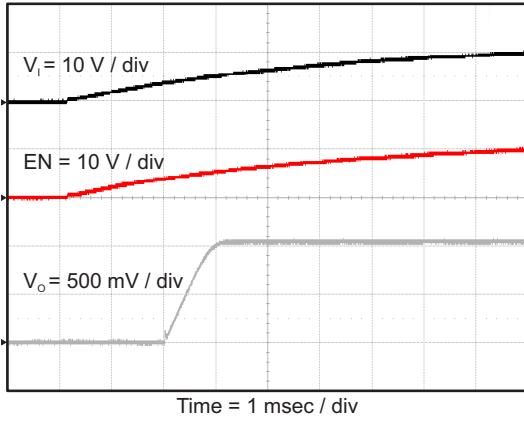

Figure 46. Tps563200 Start Up Relative To V_I

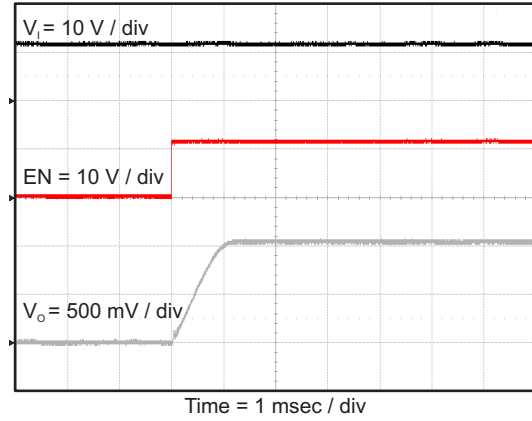

Figure 47. Tps563200 Start Up Relative To En

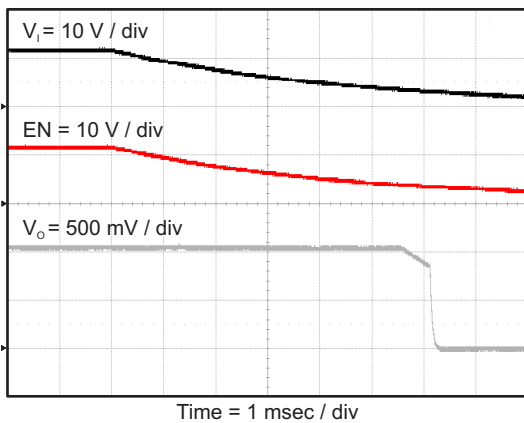

Figure 48. Tps563200 Shut Down Relative To V_I

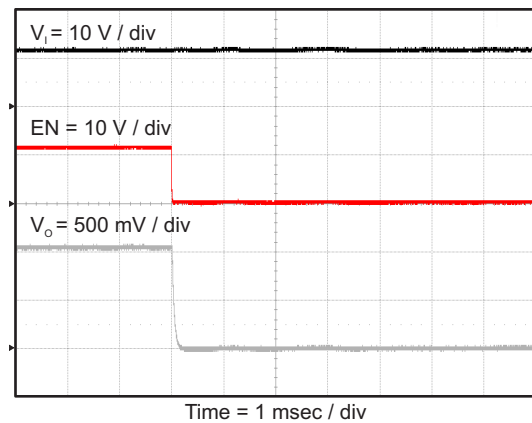

Figure 49. Tps563200 Shut Down Relative To En

9 Power Supply Recommendations

The TPS562200 and TPS563200 are designed to operate from input supply voltage in the range of 4.5V to 17V. Buck converters require the input voltage to be higher than the output voltage for proper operation. The maximum recommended operating duty cycle is 65%. Using that criteria, the minimum recommended input voltage is $V_O / 0.65$.

10 Layout

10.1 Layout Guidelines

1. VIN and GND traces should be as wide as possible to reduce trace impedance. The wide areas are also of advantage from the view point of heat dissipation.
2. The input capacitor and output capacitor should be placed as close to the device as possible to minimize trace impedance.
3. Provide sufficient vias for the input capacitor and output capacitor.
4. Keep the SW trace as physically short and wide as practical to minimize radiated emissions.
5. Do not allow switching current to flow under the device.
6. A separate VOUT path should be connected to the upper feedback resistor
7. Make a Kelvin connection to the GND pin for the feedback path.
8. Voltage feedback loop should be placed away from the high-voltage switching trace, and preferably has ground shield.
9. The trace of the VFB node should be as small as possible to avoid noise coupling.
10. The GND trace between the output capacitor and the GND pin should be as wide as possible to minimize its trace impedance.

10.2 Layout Example

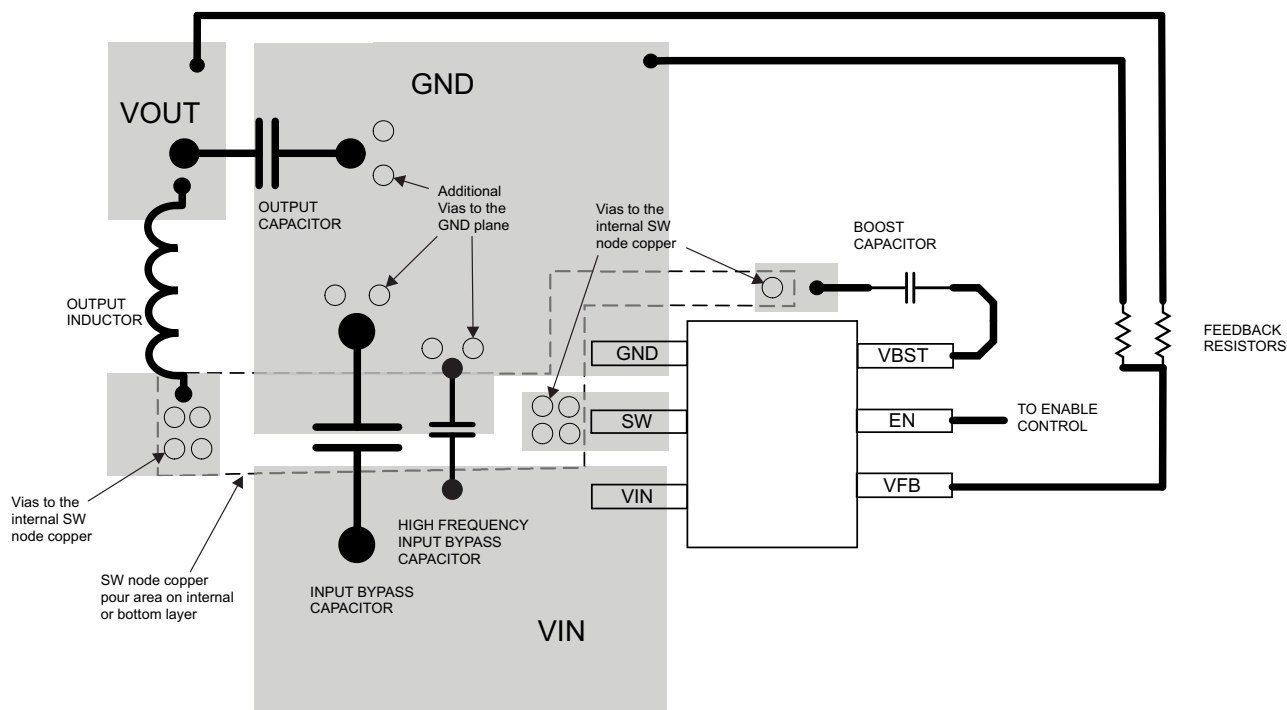

Figure 50. Typical Layout

11 Device And Documentation Support

11.1 Custom Design with WEBENCH Tools

[Click here](#) to create a custom design using the TPS563200 device with the WEBENCH® Power Designer.

1. Start by entering your V_{IN} , V_{OUT} and I_{OUT} requirements.
2. Optimize your design for key parameters like efficiency, footprint and cost using the optimizer dial and compare this design with other possible solutions from Texas Instruments.
3. WEBENCH Power Designer provides you with a customized schematic along with a list of materials with real time pricing and component availability.
4. In most cases, you will also be able to:
 - Run electrical simulations to see important waveforms and circuit performance,
 - Run thermal simulations to understand the thermal performance of your board,
 - Export your customized schematic and layout into popular CAD formats,
 - Print PDF reports for the design, and share your design with colleagues.
5. Get more information about WEBENCH tools at www.ti.com/webench.

11.2 Receiving Notification of Documentation Updates

To receive notification of documentation updates, navigate to the device product folder on ti.com. In the upper right corner, click on *Alert me* to register and receive a weekly digest of any product information that has changed. For change details, review the revision history included in any revised document.

11.3 Related Links

The table below lists quick access links. Categories include technical documents, support and community resources, tools and software, and quick access to sample or buy.

Table 5. Related Links

PARTS	PRODUCT FOLDER	SAMPLE & BUY	TECHNICAL DOCUMENTS	TOOLS & SOFTWARE	SUPPORT & COMMUNITY
TPS562200	Click here	Click here	Click here	Click here	Click here
TPS563200	Click here	Click here	Click here	Click here	Click here

11.4 Receiving Notification of Documentation Updates

To receive notification of documentation updates — go to the product folder for your device on ti.com. In the upper right-hand corner, click the *Alert me* button to register and receive a weekly digest of product information that has changed (if any). For change details, check the revision history of any revised document.

11.5 Community Resources

The following links connect to TI community resources. Linked contents are provided "AS IS" by the respective contributors. They do not constitute TI specifications and do not necessarily reflect TI's views; see TI's [Terms of Use](#).

TI E2E™ Online Community *TI's Engineer-to-Engineer (E2E) Community*. Created to foster collaboration among engineers. At e2e.ti.com, you can ask questions, share knowledge, explore ideas and help solve problems with fellow engineers.

Design Support *TI's Design Support* Quickly find helpful E2E forums along with design support tools and contact information for technical support.

11.6 Trademarks

D-CAP2, Eco-mode, E2E are trademarks of Texas Instruments.
 WEBENCH is a registered trademark of Texas Instruments.
 Blu-ray Disc is a trademark of Blu-ray Disc Association.

11.7 Electrostatic Discharge Caution



These devices have limited built-in ESD protection. The leads should be shorted together or the device placed in conductive foam during storage or handling to prevent electrostatic damage to the MOS gates.

11.8 Glossary

[SLYZ022](#) — *TI Glossary*.

This glossary lists and explains terms, acronyms, and definitions.

12 Mechanical, Packaging, And Orderable Information

The following pages include mechanical, packaging, and orderable information. This information is the most current data available for the designated devices. This data is subject to change without notice and revision of this document. For browser-based versions of this data sheet, refer to the left-hand navigation.

PACKAGING INFORMATION

Orderable Device	Status (1)	Package Type	Package Drawing	Pins	Package Qty	Eco Plan (2)	Lead/Ball Finish (6)	MSL Peak Temp (3)	Op Temp (°C)	Device Marking (4/5)	Samples
TPS562200DDCR	ACTIVE	SOT-23-THIN	DDC	6	3000	Green (RoHS & no Sb/Br)	CU SN	Level-1-260C-UNLIM	-40 to 125	200	Samples
TPS562200DDCT	ACTIVE	SOT-23-THIN	DDC	6	250	Green (RoHS & no Sb/Br)	CU SN	Level-1-260C-UNLIM	-40 to 125	200	Samples
TPS563200DDCR	ACTIVE	SOT-23-THIN	DDC	6	3000	Green (RoHS & no Sb/Br)	CU SN	Level-1-260C-UNLIM	-40 to 125	320	Samples
TPS563200DDCT	ACTIVE	SOT-23-THIN	DDC	6	250	Green (RoHS & no Sb/Br)	CU SN	Level-1-260C-UNLIM	-40 to 125	320	Samples

(1) The marketing status values are defined as follows:

ACTIVE: Product device recommended for new designs.

LIFEBUY: TI has announced that the device will be discontinued, and a lifetime-buy period is in effect.

NRND: Not recommended for new designs. Device is in production to support existing customers, but TI does not recommend using this part in a new design.

PREVIEW: Device has been announced but is not in production. Samples may or may not be available.

OBSOLETE: TI has discontinued the production of the device.

(2) **RoHS:** TI defines "RoHS" to mean semiconductor products that are compliant with the current EU RoHS requirements for all 10 RoHS substances, including the requirement that RoHS substance do not exceed 0.1% by weight in homogeneous materials. Where designed to be soldered at high temperatures, "RoHS" products are suitable for use in specified lead-free processes. TI may reference these types of products as "Pb-Free".

RoHS Exempt: TI defines "RoHS Exempt" to mean products that contain lead but are compliant with EU RoHS pursuant to a specific EU RoHS exemption.

Green: TI defines "Green" to mean the content of Chlorine (Cl) and Bromine (Br) based flame retardants meet JS709B low halogen requirements of <=1000ppm threshold. Antimony trioxide based flame retardants must also meet the <=1000ppm threshold requirement.

(3) MSL, Peak Temp. - The Moisture Sensitivity Level rating according to the JEDEC industry standard classifications, and peak solder temperature.

(4) There may be additional marking, which relates to the logo, the lot trace code information, or the environmental category on the device.

(5) Multiple Device Markings will be inside parentheses. Only one Device Marking contained in parentheses and separated by a "-" will appear on a device. If a line is indented then it is a continuation of the previous line and the two combined represent the entire Device Marking for that device.

(6) Lead/Ball Finish - Orderable Devices may have multiple material finish options. Finish options are separated by a vertical ruled line. Lead/Ball Finish values may wrap to two lines if the finish value exceeds the maximum column width.

Important Information and Disclaimer: The information provided on this page represents TI's knowledge and belief as of the date that it is provided. TI bases its knowledge and belief on information provided by third parties, and makes no representation or warranty as to the accuracy of such information. Efforts are underway to better integrate information from third parties. TI has taken and

continues to take reasonable steps to provide representative and accurate information but may not have conducted destructive testing or chemical analysis on incoming materials and chemicals. TI and TI suppliers consider certain information to be proprietary, and thus CAS numbers and other limited information may not be available for release.

In no event shall TI's liability arising out of such information exceed the total purchase price of the TI part(s) at issue in this document sold by TI to Customer on an annual basis.

TAPE AND REEL INFORMATION

QUADRANT ASSIGNMENTS FOR PIN 1 ORIENTATION IN TAPE

*All dimensions are nominal

Device	Package Type	Package Drawing	Pins	SPQ	Reel Diameter (mm)	Reel Width W1 (mm)	A0 (mm)	B0 (mm)	K0 (mm)	P1 (mm)	W (mm)	Pin1 Quadrant
TPS562200DDCR	SOT-23-THIN	DDC	6	3000	180.0	9.5	3.17	3.1	1.1	4.0	8.0	Q3
TPS562200DDCT	SOT-23-THIN	DDC	6	250	180.0	9.5	3.17	3.1	1.1	4.0	8.0	Q3
TPS563200DDCR	SOT-23-THIN	DDC	6	3000	180.0	9.5	3.17	3.1	1.1	4.0	8.0	Q3
TPS563200DDCT	SOT-23-THIN	DDC	6	250	180.0	9.5	3.17	3.1	1.1	4.0	8.0	Q3

TAPE AND REEL BOX DIMENSIONS

*All dimensions are nominal

Device	Package Type	Package Drawing	Pins	SPQ	Length (mm)	Width (mm)	Height (mm)
TPS562200DDCR	SOT-23-THIN	DDC	6	3000	184.0	184.0	19.0
TPS562200DDCT	SOT-23-THIN	DDC	6	250	184.0	184.0	19.0
TPS563200DDCR	SOT-23-THIN	DDC	6	3000	184.0	184.0	19.0
TPS563200DDCT	SOT-23-THIN	DDC	6	250	184.0	184.0	19.0

DDC (R-PDSO-G6)

PLASTIC SMALL-OUTLINE

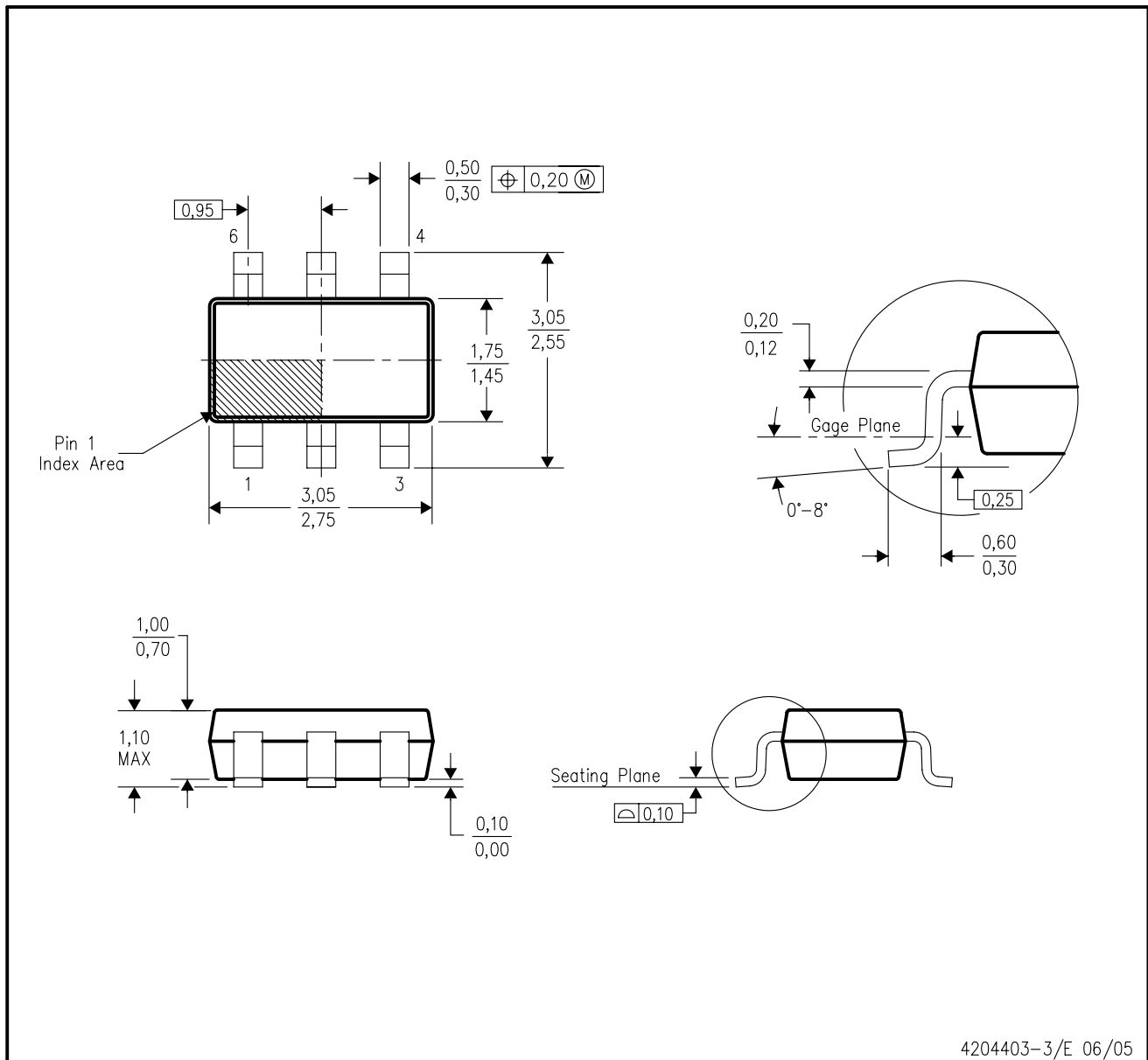

- NOTES:
- All linear dimensions are in millimeters.
 - This drawing is subject to change without notice.
 - Body dimensions do not include mold flash or protrusion.
 - Falls within JEDEC MO-193 variation AA (6 pin).

IMPORTANT NOTICE

Texas Instruments Incorporated (TI) reserves the right to make corrections, enhancements, improvements and other changes to its semiconductor products and services per JESD46, latest issue, and to discontinue any product or service per JESD48, latest issue. Buyers should obtain the latest relevant information before placing orders and should verify that such information is current and complete.

TI's published terms of sale for semiconductor products (<http://www.ti.com/sc/docs/stdterms.htm>) apply to the sale of packaged integrated circuit products that TI has qualified and released to market. Additional terms may apply to the use or sale of other types of TI products and services.

Reproduction of significant portions of TI information in TI data sheets is permissible only if reproduction is without alteration and is accompanied by all associated warranties, conditions, limitations, and notices. TI is not responsible or liable for such reproduced documentation. Information of third parties may be subject to additional restrictions. Resale of TI products or services with statements different from or beyond the parameters stated by TI for that product or service voids all express and any implied warranties for the associated TI product or service and is an unfair and deceptive business practice. TI is not responsible or liable for any such statements.

Buyers and others who are developing systems that incorporate TI products (collectively, "Designers") understand and agree that Designers remain responsible for using their independent analysis, evaluation and judgment in designing their applications and that Designers have full and exclusive responsibility to assure the safety of Designers' applications and compliance of their applications (and of all TI products used in or for Designers' applications) with all applicable regulations, laws and other applicable requirements. Designer represents that, with respect to their applications, Designer has all the necessary expertise to create and implement safeguards that (1) anticipate dangerous consequences of failures, (2) monitor failures and their consequences, and (3) lessen the likelihood of failures that might cause harm and take appropriate actions. Designer agrees that prior to using or distributing any applications that include TI products, Designer will thoroughly test such applications and the functionality of such TI products as used in such applications.

TI's provision of technical, application or other design advice, quality characterization, reliability data or other services or information, including, but not limited to, reference designs and materials relating to evaluation modules, (collectively, "TI Resources") are intended to assist designers who are developing applications that incorporate TI products; by downloading, accessing or using TI Resources in any way, Designer (individually or, if Designer is acting on behalf of a company, Designer's company) agrees to use any particular TI Resource solely for this purpose and subject to the terms of this Notice.

TI's provision of TI Resources does not expand or otherwise alter TI's applicable published warranties or warranty disclaimers for TI products, and no additional obligations or liabilities arise from TI providing such TI Resources. TI reserves the right to make corrections, enhancements, improvements and other changes to its TI Resources. TI has not conducted any testing other than that specifically described in the published documentation for a particular TI Resource.

Designer is authorized to use, copy and modify any individual TI Resource only in connection with the development of applications that include the TI product(s) identified in such TI Resource. NO OTHER LICENSE, EXPRESS OR IMPLIED, BY ESTOPPEL OR OTHERWISE TO ANY OTHER TI INTELLECTUAL PROPERTY RIGHT, AND NO LICENSE TO ANY TECHNOLOGY OR INTELLECTUAL PROPERTY RIGHT OF TI OR ANY THIRD PARTY IS GRANTED HEREIN, including but not limited to any patent right, copyright, mask work right, or other intellectual property right relating to any combination, machine, or process in which TI products or services are used. Information regarding or referencing third-party products or services does not constitute a license to use such products or services, or a warranty or endorsement thereof. Use of TI Resources may require a license from a third party under the patents or other intellectual property of the third party, or a license from TI under the patents or other intellectual property of TI.

TI RESOURCES ARE PROVIDED "AS IS" AND WITH ALL FAULTS. TI DISCLAIMS ALL OTHER WARRANTIES OR REPRESENTATIONS, EXPRESS OR IMPLIED, REGARDING RESOURCES OR USE THEREOF, INCLUDING BUT NOT LIMITED TO ACCURACY OR COMPLETENESS, TITLE, ANY EPIDEMIC FAILURE WARRANTY AND ANY IMPLIED WARRANTIES OF MERCHANTABILITY, FITNESS FOR A PARTICULAR PURPOSE, AND NON-INFRINGEMENT OF ANY THIRD PARTY INTELLECTUAL PROPERTY RIGHTS. TI SHALL NOT BE LIABLE FOR AND SHALL NOT DEFEND OR INDEMNIFY DESIGNER AGAINST ANY CLAIM, INCLUDING BUT NOT LIMITED TO ANY INFRINGEMENT CLAIM THAT RELATES TO OR IS BASED ON ANY COMBINATION OF PRODUCTS EVEN IF DESCRIBED IN TI RESOURCES OR OTHERWISE. IN NO EVENT SHALL TI BE LIABLE FOR ANY ACTUAL, DIRECT, SPECIAL, COLLATERAL, INDIRECT, PUNITIVE, INCIDENTAL, CONSEQUENTIAL OR EXEMPLARY DAMAGES IN CONNECTION WITH OR ARISING OUT OF TI RESOURCES OR USE THEREOF, AND REGARDLESS OF WHETHER TI HAS BEEN ADVISED OF THE POSSIBILITY OF SUCH DAMAGES.

Unless TI has explicitly designated an individual product as meeting the requirements of a particular industry standard (e.g., ISO/TS 16949 and ISO 26262), TI is not responsible for any failure to meet such industry standard requirements.

Where TI specifically promotes products as facilitating functional safety or as compliant with industry functional safety standards, such products are intended to help enable customers to design and create their own applications that meet applicable functional safety standards and requirements. Using products in an application does not by itself establish any safety features in the application. Designers must ensure compliance with safety-related requirements and standards applicable to their applications. Designer may not use any TI products in life-critical medical equipment unless authorized officers of the parties have executed a special contract specifically governing such use. Life-critical medical equipment is medical equipment where failure of such equipment would cause serious bodily injury or death (e.g., life support, pacemakers, defibrillators, heart pumps, neurostimulators, and implantables). Such equipment includes, without limitation, all medical devices identified by the U.S. Food and Drug Administration as Class III devices and equivalent classifications outside the U.S.

TI may expressly designate certain products as completing a particular qualification (e.g., Q100, Military Grade, or Enhanced Product). Designers agree that it has the necessary expertise to select the product with the appropriate qualification designation for their applications and that proper product selection is at Designers' own risk. Designers are solely responsible for compliance with all legal and regulatory requirements in connection with such selection.

Designer will fully indemnify TI and its representatives against any damages, costs, losses, and/or liabilities arising out of Designer's non-compliance with the terms and provisions of this Notice.