

# PRODUCT SPECIFICATION

**Model No.: FYL-5013IRBC1C**

Descriptions:
<ul style="list-style-type: none"> <li>■ Dice material: AlGaAs.</li> <li>■ Emitting Color: Infrared.</li> <li>■ Device Outline: Φ5mm round type.</li> <li>■ Lens Type: Water clear.</li> </ul>



CUSTOMER APPROVED SIGNATURES	APPROVED BY	CHECKED BY	PREPARED BY

**NINGBO FORYARD OPTOELECTRONICS CO.,LTD.**

**Add:**No. 666 Jinghua Road, Hi-tech Park, Ningbo, Zhejiang, China

**Zip:**315103

**Tel:** 0086-574-87933652 87922206 87927870

**Fax:** 0086-574-87927917

**E-mail:**Sales@foryard.com (General)

**Model No.: FYL-5013IRBC1C**

**■ Features**

- 1.Low power consumption.
- 2.High efficiency.
- 3.General purpose leads.
- 4.High intensity.
- 5.RoHs compliant.

**■ Package configuration**

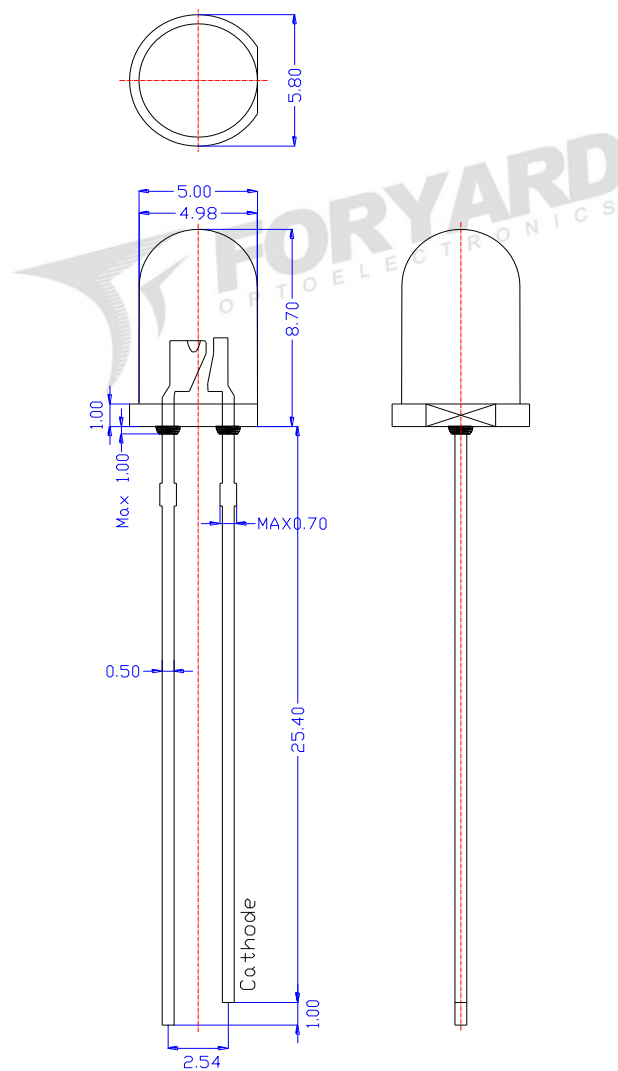

**Notes:**

1. All dimensions are millimeters (inches)
2. Tolerance is  $\pm 0.25\text{mm}$  (.010") unless otherwise noted.
3. The specifications, characteristics and technical data described in the datasheet are subject to change without prior notice.
4. The drawing is different from the actual one, please refer to the sample.

Model No.: FYL-5013IRBC1C

### ■ Absolute Maximum Ratings(Ta=25°C)

Parameter	Symbol	MAX.	Test Condition	Unit
Power Dissipation	Pd	100	---	mW
Peak Forward Current (1/10 Duty Cycle, 0.1ms Pulse Width)	IFM	600	Duty=0.01ms 1khz	mA
Reverse Voltage	VR	9	IR=10UA	V
Operating Temperature Range	-40°C to +85°C			
Storage Temperature Range	-40°C to +100°C			
Lead Soldering Temperature[4mm(.157") From Body]	260°C for 5 Seconds			

### ■ Typical Electrical & Optical Characteristics(Ta=25°C)

Parameter	Symbol	Min.	Typ.	Max.	Unit	Test Condition
Radiant Intensity	Ee	45	70	---	mW/sr	IF=50mA
Viewing Angle	$2\theta_{1/2}$	---	20	---	Deg	
Peak Emission Wavelength	$\lambda_p$	---	880	---	nm	
Spectral Line Half-Width	$\Delta\lambda$	40	45	50	nm	
Forward Voltage	$V_F$	---	1.5	1.7	V	VR=5V
Reverse Current	$I_R$	---	---	10	$\mu A$	

Note:

- 1.Luminous Intensity is based on the Foryard standards.
- 2.Pay attention about static for InGaN

**Model No.: FYL-5013IRBC1C**

**Typical Electrical/Optical Characteristics Curves(Ta=25°C Unless Otherwise Noted)**

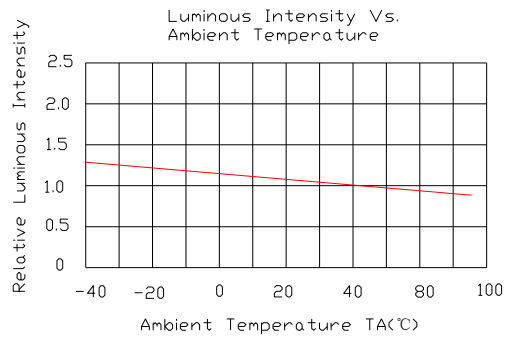
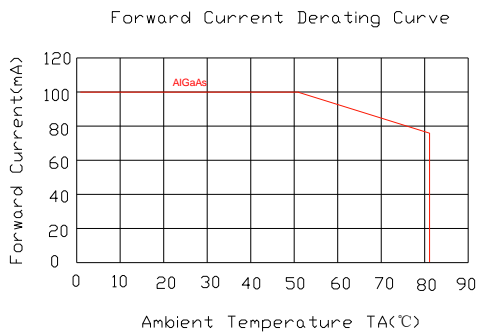
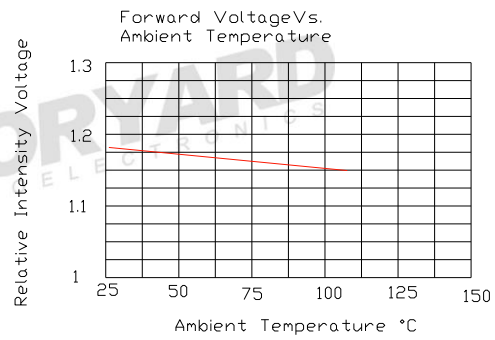
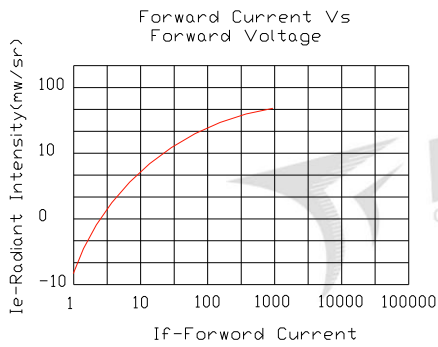
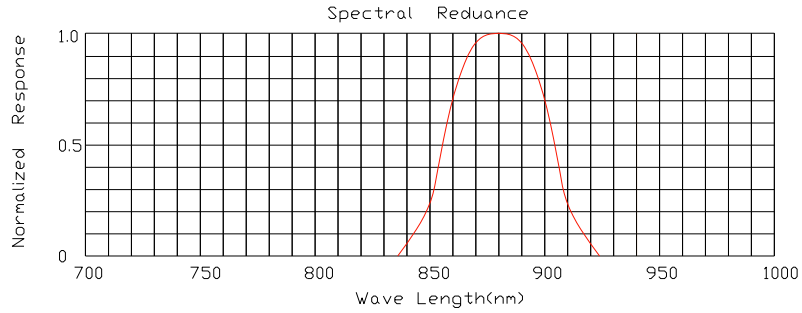

**Radiation pattern**

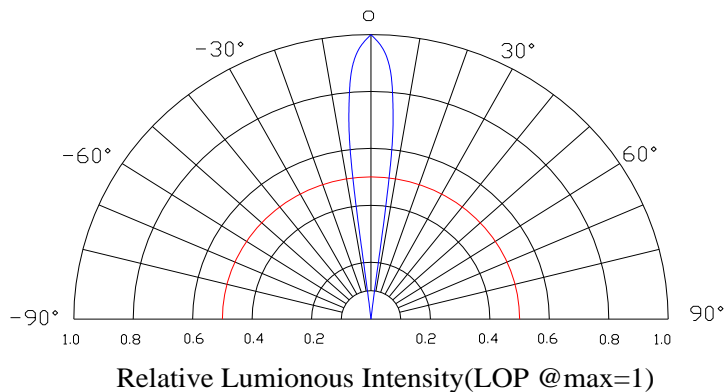

Model No.	FYL-5013IRBC1C
Date / Rev.	2020.05.08 / A

**Model No.: FYL-5013IRBC1C**

**LAMP PACKING.**

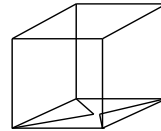
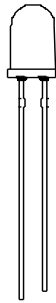

5mm 1000PCS/Polybag

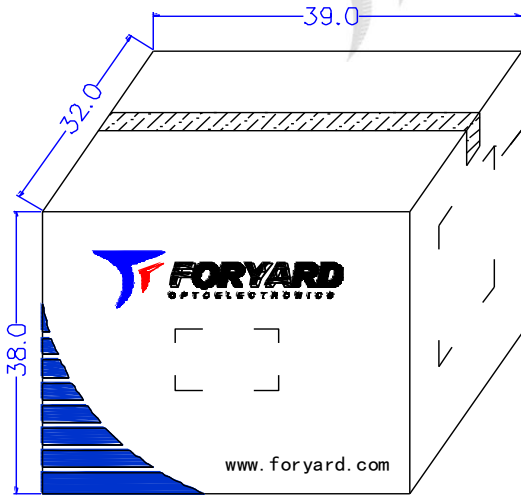

48000PCS/Carton

OUTSIDE LABEL

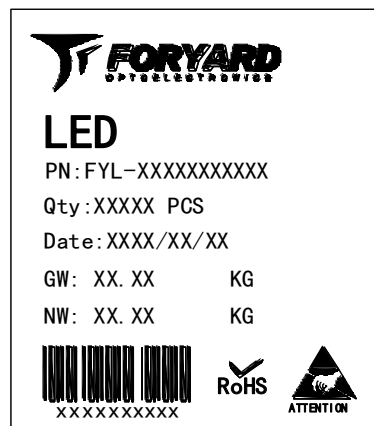
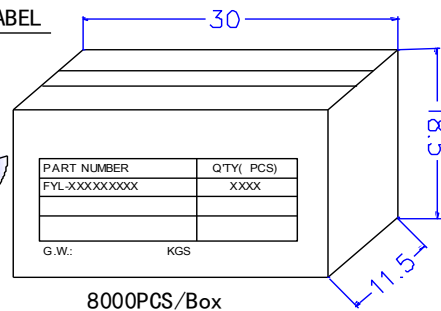

OUTSIDE LABEL

Note: The specifications are subject to change without notice. Please contact us for updated information.