

PRODUCT SPECIFICATION

Model No.: FYL-5013PD1C

Descriptions:

- Emitting Color: Photo diode.
- Device Outline: $\Phi 5\text{mm}$ round type.
- Lens Type: Deep blue.



CUSTOMER APPROVED SIGNATURES	APPROVED BY	CHECKED BY	PREPARED BY

NINGBO FORYARD OPTOELECTRONICS CO.,LTD.

Add:No. 666 Jinghua Road, Hi-tech Park, Ningbo, Zhejiang, China

Zip:315103

Tel: 0086-574-87933652 87922206 87927870

Fax: 0086-574-87927917

E-mail:Sales@foryard.com (General)

Model No.: FYL-5013PD1C

■ Features

- 1.Low power consumption.
- 2.High efficiency.
- 3.General purpose leads.
- 4.High intensity.
- 5.RoHs compliant.

■ Package configuration

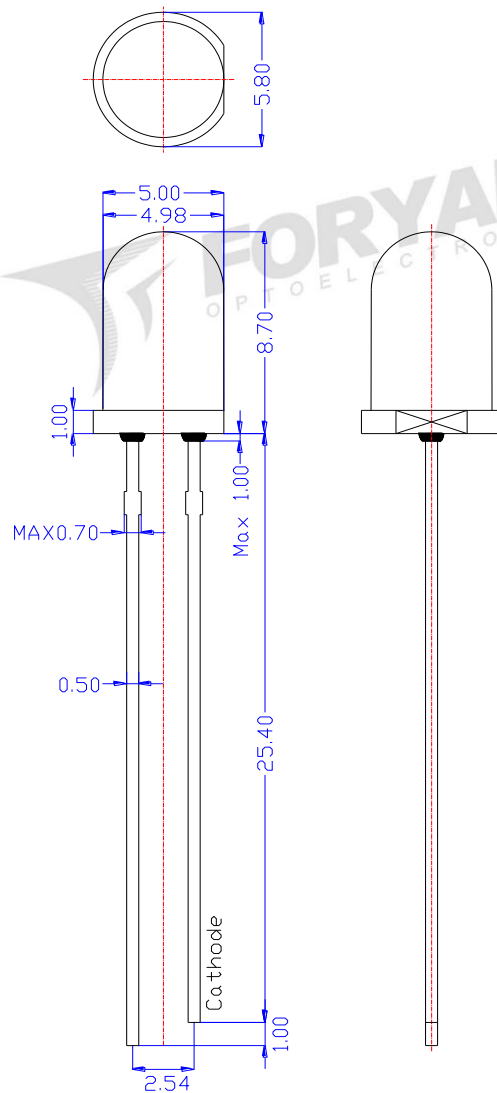

Notes:

1. All dimensions are millimeters (inches)
2. Tolerance is $\pm 0.25\text{mm}(.010\text{'})$ unless otherwise noted.
3. The specifications, characteristics and technical data described in the datasheet are subject to change without prior notice.
- 4.The drawing is different from the actual one, please refer to the sample.

Model No.: FYL-5013PD1C

■ Absolute Maximum Ratings(Ta=25°C)

Parameter	Symbol	Min.	Typ.	Max.	Test Condition	Unit
Reverse Breakdown Voltage	V_{BR}	35	170	---	$I_R=100\mu A, H=0\text{mw/cm}^2$	V
Operating Temperature	T_{opr}	-30	---	85	---	°C
Storage Temperature	T_{str}	-30	---	100	---	°C

■ Typical Electrical & Optical Characteristics(Ta=25°C)

Parameter	Symbol	Min.	Typ.	Max.	Test Condition	Unit
Forward Voltage	VF	0.5	1.3	1.7	IF=20mA	V
Peak Sensing Wavelength	λ_p	---	940	---	IF=20mA	nm
Light Current	IL	---	1.8	--	$V_R=5V, 1\text{mw/cm}^2 @ 940\text{nm}$	μA
Reverse Dark Current	ID	---	2	10	$H=0\text{mw/cm}^2, V_R=10V$	nA
Junction Capacitance	CJ	---	1.5	--	$V_R=3V, F=1\text{MHZ}, H=0\text{mw/cm}^2$	PF

Note:

- 1.Luminous Intensity is based on the Foryard standards.
- 2.Pay attention about static for InGaN

Model No.	FYL-5013PD1C
Date / Rev.	2020.05.08 / A

Model No.: FYL-5013PD1C

LAMP PACKING.

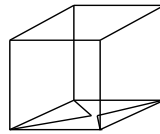
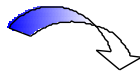
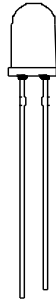

5mm 1000PCS/Polybag

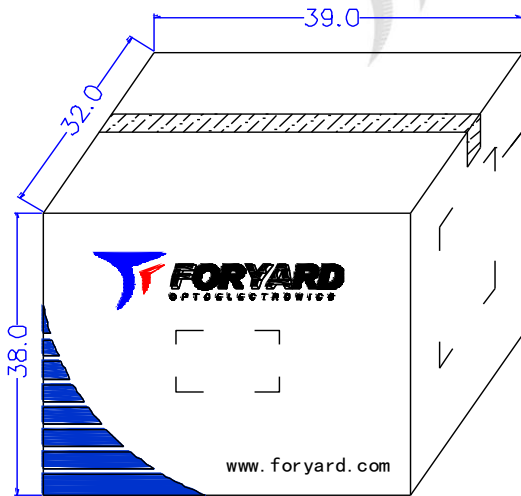
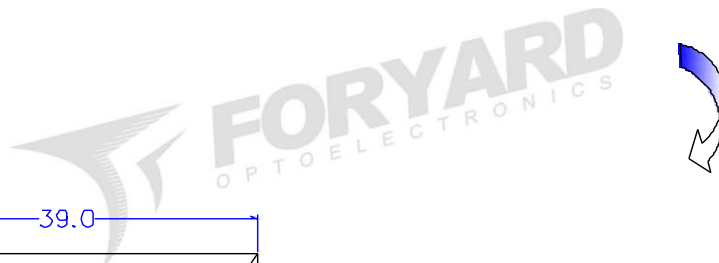

48000PCS/Carton

OUTSIDE LABEL

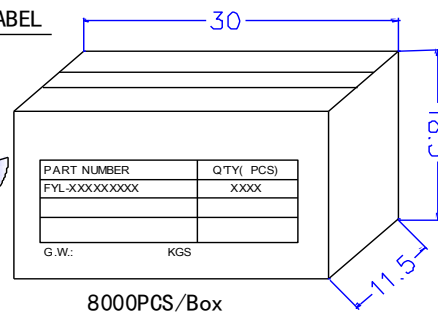

8000PCS/Box

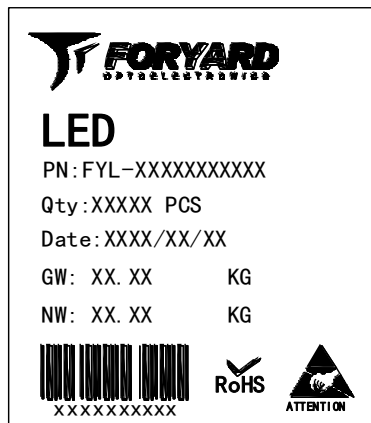

OUTSIDE LABEL

Note: The specifications are subject to change without notice. Please contact us for updated information.