

BC856/857/858/859/860

Switching and Amplifier Applications

- Suitable for automatic insertion in thick and thin-film circuits
- Low Noise: BC859, BC860
- Complement to BC846 ... BC850

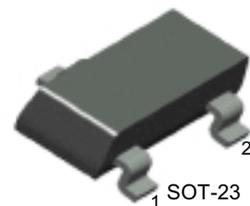

SOT-23
1. Base 2. Emitter 3. Collector

PNP Epitaxial Silicon Transistor

Absolute Maximum Ratings $T_a=25^\circ\text{C}$ unless otherwise noted

Symbol	Parameter	Value	Units	
V_{CBO}	Collector-Base Voltage	: BC856	-80	V
		: BC857/860	-50	V
		: BC858/859	-30	V
V_{CEO}	Collector-Emitter Voltage	: BC856	-65	V
		: BC857/860	-45	V
		: BC858/859	-30	V
V_{EBO}	Emitter-Base Voltage	-5	V	
I_C	Collector Current (DC)	-100	mA	
P_C	Collector Dissipation	310	mW	
T_J	Junction Temperature	150	$^\circ\text{C}$	
T_{STG}	Storage Temperature	-65 ~ 150	$^\circ\text{C}$	

Electrical Characteristics $T_a=25^\circ\text{C}$ unless otherwise noted

Symbol	Parameter	Test Condition	Min.	Typ.	Max.	Units
I_{CBO}	Collector Cut-off Current	$V_{CB} = -30\text{V}, I_E = 0$			-15	nA
h_{FE}	DC Current Gain	$V_{CE} = -5\text{V}, I_C = -2\text{mA}$	110		800	
$V_{CE}(\text{sat})$	Collector-Emitter Saturation Voltage	$I_C = -10\text{mA}, I_B = -0.5\text{mA}$		-90	-300	mV
		$I_C = -100\text{mA}, I_B = -5\text{mA}$		-250	-650	mV
$V_{BE}(\text{sat})$	Base-Emitter Saturation Voltage	$I_C = -10\text{mA}, I_B = -0.5\text{mA}$		-700		mV
		$I_C = -100\text{mA}, I_B = -5\text{mA}$		-900		mV
$V_{BE}(\text{on})$	Base-Emitter On Voltage	$V_{CE} = -5\text{V}, I_C = -2\text{mA}$	-600	-660	-750	mV
		$V_{CE} = -5\text{V}, I_C = -10\text{mA}$			-800	mV
f_T	Current Gain Bandwidth Product	$V_{CE} = -5\text{V}, I_C = -10\text{mA}$ $f = 100\text{MHz}$		150		MHz
C_{ob}	Output Capacitance	$V_{CB} = -10\text{V}, I_E = 0, f = 1\text{MHz}$			6	pF
NF	Noise Figure	: BC856/857/858		2	10	dB
		: BC859/860	$V_{CE} = -5\text{V}, I_C = -200\mu\text{A}$ $f = 1\text{KHz}, R_G = 2\text{K}\Omega$	1	4	dB
		: BC859	$V_{CE} = -5\text{V}, I_C = -200\mu\text{A}$	1.2	4	dB
		: BC860	$R_G = 2\text{K}\Omega, f = 30 \sim 15000\text{Hz}$	1.2	2	dB

h_{FE} Classification

Classification	A	B	C
h_{FE}	110 ~ 220	200 ~ 450	420 ~ 800

Marking Code

Type	856A	856B	856C	857A	857B	857C	858A	858B	858C
Mark	9AA	9AB	9AC	9BA	9BB	9BC	9CA	9CB	9CC
Type	859A	859B	859C	860A	860B	860C			
Mark	9DA	9DB	9DC	9EA	9EB	9EC			

Typical Characteristics

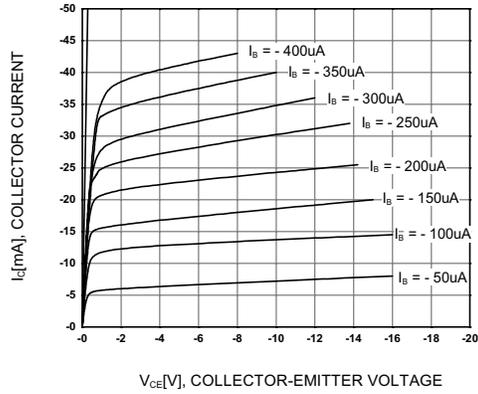

Figure 1. Static Characteristic

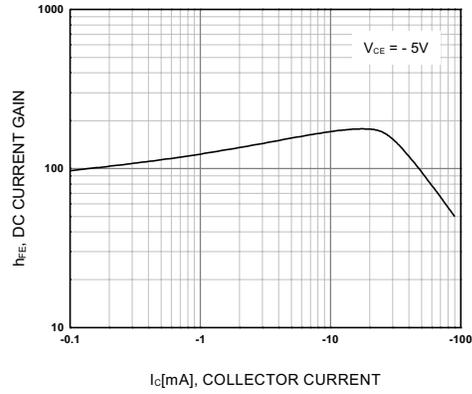

Figure 2. DC current Gain

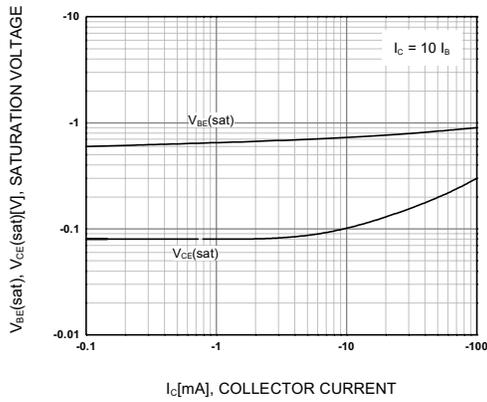

Figure 3. Base-Emitter Saturation Voltage
Collector-Emitter Saturation Voltage

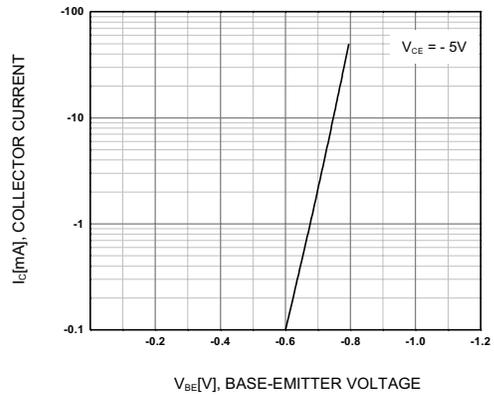

Figure 4. Base-Emitter On Voltage

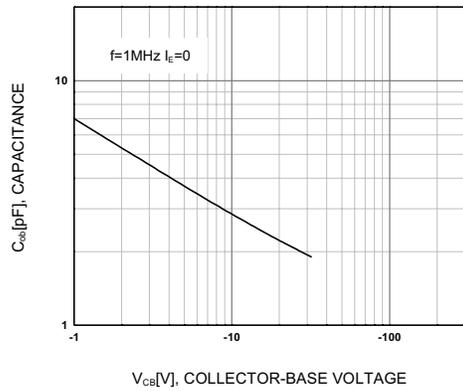

Figure 5. Collector Output Capacitance

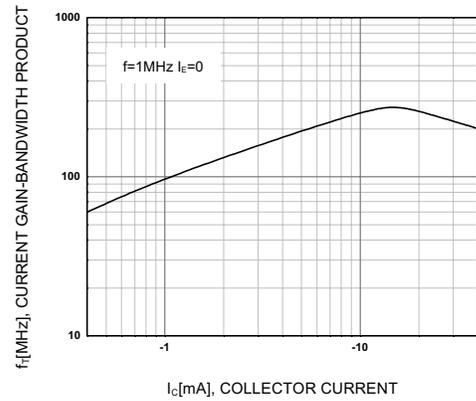
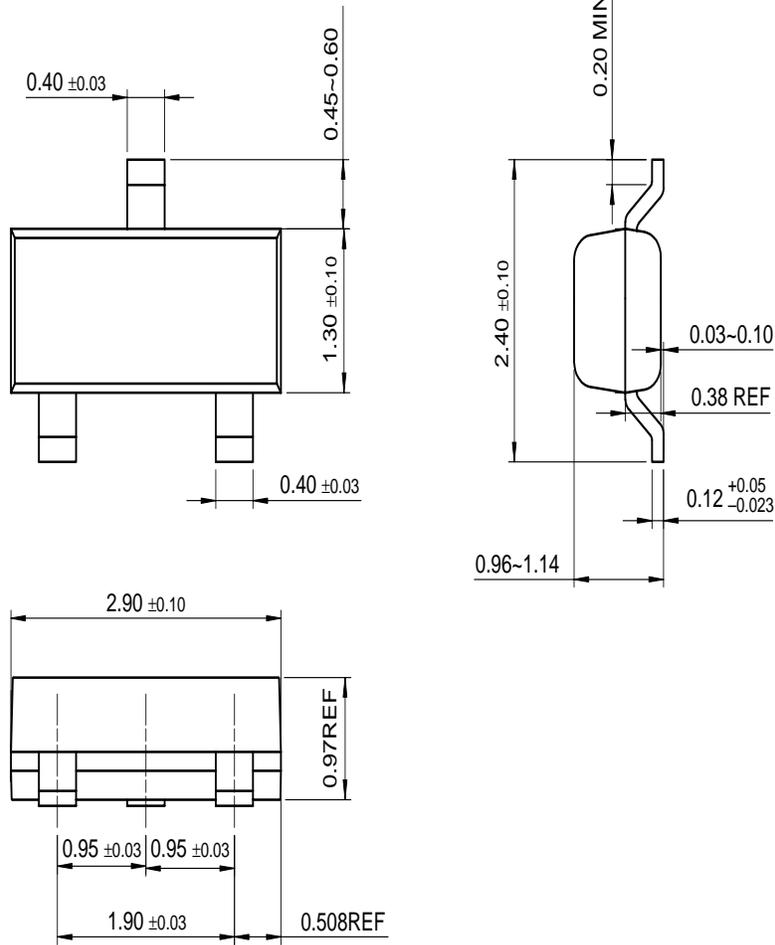

Figure 6. Current Gain Bandwidth Product

Package Dimensions

SOT-23



Dimensions in Millimeters

BC856/857/858/859/860

TRADEMARKS

The following are registered and unregistered trademarks Fairchild Semiconductor owns or is authorized to use and is not intended to be an exhaustive list of all such trademarks.

ACEx™	HiSeC™	SuperSOT™-8
Bottomless™	ISOPLANAR™	SyncFET™
CoolFET™	MICROWIRE™	TinyLogic™
CROSSVOLT™	POP™	UHC™
E ² CMOS™	PowerTrench®	VCX™
FACT™	QFET™	
FACT Quiet Series™	QS™	
FAST®	Quiet Series™	
FASTr™	SuperSOT™-3	
GTO™	SuperSOT™-6	

DISCLAIMER

FAIRCHILD SEMICONDUCTOR RESERVES THE RIGHT TO MAKE CHANGES WITHOUT FURTHER NOTICE TO ANY PRODUCTS HEREIN TO IMPROVE RELIABILITY, FUNCTION OR DESIGN. FAIRCHILD DOES NOT ASSUME ANY LIABILITY ARISING OUT OF THE APPLICATION OR USE OF ANY PRODUCT OR CIRCUIT DESCRIBED HEREIN; NEITHER DOES IT CONVEY ANY LICENSE UNDER ITS PATENT RIGHTS, NOR THE RIGHTS OF OTHERS.

LIFE SUPPORT POLICY

FAIRCHILD'S PRODUCTS ARE NOT AUTHORIZED FOR USE AS CRITICAL COMPONENTS IN LIFE SUPPORT DEVICES OR SYSTEMS WITHOUT THE EXPRESS WRITTEN APPROVAL OF FAIRCHILD SEMICONDUCTOR INTERNATIONAL.

As used herein:

1. Life support devices or systems are devices or systems which, (a) are intended for surgical implant into the body, or (b) support or sustain life, or (c) whose failure to perform when properly used in accordance with instructions for use provided in the labeling, can be reasonably expected to result in significant injury to the user.
2. A critical component is any component of a life support device or system whose failure to perform can be reasonably expected to cause the failure of the life support device or system, or to affect its safety or effectiveness.

PRODUCT STATUS DEFINITIONS

Definition of Terms

Datasheet Identification	Product Status	Definition
Advance Information	Formative or In Design	This datasheet contains the design specifications for product development. Specifications may change in any manner without notice.
Preliminary	First Production	This datasheet contains preliminary data, and supplementary data will be published at a later date. Fairchild Semiconductor reserves the right to make changes at any time without notice in order to improve design.
No Identification Needed	Full Production	This datasheet contains final specifications. Fairchild Semiconductor reserves the right to make changes at any time without notice in order to improve design.
Obsolete	Not In Production	This datasheet contains specifications on a product that has been discontinued by Fairchild semiconductor. The datasheet is printed for reference information only.