

Features

- Fixed Output Voltage:
 - 1.25 V, 2.048 V, 2.5 V, 3 V, 3.3 V, 4.096 V
- High Initial Accuracy and Low Temperature Coefficient
 - Max 0.2%
 - 30 ppm/°C at -40°C to 85°C
 - 50 ppm/°C at -40°C to 125°C
- Operation From -40°C to 125°C
- Low Output Noise: 50 μ Vpp of TPR3525
- Quiescent current: 210 μ A
- Stable with 0.1 to 10 μ F Capacitive Loads

Applications

- Power
- Instrumentation
- Industry

Pin Configuration

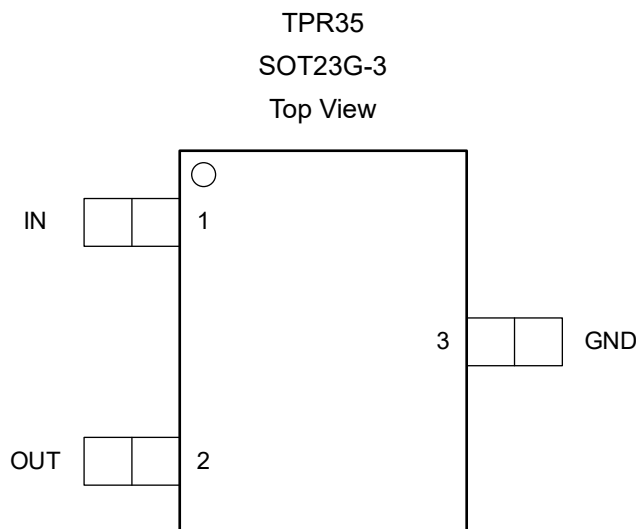

Description

The TPR35 is a voltage reference with guaranteed temperature stability over the entire operating temperature range. The temperature range is extended from -40 °C to +125 °C.

Product Family Table

Order Number	Output Voltage (V)	Package
TPR3512-S3TR	1.25	SOT23G-3
TPR3520-S3TR	2.048	SOT23G-3
TPR3525-S3TR	2.5	SOT23G-3
TPR3530-S3TR	3	SOT23G-3
TPR3533-S3TR	3.3	SOT23G-3
TPR3540-S3TR	4.096	SOT23G-3

Table of Contents

Features	1
Applications	1
Description	1
Pin Configuration	1
Product Family Table	2
Revision History	4
Specifications	5
Absolute Maximum Ratings.....	5
ESD, Electrostatic Discharge Protection	5
Recommended Operating Conditions	5
Thermal Information	5
Electrical Characteristics	6
Typical Performance Characteristics – TPR3525	8
Tape and Reel Information	11
Package Outline Dimensions	12
SOT23G-3	12
Order Information	13

Revision History

Date	Revision	Notes
2020-9-10	Rev.A.0	Initial Version.
2021-11-24	Rev.A.1	1. Updated ESD Rating 2. Added Tape and Reel Information
2022-05-31	Rev.A.2	1. Added Recommended Operating Conditions 2. Added item of ISC, Short-circuit current, in Electrical Characteristics 3. Added typical value of Long-term stability 4. Corrected test conditions in the Electrical Characteristics table
2022-07-22	Rev.A.3	1. Corrected the information in Feature 2. Added figures in the Typical Performance Characteristics table

Specifications

Absolute Maximum Ratings ⁽¹⁾

Parameter		Min	Max	Unit
V _{IN}	Supply Voltage	-0.3	6.9	V
T _J	Junction Temperature Range	-40	150	°C
T _A	Operating Temperature Range	-40	125	°C
T _{STG}	Storage Temperature Range	-65	150	°C
T _L	Lead Temperature (Soldering 10 sec)		260	°C

(1) Stresses beyond those listed under Absolute Maximum Ratings may cause permanent damage to the device. Exposure to any Absolute Maximum Rating condition for extended periods may affect device reliability and lifetime.

ESD, Electrostatic Discharge Protection

Symbol	Parameter	Condition	Minimum Level	Unit
HBM	Human Body Model ESD	ANSI/ESDA/JEDEC JS-001 ⁽¹⁾	±4	kV
CDM	Charged Device Model ESD	ANSI/ESDA/JEDEC JS-002 ⁽²⁾	±1.5	kV

(1) JEDEC document JEP155 states that 500-V HBM allows safe manufacturing with a standard ESD control process.

(2) JEDEC document JEP157 states that 250-V CDM allows safe manufacturing with a standard ESD control process.

Recommended Operating Conditions

Parameter		Min	Max	Unit
V _{IN}	Supply Voltage	2.1	5.5	V
I _{OUT}	Output Current	-20	20	mA
T _J	Junction Temperature Range	-40	125	°C

Thermal Information

Package Type	θ _{JA}	θ _{JC}	Unit
SOT23G-3	250	81	°C/W
QFN 1.5X1.5-8	80	40	°C/W

Electrical Characteristics

 All test conditions: $V_{IN} = 5\text{ V}$, $T_A = +25^\circ\text{C}$, unless otherwise noted.

Symbol	Parameter	Conditions	Min	Typ	Max	Unit
TPR3512						
V_{OUT}	Output Voltage			1.25		V
	Initial Accuracy		-0.2		0.2	%
	Output Voltage Noise	f = 0.1 Hz to 10 Hz		25		μVpp
TPR3520						
V_{OUT}	Output Voltage			2.048		V
	Initial Accuracy		-0.2		0.2	%
	Output Voltage Noise	f = 0.1 Hz to 10 Hz		40		μVpp
TPR3525						
V_{OUT}	Output Voltage			2.5		V
	Initial Accuracy		-0.2		0.2	%
	Output Voltage Noise	f = 0.1 Hz to 10 Hz		50		μVpp
TPR3530						
V_{OUT}	Output Voltage			3.0		V
	Initial Accuracy		-0.2		0.2	%
	Output Voltage Noise	f = 0.1 Hz to 10 Hz		60		μVpp
TPR3533						
V_{OUT}	Output Voltage			3.3		V
	Initial Accuracy		-0.2		0.2	%
	Output Voltage Noise	f = 0.1 Hz to 10 Hz		66		μVpp
TPR3540						
V_{OUT}	Output Voltage			4.096		V
	Initial Accuracy		-0.2		0.2	%
	Output Voltage Noise	f = 0.1 Hz to 10 Hz		80		μVpp

Electrical Characteristics (Continued)

 All test conditions: $V_{IN} = 5\text{ V}$, $T_A = +25^\circ\text{C}$, unless otherwise noted.

Symbol	Parameter	Conditions	Min	Typ	Max	Unit	
TPR3512, TPR3520, TPR3525, TPR3530, TPR3533, TPR3540, Power Supply							
V_{IN}	Supply Voltage	TPR3512	2.1		5.5	V	
		All parts except TPR3512, $I_{LOAD} = \pm 1\text{ mA}$	$V_{OUT} + 0.05$		5.5	V	
I_q	Quiescent Current			150	210	μA	
		$T_A = -40\text{ to }125^\circ\text{C}$			250	μA	
	Minimum Dropout Voltage	$I_{LOAD} = \pm 1\text{ mA}$, all parts except TPR3512	$T_A = 25^\circ\text{C}$		25	50	mV
			$T_A = 0\text{ to }70^\circ\text{C}$			50	mV
			$T_A = -40\text{ to }125^\circ\text{C}$			100	mV
		$I_{LOAD} = \pm 5\text{ mA}$, all parts except TPR3512	$T_A = 25^\circ\text{C}$			200	mV
			$T_A = -40\text{ to }125^\circ\text{C}$			250	mV
TPR3512, TPR3520, TPR3525, TPR3530, TPR3533, TPR3540, Reference Output							
	Output Voltage Temperature Drift	$T_A = -40\text{ to }85^\circ\text{C}$		10	30	ppm/ $^\circ\text{C}$	
		$T_A = -40\text{ to }125^\circ\text{C}$		20	50		
	Line Regulation, TPR3512	$V_{IN} = 2.1\text{ to }5.5\text{ V}^{(1)}$	-65		65	ppm/V	
		$V_{IN} = 2.1\text{ to }5.5\text{ V}^{(1)}$, $T_A = -40\text{ to }125^\circ\text{C}$	-85		85	ppm/V	
	Line Regulation, TPR35XX except for TPR3512	$V_{IN} = V_{OUT} + 300\text{ mV}$ to 5.5 V		-50		50	ppm/V
			$T_A = -40\text{ to }125^\circ\text{C}$	-70		70	ppm/V
	Load Regulation	$V_{IN} = V_{OUT} + 300\text{ mV}$, $I_{LOAD} = -5\text{ to }5\text{ mA}^{(1)}$		-20	20	ppm/mA	
			$T_A = -40\text{ to }125^\circ\text{C}$	-30		30	ppm/mA
	Long Term Stability	0 to 1000 hours, $T_A = 25^\circ\text{C}$		200		ppm	
		1000 to 2000 hours, $T_A = 25^\circ\text{C}$		200		ppm	
	Thermal Hysteresis			80		ppm	
I_{SC}	Short-circuit Current	Sourcing and sinking		50		mA	
	Capacitive Load		0.1		10	μF	
	Turn-on Settling Time	To 0.1% with $C_L = 1\ \mu\text{F}$		500		μs	

(1) The minimum supply voltage for the TPR3512 is 2.1 V.

Typical Performance Characteristics – TPR3525

All test conditions: $T_A = +25^\circ\text{C}$, unless otherwise noted.

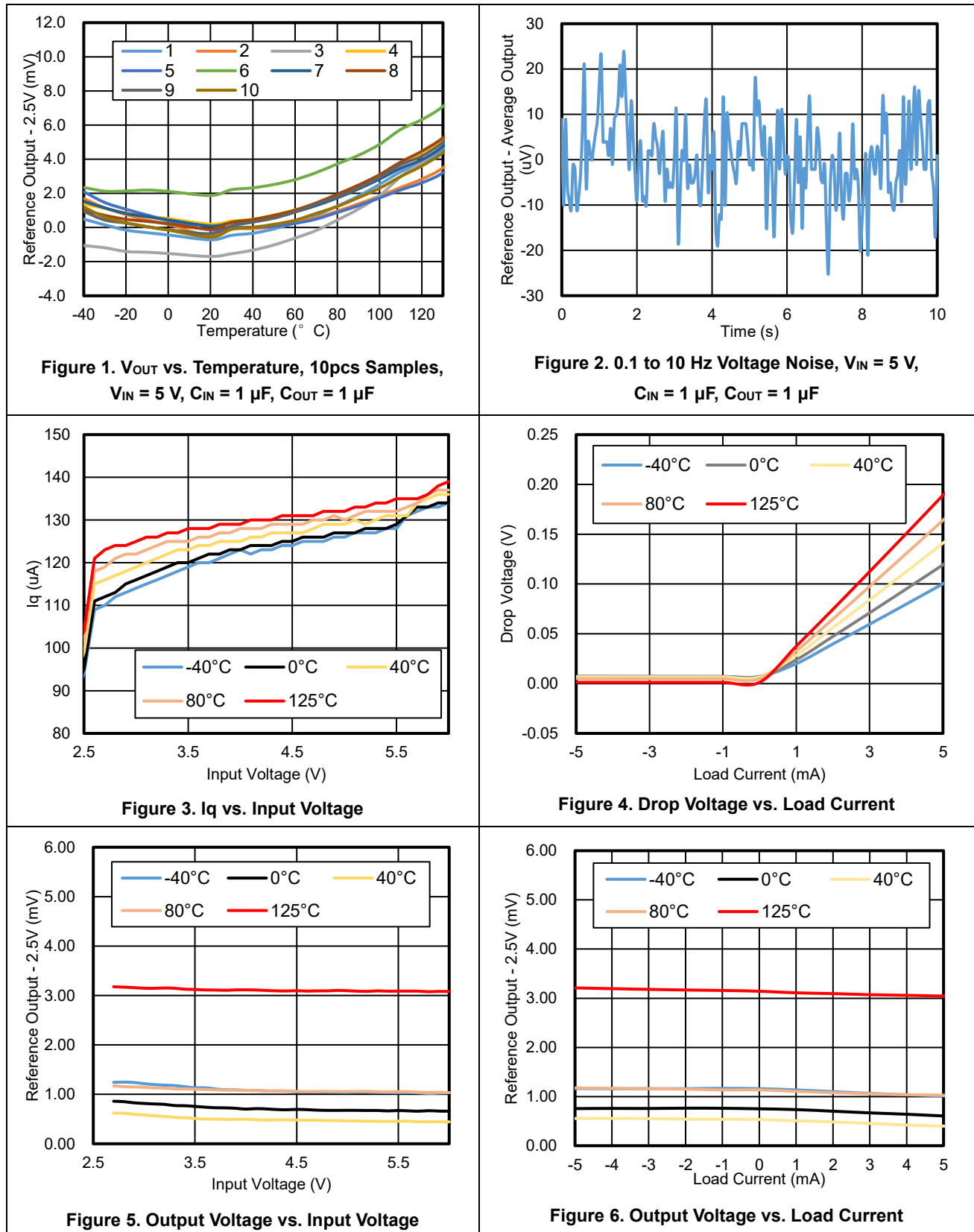

Typical Performance Characteristics – TPR3525 (Continued)

All test conditions: $T_A = +25^\circ\text{C}$, unless otherwise noted.

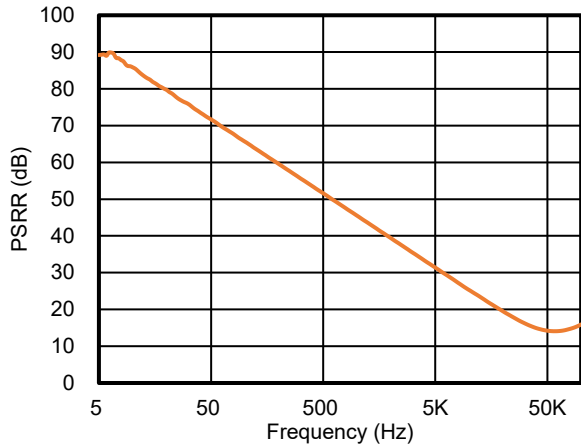

Figure 7. PSRR vs. Frequency

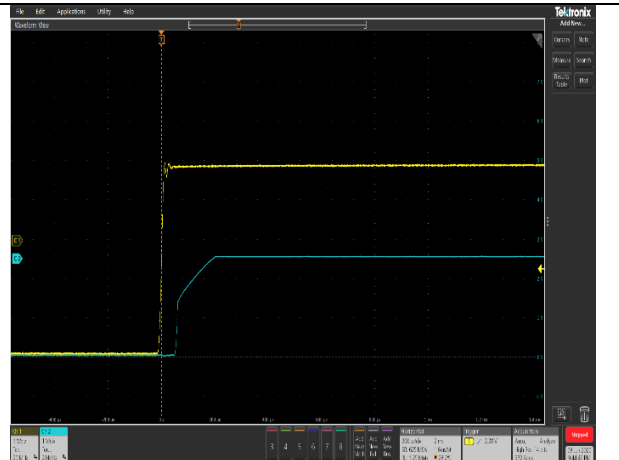

Figure 8. Step Response, $V_{IN} = 5\text{ V}$, $C_{IN} = 1\ \mu\text{F}$, $C_{OUT} = 0.1\ \mu\text{F}$, $200\ \mu\text{s/div}$

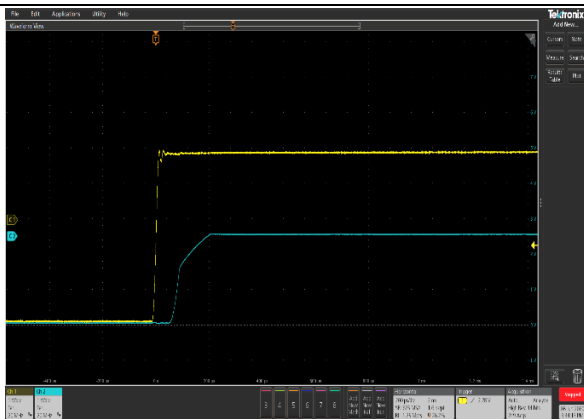

Figure 9. Step Response, $V_{IN} = 5\text{ V}$, $C_{IN} = 1\ \mu\text{F}$, $C_{OUT} = 1\ \mu\text{F}$, $200\ \mu\text{s/div}$

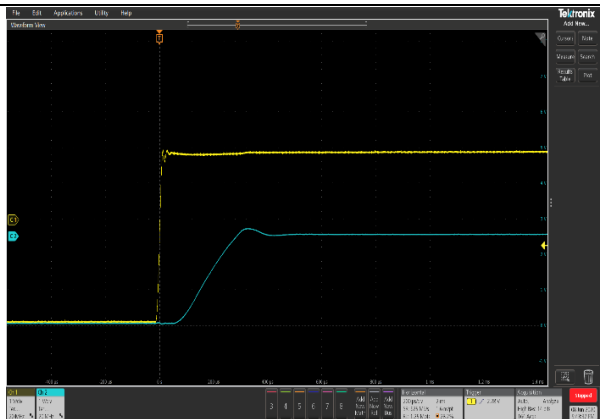

Figure 10. Step Response, $V_{IN} = 5\text{ V}$, $V_{IN} = 5\text{ V}$, $C_{IN} = 1\ \mu\text{F}$, $C_{OUT} = 10\ \mu\text{F}$, $200\ \mu\text{s/div}$



Figure 11. Load Transient, $\pm 5\text{ mA}$, $V_{IN} = 5\text{ V}$, $C_{IN} = 1\ \mu\text{F}$, $C_{OUT} = 1\ \mu\text{F}$, 50 mV/div



Figure 12. Load Transient, $\pm 5\text{ mA}$, $V_{IN} = 2.8\text{ V}$, $C_{IN} = 1\ \mu\text{F}$, $C_{OUT} = 1\ \mu\text{F}$, 50 mV/div

Typical Performance Characteristics – TPR3525 (Continued)

All test conditions: $T_A = +25^\circ\text{C}$, unless otherwise noted.



Figure 13. Load Transient, $\pm 2\text{ mA}$, $V_{IN} = 5\text{ V}$,
 $C_{IN} = 1\ \mu\text{F}$, $C_{OUT} = 1\ \mu\text{F}$, 20 mV/div



Figure 14. Load Transient, $\pm 2\text{ mA}$, $V_{IN} = 2.8\text{ V}$,
 $C_{IN} = 1\ \mu\text{F}$, $C_{OUT} = 1\ \mu\text{F}$, 20 mV/div

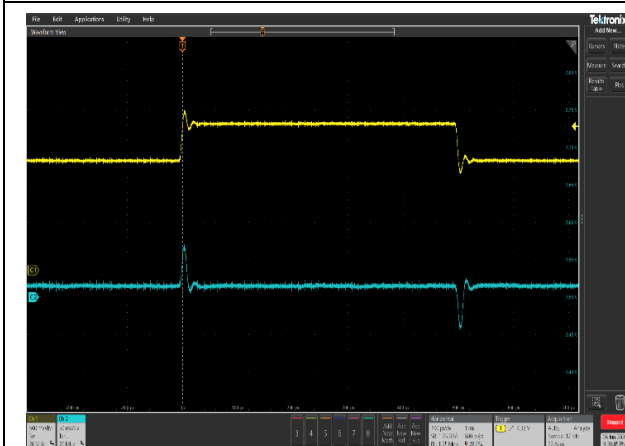

Figure 15. Line Transient, 500 mV Step,
 $C_{IN} = 1\ \mu\text{F}$, $C_{OUT} = 1\ \mu\text{F}$, 50 mV/div

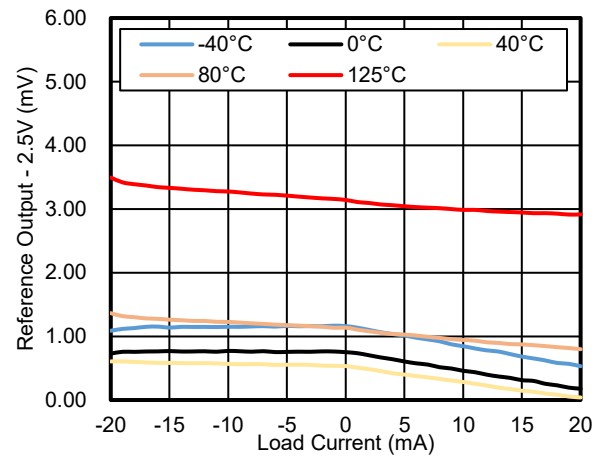
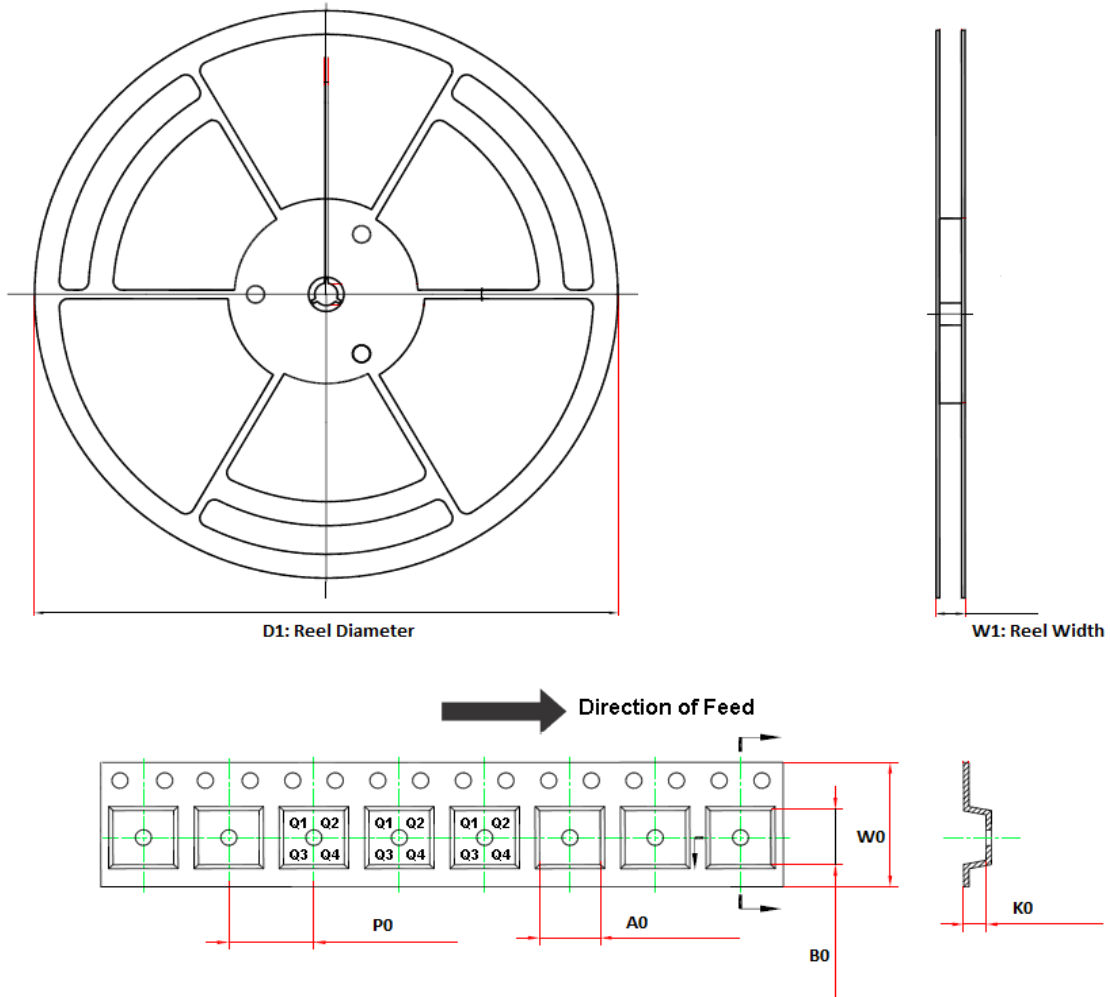

Figure 16. Output Voltage vs. Load Current

Tape and Reel Information



Order Number	Package	D1 (mm)	W1 (mm)	A0 (mm)	B0 (mm)	K0 (mm)	P0 (mm)	W0 (mm)	Pin1 Quadrant
TPR35xx-S3TR	SOT23G-3	178	12.1	3.15	2.77	1.22	4.0	8.0	Q3

(1) Output voltage, xx = 12 to 40.

Package Outline Dimensions

SOT23G-3

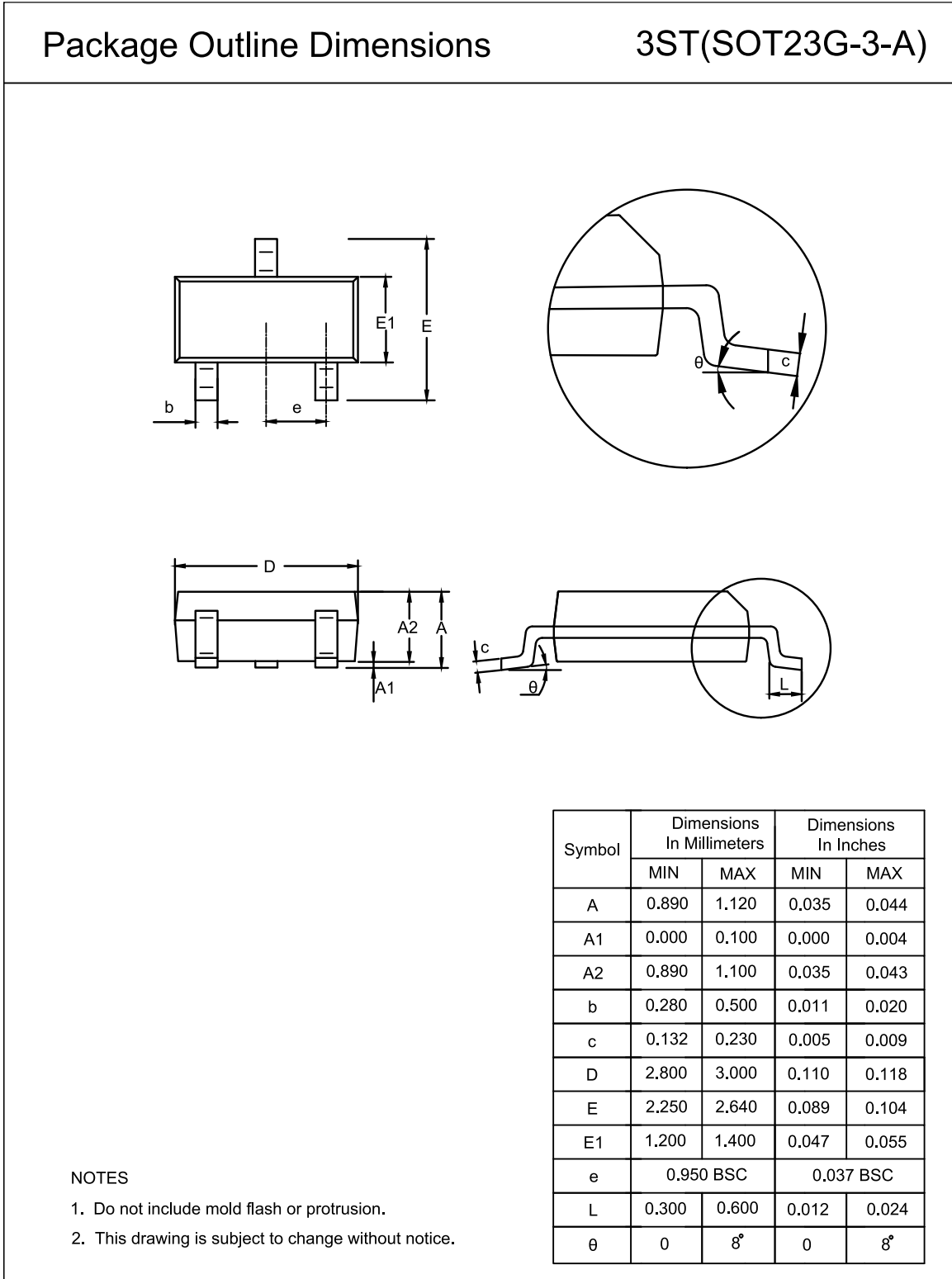

Order Information

Order Number	Operating Temperature Range	Package	Marking Information	MSL	Transport Media, Quantity	Eco Plan
TPR3512-S3TR	-40 to 125°C	SOT23G-3	R3A	MSL3	3,000	Green
TPR3520-S3TR	-40 to 125°C	SOT23G-3	R3B	MSL3	3,000	Green
TPR3525-S3TR	-40 to 125°C	SOT23G-3	R3C	MSL3	3,000	Green
TPR3530-S3TR	-40 to 125°C	SOT23G-3	R3D	MSL3	3,000	Green
TPR3533-S3TR	-40 to 125°C	SOT23G-3	R3E	MSL3	3,000	Green
TPR3540-S3TR	-40 to 125°C	SOT23G-3	R3F	MSL3	3,000	Green

(1) Green: 3PEAK defines "Green" to mean RoHS compatible and free of halogen substances.

 **3PEAK and the 3PEAK logo are registered trademarks of 3PEAK INCORPORATED. All other trademarks are the property of their respective owners.**
