

**Features:**

- n Isolated mounting base 2500V~
- n Solder joint technology with
Increased power cycling capability
- n Space and weight saving

Typical Applications

- n Inverter
- n Inductive heating
- n Chopper

V_{RRM}	Type & Outline
800V	MDS175-08-234H5
1000V	MDS175-10-234H5
1200V	MDS175-12-234H5
1400V	MDS175-14-234H5
1600V	MDS175-16-234H5
1800V	MDS175-18-234H5

SYMBOL	CHARACTERISTIC	TEST CONDITIONS	$T_j(^{\circ}\text{C})$	VALUE			UNIT
				Min	Type	Max	
I_O	DC output current	Three-phase full wave rectifying circuit, $T_C=100^{\circ}\text{C}$	150			175	A
I_{RRM}	Repetitive peak current	at V_{RRM}	150			12	mA
I_{FSM}	Surge forward current	10ms half sine wave	150			1.4	kA
I^2t	I^2t for fusing coordination	$V_R=0$				9.8	$10^3\text{A}^2\text{s}$
V_{FO}	Threshold voltage		150			0.75	V
r_F	Forward slope resistance					2.2	mW
V_{FM}	Peak forward voltage	$I_{FM}=175\text{A}$	25			1.45	V
$R_{th(j-c)}$	Thermal resistance Junction to case	Single side cooled, per total				0.12	$^{\circ}\text{C}/\text{W}$
$R_{th(c-h)}$	Thermal resistance case to heatsink	Single side cooled, per total				0.07	$^{\circ}\text{C}/\text{W}$
V_{iso}	Isolation voltage	50Hz, R.M.S, $t=1\text{min}$, $I_{iso}=1\text{mA}(\text{max})$		2500			V
F_m	Terminal connection torque(M6)			4.5		6.0	N·m
	Mounting torque(M6)			4.5		6.0	N·m
T_{vj}	Junction temperature			-40		150	$^{\circ}\text{C}$
T_{stg}	Stored temperature			-40		125	$^{\circ}\text{C}$
W_t	Weight				240		g
Outline	234H5						

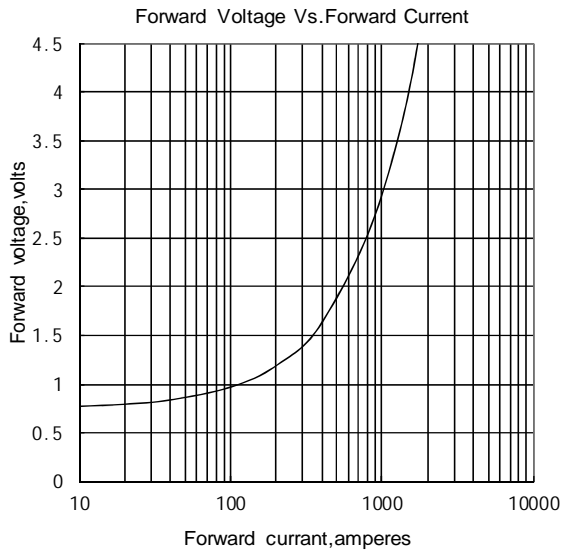

Fig.1

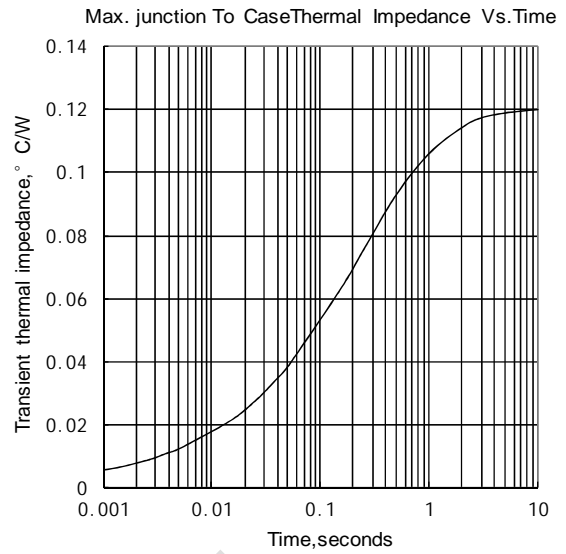

Fig.2

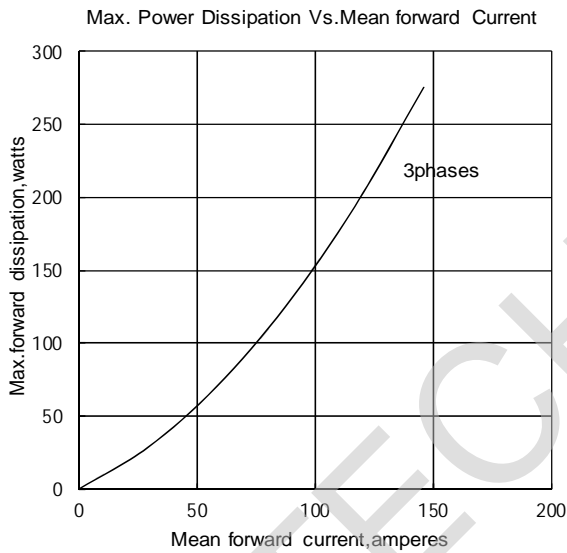

Fig.3

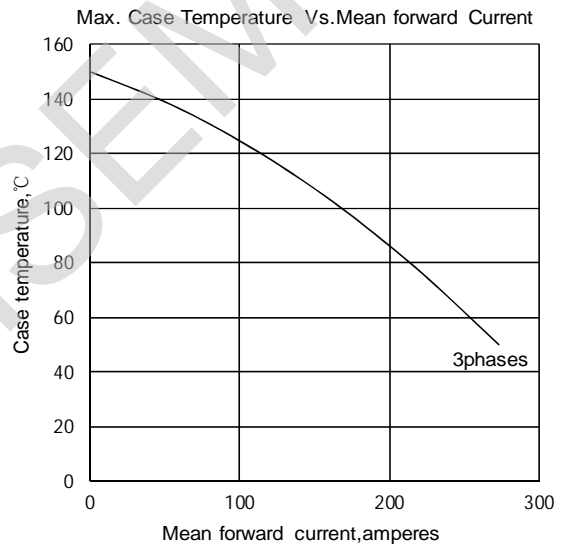

Fig.4

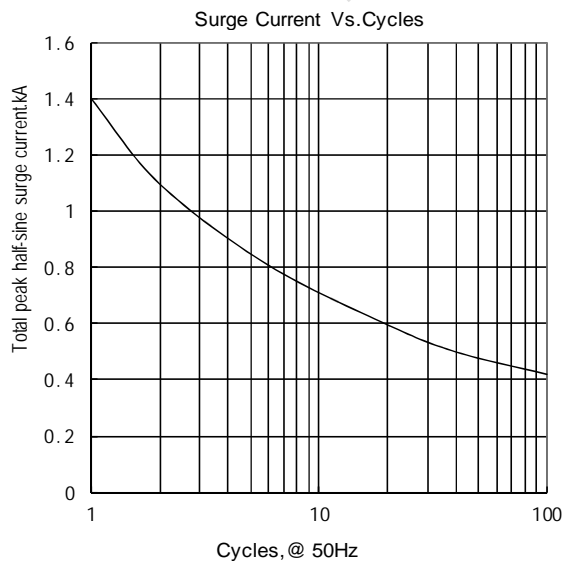

Fig.5

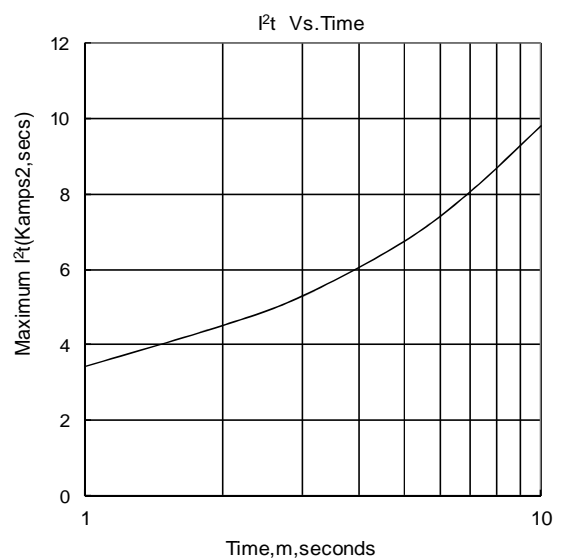
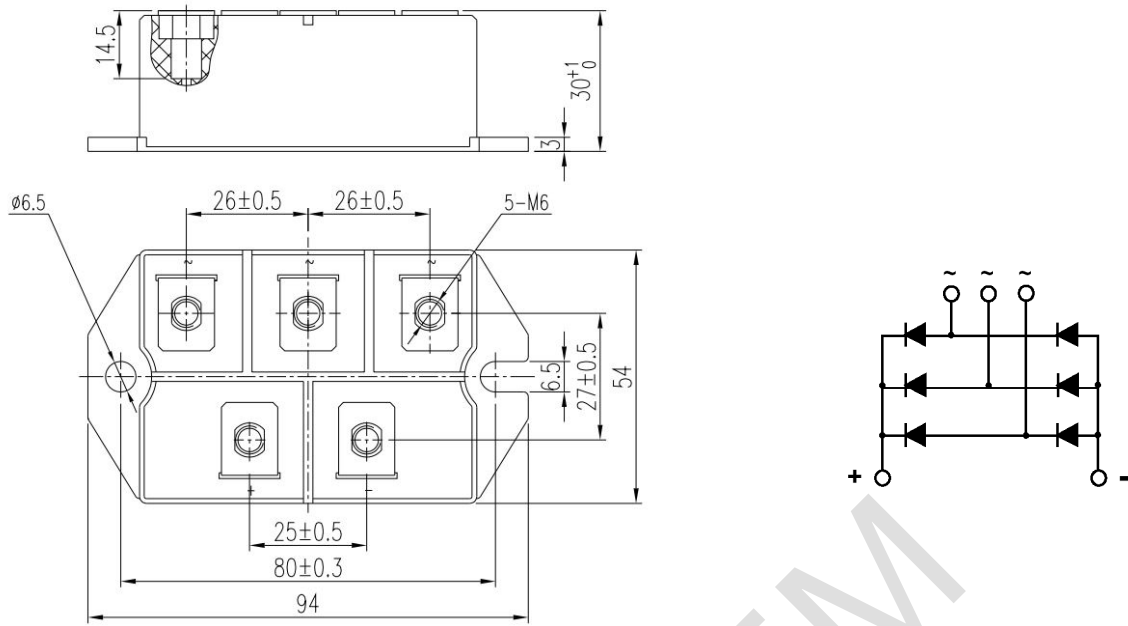

Fig.6

Outline:



Unmarked dimensional tolerance: $\pm 0.5\text{mm}$

TECHSEM