

Product Overview

NSM2011 is an integrated path current sensor with a very low on-resistance of 0.85mΩ, reducing heat loss on the chip.

NOVOSENSE innovative isolation technology and signal conditioning design can meet high isolation levels while sensing the current flowing through the internal Busbar. A differential Hall pair is used internally, so it has a strong immunity to external stray magnetic fields.

NSM2011 senses the magnetic field generated by the Busbar current flowing under the chip to indirectly detect the current. Compared with the current sampling method of the Shunt+ isolated op amp, NSM2011 eliminates the need for the primary side power supply and has a simple and convenient layout. At the same time, it has extremely high isolation withstand voltage and Lifetime stability.

In high-side current monitoring applications, NSM2011 can reach a working voltage of 1550Vpk, and it can withstand 10kV surge voltage and 13kA surge current without adding any protection devices.

Due to NSM2011 internal accurate temperature compensation algorithm and factory accuracy calibration, this current sensor can maintain good accuracy in the full temperature working range, and the customer does not need to do secondary programming or calibration.

Support 3.3V/5V power supply (different version)

Key Features

- High bandwidth and fast response time
- 240kHz bandwidth
- 2.2us response time
- High-precision current measurement
- Differential Hall sets can immune stray field
- High isolation level that meets UL standards
- Maximum repeated isolation withstand voltage (VIROM): 1550Vpk
- Maximum working isolation withstand voltage (VIOWM): 1097Vrms
- Withstand isolation voltage (VISO): 5000Vrms

- Maximum surge isolation withstand voltage (VIOSM): 10kV
- Maximum surge current (Isurge): 13kA
- CMTI > 100V/ns
- CTI (I)
- Creepage distance/Clearance distance: 8mm
- An external capacitor on the Filter pin can reduce noise (sacrificing bandwidth)
- NOVOSENSE innovative 'Spin Current' technology makes offset temperature drift very small
- Ratiometric output
- Working temperature: -40°C ~ 125°C
- Primary internal resistance: 0.85mΩ
- Wide body SOIC16 package
- UL62368/EN62368 safety certification
- ROHS



Applications

- Solar system
- Industrial power supply
- Motor control
- OBC/DCDC/PTC Heater
- Charging pile

Device Information

Part Number	Package	Body Size
NSM2011	WB SOIC16	10.30mm × 7.50mm

Functional Block Diagrams

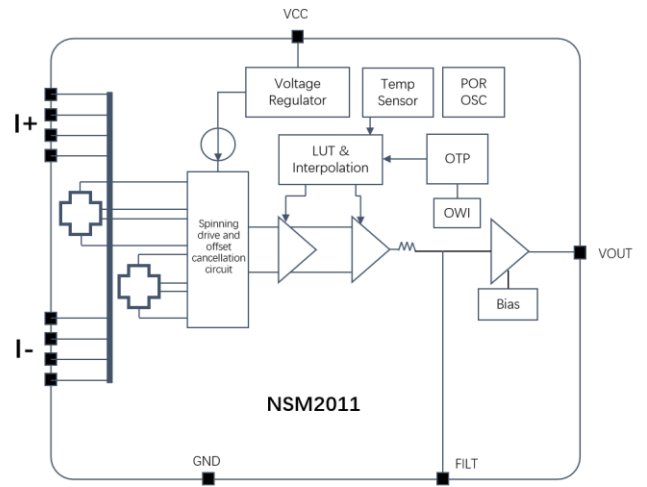

Figure 1. NSM2011 Block Diagram

INDEX

1. PIN CONFIGURATION AND FUNCTIONS	4
2. ABSOLUTE MAXIMUM RATINGS.....	5
3. ISOLATION CHARACTERISTICS	5
4. SPECIFICATIONS	6
4.1. COMMON CHARACTERISTICS (TA= -40°C TO 125°C, VCC = 5V OR 3.3V, UNLESS OTHERWISE SPECIFIED).....	6
4.2. NSM2011-20B5R-DSWR CHARACTERISTICS (TA= -40°C TO 125°C, VCC = 5V, UNLESS OTHERWISE SPECIFIED).....	7
4.3. NSM2011-30B5R-DSWR CHARACTERISTICS (TA= -40°C TO 125°C, VCC = 5V, UNLESS OTHERWISE SPECIFIED).....	7
4.4. NSM2011-50B5R-DSWR CHARACTERISTICS (TA= -40°C TO 125°C, VCC = 5V, UNLESS OTHERWISE SPECIFIED).....	8
4.5. NSM2011-65B3R-DSWR CHARACTERISTICS (TA= -40°C TO 125°C, VCC = 3.3V, UNLESS OTHERWISE SPECIFIED).....	9
4.6. NSM2011-65B5R-DSWR CHARACTERISTICS (TA= -40°C TO 125°C, VCC = 5V, UNLESS OTHERWISE SPECIFIED).....	9
4.7. TYPICAL PERFORMANCE CHARACTERISTICS.....	11
NSM2011-20B5R-DSWR ^[1]	11
NSM2011-30B5R-DSWR ^[1]	11
NSM2011-50B5R-DSWR ^[1]	12
NSM2011-65B3R-DSWR ^[1]	13
NSM2011-65B5R-DSWR ^[1]	13
5. FUNCTION DESCRIPTION	16
5.1. OVERVIEW	16
5.2. NSM2011 R VERSION(SINGLE-ENDED RATIOMETRIC OUTPUT)	16
5.3. DEFINITION OF NSM2011 TERMS	16
6. APPLICATION NOTE	19
6.1. TYPICAL APPLICATION CIRCUIT	19
6.2. PCB LAYOUT.....	19
6.3. THERMAL EVALUATION	20
7. PACKAGE INFORMATION.....	21
8. ORDER INFORMATION	22
9. TAPE AND REEL INFORMATION	23
10. REVISION HISTORY	24

1. Pin Configuration and Functions

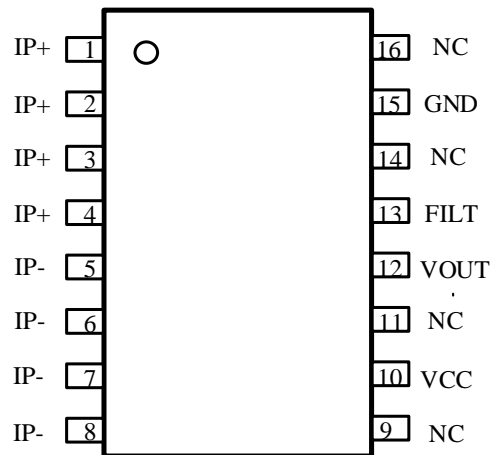

Figure 1.1 NSM2011 Package

Table 1.1 NSM2011 Pin Configuration and Description

NSM2011 PIN NO.	SYMBOL	FUNCTION
1-4	IP+	Current flows into the chip, positive direction
5-8	IP-	Current flows out of the chip, negative direction
9	NC	Not connection (this Pin can also connect to GND)
10	VCC	Power supply
11	NC	Not connection (Internal circuit connection, this Pin can also connect to GND)
12	VOUT	Output voltage
13	FILT	Filter Pin, decrease bandwidth to limit noise (construct a low-pass filter with internal 4.7K resistor)
14	NC	Not connection (Internal circuit connection, this Pin can also connect to GND)
15	GND	Ground
16	NC	Not connection (Internal circuit connection, this Pin can also connect to GND)

2. Absolute Maximum Ratings

Parameters	Symbol	Min	Typ	Max	Unit	Comments
V _{CC}	V _{CC}	-0.3		6.5	V	25°C
V _{out} /V _{ref}		-0.3		VDD+0.3	V	25°C
Others Pin		-0.3		VDD+0.3	V	25°C
Storage temperature	T _{Storage}	-40		150	°C	
Ambient temperature	T _{operation}	-40		125	°C	
Junction temperature	T _J	-40		150	°C	
ESD	V _{HBM}		±8		kV	
	V _{CDM}		±2		kV	
	Latch-up		±500		mA	

3. Isolation Characteristics

Parameters	Symbol	Rating	Unit	Comments
Surge Voltage	V _{surge}	10	kV	Based on IEC61000-4-5 1.2us/50us waveform
Surge Current	I _{surge}	13	kA	Based on IEC61000-4-5 8us/20us waveform
Dielectric Strength Test Voltage	V _{iso}	5000	V _{rms}	60s dielectric strength test voltage, in accordance with UL62368-1, production tested at 6kV for 1 second
Working Voltage for Basic Isolation	V _{WVBI}	1097	V _{rms}	Maximum approved working voltage for basic isolation according to UL60950-1 and UL62368-1
		1550	V _{dc}	
Common-mode transient immunity	CMTI	>100	V/ns	The criterion for judging the failure is that the output peak is greater than 100mV and the duration is longer than 1us
Creepage	Creepage	8	mm	Minimum Creepage
Clearance	Clearance	8	mm	Minimum Clearance
Comparative Tracking Index	CTI	>=600		CTI 1

4. Specifications

4.1. Common Characteristics (TA= -40°C to 125°C, VCC = 5V or 3.3V, unless otherwise specified)

Parameters	Symbol	Min	Typ	Max	Unit	Comments
Supply voltage	V _{CC}	3	3.3	3.6	V	3.3V version
		4.5	5	5.5	V	5V version
Supply current	I _{CC}		10	15	mA	No load, V _{CC} =5V, 'R' version
			7.5	8	mA	No load, V _{CC} =3.3V, 'R' version
Primary conductor resistance	R _P		0.85		mΩ	T _A = 25°C
Internal filter resistance ^[1]	R _{filter}		4.7		kΩ	
Power-on time	T _{po}		1		ms	Recommend customer to read output after 1ms power-on time, before 1ms internal OTP is loading, T _A = 25°C
Output capacitance load ^{[1][2]}	C _L			10	nF	
Output resistance load ^{[1][2]}	R _L	10			kΩ	
Output short current	I _{short}		25		mA	Short to VCC and short to GND, T _A = 25°C
Rail to Rail output voltage ^{[1][2]}	V _s	0.1		VCC-0.1	V	T _A = 25°C, C _L =1nF, R _L =10K to VCC or GND
Common mode field rejection ^{[1][2]}	CMFR		>40		dB	
Rise time ^{[1][2]}	T _r		1.2		us	V _{out} =3V, T _A = 25°C, C _L =1nF, VCC=5V, 30A, R version
Propagation delay ^{[1][2]}	T _{pd}		1.2		us	V _{out} =3V, T _A = 25°C, C _L =1nF, VCC=5V, 30A, R version
Response time ^{[1][2]}	T _{response}		2.2		us	V _{out} =3V, T _A = 25°C, C _L =1nF, VCC=5V, 30A, R version
Bandwidth ^{[1][2]}	BW		240		kHz	-3dB bandwidth, T _A = 25°C, C _L =1nF, VCC=5V, 30A, R version
Noise density ^{[1][2]}	ND		260		uArms/ √Hz	T _A = 25°C, C _L =1nF, VCC= 5V
			370		uArms/ √Hz	T _A = 25°C, C _L =1nF, VCC= 3.3V
Non-linearity	E _{NL}		±0.2		%	
Ratiometric output sensitivity error	S _{ERR}		0.75		%	'R' version, V _{CC} = 4.85V~5.15V, T _A = 25°C
Ratiometric output offset error	V _{OUTOR}		0.1		%	'R' version, V _{CC} = 4.85V~5.15V, T _A = 25°C

Parameters	Symbol	Min	Typ	Max	Unit	Comments
Ratiometric output zero current output voltage	QVO		$V_{CC}/2$			'RB' version
			$0.1 \cdot V_{CC}$			'RU' version

[1]: Design by Guarantee

[2]: Guaranteed by Bench Validation

[3]: The increase or decrease of data in 4.X will not send a PCN to the customer if the evaluation does not affect the customer's use.

4.2. NSM2011-20B5R-DSWR Characteristics (TA= -40°C to 125°C, VCC = 5V, unless otherwise specified)

Parameters	Symbol	Min	Typ	Max	Unit	Comments
Current sensing range	I_{pr}	-20		20	A	
Sensitivity	Sens		100		mV/A	$I_{prmin} < I_{pr} < I_{prmax}$
Zero current output voltage	V_{QVO}		$V_{CC}/2$		V	$I_{pr}=0A$
Sensitivity error ^[1]	E_{sens}	-1.5		1.5	%	TA = 25°C~125°C
			±2.5		%	TA = -40°C~25°C
Offset error	V_{OE}	-10		10	mV	TA = 25°C~125°C, $I_{pr}=0A$
			±15		mV	TA = -40°C~25°C, $I_{pr}=0A$
Total output error ^[1]	E_{total}	-1.5		1.5	%	TA = 25°C~125°C
			±2.5		%	TA = -40°C~25°C
Sensitivity error lifetime drift ^{[2][3]}	E_{sens_drift}		±1.7		%	After reliability test, TA = 25°C
Offset lifetime drift ^{[2][3]}	V_{OE_drift}		±4		mV	After reliability test, TA = 25°C
Total output error lifetime drift ^{[2][3]}	E_{total_drift}		±1.8		%	After reliability test, TA = 25°C

[1]: In production, total error and sensitivity error are measured and calculated at 20A, A single part will not have both the maximum/minimum sensitivity error and maximum/minimum offset voltage.

[2]: When TA = 25°C~125°C, Min/Max value is the mean value +/-3sigma; When TA = -40°C~25°C, Typical value is the mean value +/-3sigma according to the statistical law, 99.73% of the data is in this range inside.

[3]: The reliability data is implemented in accordance with the AEC-Q100 standard. This item is derived from the experimental results with the largest change after the PC, HTS, HAST, UHAST, HTOL, TC and other test data required by AEC-Q100 Grade1 as a reference. , Is the worst case.

4.3. NSM2011-30B5R-DSWR Characteristics (TA= -40°C to 125°C, VCC = 5V, unless otherwise specified)

Parameters	Symbol	Min	Typ	Max	Unit	Comments
Current sensing range	I_{pr}	-30		30	A	
Sensitivity	Sens		66.67		mV/A	$I_{prmin} < I_{pr} < I_{prmax}$
Zero current output voltage	V_{QVO}		$V_{CC}/2$		V	$I_{pr}=0A$
Sensitivity error ^[1]	E_{sens}	-1		1	%	TA = 25°C~125°C
			±2.5		%	TA = -40°C~25°C

Offset error	V_{OE}	-10		10	mV	TA = 25°C~125°C, $I_{pr}=0A$
			±10		mV	TA = -40°C~25°C, $I_{pr}=0A$
Total output error ^[1]	E_{total}	-1		1	%	TA = 25°C~125°C
			±2.5			TA = -40°C~25°C
Sensitivity error lifetime drift ^{[2][3]}	E_{sens_drift}		±1.7		%	After reliability test, TA = 25°C
Offset lifetime drift ^{[2][3]}	V_{OE_drift}		±4		mV	After reliability test, TA = 25°C
Total output error lifetime drift ^{[2][3]}	E_{total_drift}		±1.8		%	After reliability test, TA = 25°C

[1]: In production, total error and sensitivity error are measured and calculated at 30A, A single part will not have both the maximum/minimum sensitivity error and maximum/minimum offset voltage.

[2]: When TA = 25°C~125°C, Min/Max value is the mean value +/-3sigma; When TA = -40°C~25°C, Typical value is the mean value +/-3sigma. according to the statistical law, 99.73% of the data is in this range inside.

[3]: The reliability data is implemented in accordance with the AEC-Q100 standard. This item is derived from the experimental results with the largest change after the PC, HTS, HAST, UHAST, HTOL, TC and other test data required by AEC-Q100 Grade1 as a reference. , Is the worst case.

4.4. NSM2011-50B5R-DSWR Characteristics (TA= -40°C to 125°C, VCC = 5V, unless otherwise specified)

Parameters	Symbol	Min	Typ	Max	Unit	Comments
Current sensing range	I_{pr}	-50		50	A	
Sensitivity	Sens		40		mV/A	$I_{prmin}<I_{pr}<I_{prmax}$
Zero current output voltage	V_{QVO}		$V_{CC}/2$		V	$I_{pr}=0A$
Sensitivity error ^[1]	E_{sens}	-2		2	%	TA = 25°C~125°C
			±2		%	TA = -40°C~25°C
Offset error	V_{OE}	-10		10	mV	TA = 25°C~125°C, $I_{pr}=0A$
			±10		mV	TA = -40°C~25°C, $I_{pr}=0A$
Total output error ^[1]	E_{total}	-2		2	%	TA = 25°C~125°C
			±2			TA = -40°C~25°C
Sensitivity error lifetime drift ^{[2][3]}	E_{sens_drift}		±1.7		%	After reliability test, TA = 25°C
Offset lifetime drift ^{[2][3]}	V_{OE_drift}		±4		mV	After reliability test, TA = 25°C
Total output error lifetime drift ^{[2][3]}	E_{total_drift}		±1.8		%	After reliability test, TA = 25°C

[1]: In production, total error and sensitivity error are measured and calculated at 30A, A single part will not have both the maximum/minimum sensitivity error and maximum/minimum offset voltage.

[2]: When TA = 25°C~125°C, Min/Max value is the mean value +/-3sigma; When TA = -40°C~25°C, Typical value is the mean value +/-3sigma. according to the statistical law, 99.73% of the data is in this range inside.

[3]: The reliability data is implemented in accordance with the AEC-Q100 standard. This item is derived from the experimental results with the largest change after the PC, HTS, HAST, UHAST, HTOL, TC and other test data required by AEC-Q100 Grade1 as a reference. , Is the worst case.

4.5. NSM2011-65B3R-DSWR Characteristics (TA= -40°C to 125°C, VCC = 3.3V, unless otherwise specified)

Parameters	Symbol	Min	Typ	Max	Unit	Comments
Current sensing range	I_{pr}	-65		65	A	
Sensitivity	Sens		20.31		mV/A	$I_{prmin} < I_{pr} < I_{prmax}$
Zero current output voltage	V_{QVO}		$V_{CC}/2$		V	$I_{pr}=0A$
Sensitivity error ^[1]	E_{sens}	-2		2	%	TA = 25°C~125°C
			±3		%	TA = -40°C~25°C
Offset error	V_{OE}	-5		5	mV	TA = 25°C~125°C, $I_{pr}=0A$
			±5		mV	TA = -40°C~25°C, $I_{pr}=0A$
Total output error ^[1]	E_{total}	-2		2	%	TA = 25°C~125°C
			±3			TA = -40°C~25°C
Sensitivity error lifetime drift ^{[2][3]}	E_{sens_drift}		±1.7		%	After reliability test, TA = 25°C
Offset lifetime drift ^{[2][3]}	V_{OE_drift}		±4		mV	After reliability test, TA = 25°C
Total output error lifetime drift ^{[2][3]}	E_{total_drift}		±1.8		%	After reliability test, TA = 25°C

[1]: In production, total error and sensitivity error are measured and calculated at 30A, A single part will not have both the maximum/minimum sensitivity error and maximum/minimum offset voltage.

[2]: When TA = 25°C~125°C, Min/Max value is the mean value +/-3sigma; When TA = -40°C~25°C, Typical value is the mean value +/-3sigma according to the statistical law, 99.73% of the data is in this range inside.

[3]: The reliability data is implemented in accordance with the AEC-Q100 standard. This item is derived from the experimental results with the largest change after the PC, HTS, HAST, UHAST, HTOL, TC and other test data required by AEC-Q100 Grade1 as a reference. , Is the worst case.

4.6. NSM2011-65B5R-DSWR Characteristics (TA= -40°C to 125°C, VCC = 5V, unless otherwise specified)

Parameters	Symbol	Min	Typ	Max	Unit	Comments
Current sensing range	I_{pr}	-65		65	A	
Sensitivity	Sens		30.77		mV/A	$I_{prmin} < I_{pr} < I_{prmax}$
Zero current output voltage	V_{QVO}		$V_{CC}/2$		V	$I_{pr}=0A$
Sensitivity error ^[1]	E_{sens}	-2		2	%	TA = 25°C~125°C
			±3.5		%	TA = -40°C~25°C
Offset error	V_{OE}	-10		10	mV	TA = 25°C~125°C, $I_{pr}=0A$
			±10		mV	TA = -40°C~25°C, $I_{pr}=0A$
Total output error ^[1]	E_{total}	-2		2	%	TA = 25°C~125°C
			±3.5			TA = -40°C~25°C
Sensitivity error lifetime drift ^{[2][3]}	E_{sens_drift}		±1.7		%	After reliability test, TA = 25°C

Offset lifetime drift ^{[2][3]}	V _{OE_drift}		±4		mV	After reliability test, TA = 25 °C
Total output error lifetime drift ^{[2][3]}	E _{total_drift}		±1.8		%	After reliability test, TA = 25 °C

[1]: In production, total error and sensitivity error are measured and calculated at 30A, A single part will not have both the maximum/minimum sensitivity error and maximum/minimum offset voltage.

[2]: When TA = 25 °C~125 °C, Min/Max value is the mean value +/-3sigma; When TA = -40 °C~25 °C, Typical value is the mean value +/-3sigma. according to the statistical law, 99.73% of the data is in this range inside.

[3]: The reliability data is implemented in accordance with the AEC-Q100 standard. This item is derived from the experimental results with the largest change after the PC, HTS, HAST, UHAST, HTOL, TC and other test data required by AEC-Q100 Grade1 as a reference. , Is the worst case.

*In the fourth chapter, the increase or decrease of the material number and the tightening of the parameter range, Novosense reserves the right not to send PCN to the customer, unless the expansion of the parameter range affects the customer's use and product performance.

4.7. Typical Performance Characteristics

NSM2011-20B5R-DSWR^[1]

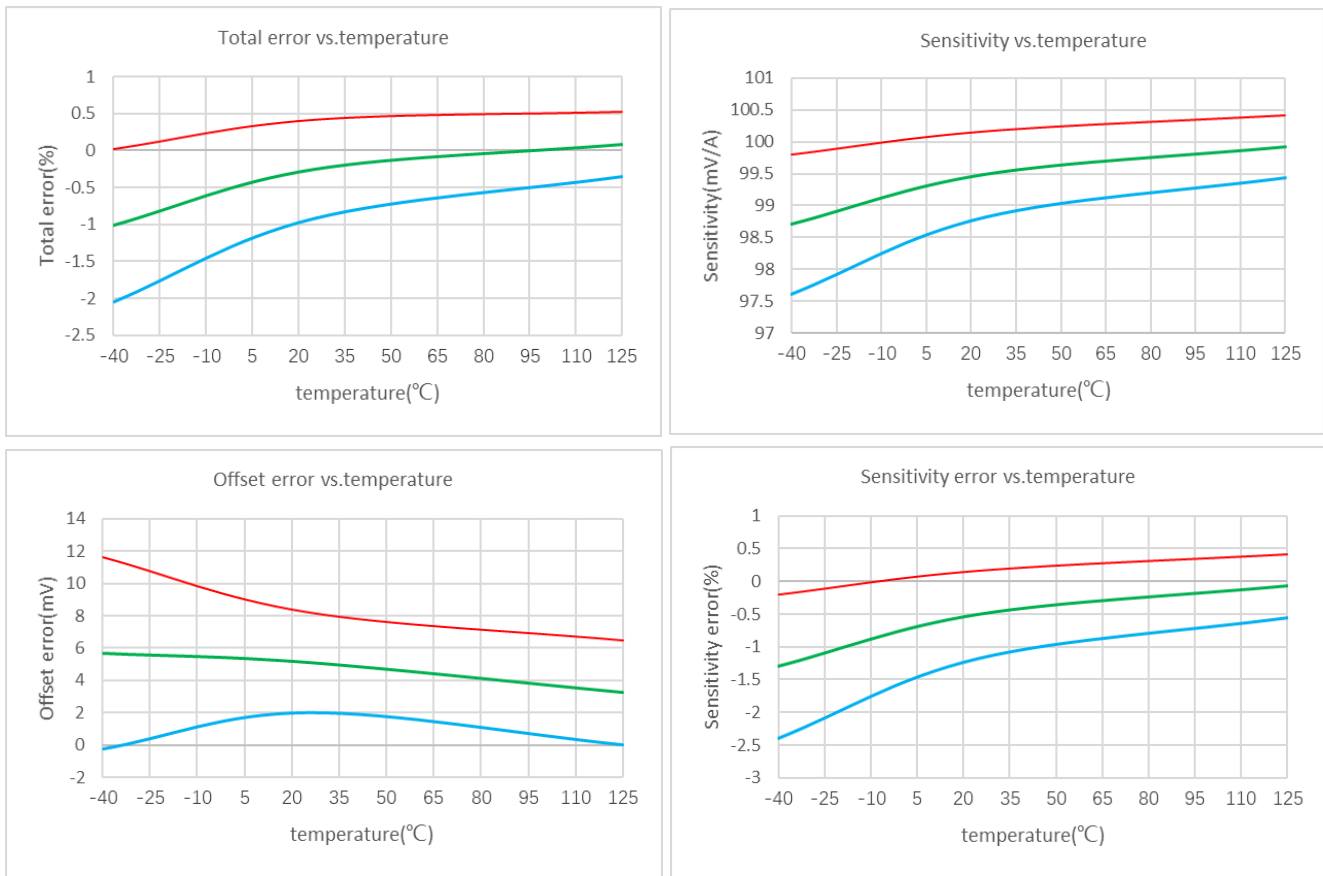

[1] : Green represents the average value, the red line represents the average value + 3 Sigma, and the blue line represents the average value-3 Sigma

NSM2011-30B5R-DSWR^[1]

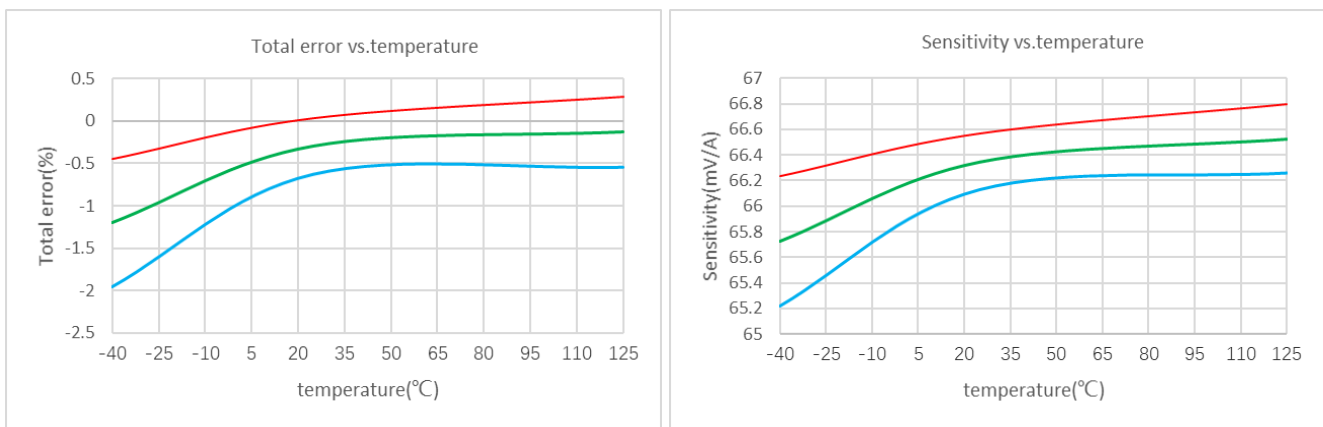

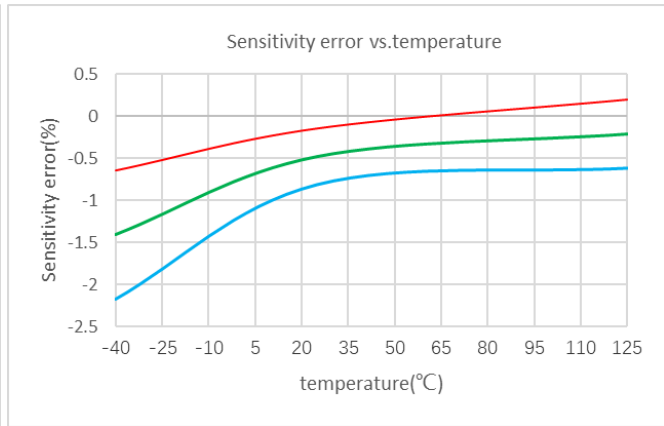
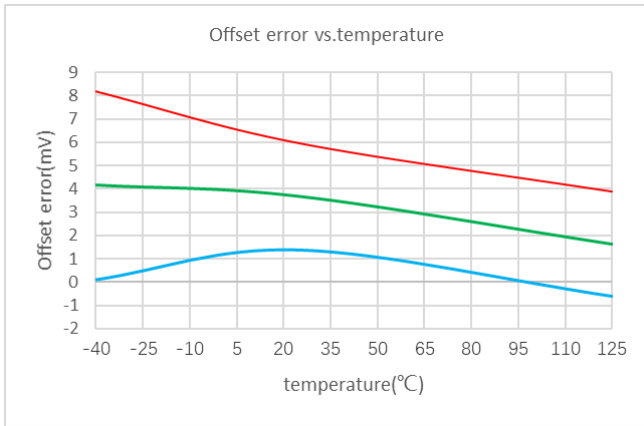

[1] : Green represents the average value, the red line represents the average value + 3 Sigma, and the blue line represents the average value-3 Sigma

NSM2011-50B5R-DSWR^[1]

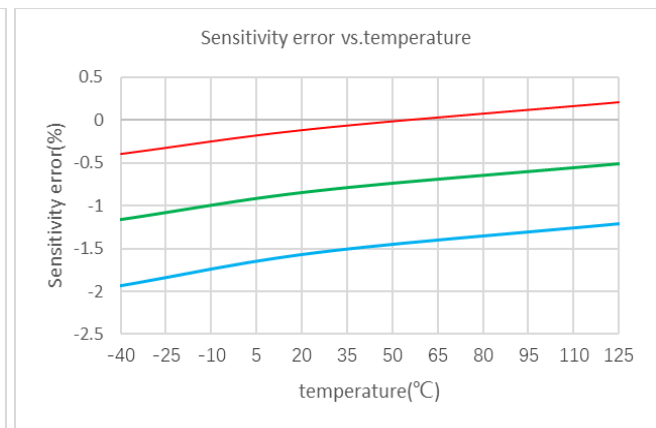
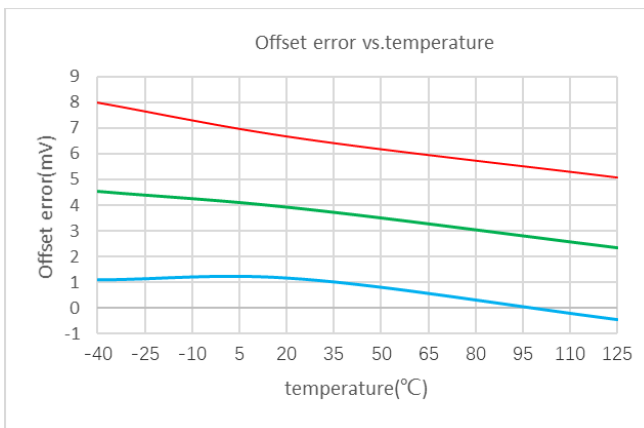
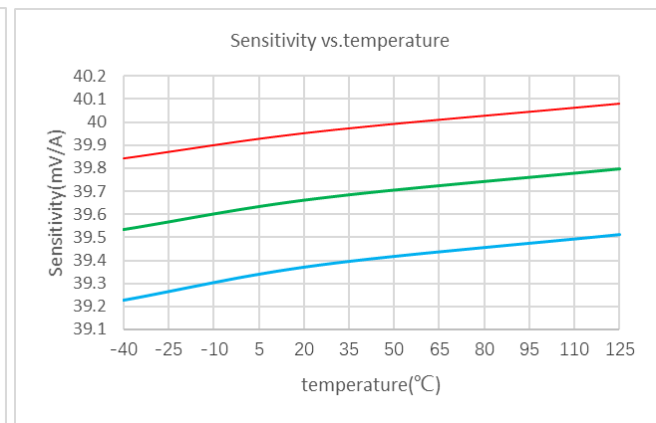
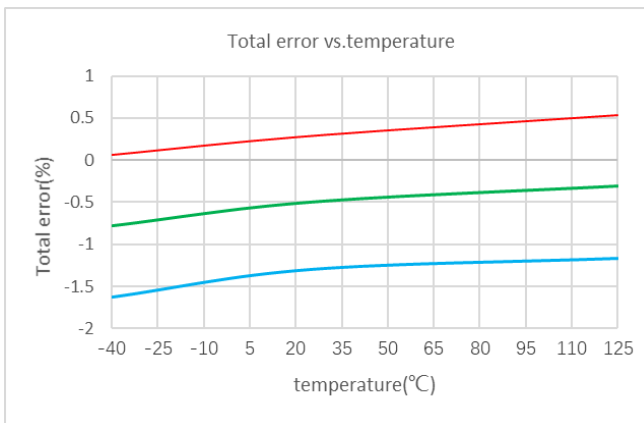

[1] : Green represents the average value, the red line represents the average value + 3 Sigma, and the blue line represents the average value-3 Sigma

NSM2011-65B3R-DSWR^[1]

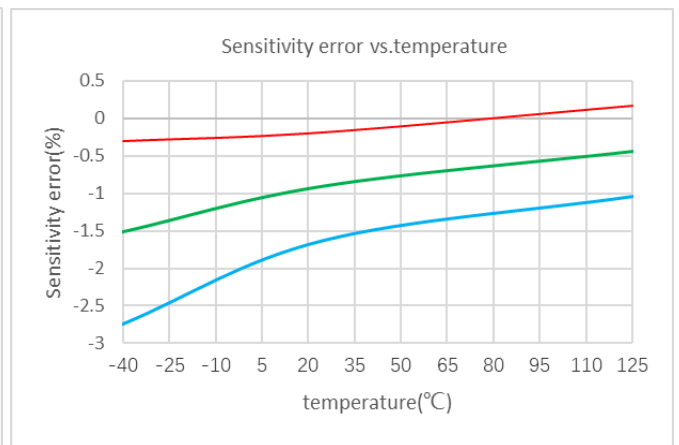
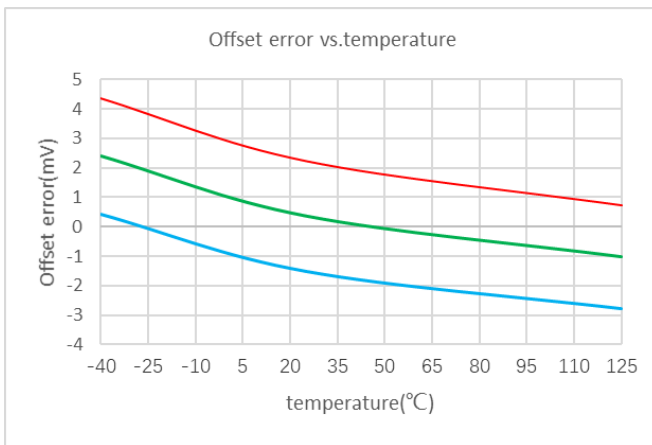
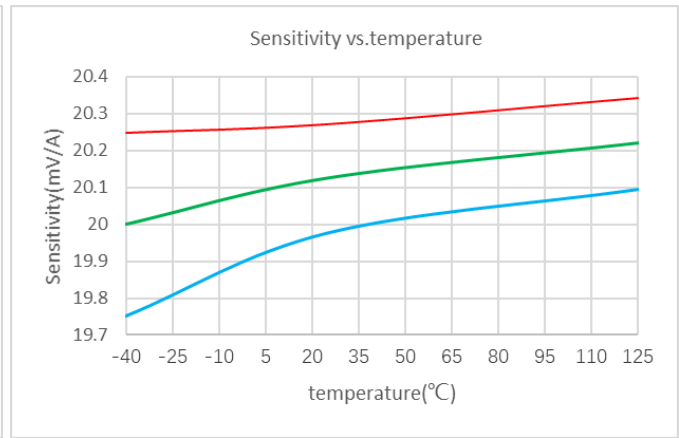
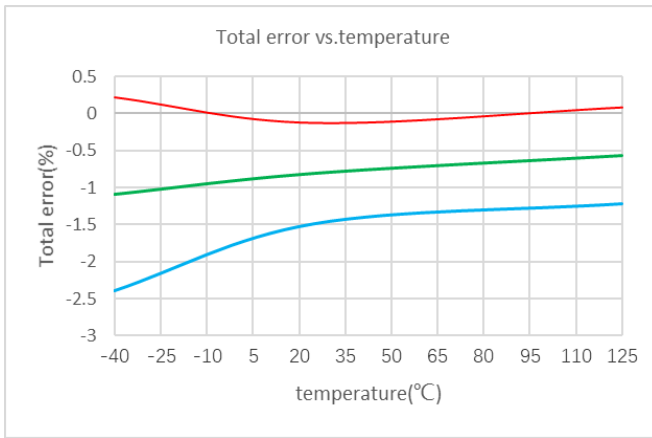

[1] : Green represents the average value, the red line represents the average value + 3 Sigma, and the blue line represents the average value-3 Sigma

NSM2011-65B5R-DSWR^[1]

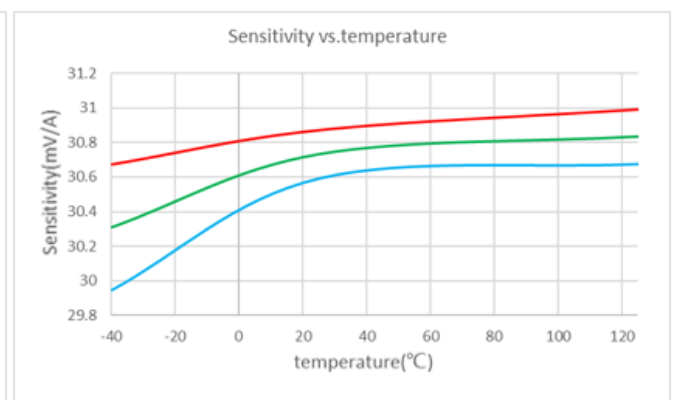
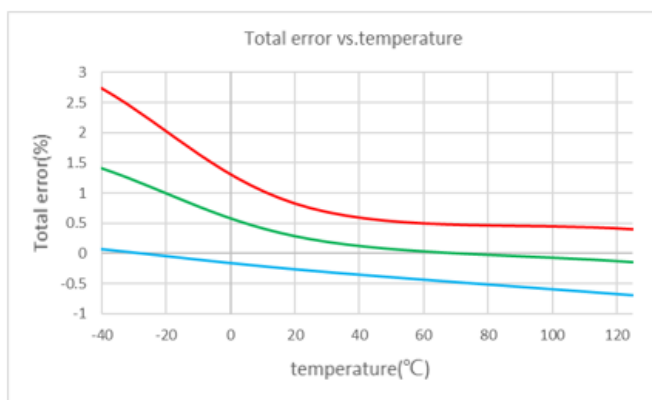

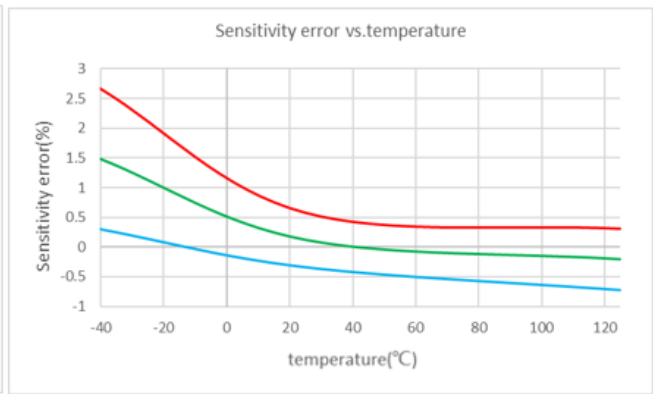
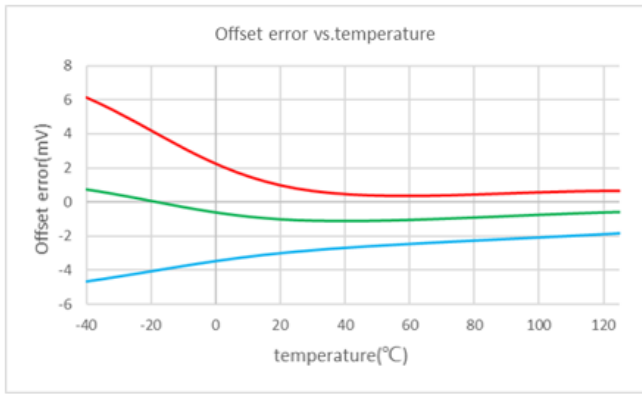

[1] : Green represents the average value, the red line represents the average value + 3 Sigma, and the blue line represents the average value-3 Sigma

Response time, Green is Vout, yellow line is step primary current

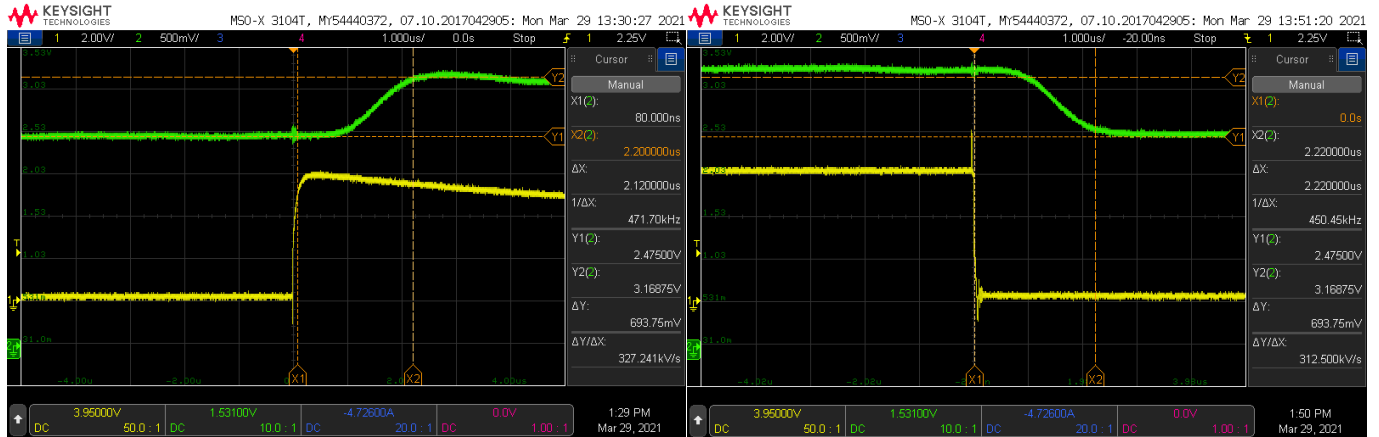

Rise time, Green is Vout, yellow line is step primary current

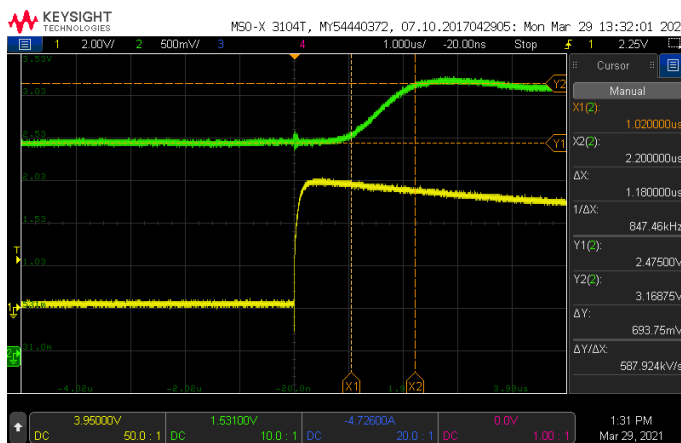

fall time, Green is Vout, yellow line is step primary current

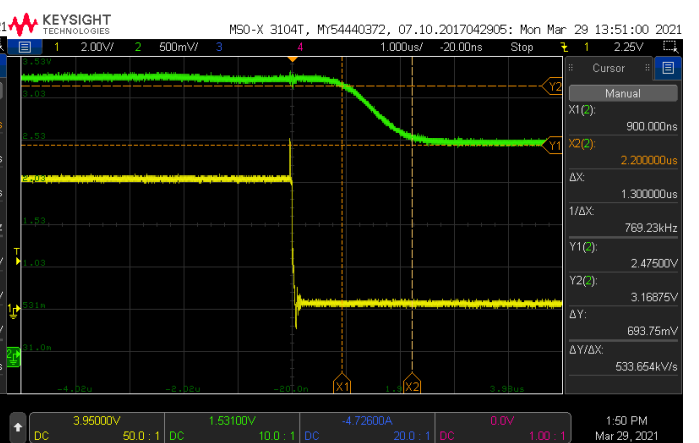

Green is Vout, yellow is 1kHz, 1A primary current

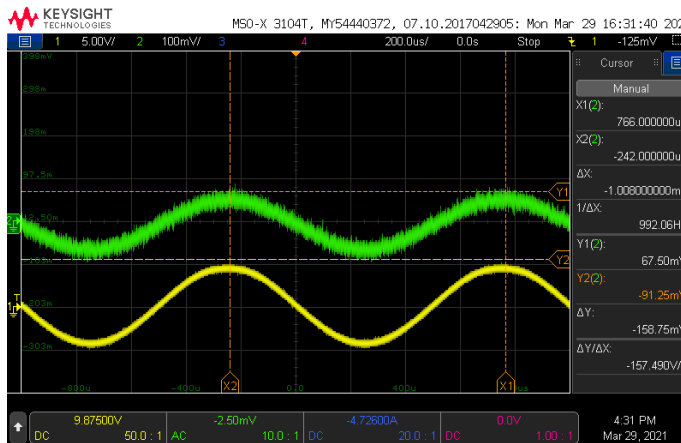

Green is Vout, yellow is 240kHz, 1A primary current

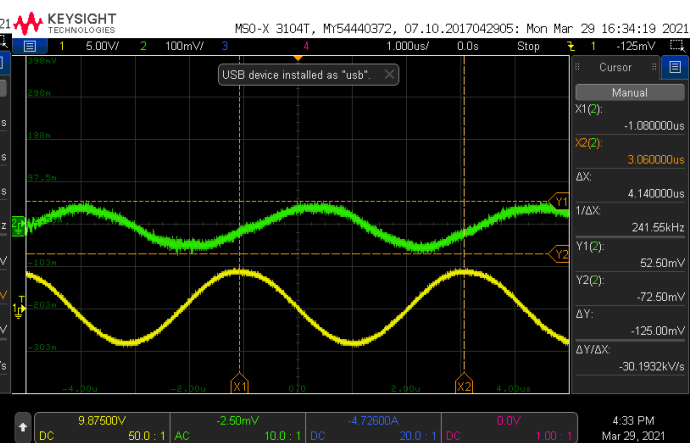

Note: Above waveform is evaluated by NSM2011-30B5R-DSWR

5. Function Description

5.1. Overview

NSM2011 current sensor can accurately measure AC/DC current while minimizing the overall measurement cost. Current sensors based on the Hall principle can be widely used in all current monitoring applications such as consumption, industry, and automotive. Compared with current transformers, the extremely small size of NSM2011 SOIC16W can help customers reduce the overall PCB area; compared to Shunt+isolated op amps, NSM2011 only needs low-voltage side power supply, reducing the inconvenience of isolated op amps requiring power supply for both high and low voltages. When using NSM2011, you only need to string the primary side pin into the measured current. According to the part of Maxwell equations about electricity and magnetism, a magnetic field will be generated around the energized conductor of the primary side. The Hall and conditioning amplifier circuits in NSM2011 will convert magnetic field into an output voltage, and the output voltage increases or decreases in proportion to the input current.

Benefiting from the typical value of the primary resistance of NSM2011 is only 0.85mohm, as long as the customer conducts a reasonable heat dissipation design, the temperature rise brought by the measurement of large current can be effectively reduced.

At the same time, NSM2011 uses dual Hall sampling internally, the common mode magnetic field brought by the outside world can be effectively reduced. According to the measured typical value, if the 100G common mode magnetic field acts vertically on the chip, it will only bring an error of less than 1G in the output. (Equivalent to input). Because NSM2011 has a good ability to resist common-mode magnetic fields, it can still maintain excellent performance in motor control or some harsh current measurement environments.

5.2. NSM2011 R version(single-ended ratiometric output)

The NSM2011 R version is a ratiometric output mode. The definition of ratiometric output is that if the power supply Vcc changes by 1% under ideal conditions, the output Vout will also change by 1% under ideal conditions. In this mode, the output calculation formula is as follows:

$$V_{out} = S_{V_{cc}} * I + QVO_{V_{cc}}$$

$S_{V_{cc}}$ is the sensitivity under the current supply voltage, and $QVO_{V_{cc}}$ is the zero point voltage of the current supply voltage, $V_{CC}/2$ (bidirectional version) or $0.1 V_{CC}$ (unidirectional version). If the customer chooses the measurement range of $\pm 20A$, then under the 5V power supply, the sensitivity is $4V/40A=100mV/A$; if the power supply voltage is changed to 4.8V, the sensitivity will become $100mV/A*4.8V/5V=96mV/A$, and the zero point voltage changes to $2.5V*4.8V/5V=2.4V$ at the same time. Due to the above proportional characteristics, the NSM2011 R version is mostly used in applications where the ADC power supply (reference) and the current sensor power supply use the same power supply.

5.3. Definition of NSM2011 terms

Power-on time (T_{po})

When the power supply climbs from 0 to the chip's working range, NSM2011 needs some time to establish the internal working logic. T_{po} time is defined as: the time from the power supply climbing to V_{ccmin} to the output reaching the steady state within $\pm 10\%$, As shown below:

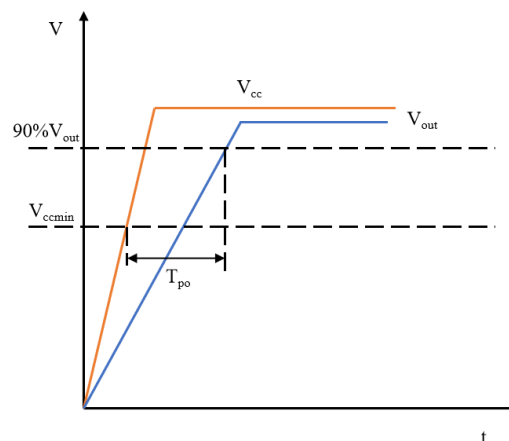

Figure 5.1 NSM2011 Power-on time

Rise time (T_r)

The time from 10% to 90% of the output signal is defined as the output rise time. For step input signals, there is such an approximate relationship between the rise time and bandwidth of the output signal: $f(-3\text{dB}) = 0.35/T_r$.

Propagation delay (T_{pd})

The time from 20% of the primary current to 20% of the output signal is defined as the output propagation delay time.

Response time (T_{response})

The time from 90% of the primary current to 90% of the output signal is defined as the output response time.

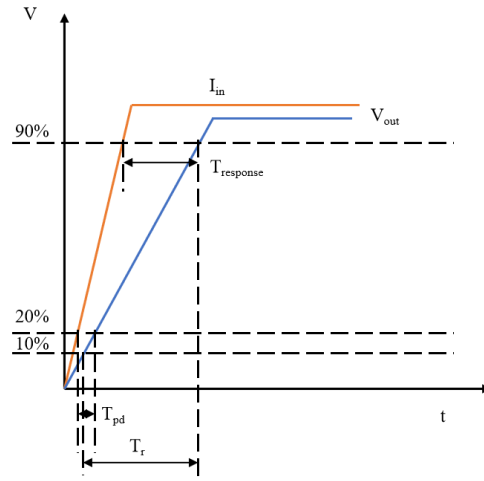

Figure 5.2 NSM2012 response time

Sensitivity and sensitivity error

Sensitivity is defined as the ratio of the output voltage proportional to the primary input current. Sensitivity is the slope of the curve in the figure below.

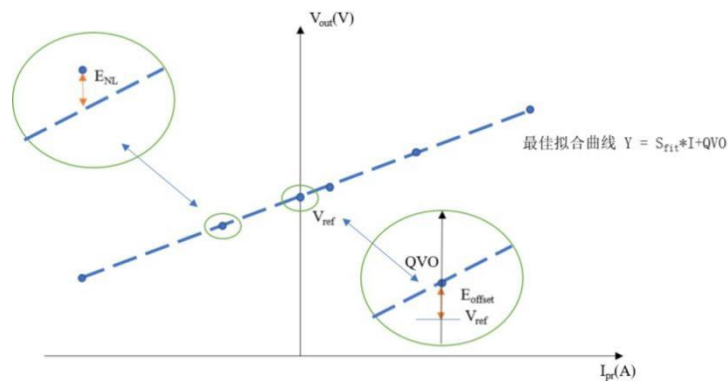

Figure 5.3 NSM2012 Sensitivity and error

The sensitivity error is defined as the deviation between the slope of the best-fit curve and the slope of the ideal curve. The slope of the best-fit curve comes from the measured value:

$$E_{\text{sens}} = \frac{(S_{\text{fit}} - S_{\text{ideal}})}{S_{\text{ideal}}} * 100\%$$

Offset error

The zero current output error is defined as the difference between the output voltage and the reference voltage when the primary current is 0A, V_{ref} here is $V_{\text{CC}}/2$ or $0.1 * V_{\text{CC}}$ (R version):

$$E_{\text{offset}} = QVO - V_{\text{ref}}$$

Nonlinear error

The linearity error is defined as the error from the maximum deviation point of the best-fit curve to the full scale. The mathematical expression is as follows:

$$V_{NL} = V_{outmax} - (S_{fit} * I_{max} + QVO)$$

among them:

V_{outmax} is the output voltage furthest from the fitted curve;

I_{max} is the primary current farthest from the fitted curve;

Therefore, the nonlinear error can be mathematically expressed as the following formula:

$$E_{NL} = \frac{V_{NL}}{FS} * 100\%$$

Total error

The total error is defined as the error between the actual given current and the current measured by the chip, in other words, the difference between the actual output voltage and the ideal output voltage. It should be known that in different current ranges, the factors that dominate the total error are different. If it is under low current measurement, the zero point error is the main source of error; if under high current measurement, the total error caused by the zero point error is very small, and the dominant error is the sensitivity error.

$$E_{total}(I_{pr}) = \frac{V_{out_{ideal}}(I_{pr}) - V_{out}(I_{pr})}{FS}$$

Ratiometric output sensitivity error

The ratiometric output sensitivity error is defined as the error of the sensitivity change with the change of V_{cc} . In a perfectly ideal situation, when V_{cc} changes by 10%, the sensitivity should also change by 10%. The error is expressed by the following formula:

$$S_{ERR} = 100\% \times \{ (S(V_{cc}) / S(5V)) - (V_{cc} / 5) \}$$

Ratiometric output offset error

The offset error of the ratiometric output is defined as the error condition of the zero point change with the change of V_{cc} . In a perfectly ideal situation, the output zero point is $V_{cc}/2$, V_{cc} changes 10%, and the zero point should also change 10%. The error is expressed by the following formula:

$$V_{OUT0R} = 100\% \times \{ (VOUT0(V_{cc}) / VOUT0(5V)) - (V_{cc} / 5) \}$$

6. Application note

6.1. Typical application circuit

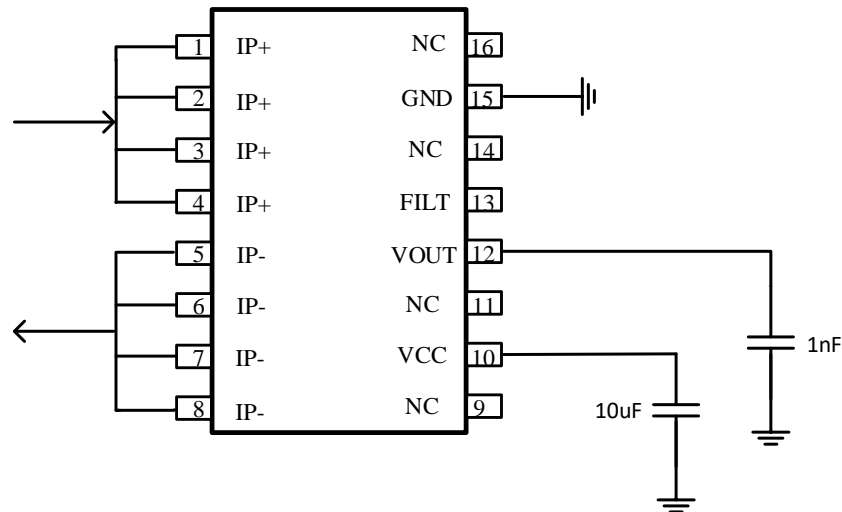

Figure 6.1 Ratiometric output typical application diagram

6.2. PCB Layout

For NSM2011 in high-current monitoring applications, a reasonable layout will make the system heat dissipation faster and better. The copper area on the NSM2011 Demo board is 21mm*18mm (very small copper area is used to illustrate the worse situation, rather than a large copper area), the top layer and the bottom layer are 2oz copper thick. Under this layout, after 30 minutes, after the 35A current stabilizes, the surface temperature of the chip is as shown in the lower right picture. The highest point temperature is around 70°C. Foreign competitors can reach 90°C under the same layout. . The reason why NSM2011 is better than competitors for heat dissipation is due to the use of packaging materials with better heat dissipation coefficients and a copper frame with better heat dissipation coefficients. If customers want to achieve better heat dissipation, they can use multi-layer boards and thicken the copper thickness to achieve it, and can use active heat dissipation solutions in the system, such as adding heat sinks and fans. If you need to use the NSM2011 Demo board to evaluate the performance of this current sensor, please contact Novosense sales team for support.

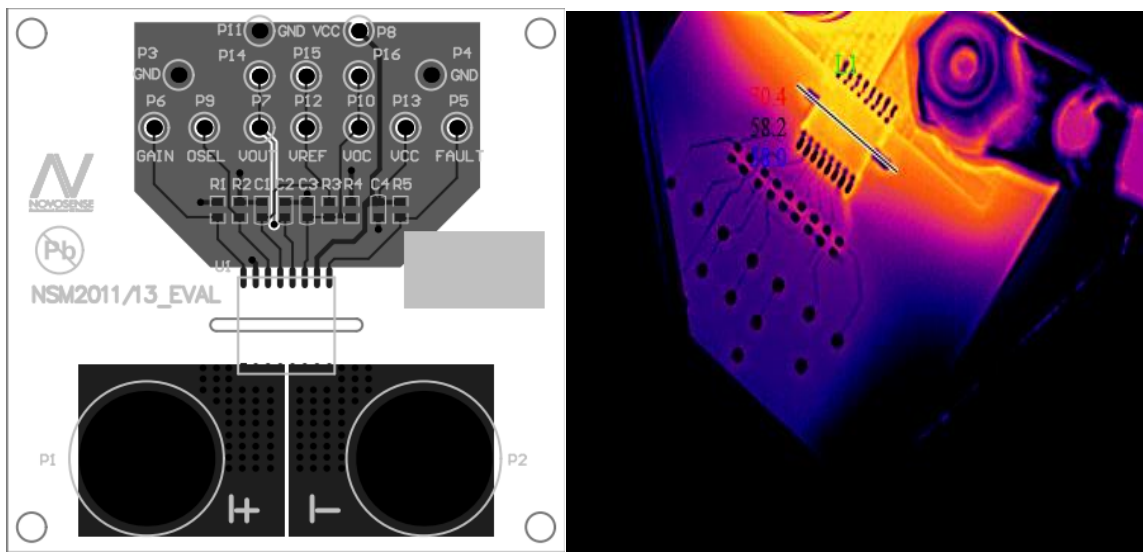

Figure 6.2 NSM2011 PCB Layout

6.3. Thermal evaluation

The thermal evaluation experiment is tested at room temperature, which mainly illustrates the temperature rise of the NSM2011 current sensor under different currents. With these data and the above-mentioned layout guide, customers can design heat dissipation according to actual application requirements. The ambient temperature in this experiment is room temperature. The surface is mounted on the above Demo board for temperature rise test. There is no external active heat dissipation device (such as a fan, etc.). The relationship between junction temperature and time is measured. 20 minutes of temperature data are collected. Under normal circumstances, the temperature rise It is basically fixed in about 10 minutes, and the specific test data are as follows:

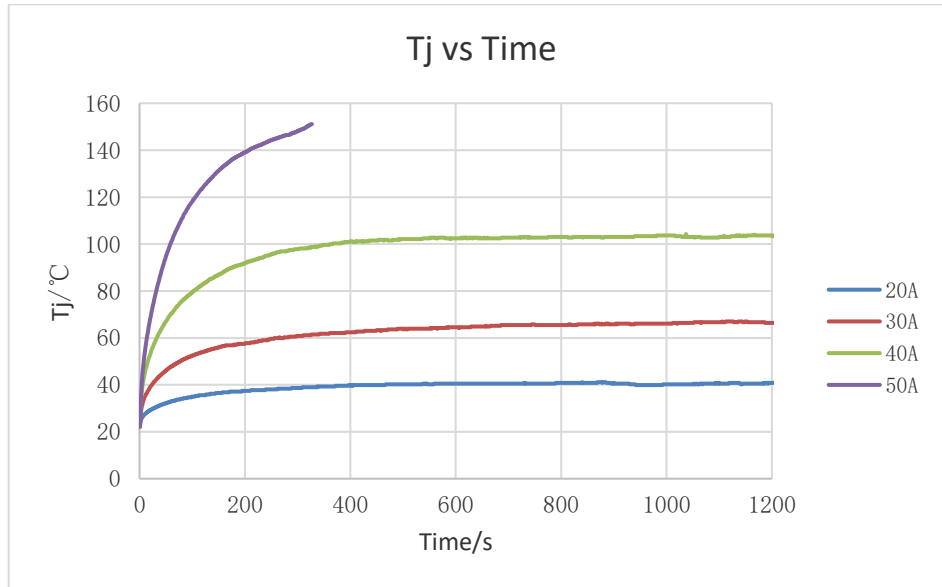

Figure 6.3 NSM2011 Junction temperature vs. Different continues current

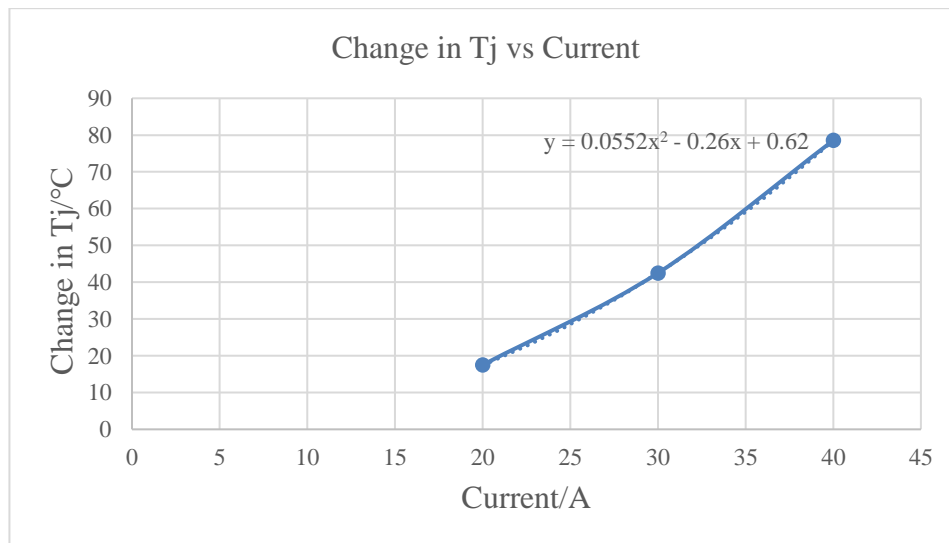

Figure 6.4 NSM2011 Estimation function of junciton temperature at different currents (PCB is in worst case)

It is important to note that the above temperature rise experiment data is only based on the Demo board, in order to reflect the relationship between NSM2011 current and temperature in a worst case. Customers can reduce the temperature rise of Tj by increasing or thickening the copper area of the PCB, using multi-layer boards, or adding active heat dissipation devices such as fans (Tj<150°C). If customers compare NSM2011 with other competing products, please refer to the same PCB design instead of using specially designed PCB provided by competing products. Novosense can provide a 16-pin general-purpose Demo board for comparison of temperature rises of competing products.

7. Package Information

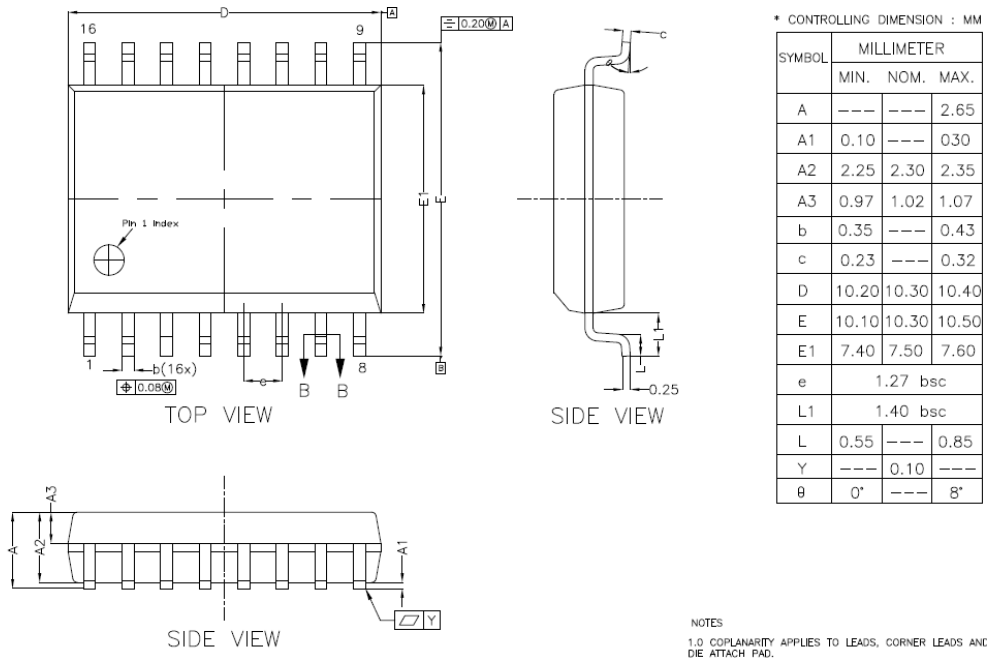

Figure 7.1 SOW16 Package Shape and Dimension in millimeters and (inches)

8. Order Information

Order information:

Part number	Primary current(A)	Power supply(V)	Sensitivity(mV/A)	Package
NSM2011-20B5R-DSWR	±20	5V	100	SOW16
NSM2011-30B5R-DSWR	±30	5V	66.67	SOW16
NSM2011-50B5R-DSWR	±50	5V	40	SOW16
NSM2011-65B3R-DSWR	±65	3.3V	20.31	SOW16
NSM2011-65B5R-DSWR	±65	5V	30.77	SOW16

Other ordering material numbers are acceptable: *If you need other current ranges, please contact Novosense for special support

Naming rules:

NSM2011-50B5R-DSWR

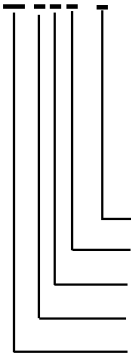

D: Industry, Q: Automotive

R: Ratiometric, F: fixed

5: 5V power supply, 3: 3.3V power supply

B: Bipolar, U: Unipolar

50: Current range

Have 10A/20A/30A/40/50A/65A current range, the standard order is 20A, 30A, 50A version

9. TAPE AND REEL INFORMATION

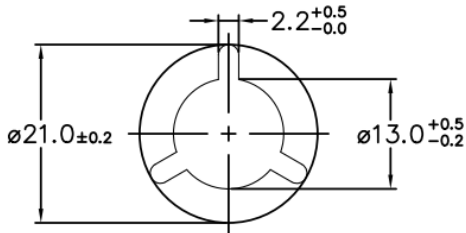
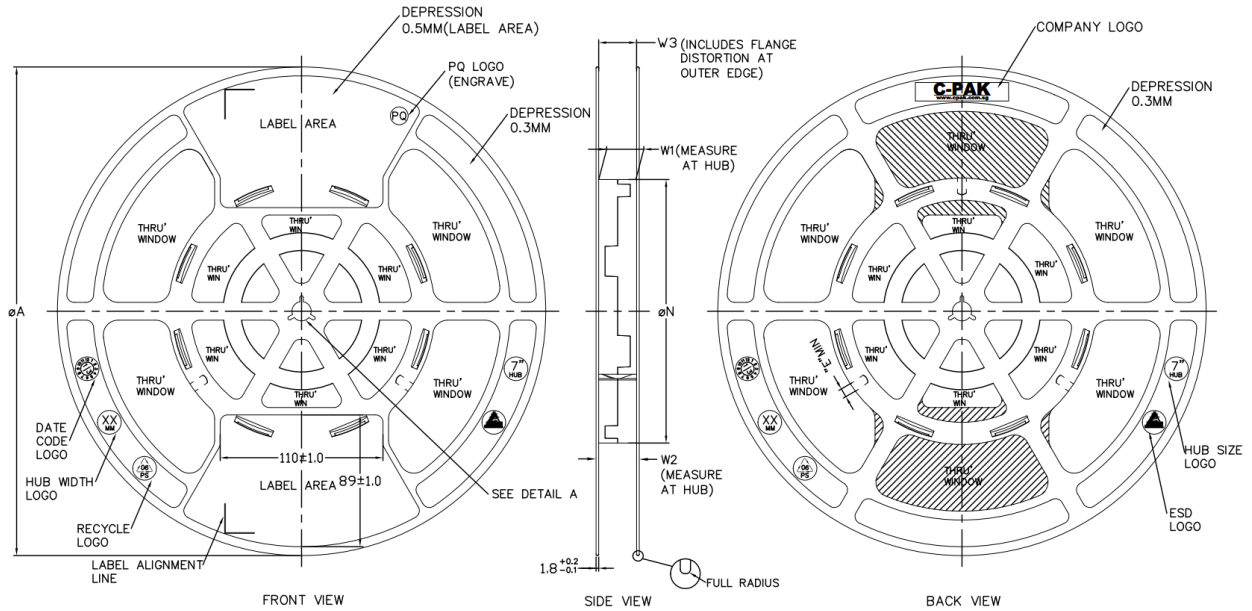

ARBOR HOLE
DETAIL A
SCALE : 3:1

PRODUCT SPECIFICATION						
TAPE WIDTH	ϕA ± 2.0	ϕN ± 2.0	W1	W2 (MAX)	W3	E (MIN)
08MM	330	178	$8.4^{+1.5}_{-0.0}$	14.4	SHALL ACCOMMODATE TAPE WIDTH WITHOUT INTERFERENCE	5.5
12MM	330	178	$12.4^{+2.0}_{-0.0}$	18.4		5.5
16MM	330	178	$16.4^{+2.0}_{-0.0}$	22.4		5.5
24MM	330	178	$24.4^{+2.0}_{-0.0}$	30.4		5.5
32MM	330	178	$32.4^{+2.0}_{-0.0}$	38.4		5.5

SURFACE RESISTIVITY			
LEGEND	SR RANGE	TYPE	COLOUR
A	BELOW 10^{12}	ANTISTATIC	ALL TYPES
B	10^9 TO 10^{11}	STATIC DISSIPATIVE	BLACK ONLY
C	10^5 & BELOW 10^8	CONDUCTIVE (GENERIC)	BLACK ONLY
E	10^9 TO 10^{11}	ANTISTATIC (COATED)	ALL TYPES

Note: MPQ(SOW16):1K

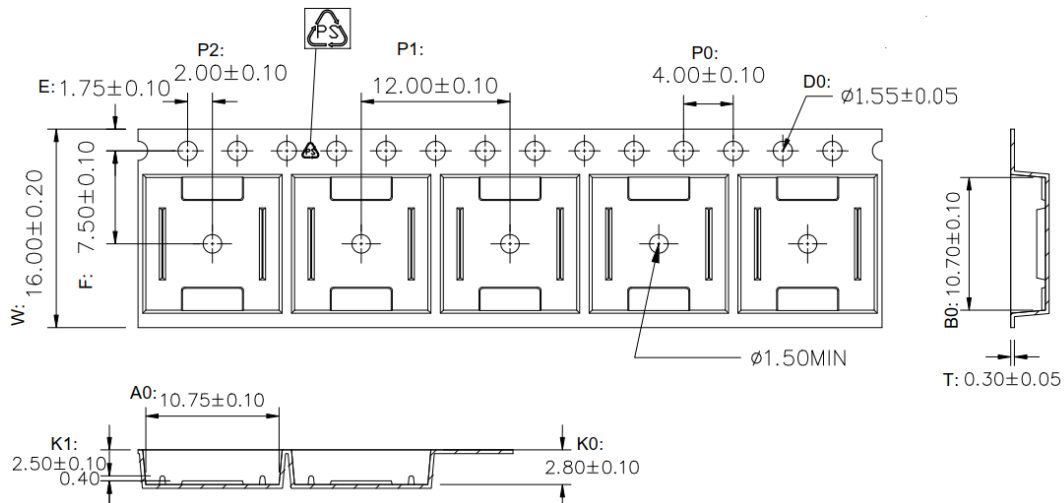

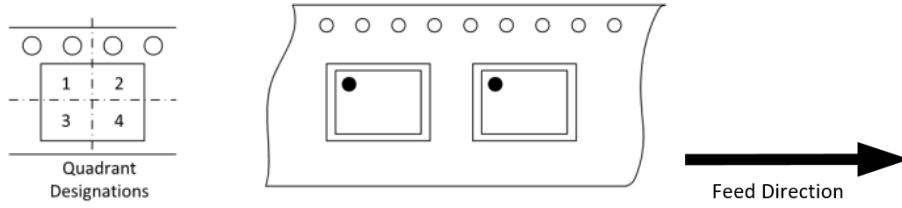

Figure 9.1 Tape and Reel Information of SOW16

10. Revision History

Revision	Description	Date
1.0	Release 1.0 Version.	2022/2/8