

SCHOTTKY BARRIER DIODE
FEATURES

- High frequency operation
- Guard ring for enhanced ruggedness and long term reliability
- Low forward voltage drop
- Designed and qualified for industrial level
- Surface Mount device

SMA
MECHANICAL DATA

- Case: SMA(DO-214AC)
- Case Material: Molded Plastic. UL flammability
- Classification Rating: 94V-0
- Weight: 0.065 grams (approximate)
- Marking:15MQ040

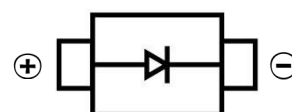

MAJOR RATINGS AND CHARACTERISTICS			
SYMBOL	CHARACTERISTICS	VALUES	UNITS
$I_{F(AV)}$	DC	1.5	A
V_{RRM}		40	V
I_{FSM}	$t_p = 5 \mu s$ sine	330	A
V_F	$2 A_{pk}, T_J = 125^\circ C$	0.43	V
T_J	Range	- 40 to 150	$^\circ C$

VOLTAGE RATINGS			
PARAMETER	SYMBOL	15MQ040	UNITS
Maximum DC reverse voltage	V_R	40	V
Maximum working peak reverse voltage	V_{RWM}		

ABSOLUTE MAXIMUM RATINGS					
PARAMETER	SYMBOL	TEST CONDITIONS		VALUES	UNITS
Maximum average forward current See fig. 4	$I_{F(AV)}$	50 % duty cycle at $T_L = 105^\circ C$, rectangular waveform On PC board 9 mm ² island (0.013 mm thick copper pad area)		2.1	A
		50 % duty cycle at $T_L = 113^\circ C$, rectangular waveform On PC board 9 mm ² island (0.013 mm thick copper pad area)		1.5	
Maximum peak one cycle non-repetitive surge current See fig. 6	I_{FSM}	5 μs sine or 3 μs rect. pulse	Following any rated load condition and with rated V_{RRM} applied	330	A
		10 ms sine or 6 ms rect. pulse		140	
Non-repetitive avalanche energy	E_{AS}	$T_J = 25^\circ C, I_{AS} = 1 A, L = 12 mH$		6.0	mJ
Repetitive avalanche current	I_{AR}	Current decaying linearly to zero in 1 μs Frequency limited by T_J maximum $V_A = 1.5 \times V_R$ typical		1.0	A

SCHOTTKY BARRIER DIODE

ELECTRICAL SPECIFICATIONS					
PARAMETER	SYMBOL	TEST CONDITIONS		VALUES	UNITS
Maximum forward voltage drop See fig. 1	$V_{FM}^{(1)}$	1.5 A	$T_J = 25\text{ }^\circ\text{C}$	0.43	V
		2 A		0.49	
		1.5 A	$T_J = 125\text{ }^\circ\text{C}$	0.34	
		2 A		0.43	
Maximum reverse leakage current See fig. 2	I_{RM}	$T_J = 25\text{ }^\circ\text{C}$	$V_R = \text{Rated } V_R$	0.5	mA
		$T_J = 125\text{ }^\circ\text{C}$		20	
Threshold voltage	$V_{F(TO)}$	$T_J = T_J \text{ maximum}$		0.26	V
Forward slope resistance	r_t			64.6	m Ω
Typical junction capacitance	C_T	$V_R = 10\text{ V}_{DC}$, $T_J = 25\text{ }^\circ\text{C}$, test signal = 1 MHz		134	pF
Typical series inductance	L_S	Measured lead to lead 5 mm from package body		2.0	nH
Maximum voltage rate of change	dV/dt	Rated V_R		10 000	V/ μ s

Note

(1) Pulse width = 300 μ s, duty cycle = 2 %

THERMAL - MECHANICAL SPECIFICATIONS					
PARAMETER	SYMBOL	TEST CONDITIONS		VALUES	UNITS
Maximum junction and storage temperature range	$T_J^{(1)}$, T_{Stg}			- 40 to 150	$^\circ\text{C}$
Maximum thermal resistance, junction to ambient	R_{thJA}	DC operation		80	$^\circ\text{C/W}$
Approximate weight				0.07	g
				0.002	oz.
Marking device		Case style SMA (similar D-64)		XF	

Note

(1) $\frac{dP_{tot}}{dT_J} < \frac{1}{R_{thJA}}$ thermal runaway condition for a diode on its own heatsink

SCHOTTKY BARRIER DIODE

Typical Characteristics

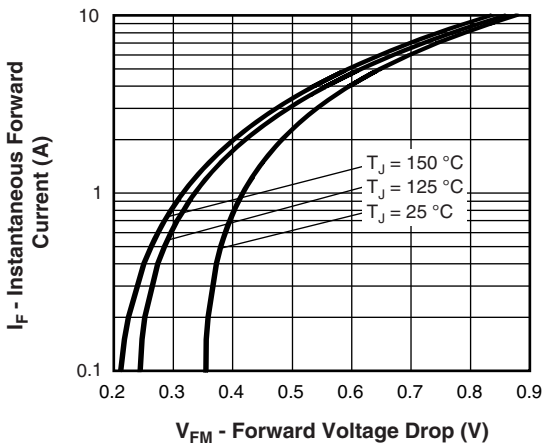

Fig. 1 - Maximum Forward Voltage Drop Characteristics

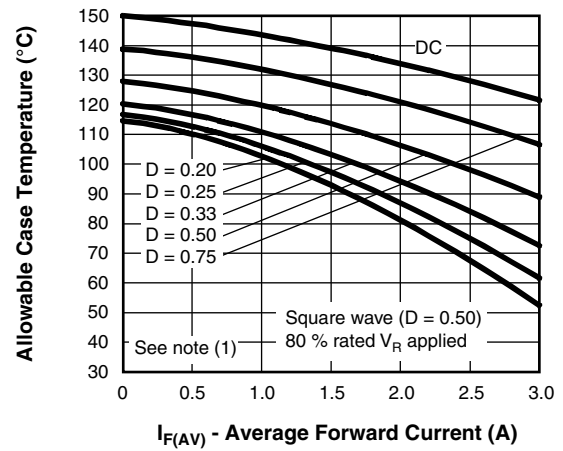

Fig. 4 - Maximum Average Forward Current vs. Allowable Lead Temperature

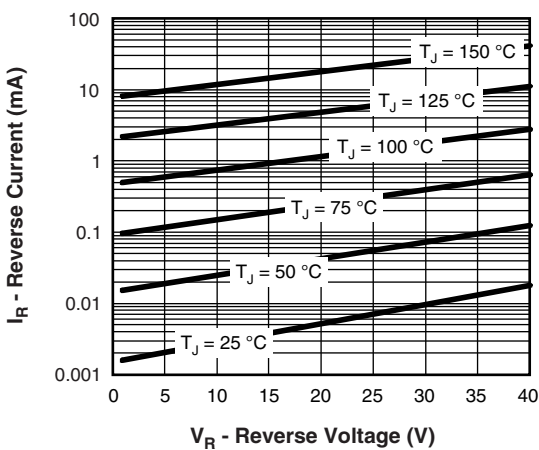

Fig. 2 - Typical Peak Reverse Current vs. Reverse Voltage

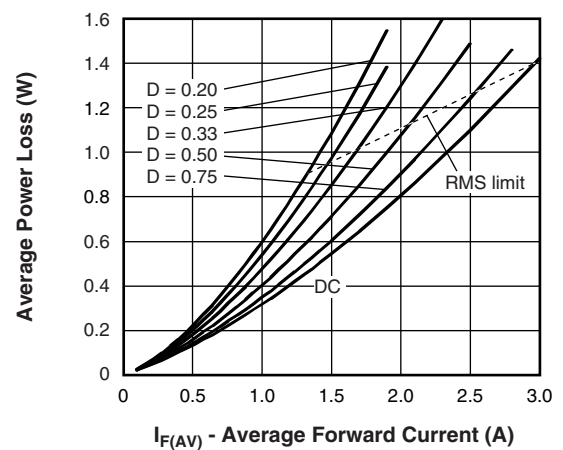

Fig. 5 - Maximum Average Forward Dissipation vs. Average Forward Current

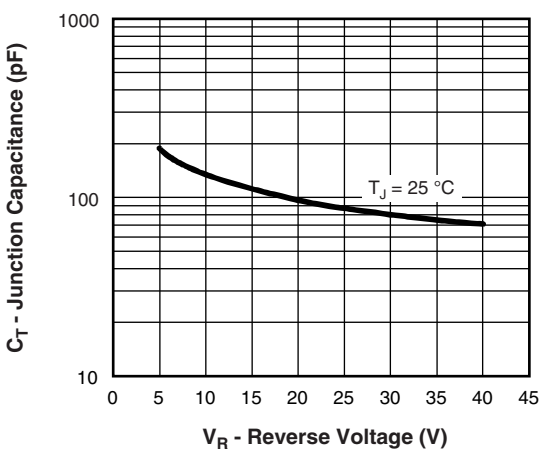

Fig. 3 - Typical Junction Capacitance vs. Reverse Voltage

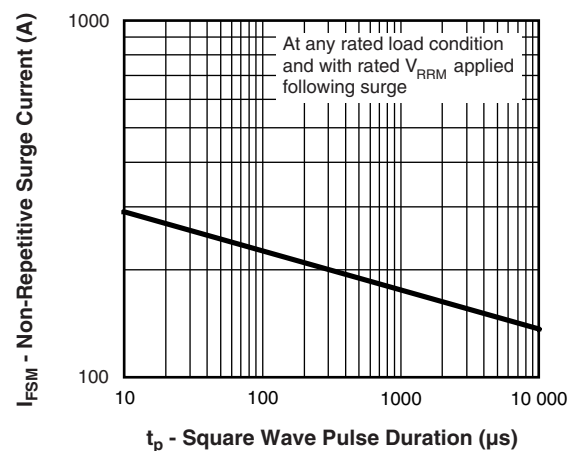

Fig. 6 - Maximum Peak Surge Forward Current vs. Pulse Duration

Note

- (1) Formula used: $T_C = T_J - (P_d + P_{d_{REV}}) \times R_{thJC}$;
 P_d = Forward power loss = $I_{F(AV)} \times V_{FM}$ at $(I_{F(AV)}/D)$ (see fig. 6); $P_{d_{REV}}$ = Inverse power loss = $V_{R1} \times I_R (1 - D)$; I_R at $V_{R1} = 80\%$ rated V_R

SCHOTTKY BARRIER DIODE

SMA Package Outline Dimensions

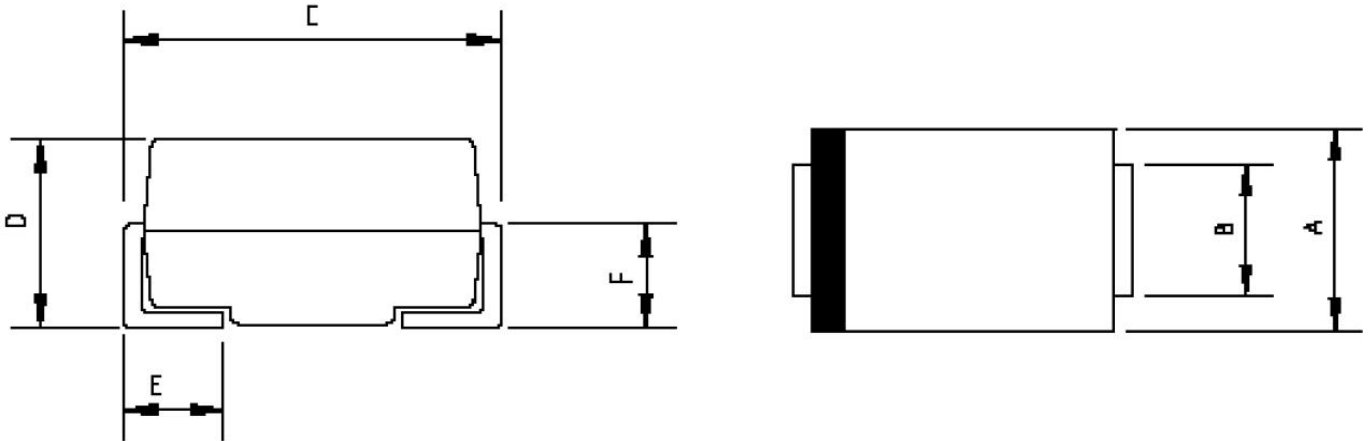

Symbol	Dimensions In Millimeters		Dimensions In Inches	
	Min.	Max.	Min.	Max.
A	2.20	2.80	0.086	0.110
B	1.30	1.70	0.051	0.067
C	4.70	5.30	0.185	0.209
D	1.70	2.55	0.067	0.100
E	0.90	1.50	0.035	0.059
F	0.90	1.50	0.035	0.059

SMA Suggested Pad Layout

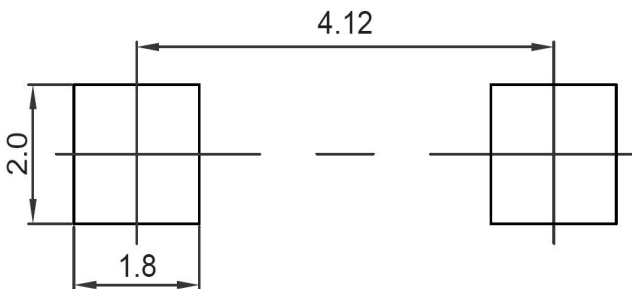

Note:

1. Controlling dimension: in millimeters
2. General tolerance: $\pm 0.05\text{mm}$
3. The pad layout is for reference purposes only

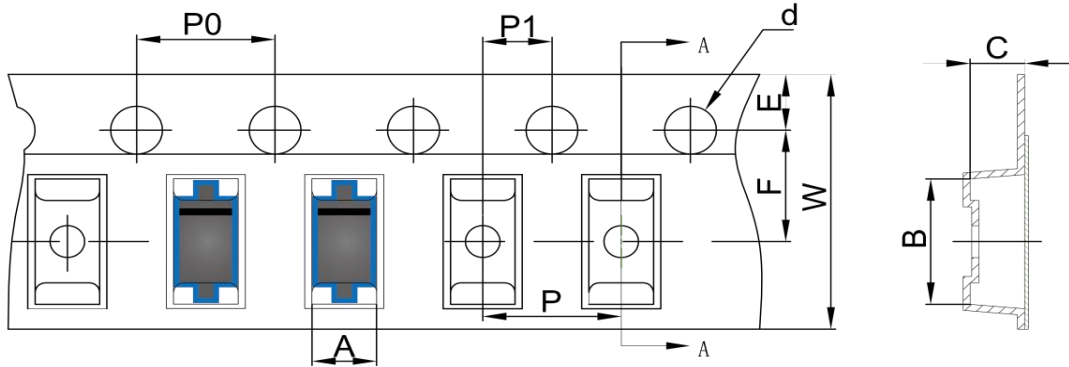
SCHOTTKY BARRIER DIODE
SMA Tape and Reel
SMA Embossed Carrier Tape

DIMENSIONS ARE IN MILLIMETER										
TYPE	A	B	C	d	E	F	P0	P	P1	W
SMA	2.89	5.35	2.68	Ø1.50	1.75	5.50	4.00	4.00	2.00	12.00
TOLERANCE	±0.1	±0.1	±0.1	±0.1	±0.1	±0.1	±0.1	±0.1	±0.1	±0.1

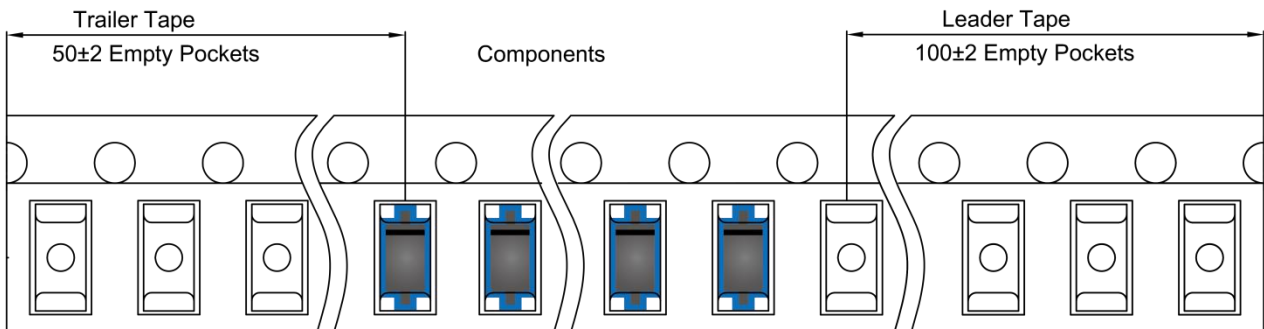
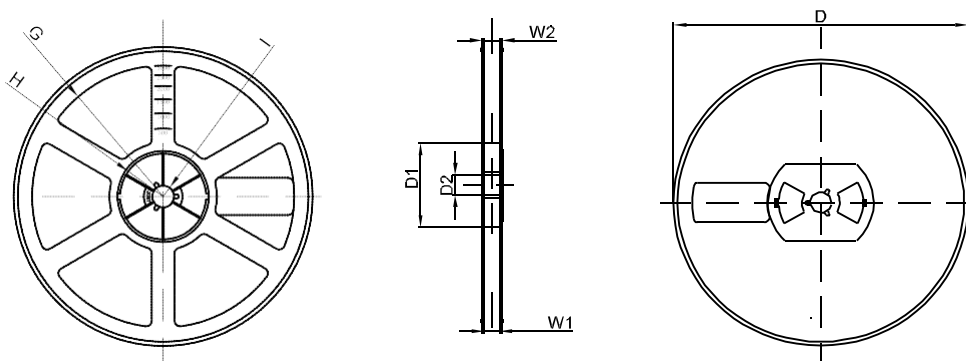
SMA Tape Leader and Trailer

SMA Reel

DIMENSIONS ARE IN MILLIMETER								
REEL OPTION	D	D1	D2	G	H	I	W1	W2
7" DIA	Ø178	54.40	13.00	R78	R25.60	R6.50	12.40	17.60
TOLERANCE	±2	±1	±1	±1	±1	±1	±1	±1