

Compact LCD Bias Supply for TFT-LCD TV Panels

Check for Samples: [TPS65171](#)

FEATURES

- 8.5V to 14.7V Input Voltage Range
- V_S Output Voltage Range up to 19V
- Boost Converter with 2.5A Switch Current
- Step Down Converter with 1A Switch Current and Adjustable Output 2.5V to 3.3V
- 750kHz Fixed Switching Frequency
- Temperature Compensated Negative Supply LCD technology using ASG gate drive circuits
- High Voltage Stress Test (HVS)
- Adjustable Sequencing
- Gate Drive Signal for Isolation Switch
- Short Circuit Protection
- Internal Soft-Start
- 180° Phase Shift Between Buck and Boost
- P2P Short/Open Certified
- Optimized Dual Layer PCB Layout
- Low EMI
- Undervoltage Lockout
- Thermal Shutdown
- Available in 6x6mm 40 Pin QFN Package

TYPICAL APPLICATION

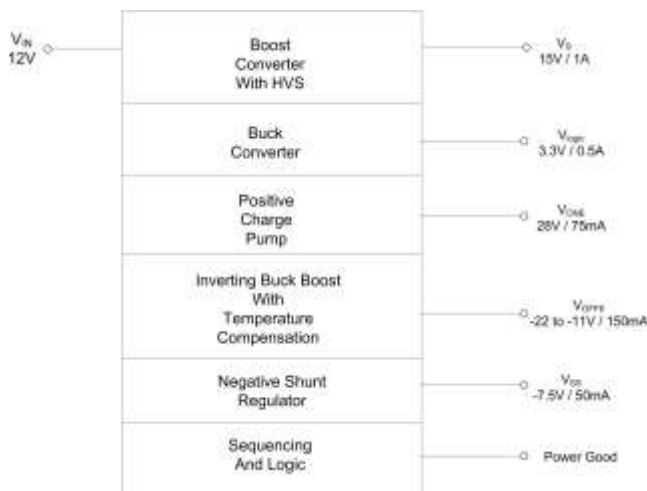

APPLICATIONS

- LCD TV Panel with ASG Technology

DESCRIPTION

The TPS65171 offers a compact power supply solution to provide all voltages required by a LCD panel for large TV panel applications running from a 12V supply rail. The device is optimized to support LCD technology using ASG gate drive circuits.

The device generates all voltage rails for the TFT LCD bias (V_S , V_{ONE} , V_{OFFE} , V_{SS}). In addition to that it includes a step-down converter (V_{logic}) to provide the logic voltage. By pulling the HVS pin high an implemented high voltage stress test feature programs the boost converter output voltage V_S to higher values. The boost converter operates at a fixed switching frequency of 750kHz. The positive charge pump is running from the boost converter and is regulated by an external transistor. A buck-boost converter provides an adjustable temperature dependent negative output voltage V_{OFFE} . The negative output voltage V_{SS} is regulated by a shunt regulator.

Safety features like overvoltage protection of the buck-boost input voltage, the boost and buck output voltage, undervoltage lockout, short circuit protection of V_{ONE} , V_{OFFE} , and V_{logic} are included as well as thermal shutdown.



Please be aware that an important notice concerning availability, standard warranty, and use in critical applications of Texas Instruments semiconductor products and disclaimers thereto appears at the end of this data sheet.

PowerPAD is a trademark of Texas Instruments.



This integrated circuit can be damaged by ESD. Texas Instruments recommends that all integrated circuits be handled with appropriate precautions. Failure to observe proper handling and installation procedures can cause damage.

ESD damage can range from subtle performance degradation to complete device failure. Precision integrated circuits may be more susceptible to damage because very small parametric changes could cause the device not to meet its published specifications.

ORDERING INFORMATION^{(1) (2)}

T _A	ORDERING	PACKAGE	PACKAGE MARKING
–40°C to 85°C	TPS65171RHAR	6 x 6mm 40 Pin QFN	TPS65171

- (1) For the most current package and ordering information, see the Package Option Addendum at the end of this document, or see the TI website at www.ti.com.
- (2) The RHA package is available taped and reeled. Add R suffix to the device type (TPS65171RHAR) to order the device taped and reeled. The RHA package has quantities of 3000 devices per reel.

ABSOLUTE MAXIMUM RATINGS

over operating free-air temperature range (unless otherwise noted)⁽¹⁾

	VALUE	UNIT
Input voltage range AVIN, VIN1, VIN2, VIN3 ⁽²⁾	–0.3 to 20	V
Voltage range at SW1, SW2, SW3, SW4, GD, BASE2, RHVS, OS	–0.3 to 20	V
Voltage range at EN1, EN2, HVS	–0.3 to 20	V
Voltage range at COMP, SS, FB1, VSNS, FB2, FB3, FB4, TS, SET, FB5, DLY1, DLY2, PG	–0.3 to 7.0	V
Voltage difference VIN3 to SW5	40	V
BASE1	–9.5 to 0.3	V
ESD rating, Human Body Model	2	kV
ESD rating, Machine Model	200	V
ESD rating, Charged Device Model	700	V
Continuous total power dissipation	See Dissipation Rating Table	
Operating junction temperature range, T _J	–40 to 150	°C
Operating ambient temperature range, T _A	–40 to 85	°C
Storage temperature range, T _{stg}	–65 to 150	°C

- (1) Stresses beyond those listed under *absolute maximum ratings* may cause permanent damage to the device. These are stress ratings only and functional operation of the device at these or any other conditions beyond those indicated under *recommended operating conditions* is not implied. Exposure to absolute–maximum–rated conditions for extended periods may affect device reliability.
- (2) All voltage values are with respect to network ground terminal.

DISSIPATION RATINGS⁽¹⁾

PACKAGE	R _{θJA}	T _A = 25°C POWER RATING	T _A = 70°C POWER RATING	T _A = 85°C POWER RATING
40 pin QFN	35°C/W	2.8W	1.6W	1.1W

- (1) Soldered Power Pad on a standard 2-Layer PCB without vias for thermal pad. See the Texas Instruments Application report ([SLMA002](#)) regarding thermal characteristics of the PowerPAD package.

RECOMMENDED OPERATING CONDITIONS⁽¹⁾

	MIN	TYP	MAX	UNIT
V _{IN} Input voltage range (AVIN, VIN1, VIN2, VIN3)	8.5		14.7	V
V _{IN3} Overvoltage protection 15V for buck-boost converter	15			V
T _A Operating ambient temperature	–40		85	°C
T _J Operating junction temperature	–40		125	°C

- (1) Refer to application section for further information

ELECTRICAL CHARACTERISTICS

AVIN=VIN1=VIN2=VIN3=12V, EN1=EN2=VIN, VS=15V, Vlogic=3.3V, TA = -40°C to 85°C, typical values are at TA = 25°C (unless otherwise noted)

PARAMETER		TEST CONDITIONS	MIN	TYP	MAX	UNIT
SUPPLY CURRENT						
VIN	Input voltage range		8.5		14.7	V
IQIN	Quiescent current into AVIN, VIN1,2,3	Not switching, FB=FB+5%		1.2		mA
I _{sd}	Shutdown current into AVIN, VIN1,2,3	EN1=EN2=GND		170		μA
VUVLO	Under-voltage lockout threshold	VIN falling		8.0	8.2	V
VUVLO	Under-voltage lockout threshold	VIN rising		8.2	8.5	V
	Thermal shutdown	Temperature rising		150		°C
	Thermal shutdown hysteresis			15		°C
LOGIC SIGNALS EN1, EN2, HVS						
V _{IH}	High level input voltage	VIN = 8.5V to 14.7V	1.7			V
V _{IL}	Low level input voltage	VIN = 8.5V to 14.7V			0.4	V
I _i	Input leakage current	EN1=EN2=GND		0.01	0.1	μA
POWER GOOD						
V _{IL}	Low level voltage ⁽¹⁾	I _(sink) = 500 μA			0.3	V
I _{lkg}	Leakage current	V _{PG} = 5.0V		0.01	0.1	μA
SEQUENCING DLY1, DLY2, and SOFT-START						
I _{chrg}	DLY1, DLY2 charge current	V _{threshold} = 1.24V	4	4.9	6.3	μA
V _{threshold}	DLY1, DLY2 threshold voltage		1.21	1.24	1.27	V
R _{dischrg}	DLY1, DLY2 discharge resistor			3.2		kΩ
I _{SS}	Soft-start charge current	V _{threshold} = 1.24V	8	10	12	μA
SWITCHING FREQUENCY						
f _s	Switching frequency		600	750	900	kHz
BOOST CONVERTER (V_s)						
V _s	Output voltage range				19	V
V _{swovp}	Switch overvoltage protection	V _s rising	19.0	19.5	20	V
V _{FB1}	Feedback regulation voltage		1.225	1.24	1.252	V
I _{FB1}	Feedback input bias current	V _{FB1} = 1.24V		10	100	nA
R _{DS(on)}	N-MOSFET on-resistance	I _{sw} = 500mA		120	170	mΩ
I _{LIM}	N-MOSFET switch current limit		2.5	3.2	4.0	A
I _{leak}	Switch leakage current	V _{sw} = 15V		1	10	μA
t _{on}	Minimum on time			80		ns
	Line regulation	8.5V ≤ V _{IN} ≤ 14.7V, I _{out} = 1mA		0.006		%/V
	Load regulation	1mA ≤ I _{out} ≤ 1A		0.1		%/A
GATE DRIVE (GD) AND BOOST CONVERTER PROTECTION						
V _{GD_M}	V _{IN} - V _{GD} ⁽²⁾	V _{IN} = 12V, GD pulled down	5	6	7	V
I _(GD)	Gate drive sink current	EN2 = high		10		μA
R _(GD)	Gate drive internal pull up resistance			10		kΩ
t _{on}	Gate on time during short circuit	FB1 < 100mV		1.4		ms
BUCK CONVERTER (V_{logic})						
V _{logic}	Output voltage range		2.2		4.0	V
V _{FB2}	Feedback regulation voltage	FB2 connected to resistor divider, I _{load} = 10mA	1.215	1.24	1.265	V
I _{FB2}	Feedback input bias current	V _{FB2} = 1.24V		10	100	nA
R _{DS(on)}	N-MOSFET on-resistance	I _{sw3} , I _{sw4} = 0.5A		150	250	mΩ

(1) PG goes high impedance once V_s and V_{ONE} are in regulation.

(2) GD goes to V_{IN} - V_{GD} once the boost converter V_s is enabled.

ELECTRICAL CHARACTERISTICS (continued)

AVIN=VIN1=VIN2=VIN3=12V, EN1=EN2=VIN, VS=15V, Vlogic=3.3V, TA = -40°C to 85°C, typical values are at TA = 25°C (unless otherwise noted)

PARAMETER		TEST CONDITIONS	MIN	TYP	MAX	UNIT
ILIM	N-MOSFET switch current limit		1			A
Ileak	Switch leakage current	Vsw = 0V		1		μA
	Line regulation	8.5V ∇ V IN ∇ 14.7V, Iout = 1mA		0.006		%/V
	Load regulation	1mA ∇ Iout ∇ 100mA		0.042		%/mA
		100mA ∇ Iout ∇ 1A		0.06		%/A
NEGATIVE SHUNT REGULATOR (VSS)						
VBase1	Base1 voltage range	Transistor leakage maximum 5 μA	-9.5		0.3	V
IBase1	Base1 drive source current	VFB3 = VFB3nominal - 5%	5			mA
VFB3	Feedback regulation voltage		-5%	0.75 × Vlogic	5%	V
IFB3	Feedback input bias current	VFB3 = 1.24V		10	100	nA
	Line regulation	8.5V ∇ V IN ∇ 14.7V, Iout = 1mA		0.006		%/V
	Load regulation	1mA ∇ Iout ∇ 50mA		0.0004		%/mA
NEGATIVE BUCK BOOST CONVERTER (VOFFE)						
Vovp	VIN3 overvoltage protection		15			V
VOFFE	Adjustable output voltage range		-22		-5	V
RDS(on)	P-MOSFET on resistance	ISW5 at current limit		0.9	1.6	Ω
ILIM	P-MOSFET current limit		0.8	1		A
VFB5	Regulation accuracy upper limit	VTS = 1V, VSET = 1.9V	1.8	1.9	2.0	V
	Regulation accuracy	VTS = 1V, VSET = 2.4V	1.9	2	2.1	V
	Regulation accuracy lower limit	VTS = 0.7V, VSET = 2.4V	1.57	1.65	1.73	V
IFB5	Feedback input bias current	VFB5 = 2V		10	100	nA
ITS	TS input bias current	VTS = 1V		10	100	nA
ISSET	SET input bias current	VSET = 3V		3	5	μA
	Line regulation	8.5V ∇ V IN ∇ 14.7V, Iout = 1mA		0.003		%/V
	Load regulation	1mA ∇ Iout ∇ 150mA, VOFFE = -11V		0.0005		%/mA
POSITIVE CHARGE PUMP (VONE)						
IBase2	Base2 drive sink current	VFB4 = VFB4nominal-5%	8	14		mA
	Base2 drive sink current (SC-Mode)	VFB4 = GND	40	50	70	A
VBase2	Base drive voltage range				20	V
VFB4	Feedback regulation voltage		1.18	1.24	1.30	V
IFB4	Feedback input bias current	VFB4 = 1.24V		10	100	nA
	Line regulation	8.5V ∇ V IN ∇ 14.7V, Iout = 1mA		0.9		%/V
	Load regulation	1mA ∇ Iout ∇ 75mA		0.004		%/mA
HIGH VOLTAGE STRESS TEST (HVS), RHVS						
RHVS	RHVS pull down resistance	HVS = high, IHVS = 500 μA	350	450	550	Ω
IRHVS	RHVS leakage current	HVS = low, VRHVS = 5V			100	nA

DEVICE INFORMATION

PACKAGE

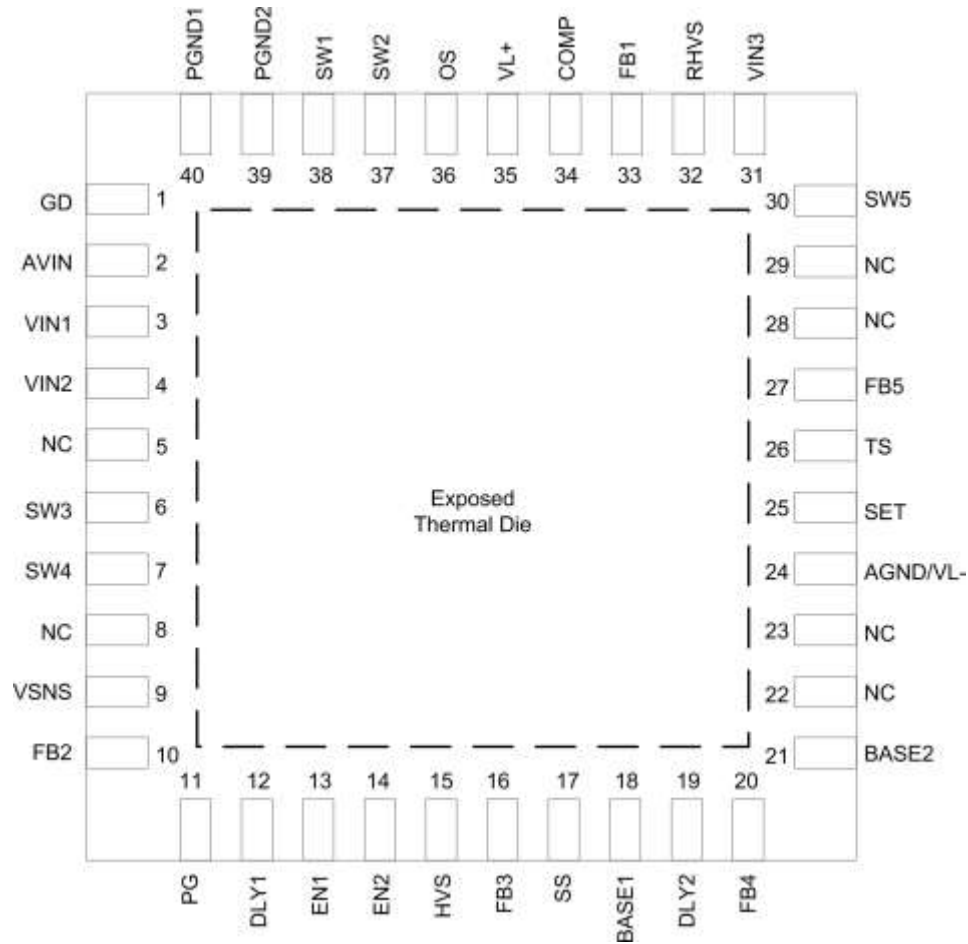

NOTE: The thermally enhance Power Pad is connected to GND

PIN FUNCTIONS

PIN		I/O	DESCRIPTION
NAME	NO.		
GD	1	I	Gate drive pin for the external isolation MOSFET.
AVIN	2	I	Input voltage supply pin for the analog circuit.
VIN1, VIN2	3,4	I	Input supply for the buck converter generating V_{logic}
NC	5		Not connected
SW3, SW4	6,7	O	Switch pin for the buck converter generating V_{logic}
NC	8		Not connected
VSNS	9	I	Reference voltage input for the buck-boost and negative shunt regulator
FB2	10	I	Feedback pin for the buck converter.
PG	11	I	Power good output latched high when V_S and V_{ONE} are in regulation
DLY1	12	O	Delay pin EN2 high to enable boost converter V_S
EN1	13	I	Enable of the buck converter V_{logic}
EN2	14	I	Enable of the negative supplies V_{SS} and V_{OFFE} , enable DLY1 and DLY2
HVS	15	I	Logic pin to enable high voltage stress test. This allows programming the boost converter V_S to a higher voltage
FB3	16	I	Feedback of the negative supply V_{SS}

PIN FUNCTIONS (continued)

PIN		I/O	DESCRIPTION
NAME	NO.		
SS	17	O	Soft-start for the boost converter V_S
BASE1	18	O	Base drive of the external npn transistor for the negative supply V_{SS}
DLY2	19	O	Delay pin EN2 high to enable charge pump V_{ONE}
FB4	20	I	Feedback for the positive supply V_{ONE}
BASE2	21	I	Base drive of the external pnp transistor for the positive charge pump V_{ONE}
NC	22, 23		Not connected
AGND/VL-	24		Analog ground and connection of the bypass capacitor of VL-
SET	25	I	Input pin for the reference voltage to set the higher limit for the temperature compensation for V_{OFFE}
TS	26	I	Input pin for the NTC temperature sensor
FB5	27	I	Feedback pin for the negative buck-boost converter V_{OFFE}
NC	28, 29		Not connected
SW5	30	O	Switch pin for the negative buck-boost converter generating V_{OFFE}
VIN3	31	I	Input supply for the buck-boost converter generating V_{OFFE}
RHVS	32	I	This pin is pulled low when HVS is high. The resistor connected to this pin sets the boost converter output voltage when HVS is pulled high
FB1	33	I	Feedback for the boost converter V_S
COMP	34	O	Compensation pin for the boost converter
VL+	35	O	Output of the internal logic regulator. Connect a capacitor between this pin and AGND/VL-
OS	36	I	Connect this pin to the boost converter output for overvoltage protection
SW1, SW2	37, 38	I	Switch pin for the boost converter and the positive charge pump V_{ONE}
PGND1, PGND2	39, 40		Power ground for the boost converter V_S

FUNCTIONAL BLOCK DIAGRAM

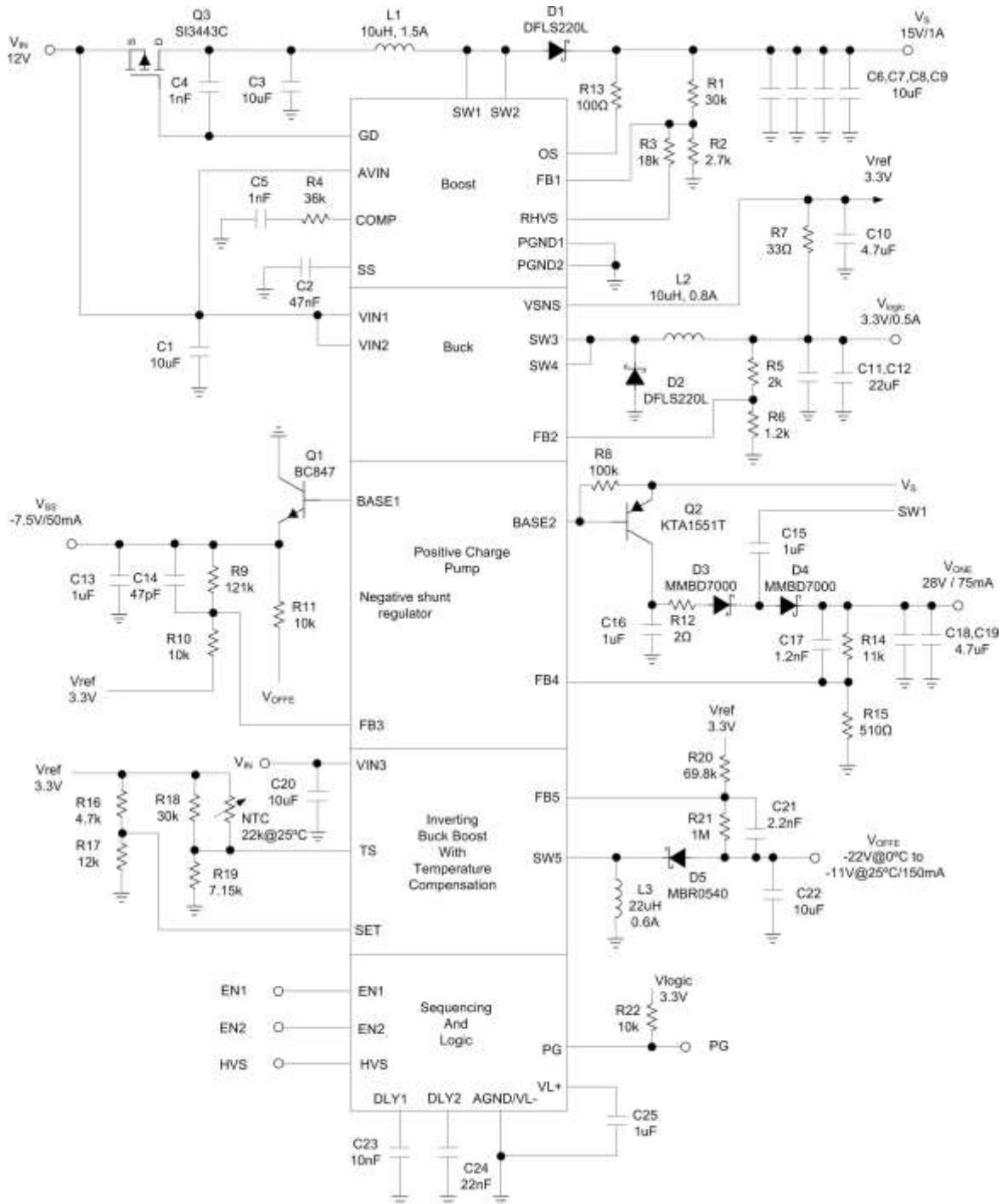

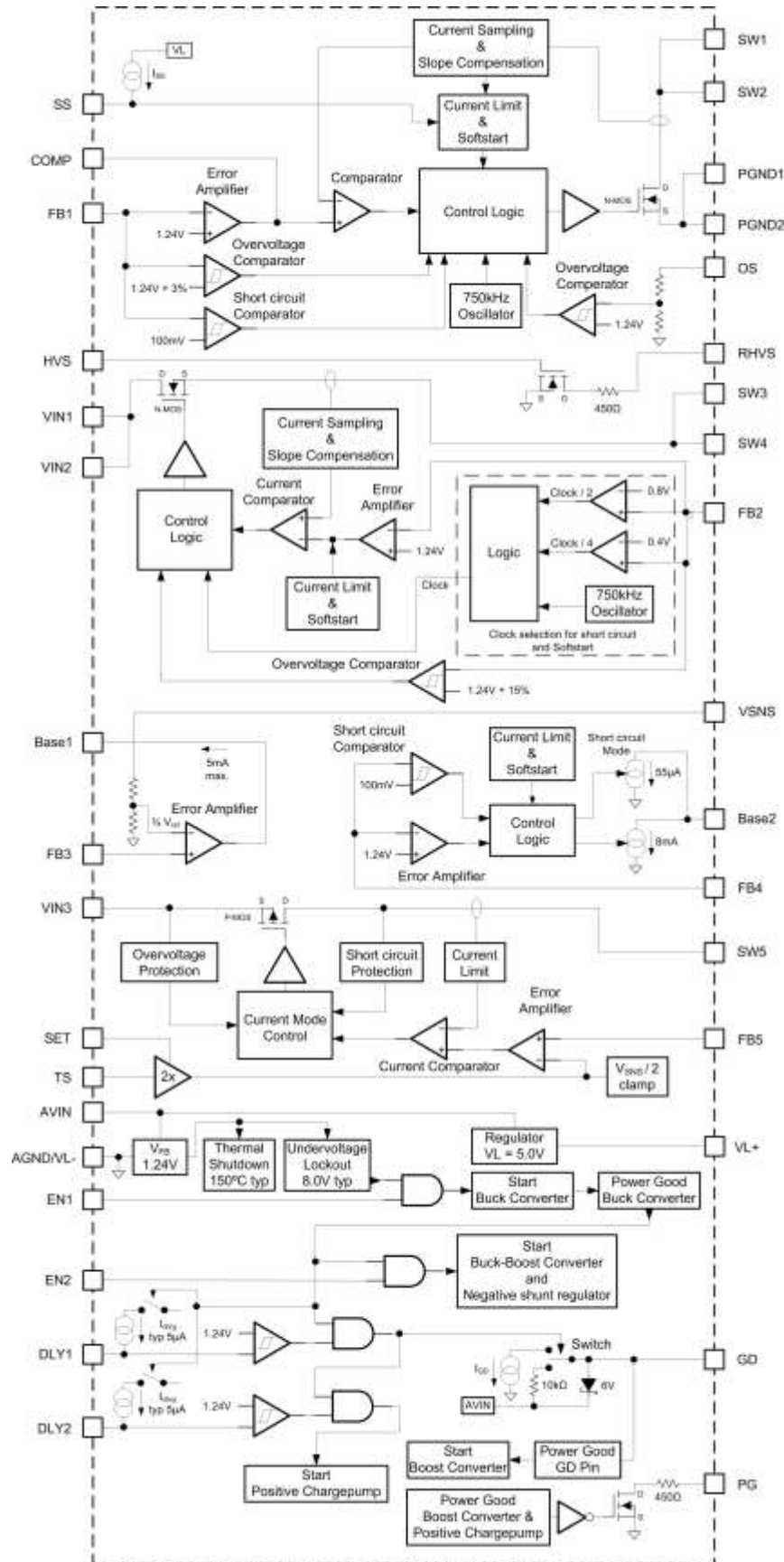

TYPICAL CHARACTERISTICS

TABLE OF GRAPHS

			FIGURE
Start-up Sequence			
	Startup sequencing		Figure 1
	Startup sequencing		Figure 2
Boost Converter			
	Soft-start boost converter	vs load current	Figure 3
	Efficiency boost converter	vs load current	Figure 4
	PWM operation	at nominal load current	Figure 5
	PWM operation	at light load current	Figure 6
	Load transient response boost converter		Figure 7
	Oversvoltage protection		Figure 8
Buck Converter			
	Efficiency buck converter	vs load current	Figure 9
	Soft-start buck converter	vs load current	Figure 10
	PWM operation	at nominal load current	Figure 11
	PWM operation	at light load current	Figure 12
	Load transient response buck converter		Figure 13
	180° Phase shift between boost and buck converter		Figure 14
Buck Boost Converter			
	Efficiency buck boost converter	vs load current	Figure 15
	PWM operation	at nominal load current	Figure 16
	PWM operation	at light load current	Figure 18
	Load transient response buck boost converter		Figure 17
Charge Pump			
	Load transient response positive charge pump	$V_s = 15V$	Figure 19
	Load transient response positive charge pump	$V_s = 18V$	Figure 20
Shunt Regulator			
	Load transient response negative shunt regulator		Figure 21

STARTUP SEQUENCING

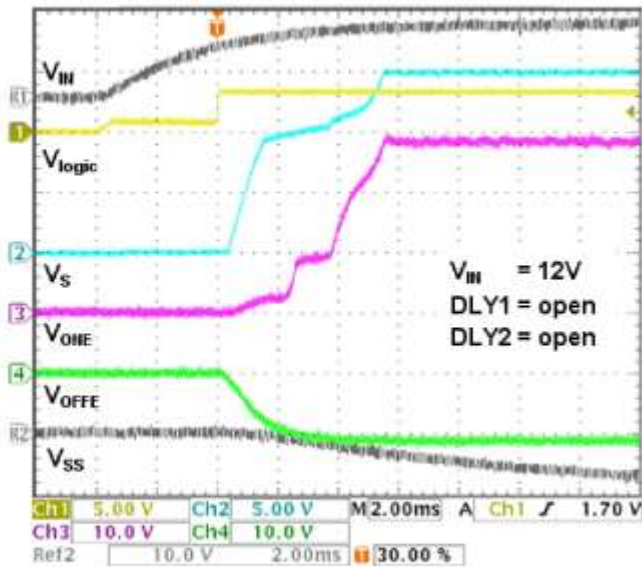

Figure 1.

STARTUP SEQUENCING

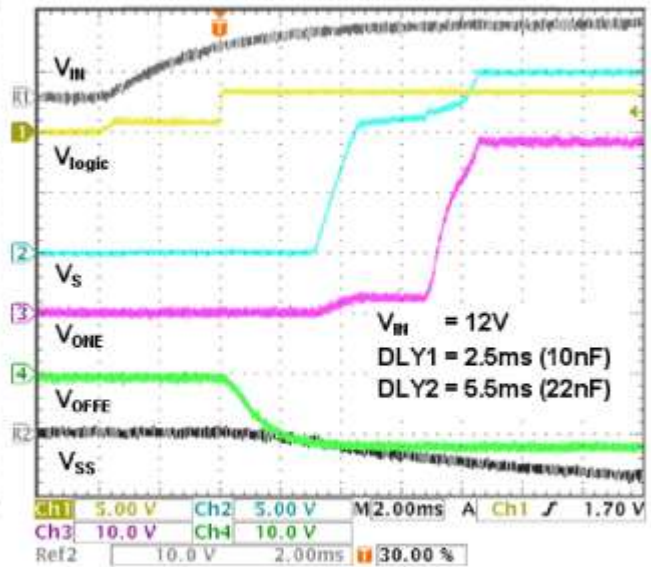

Figure 2.

SOFTSTART BOOST CONVERTER
VS
LOAD CURRENT

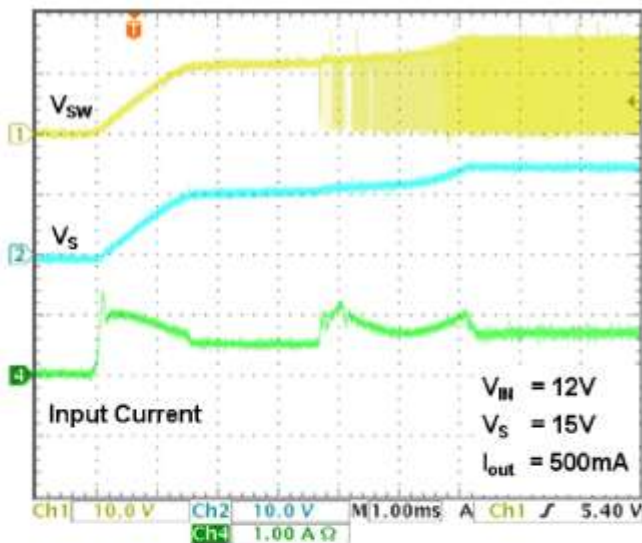

Figure 3.

EFFICIENCY BOOST CONVERTER
VS
LOAD CURRENT

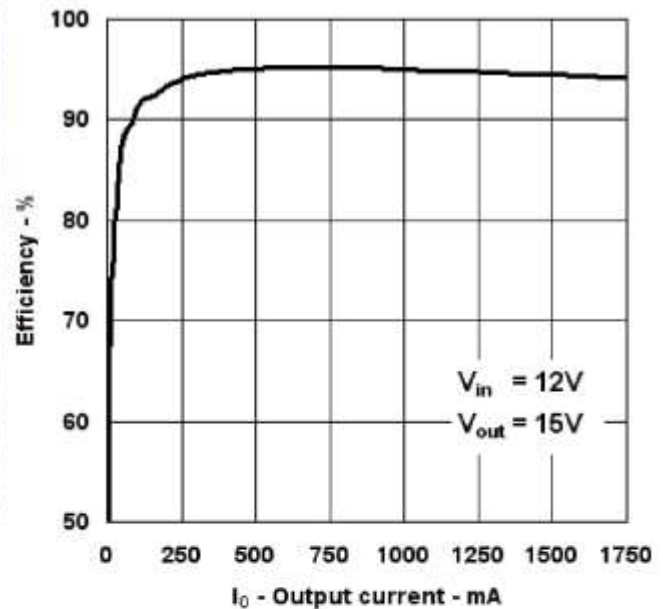

Figure 4.

PWM OPERATION AT NOMINAL LOAD CURRENT

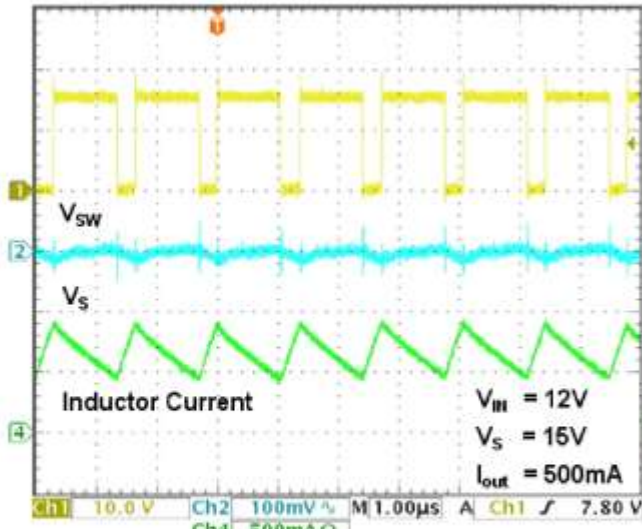

Figure 5.

PWM OPERATION AT LIGHT LOAD CURRENT

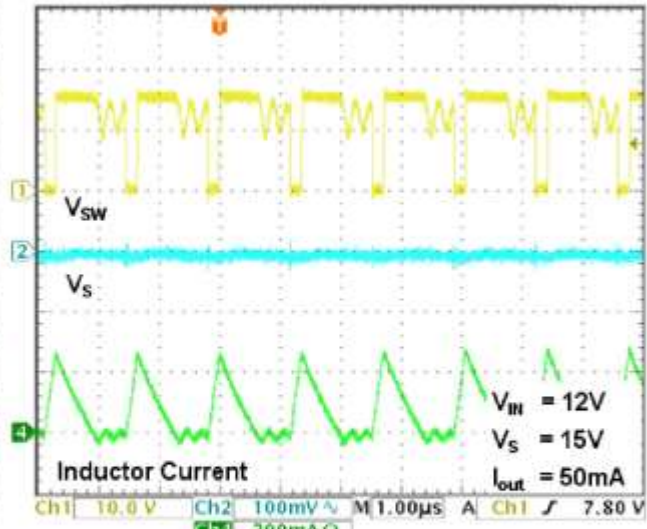

Figure 6.

LOAD TRANSIENT RESPONSE BOOST CONVERTER

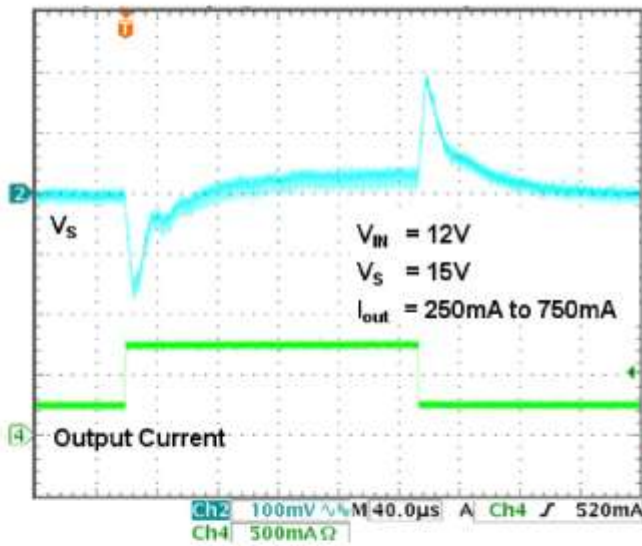

Figure 7.

OVER VOLTAGE PROTECTION

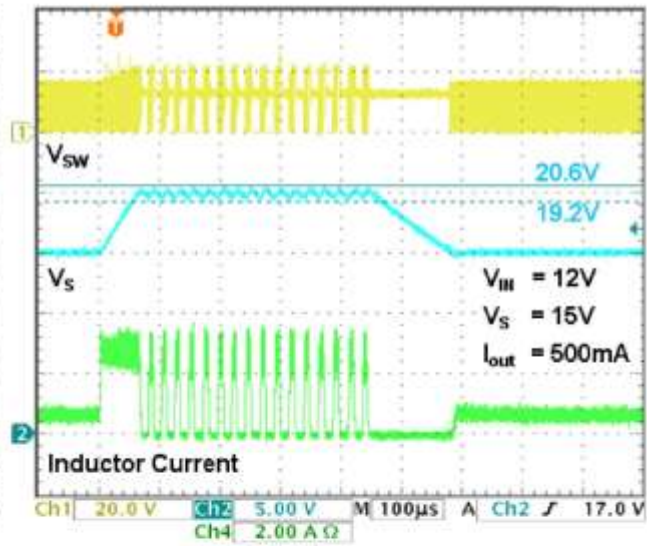

Figure 8.

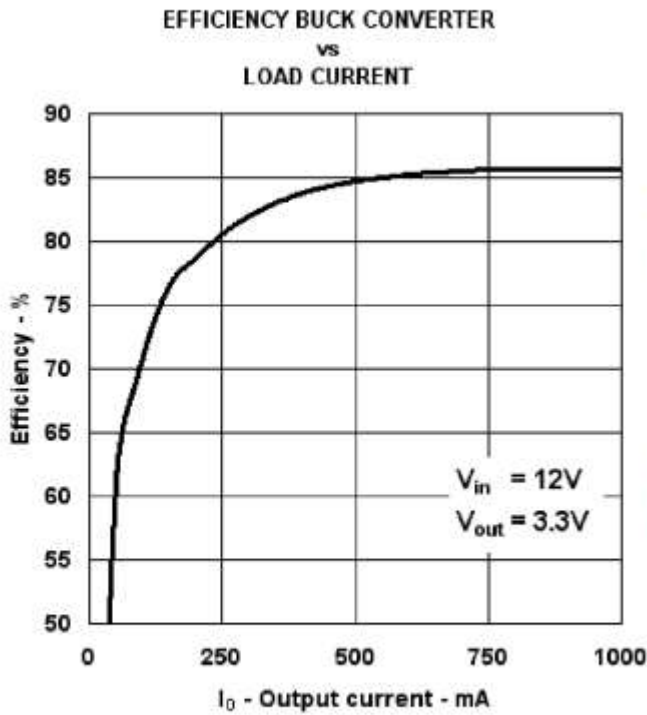

Figure 9.

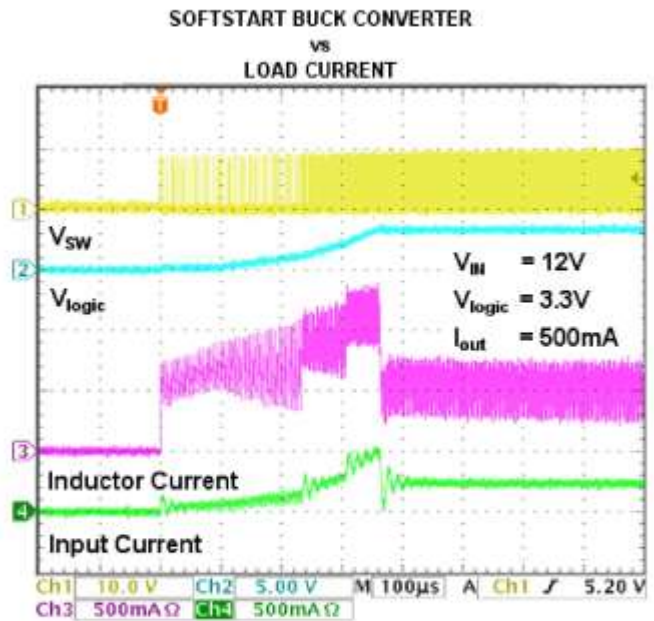

Figure 10.

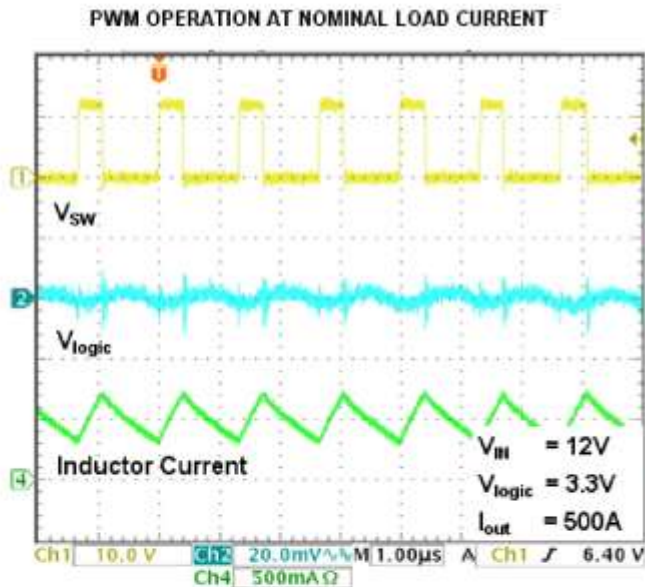

Figure 11.

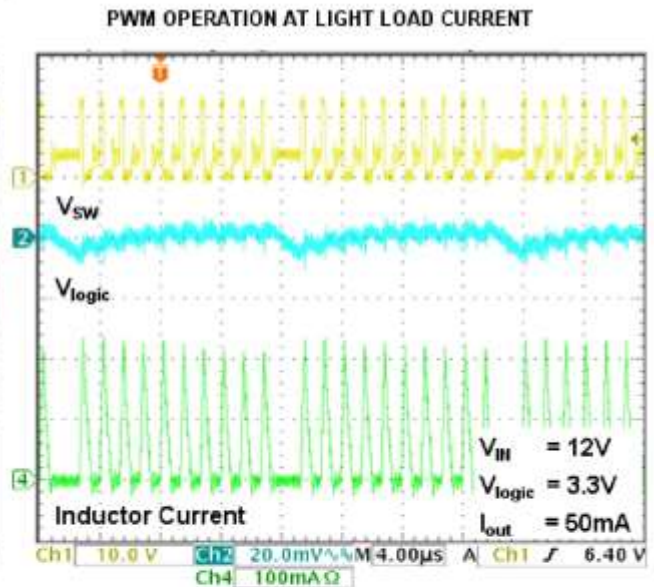

Figure 12.

LOAD TRANSIENT RESPONSE BUCK CONVERTER

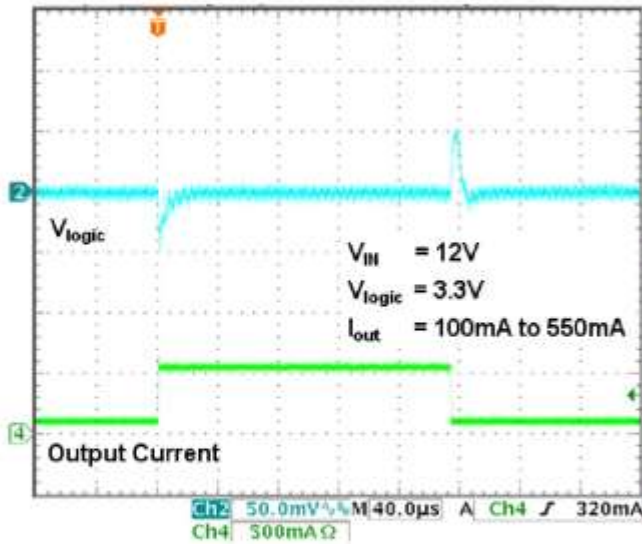

Figure 13.

180° PHASE SHIFT BETWEEN BOOST AND BUCK CONVERTER

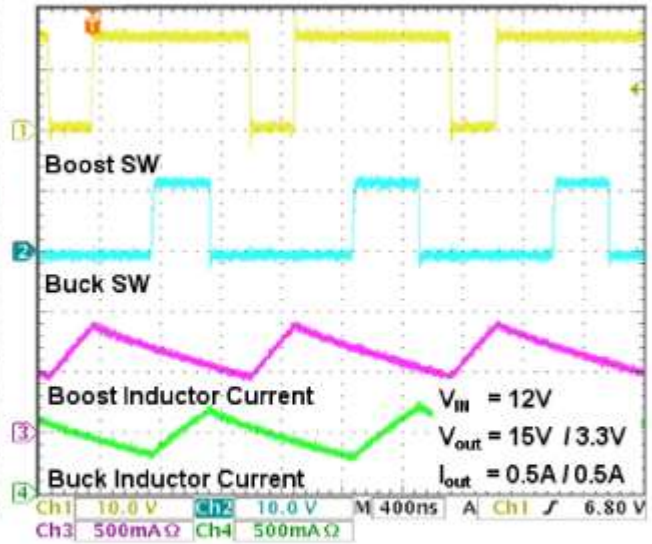

Figure 14.

EFFICIENCY BUCK BOOST CONVERTER
vs
LOAD CURRENT

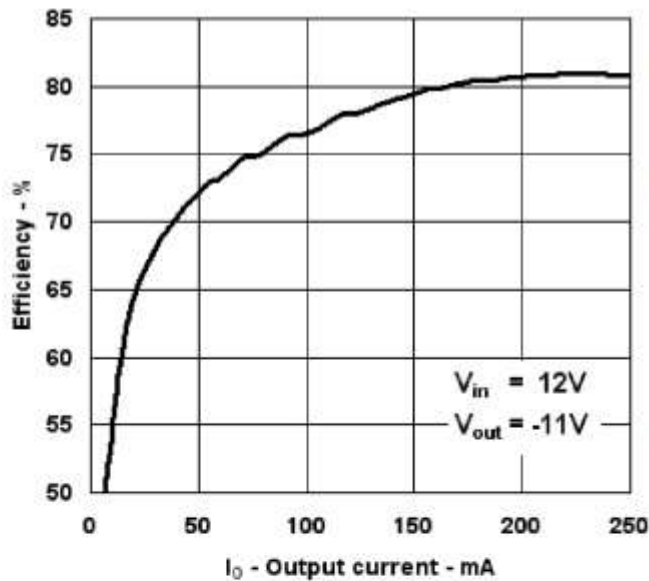

Figure 15.

PWM OPERATION AT NOMINAL LOAD CURRENT

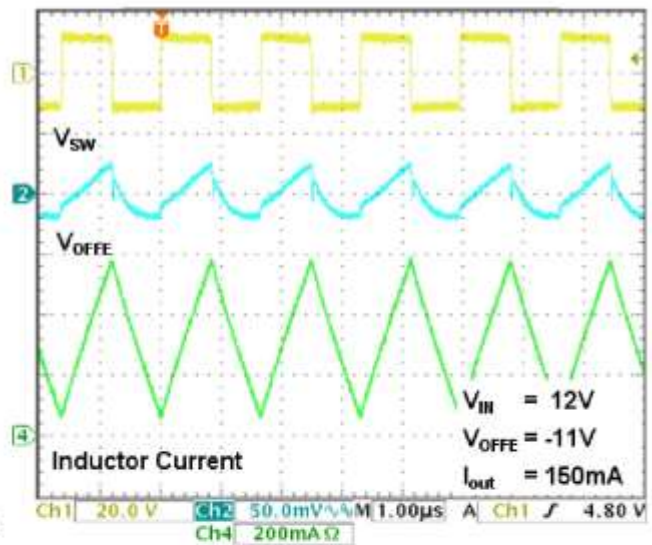

Figure 16.

PWM OPERATION AT LIGHT LOAD CURRENT

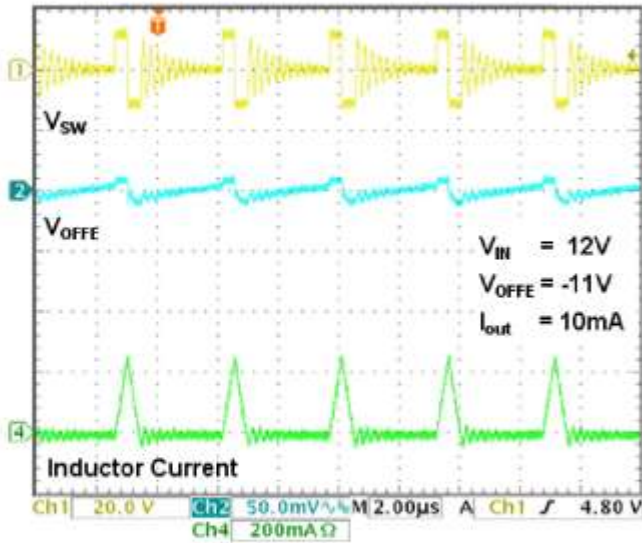

Figure 17.

LOAD TRANSIENT RESPONSE BUCK BOOST CONVERTER

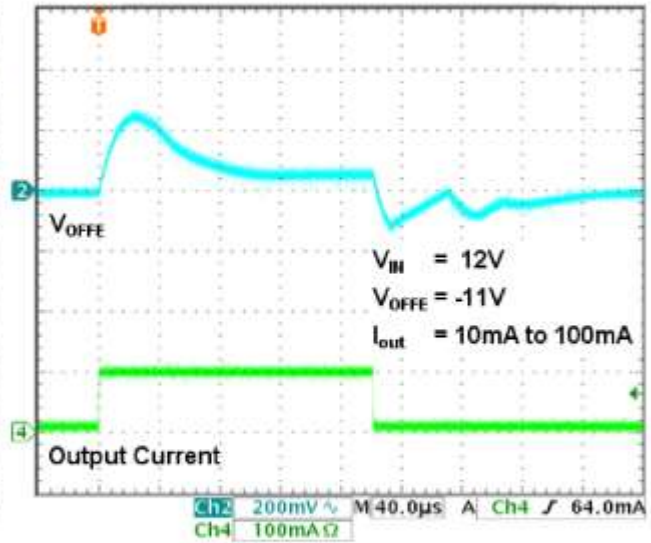

Figure 18.

LOAD TRANSIENT RESPONSE POSITIVE CHARGE PUMP $V_s=15V$

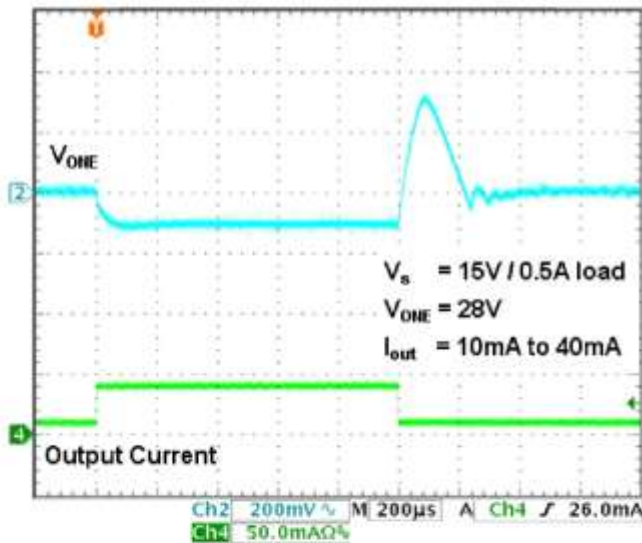

Figure 19.

LOAD TRANSIENT RESPONSE POSITIVE CHARGE PUMP $V_s=18V$

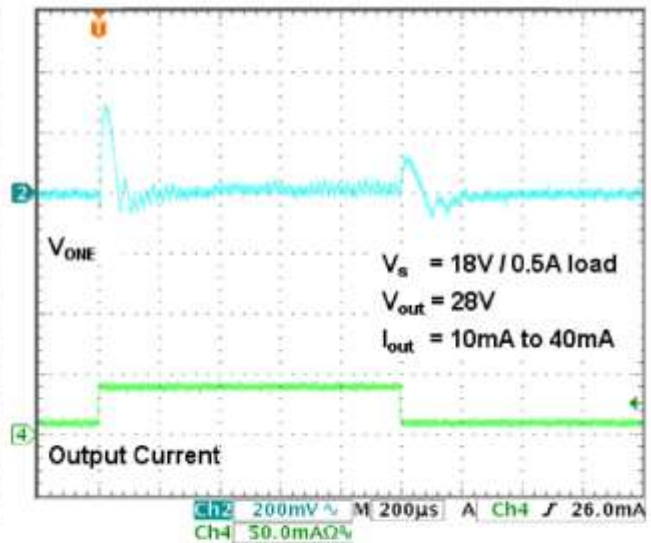

Figure 20.

LOAD TRANSIENT RESPONSE NEGATIVE SHUNT REGULATOR

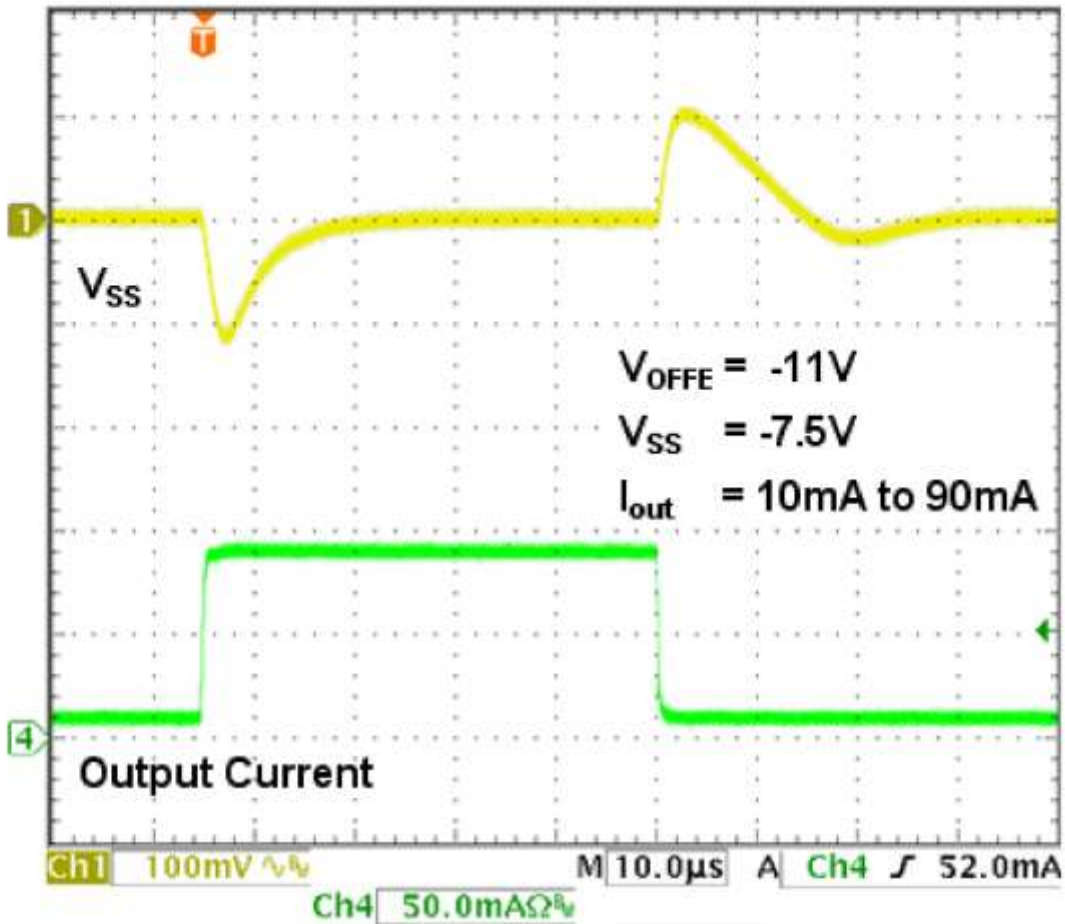

Figure 21.

APPLICATION INFORMATION

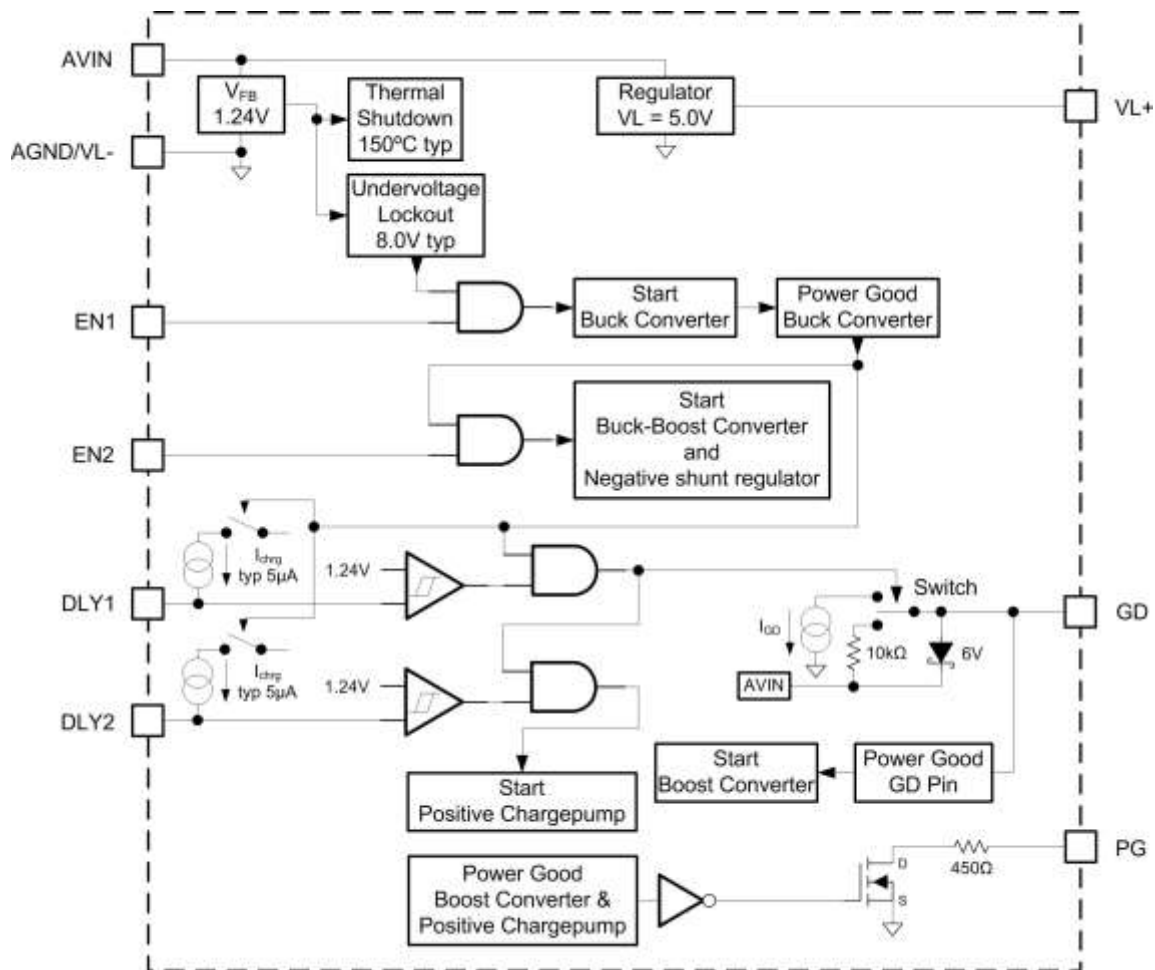

Figure 22. Control Block TPS65171

Thermal Shutdown

A thermal shutdown is implemented to prevent damages because of excessive heat and power dissipation. Once a temperature of typically 150°C is exceeded the device enters shutdown. It enables again if the temperature drops below the threshold temperature of typically 135 °C and does normal startup.

Undervoltage Lockout

To avoid mis-operation of the device at low input voltages an undervoltage lockout is included, which shuts down the device at voltages lower than typically 8.0V.

Short Circuit Protection

The positive charge pump controller V_{ONE} will run with reduced current (typ. 50µA) and disables the boost converter if short circuit is detected (FB4 falls below 100 mV). An exception is made at startup. If V_{ONE} has once passed the short level threshold (FB4 is above 100 mV), the boost converter will not be disabled until Power Good of V_{ONE} has been detected. In case there is already a short when the device is activated the charge pump controller V_{ONE} will run with reduced current and the boost converter will not start until the short is removed and V_{ONE} passes the short level threshold.

The buck converter detects a short circuit if FB2 falls below 400 mV and the whole device except the buck converter itself is shut down as if EN2 would be disabled. The switching frequency of the buck converter is reduced to 1/4th of the normal operation frequency. If the short is removed the buck converter will start operation again and the whole device auto recovers to normal operation by doing startup sequencing as if EN2 would be enabled.

The negative buck boost converter V_{OFFE} has a short circuit protection where the switch current is limited to typically 300 mA and switching frequency is reduced to about 150 kHz. A short is detected if V_{OFFE} rises above -3 V

The shunt regulator V_{SS} has no short circuit protection.

Start-Up Sequencing

The device has adjustable start-up sequencing to provide correct sequencing as required by the display.

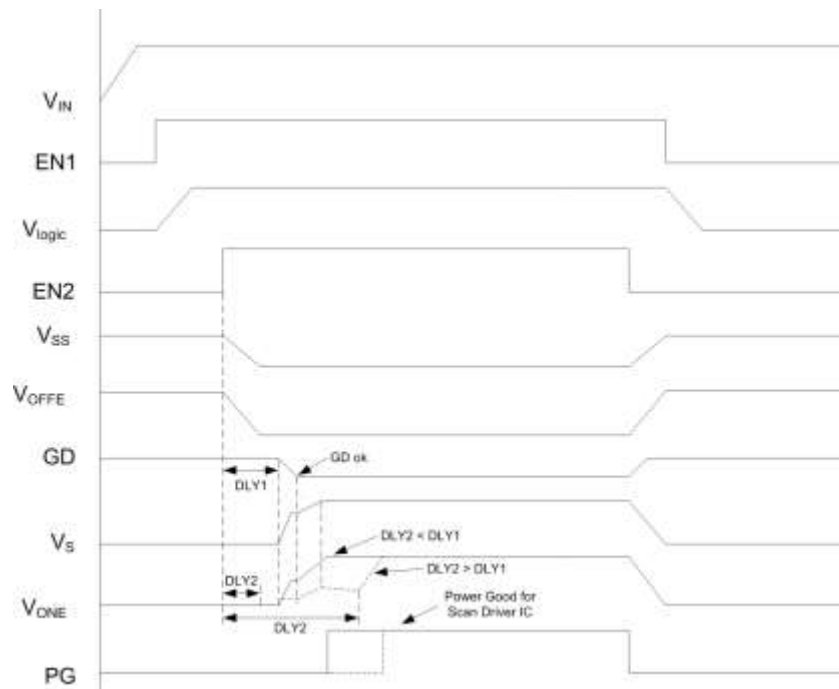

Figure 23. Power Up Sequencing

EN1 enables the buck converter.

EN2 enables the negative buck boost converter V_{OFFE} and V_{SS} at the same time. DLY1 sets the delay time for the boost converter V_S and DLY2 sets the delay time for V_{ONE} . V_{ONE} does not start until DLY1 is elapsed. For simultaneous startup of V_S and V_{ONE} , DLY2 should be set to 0 by not connecting the DLY2 pin. Once V_S and V_{ONE} are in regulation, PG goes high impedance to enable the scan driver IC.

Power Good Output

The power good output PG is an open drain output with typically 450Ω resistance and requires a pull-up resistor to the 3.3V rail. The power good goes high impedance when the V_S and V_{ONE} voltage rails are in regulation and provides an enable signal for the external scan driver IC. Once power good is high impedance, the signal is latched until V_S or V_{ONE} detect a short circuit.

The resulting maximum PG voltage if PG is low is dependent on R22 connection voltage (V_{logic}) and R22 value. To calculate maximum resulting PG voltage for power bad signal use following formula:

$$V_{PG_low} \approx \frac{450 \Omega \cdot V_{logic}}{450 \Omega + R22} \quad (1)$$

The resulting PG voltage if PG pin is high impedance is dependent on R22 connection voltage (V_{logic}), R22 value and output current I_{out} of PG node. The output current is flowing to the external scan driver. Assuming a maximum switch leakage current of 1 μ A the minimum PG output voltage can be calculated as following:

$$V_{PG_high} \approx V_{logic} - R22 \cdot (I_{leak} + I_{out}) \quad (2)$$

Recommended are R22 values between 5k Ω and 500k Ω . Typical value for R22 is 10k Ω .

Setting the Delay Times DLY1, DLY2

Connecting an external capacitor to the DLY1 and DLY2 pins sets the delay time. The capacitor is charged with a constant current source of typically 5 μ A. The delay time is terminated when the capacitor voltage has reached the threshold voltage of $V_{th} = 1.24V$. If no capacitor is set, the delay time is zero. The external capacitors can be calculated as follows:

$$C_{DLY} = \frac{5 \mu A \cdot DLY}{1.24 V}, \text{ with DLY} = \text{Desired delay time} \quad (3)$$

Example for setting a delay time of 2.5ms:

$$C_{DLY} = \frac{5 \mu A \cdot 2.5 ms}{1.24 V} = 10.1 nF \quad \text{CDLY} = 10 nF \quad (4)$$

Boost Converter

The non-synchronous current mode boost converter operates in Pulse Width Modulation (PWM) operation with a fixed frequency of 750 kHz. For maximum flexibility and stability with different external components the converter uses external loop compensation. At start up the boost converter starts with an externally adjustable soft-start. The boost converter provides the supply voltage for the LCD source driver as well as for the charge pump regulator V_{ONE} . This needs to be taken into account when defining the output current requirements for the boost converter. No feed-forward capacitor is needed for proper operation.

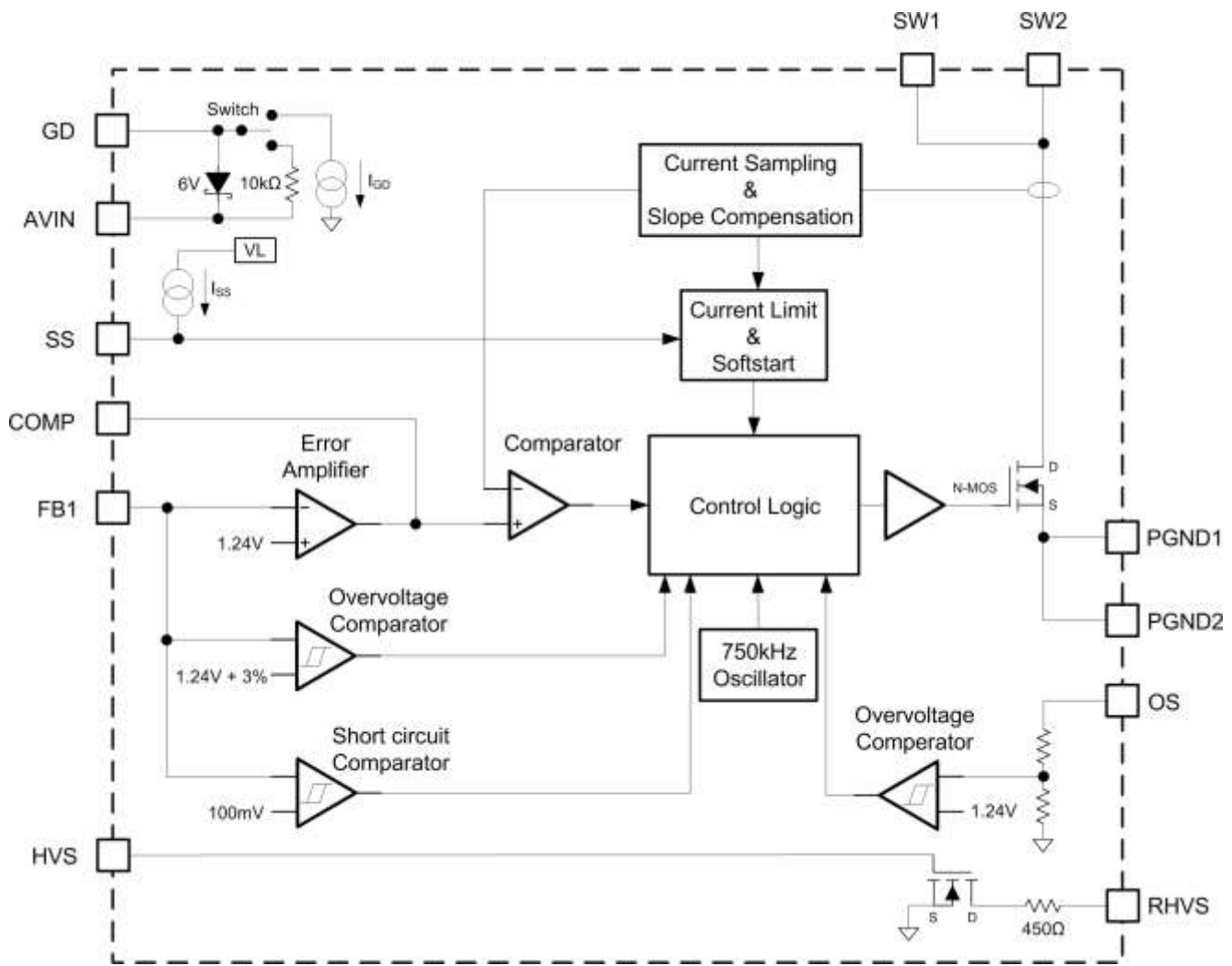

Figure 24. Boost Converter Block Diagram

Soft-Start (Boost Converter)

To avoid high inrush current during start-up an internal soft-start is implemented. The soft-start time is set by an external capacitor connected to the SS pin. The capacitor is charged with a constant current of typically 10 μA, which increases the voltage at the SS pin. The internal switch current limit is proportional to the SS pin voltage and rises with rising voltage until V_s is in regulation or the maximum current limit is reached. The larger the soft-start capacitor value the longer the soft-start time. For a 100nF capacitor at the SS pin, the current limit is reached after 0.9ms. An estimation of the current limit slope $\frac{dI_{inductor}}{dt}$ and C_{SS} capacitor can be made by the following formulas.

$$\frac{dI_{inductor}}{dt} = \frac{0.43}{C_{SS}} \left\{ \frac{mA^2}{V} \right. \quad C_{SS} = \frac{0.43 \int dt}{I_{inductor}} \left\{ \frac{mA^2}{V} \right. \quad (5)$$

Compensation (Boost Converter)

The regulator loop can be compensated by adjusting the external components connected to the COMP pin. The typical value of R4 = 33k and C5 = 1nF is appropriate for most applications. Choosing R4 = 36k compensates the boost converter more aggressive and may cause instability for low output capacitance. The below formula calculates at what frequency the resistor R4 increases the high frequency gain.

$$f_z \approx \frac{1}{2 \times R4 \times C5} \tag{6}$$

Gate Drive Pin (GD) and Isolation Switch Selection

The external isolation switch disconnects the boost converter once the device is turned off. If the boost converter is enabled by EN2 and the delay time set by DLY1 passed by, the gate pin GD is pulled low by an internal 10mA current sink to minimize inrush current until the Gate-Source voltage is clamped at about VIN -6 V. An internal 10k pull up resistor to VIN is connected to GD to open the isolation switch if the Gate Drive is disabled. Using a gate drain capacitor of typically 1 nF allows to increase the turn on time of the MOSFET for further inrush current minimization. If the boost feedback voltage falls below 100mV for more than 1.4 ms, GD is pulled high and the boost converter shuts down. The device does not recover automatically from shut down but Enable or undervoltage lockout must be toggled. Using this configuration allows to optimize the solution to specific application requirement and different MOSFETs can be used. A standard P-Channel MOSFET with a current rating close to the maximal used switch current of the boost converter is sufficient. The worst case power dissipation of the isolation switch is the maximal used switch current x RDS(on) of the MOSFET. A standard SOT23 package or similar is able to provide sufficient power dissipation.

Table 1. Isolation Switch Selection

COMPONENT SUPPLIER	CURRENT RATING
Vishay Siliconix Si3443CDV	4.7 A / 60 mΩ
Vishay Siliconix Si3433DS	6 A / 38 mΩ
International Rectifier IRLML6402	3.7 A / 65 mΩ

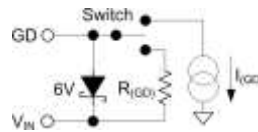

Figure 25. GD Drive

High Voltage Stress Test (HVS)

The device has a high voltage stress test. This allows programming the boost converter output voltage Vs higher by the resistor connected to RHVS once HVS is pulled high. With HVS = high the RHVS pin is switched to GND. The resistors R2 and R3 are connected parallel and therefore the overall resistance is reduced. This changes the output voltage during the High Voltage Stress Test to a higher value:

$$V_{s_{HVS}} = V_{FB1} \frac{R1 + R2 || R3}{R2 || R3} = 1.24V \frac{R1 + R2 || R3}{R2 || R3} \tag{7}$$

$$R3 = \frac{R1 \cdot R2}{\frac{V_{SHVS}}{V_{FB}} - R1} = \frac{R1 \cdot R2}{\frac{1.24V}{V_{FB}} - R1} \tag{8}$$

With:

VsHVS = Boost converter output voltage with HVS high

Overvoltage Protection

The boost converter has two overvoltage protection mechanisms for the switch. V_s is monitored with an overvoltage protection comparator on the OS pin and as soon as 19.5V typical is reached, the boost converter stops switching. The converter also detects overvoltage if the feedback voltage at the feedback pin FB1 is 3% above the typical regulation voltage of 1.24V, which stops switching. The converter starts switching again if the output voltage falls below the overvoltage thresholds.

Input Capacitor Selection

For good input voltage filtering, low ESR ceramic capacitors are recommended. All input voltages (AVIN, VIN1, 2, 3) are shorted internally. It is recommended to short AVIN, VIN1, and VIN2 externally on the PCB by a thick conducting path to avoid high currents between the VIN pins inside the device and to place one 10 μ F input capacitor as close as possible to these pins. Another 10 μ F input capacitor should be placed close to VIN3. For better input voltage filtering the input capacitor values can be increased. If it is not possible to place the 10 μ F capacitor close to the device, it is recommended to add an additional 1 μ F or 4.7 μ F capacitor which should be placed next to the input pins. To reduce power losses at the external isolation switch, a filter capacitor C3 at the input terminal of the inductor is required. To minimize possible audible noise problems, one 10 μ F capacitor in parallel is recommended. More capacitance further reduces the ripple current across the isolation switch. See [Table 2](#) for input capacitor selection.

Table 2. Input Capacitor Selection

CAPACITOR	COMPONENT SUPPLIER
10 μ F/16V	Murata, GRM31CR71C106KAC7
10 μ F/16V	Taiyo Yuden, EMK325BJ106MN
10 μ F/16V	Murata, GRM31CR61C106KA88

Boost Converter Design Procedure

The first step in the design procedure is to verify whether the maximum possible output current of the boost converter supports the specific application requirements. To simplify the calculation, the fastest approach is to estimate the converter efficiency by taking the efficiency numbers from the provided efficiency curves or to use a worst case assumption for the expected efficiency, e.g., 90%. The calculation must be made with the minimum assumed input voltage where peak switch current is the highest. The inductor and external Schottky diode has to be able to handle this current.

1. Converter Duty Cycle:
$$D = 1 \frac{V_{in}}{V_{out}}$$
2. Maximum output current:
$$I_{out} = I_{swpeak} - \frac{V_{in} \times D}{2fsL} \eta$$
3. Peak switch current:
$$I_{swpeak} = \frac{V_{in} \times D}{2fsL} + \frac{I_{out}}{\eta}$$
 (9)

With,

I_{swpeak} = Converter peak switch current (minimum switch current limit = 2.5 A)

fs = Converter switching frequency (typical 750 kHz)

L = Selected inductor value

η = Estimated converter efficiency (use the number from the efficiency curves or 0.9 as an assumption)

Inductor Selection (Boost Converter)

The boost converter is able to operate with 6.8µH to 15µH inductors, a 10µH inductor is typical. The main parameter for inductor selection is the saturation current of the inductor, which should be higher than the peak switch current as calculated in the Design Procedure section with additional margin to cover for heavy load transients. The alternative more conservative approach is to choose an inductor with saturation current at least as high as the minimum switch current limit of 2.5A. Another important parameter is the inductor dc resistance. Usually the lower the dc resistance the higher the efficiency. For a boost converter where the inductor is the energy storage element, the type and core material of the inductor influences the efficiency as well. The efficiency difference among inductors can vary up to 10%. Possible inductors are shown in [Table 3](#).

Table 3. Inductor Selection Boost Converter

INDUCTOR VALUE	COMPONENT SUPPLIER	SIZE (LxWxH mm)	Isat/DCR
10µH	Sumida CDRH5D28R/HP	6.2 × 6.2 × 3.0	2.5 A/74 mΩ
10µH	Sumida CDRH6D26/HP	7 × 7 × 2.8	2.5 A/72 mΩ
10µH	Sumida CDRH6D28	7 × 7 × 3.0	1.7 A/48 mΩ
10µH	Sumida CDRH5D28R	6.2 × 6.3 × 3.0	1.3 A/40 mΩ

Rectifier Diode Selection (Boost Converter)

To achieve high efficiency a Schottky diode should be used. The reverse voltage rating should be higher than the maximum output voltage of the boost converter. The average rectified forward current I_{avg}, the Schottky diode needs to be rated for, is equal to the output current I_{out}.

$$I_{avg} = I_{out} \tag{10}$$

Usually a Schottky diode with 2A maximum average rectified forward current rating is sufficient for most applications. The Schottky rectifier can be selected with lower forward current capability depending on the output current I_{out}, but has to be able to dissipate the power. The dissipated power is calculated according to the the following equation:

$$P_D = I_{avg} \times V_{forward} \tag{11}$$

Table 4. Rectifier Diode Selection (Boost Converter)

V _r /I _{avg}	V _{forward}	R _{θJA}	SIZE	COMPONENT SUPPLIER
20V/2A	0.38V at 2A	60°C/W	PowerDI 123	DFLS220L, DIODES Incorporated
20V/2A	0.44V at 2A	25°C/W	SMA	B220A, DIODES Incorporated
20V/2A	0.44V at 2A	75°C/W	SMB	SL22, Vishay Semiconductor

Output Capacitor Selection (Boost Converter)

For the best output voltage filtering, low ESR ceramic output capacitors are recommended. Two 22µF or four 10µF ceramic output capacitors with sufficient voltage rating in parallel are adequate for most applications. Additional capacitors can be added to improve the load transient regulation. See [Table 5](#) for output capacitor selection.

Table 5. Output Capacitor Selection (Boost Converter)

CAPACITOR	COMPONENT SUPPLIER
22µF/25V	Murata, GRM32ER61E226KE15
10µF/25V	Murata, GRM31CR61E106KA12
10µF/50V	Taiyo Yuden, UMK325BJ106MM

Setting the Output Voltage (Boost Converter)

The output voltage is set by an external resistor divider. A minimum current of 100 μA through the feedback divider provides good accuracy and noise covering. The resistors are calculated as:

$$V_s = V_{FB1} \times \left(1 + \frac{R1}{R2}\right) = 1.24 \text{ V} \times \left(1 + \frac{R1}{R2}\right) \quad (12)$$

$$R2 = \frac{V_{FB1}}{100 \mu\text{A}} = \frac{1.24 \text{ V}}{100 \mu\text{A}} \approx 12 \text{ k}\Omega \quad (13)$$

$$R1 = R2 \times \left(\frac{V_s}{V_{FB1}} - 1\right) = R2 \times \left(\frac{V_s}{1.24 \text{ V}} - 1\right) \quad (14)$$

Buck Converter

The non-synchronous current mode buck converter operates at fixed frequency PWM operation. The converter drives an internal N-channel MOSFET switch with an internal bootstrap capacitor. The output voltage can be set between 2.5V and 3.3V by an external feedback divider. If the feedback voltage FB2 is 15% above the reference voltage of 1.24V the converter stops switching and starts switching again if the FB2 voltage falls below the threshold. For 3.3V output voltage the overvoltage lockout is approximately 3.8 V.

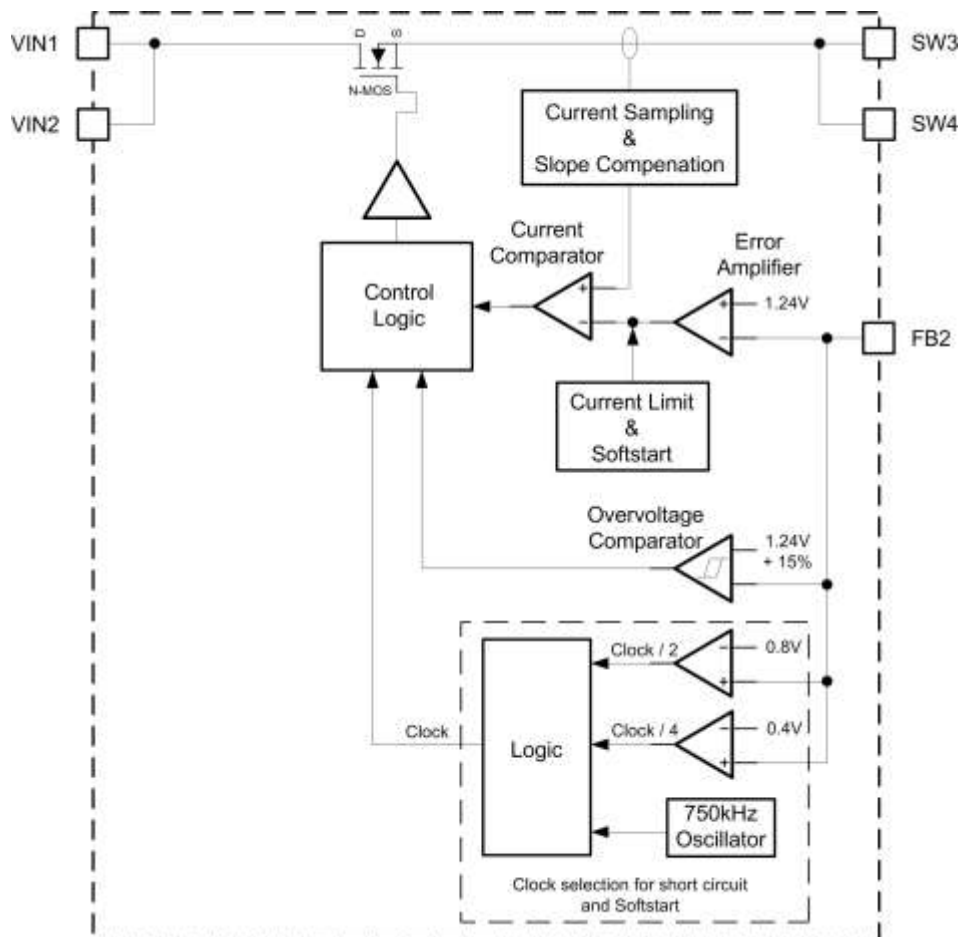

Figure 26. Buck Converter Block Diagram

Soft-Start (Buck Converter)

To avoid high inrush current during start-up, an internal soft-start is implemented. When the buck converter is enabled, its current limit is reduced and it slowly rises (1ms to 2ms) to the switch current limit. For further inrush current limitation, the switching frequency is reduced to 1/4 of the switching frequency f_s until the feedback voltage FB2 reaches 0.4V, then the switching frequency is set to 1/2 of f_s until FB2 reaches 0.8V when the full switching frequency f_s (750kHz) is applied. See the internal Block diagram (Figure 26) for further explanation. The soft-start is typically completed in 1ms to 2ms.

Buck Converter Design Procedure

The first step in the design procedure is to verify whether the maximum possible output current of the buck converter supports the specific application requirements. To simplify the calculation, the fastest approach is to estimate the converter efficiency by taking the efficiency numbers from the provided efficiency curves or to use a worst case assumption for the expected efficiency, e.g., 80%. The calculation must be for the maximum assumed input voltage where the peak switch current is the highest. The inductor and external Schottky diode have to be able to handle this current.

1. Converter Duty Cycle: $D = \frac{V_{out}}{V_{in} \times \eta}$
2. Maximum output current: $I_{out} = I_{swpeak} \times \left\{ \frac{V_{in} \times (1 - D)}{2f_s \times L} \right\} D$
3. Peak switch current: $I_{swpeak} = I_{out} + \frac{V_{in} \times (1 - D)}{2f_s \times L} \times D$ (15)

With;

- I_{swpeak} = Converter peak switch current (minimum switch current limit = 1A)
- f_s = Converter switching frequency (typical 750kHz)
- L = Selected inductor value
- η = Estimated converter efficiency (use the number from the efficiency curves or 0.8 as an assumption)

Inductor Selection (Buck Converter)

The buck converter is able to operate with 6.8µH to 15µH inductors, a 10µH inductor is typical. The main parameter for inductor selection is the saturation current of the inductor which should be higher than the maximum output current plus the inductor ripple current as calculated in the *Design Procedure* section. The highest inductor current occurs at maximum V_{IN} . The alternative more conservative approach is to choose an inductor with saturation current at least as high as the minimum switch current limit of 1A. Another important parameter is the inductor dc resistance. Usually the lower the dc resistance the higher the efficiency; the type and core material of the inductor influences the efficiency as well. The efficiency difference among inductors can vary up to 10%. Possible inductors are shown in Table 6.

Table 6. Inductor Selection Buck Converter

INDUCTOR VALUE	COMPONENT SUPPLIER	SIZE (LxWxH mm)	Isat/DCR
10µH	Sumida CDRH3D23	3.9 × 3.9 × 2.5	0.85A/95mΩ
10µH	Sumida CDRH3D28	4.0 × 4.0 × 3.0	1.1A/116mΩ
10µH	Sumida CDRH4D22	5.0 × 5.0 × 2.4	0.8A/79mΩ

Rectifier Diode Selection (Buck Converter)

To achieve high efficiency, a Schottky diode should be used. The reverse voltage rating should be higher than the maximum output voltage of the buck converter. The average rectified forward current I_{avg} , the Schottky diode needs to be rated for, is calculated as the off time of the buck converter times the output current.

$$I_{avg} = I_{out} \times (1 - D) \tag{16}$$

Usually a Schottky diode with a 1A maximum average rectified forward current rating is sufficient for most applications. The Schottky rectifier can be selected with lower forward current capability depending on the output current I_{out} , but has to be able to dissipate the power. The dissipated power is the average rectified forward current times the diode forward voltage. The efficiency rises with lower forward voltage.

$$P_D = I_{avg} \times V_{forward} \quad (17)$$

Table 7. Rectifier Diode Selection (Buck Converter)

V_r/I_{avg}	Vforward	$R_{\theta JA}$	SIZE	COMPONENT SUPPLIER
20V/1A	0.46V at 1A	20°C/W	SMA	B120, DIODES Incorporated
20V/0.5A	0.44V at 0.5A	150°C/W	SOT123	MBR0520, International Rectifier
20V/1A	0.32V at 1A	60°C/W	PowerDI 123	DFLS120L, DIODES Incorporated

Output Capacitor Selection (Buck Converter)

For best output voltage filtering, low ESR ceramic output capacitors are recommended. Two 22 μ F or four 10 μ F ceramic output capacitors with sufficient voltage rating in parallel are adequate for most applications. Additional capacitors can be added to improve the load transient regulation. See [Table 8](#) for output capacitor selection.

Table 8. Output Capacitor Selection (Buck Converter)

CAPACITOR	COMPONENT SUPPLIER
22 μ F/6.3V	Murata, GRM31CR60J226KE19
10 μ F/6.3V	Murata, GRM21BR70J106KE76
47 μ F/6.3V	Murata, GRM32ER60J476ME20
10 μ F/6.3V	Taiyo Yuden, JWK212BJ106MD

Setting the Output Voltage (Buck Converter)

The output voltage is set by an external resistor divider. R6 should be chosen in the range of 0.5k Ω to 4.7k Ω . For good noise covering and accuracy the lower feedback resistor R6 is selected to obtain at least a 250 μ A minimum load current.

$$V_{logic} = V_{FB2} \times \left\{ 1 + \frac{R5}{R6} \right\} = 1.24 \text{ V} \times \left\{ 1 + \frac{R5}{R6} \right\} \quad (18)$$

$$R6 = \frac{V_{FB2}}{1 \text{ mA}} = \frac{1.24 \text{ V}}{1 \text{ mA}} \approx 1.2 \text{ k}\Omega \quad (19)$$

$$R5 = R6 \times \left\{ \frac{V_{logic}}{V_{FB2}} - 1 \right\} = R6 \times \left\{ \frac{1.24 \text{ V}}{1.24 \text{ V}} - 1 \right\} \quad (20)$$

Negative Buck-Boost Converter V_{OFFE} , Temperature Compensation

The non-synchronous constant off-time current mode buck-boost converter generates the negative V_{OFFE} voltage rail. This output rail is required to power the scan driver. The output voltage is temperature compensated and fully adjustable from –22V to –5V. The external resistor divider on pins FB5 and SET allow programming high and low voltage levels. The graph below shows the output voltage versus temperature in $^{\circ}$ C and series resistor R19 (5k Ω to 7.5k Ω). NTC (22k Ω) and R18 (30k Ω) define the slope of the curve, R19 allows selection of the temperature point where temperature compensation begins and ends. The converter is compensated internally, for further stabilization the feed-forward capacitor C22 can be chosen between 100pF and 3nF. Soft-start is also realized with this capacitor. The larger the capacitor value the longer the soft-start time. The recommended C22 value is 2.2nF.

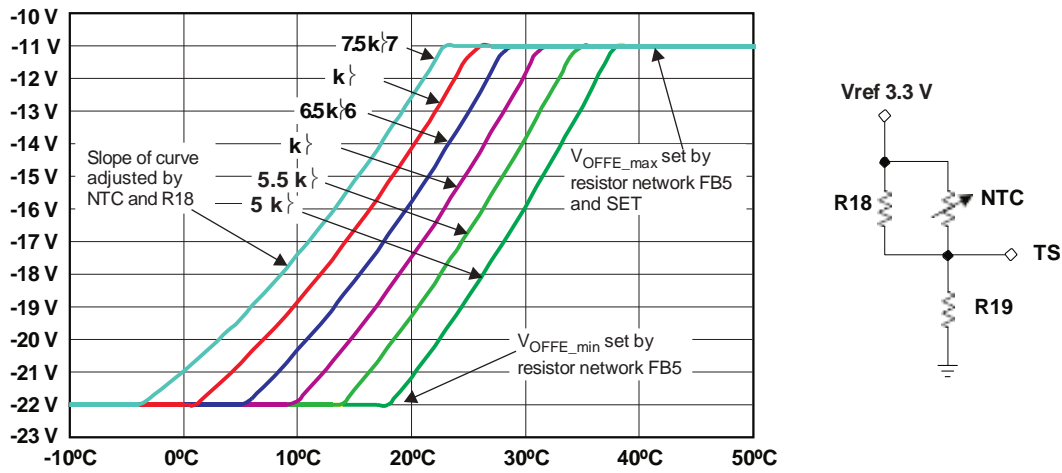

Figure 27. V_{OFFE} Temperature Compensation

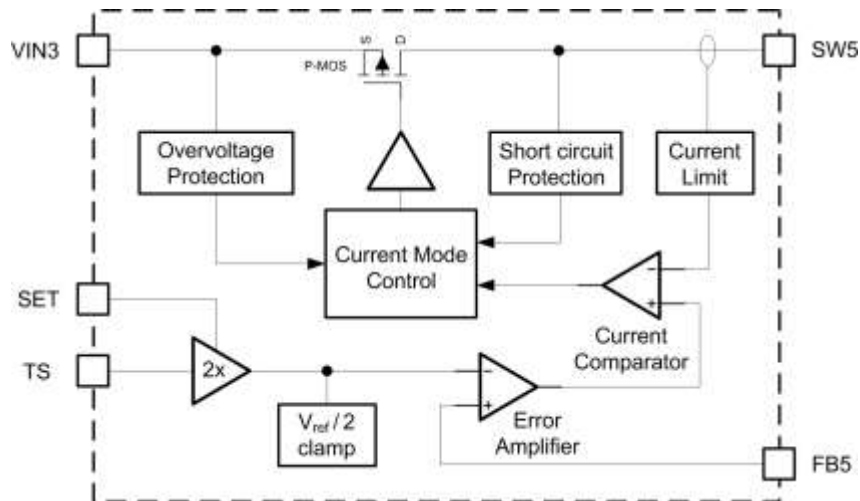

Figure 28. Buck-Boost Converter Block Diagram

Setting the Minimal and Maximal Output Voltage, V_{OFFE}

Keep in mind that V_{OFFE} has a negative value, while V_{logic} and V_{SET} have positive values:

$$V_{OFFE_min} = \frac{V_{logic}}{2} \times \frac{R21}{R20} = 1.65 \text{ V} \times \frac{R21}{R20}, \text{ select } R21 \text{ about } 1 \text{ M}\Omega \text{ to achieve good soft-start.} \quad (21)$$

$$R20 = \frac{V_{logic} \times R21}{V_{logic} \times 2 \times V_{OFFE_min}} = \frac{3.3 \text{ V} \times R21}{3.3 \text{ V} \times 2 \times V_{OFFE_min}} \quad (22)$$

$$V_{OFFE_max} = V_{SET} - (V_{logic} - V_{SET}) \times \frac{R21}{R20} = V_{SET} - (3.3 \text{ V} - V_{SET}) \times \frac{R21}{R20}, \text{ } V_{SET} \text{ is calculated below.} \quad (23)$$

$$V_{SET} = \frac{V_{OFFE_max} \times R20 + V_{logic} \times R21}{R20 + R21} = \frac{V_{OFFE_max} \times R20 + 3.3 \text{ V} \times R21}{R20 + R21} \quad (24)$$

$$V_{SET} = V_{logic} \times \frac{R17}{R16 + R17} = 3.3 \text{ V} \times \frac{R17}{R16 + R17}, \text{ select } R17 \text{ between } 1 \text{ k}\Omega \text{ and } 20 \text{ k}\Omega \text{ for good accuracy.} \quad (25)$$

$$R16 = R17 \times \frac{V_{logic}}{V_{SET}} = R17 \times \frac{3.3 \text{ V}}{V_{SET}} \quad (26)$$

Setting the Start and End Temperature of the Compensation

The resistance of a NTC thermistor decreases nonlinearly with rising temperature.

$$R_{NTC}(T) = R_{T_0} \times e^{-B \times \left(\frac{1}{T} - \frac{1}{T_0} \right)} \quad (27)$$

Where,

R_{T_0} is the resistance at an absolute temperature T_0 in Kelvin (normally 25°C)

T is the temperature in Kelvin (°C + 273.15 K/°C)

B is a material constant

The NTC thermistor manufacturer provides the above parameters. Typically a 22k Ω NTC is used. [Table 9](#) provides a suggestion for NTCs.

Table 9. Negative Thermistor Selection

RESISTANCE (25°C)	B CONSTANT	COMPONENT SUPPLIER	COMMENT
22k Ω	3950 K	Murata, NCP18XW223E	±3%
22k Ω	3800 K	Vishay, NTCS0805E3223FHT	±1%
22k Ω	4554 K	TDK, NTCG164LH223HT	±3%

To linearize the resistance-temperature characteristic of the NTC thermistor, a parallel resistor $R18$ is added. T is the temperature at which the NTC characteristic curve is linearized. Typically T is located in the middle of the set temperature range at which the V_{OFFE} voltage should be adjusted. For example, if the temperature compensation should start at 0°C and stop at 25°C $T = 12.5^\circ\text{C} + 273.15 \text{ K}/^\circ\text{C} = 285.65 \text{ K}$.

$$R18 = R_{NTC}(T) \times \frac{B}{B + 2T} \quad (28)$$

The resulting overall resistance $R_{NTC||R18}$ can be calculated as follows.

$$R_{NTC||R18} = \frac{R18 \times R_{NTC}(T)}{R18 + R_{NTC}(T)} \quad (29)$$

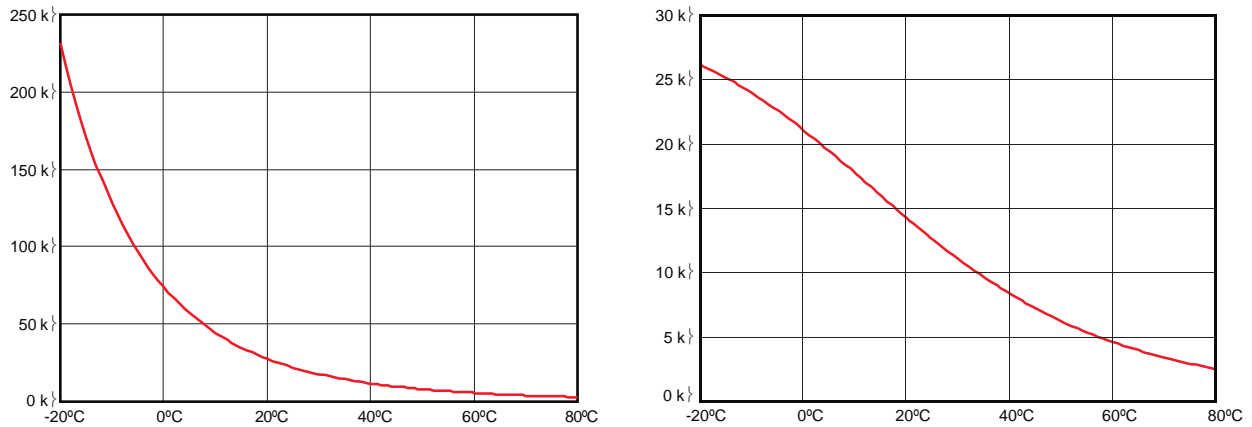

Figure 29. Resistance-Temperature Characteristics NTC (22 kΩ) and Linearized NTC Network at 12.5°C

To achieve different slopes, different R18 values are required. To obtain the most linear slope, the calculated value has to be used. To achieve steeper slopes, higher values for R18 are necessary, smaller values produce shallower slopes. By adjusting the resistor R19, the start and end point of the compensation can be set. The voltage V_{TS} of the resistor network at TS is calculated by the following equation:

$$V_{TS} = V_{logic} \left\{ \frac{R19}{R_{NTC||R18} + R19} = 3.3 V \right\} \frac{R19}{R_{NTC||R18} + R19} \tag{30}$$

Finally, the resulting output voltage, V_{OFFE} , during the compensation period can be calculated as follows:

$$V_{OFFE} = 2V_{TS} - (V_{logic} - 2V_{TS}) \left\{ \frac{R21}{R20} = 2V_{TS} - (3.3V - 2V_{TS}) \right\} \frac{R21}{R20} \tag{31}$$

Figure 30 shows examples for $V_{OFFE_min} = -22V$ and $V_{OFFE_max} = -11V$ with different slopes and starting points of the temperature compensation. For further compensation characteristics, refer to the available TPS65171 support excel sheet.

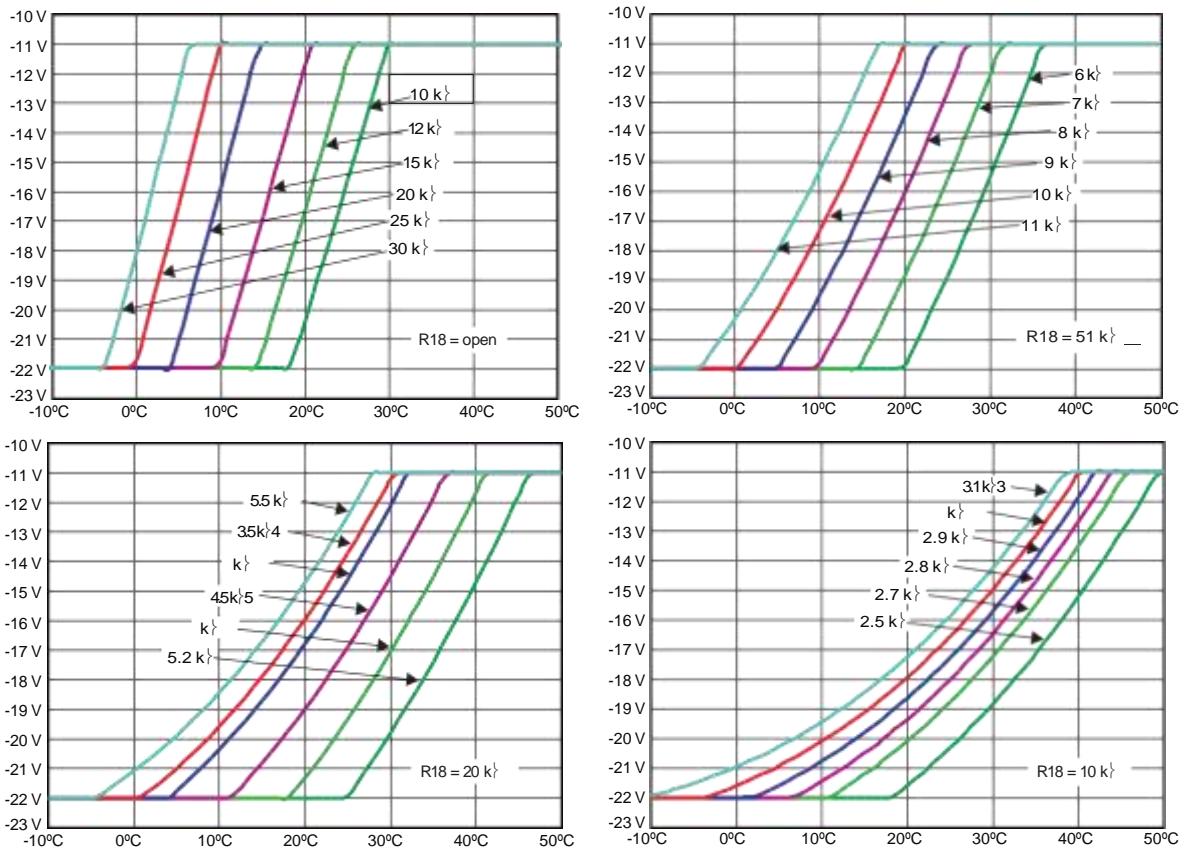

Figure 30. Temperature Compensation Examples for R18 = open, 51 kΩ, 20 kΩ, 10 kΩ

Buck-Boost Converter Design Procedure

The first step in the design procedure is to verify whether the maximum possible output current of the buck-boost converter supports the specific application requirements. To simplify the calculation, the fastest approach is to estimate converter efficiency by taking the efficiency numbers from the provided efficiency curves or to use a worst case assumption for the expected efficiency, e.g., 80%. The calculation must be performed for the minimum assumed input voltage where the peak switch current is the highest. The inductor and external Schottky diode have to be able to handle this current.

1. Converter Duty Cycle:
$$D = \frac{V_{out}}{V_{in} \times \eta}$$

2. Maximum output current:
$$I_{out} = \left\{ I_{swpeak} - \frac{V_{in} \times D}{2fs \times L} \right\} \times \eta \quad (1) \times D$$

3. Peak switch current:
$$I_{swpeak} = \frac{I_{out}}{\eta} + \frac{V_{in} \times D}{2fs \times L} \quad (32)$$

With,

I_{swpeak} = Converter peak switch current (minimum switch current limit = 0.8A)

fs = Converter switching frequency (typical 750 kHz)

L = Selected inductor value

η = Estimated converter efficiency (use the number from the efficiency curves or 0.8 as an assumption)

Inductor Selection (Buck-Boost Converter)

The buck-boost converter is able to operate with 10 μ H to 47 μ H inductors, a 22 μ H inductor is typical. The main parameter for inductor selection is the saturation current of the inductor which should be higher than the peak switch current as calculated in the Design Procedure section with additional margin to cover for heavy load transients. The alternative more conservative approach is to choose an inductor with saturation current at least as high as the minimum switch current limit of 0.8A. Another important parameter is the inductor dc resistance. Usually the lower the dc resistance the higher the efficiency. The type and core material of the inductor influences the efficiency as well. The efficiency difference among inductors can vary up to 5%. Possible inductors are listed in [Table 10](#).

Table 10. Inductor Selection Buck-Boost Converter

INDUCTOR VALUE	COMPONENT SUPPLIER	SIZE (LxWxH mm)	Isat/DCR
22 μ H	Sumida CDRH3D23/HP	4.0 × 4.0 × 2.5	0.8A/306m Ω
22 μ H	Sumida CDRH4D22/HP	5.0 × 5.0 × 2.4	1.1A/214m Ω
22 μ H	Sumida CDH3D13D/SHP	3.2 × 3.2 × 1.5	0.6A/753m Ω

Rectifier Diode Selection (Buck-Boost Converter)

To achieve high efficiency, a Schottky diode should be used. The reverse voltage rating should be higher than the maximum output voltage of the buck-boost converter. The average rectified forward current, I_{avg} , the Schottky diode needs to be rated for, is equal to the output current, I_{out} .

$$I_{avg} = I_{out} \tag{33}$$

Usually a Schottky diode with a 500mA maximum average rectified forward current rating is sufficient for most applications. The Schottky rectifier can be selected with lower forward current capability depending on the output current I_{out} , but has to be able to dissipate the power. The dissipated power is the average rectified forward current times the diode forward voltage. The efficiency rises with lower forward voltage.

$$P_D = I_{avg} \times V_{forward} \tag{34}$$

Table 11. Rectifier Diode Selection (Buck-Boost Converter)

V_f/I_{avg}	$V_{forward}$	$R_{\theta JA}$	SIZE	COMPONENT SUPPLIER
40V/0.5A	0.43V at 0.5A	206°C/W	SOD-123	MBR0540, Vishay Semiconductor
40V/1A	0.42V at 0.5A	88°C/W	SMA	SS14, Fairchild Semiconductor

Output Capacitor Selection (Buck-Boost Converter)

For the best output voltage filtering, low ESR ceramic capacitors are recommended. One 22 μ F or two 10 μ F output capacitors with sufficient voltage ratings in parallel are adequate for most applications. Additional capacitors can be added to improve load transient regulation. See [Table 12](#) for output capacitor selection.

Table 12. Output Capacitor Selection (Buck-Boost Converter)

CAPACITOR	COMPONENT SUPPLIER
22 μ F/25V	Murata, GRM32ER61E226KE15
10 μ F/25V	Murata, GRM31CR61E106KA12
10 μ F/50V	Taiyo Yuden, UMK325BJ106MM

Positive Charge Pump Regulator (V_{ONE})

This output rail is required to power the scan driver and is generated with a charge pump doubler stage running from V_s and using the switch node of the boost converter. The external PNP transistor regulates the output voltage to the programmed voltage set by the feedback resistor divider. Power dissipation and average collector current of the transistor must be taken into consideration when choosing a suitable transistor. Also the power dissipation of the resistor R12 must be considered.

Setting the Output Voltage and Selecting the Feed-Forward Capacitor (Positive Charge Pump)

To minimize noise a minimum current through the feedback divider of 500 μA is recommended. At startup the device is in short circuit mode with reduced current (typ. 50 μA) until the feedback voltage FB4 exceeds 100 mV, then the device switches to soft-start mode until the output voltage V_{ONE} is in regulation. Due to the high output current and low required voltage drop, high current Schottky diodes with low forward voltage are recommended for this regulator.

$$V_{out} = V_{FB4} \times \left\{ 1 + \frac{R14}{R15} \right\} = 1.24 V \times \left\{ 1 + \frac{R14}{R15} \right\} \quad (35)$$

$$R15 = \frac{V_{FB4}}{500 \mu A} = \frac{1.24 V}{500 \mu A} \approx 2.4 k \quad (36)$$

$$R14 = R15 \times \left\{ \frac{V_{out}}{V_{FB4}} - 1 \right\} = R15 \times \left\{ \frac{V_{out}}{1.24 V} - 1 \right\} \quad (37)$$

To minimize noise and leakage current sensitivity keep the lower feedback divider resistor R15 between 100 k and 4.7 k. See typical application section for charge pump circuit.

Across the upper feedback resistor R14, a bypass capacitor C17 is required. The capacitor is calculated as:

$$C17 = \frac{1}{2 \times 12 \text{ kHz} \times R14} \quad (38)$$

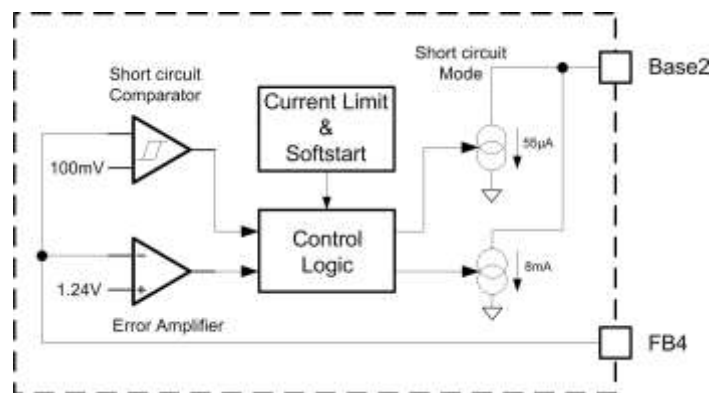

Figure 31. Positive Chargepump Block Diagram

PNP Transistor Selection (Positive Charge Pump)

The maximum possible V_{ONE} output voltage is calculated as:

$$V_{ONE} = 2 \times V_s + V_{D1} - 2 \times V_{D2} - \frac{I_{ONE}}{D} \times R \times V_Q \quad (39)$$

With:

V_s = boost converter output voltage

V_{D1} = Forward voltage of boost converter Schottky diode

V_{D2} = Forward voltage of charge pump diode for a current of I_{ONE} / D

I_{ONE} = V_{ONE} output current

D = Duty cycle of boost converter (D = 1 – Vin / Vs)

R = Series resistor (if applicable, e.g., 2 Ω for typical application)

V_Q = Transistor saturation voltage

As a general recommendation the V_{ONE} voltage level in use should be at least 0.5V lower than the calculated maximum V_{ONE} voltage.

The power dissipation of the transistor should be calculated for the maximum applied boost output voltage V_s . If high voltage stress mode (HVS) is used the maximum V_s voltage occurs during HVS mode.:

$$\text{Power dissipation} = \left\{ 2 \right\} \left\{ V_s - V_{\text{ONE}} - 2 \right\} \left\{ V_{\text{D2}} - \frac{I_{\text{ONE}}}{D} \right\} \left\{ R_{\text{e}} \right\} \times I_{\text{ONE}} \tag{40}$$

As an example for $V_s = 18\text{V}$ and $I_{\text{ONE}} = 75\text{mA}$, the power dissipation is approximately 0.5W.

Because of the 1µF collector capacitor C16 a wide range of transistors can be used. The most important transistor parameters are Collector-Emitter voltage which must be at least $2 \times V_s$, average current rating of $1.2 \times I_{\text{ONE}}$ and DC current gain h_{FE} , which must be at least $I_{\text{ONE}} / I_{\text{Base2}}$. I_{Base2} minimum value of 8mA should be used for calculation. See Table 13 for possible transistor selection.

Table 13. Transistor Selection (Positive Charge Pump)

TRANSISTOR
PZT2907A
KTA1551T
KTA1718D
KTA1666

Resistor R12 Function and Power Dissipation (Positive Charge Pump)

R12 is used to limit the peak current flowing from collector capacitor C16 through R12, D3 and C15 into the boost switching node. High peak currents disturb the boost converter switching which results in high V_s and V_{ONE} ripple. The power dissipation for the resistor R12 can be calculated by following formula:

$$P_{\text{resistor}} = R12 \times I_{\text{ONE}}^2 \tag{41}$$

Output Capacitor Selection (Positive Charge Pump)

For the best output voltage filtering, low ESR ceramic output capacitors are recommended. Two 4.7µF ceramic output capacitors with sufficient voltage rating are adequate for most applications. Additional capacitors can be added to improve the load transient regulation. See Table 14 for capacitor selection.

Table 14. Output Capacitor Selection (Positive Charge Pump)

CAPACITOR	COMPONENT SUPPLIER
4.7µF/50V	Murata, GRM31CR71H475KA12
4.7µF/50V	Taiyo Yuden, UMK316BJ475KL-T

Negative Shunt Regulator (V_{SS})

V_{SS} is a shunt regulator that regulates the non-addressed TFT pixels to the programmed voltage. The pulldown resistor R11 connected to V_{OFFE} is required to provide accurate no load current regulation. A minimum current of 50µA through the feedback divider provides good accuracy. Be aware of the negative value of V_{SS} for the calculations.

$$V_{\text{out}} = V_{\text{FB3}} + (V_{\text{FB3}} \left\{ V_{\text{logic}} \right\}) \left\{ \frac{R9}{R10} = 0.75 \right\} \left\{ V_{\text{logic}} \right\} \left\{ \frac{V_{\text{logic}} \times R9}{4 \left\{ R10 \right\}} = 2.475\text{V} \right\} \left\{ 0.825 \right\} \left\{ \frac{R9}{R10} \right\} \tag{42}$$

$$R10 = \frac{V_{\text{logic}} \left\{ 0.75 \right\} \left\{ V_{\text{logic}} \right\}}{80 \left\{ \mu\text{A} \right\}} = \frac{0.825 \text{ V}}{80 \left\{ \mu\text{A} \right\}} \left\{ 10 \text{ k} \right\} \tag{43}$$

$$R9 = \frac{V_{\text{out}} \left\{ V_{\text{FB3}} \right\}}{V_{\text{FB3}} \left\{ V_{\text{logic}} \right\}} \times R10 = \frac{V_{\text{out}} \left\{ 0.75 \right\} \left\{ V_{\text{logic}} \right\}}{\left\{ 0.25 \right\} \left\{ V_{\text{logic}} \right\}} \left\{ R10 \right\} = \frac{V_{\text{out}} \left\{ 2.475 \text{ V} \right\}}{\left\{ 0.825 \text{ V} \right\}} \times R10 \tag{44}$$

Discharge Resistor at V_{SS} Output

If a discharge resistor R_{dis} at the V_{SS} output is used to discharge the V_{SS} node faster, the pull down resistor R11 connected to V_{OFFE} must be calculated by following formula to achieve the programmed output voltage at V_{SS}. A smaller resistor to the calculated one must be used. For example for V_{SS} = -7.5V, V_{OFFE} = -11V and R_{dis} = 12kΩ the calculated R11 = 4.98kΩ and the resistor values 4.7kΩ, 4.3kΩ, and 4.0kΩ can be used.

$$R11 = \frac{R_{dis} \cdot (R9 + R10) \cdot (V_{OFFE} - V_{SS})}{V_{SS} \cdot (R_{dis} + R9 + R10) \cdot V_{logic} + R_{dis}} \quad (45)$$

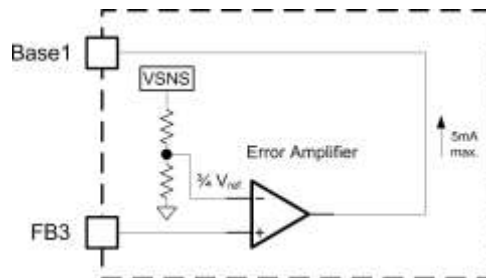

Figure 32. Negative Shunt Regulator Block Diagram

Output Capacitor Selection (Negative Shunt Regulator)

For the best output voltage filtering, low ESR ceramic output capacitors are recommended. One 1μF ceramic output capacitor with a sufficient voltage rating is suitable for most applications. See Table 15 for output capacitor selection.

Table 15. Output Capacitor Selection (Negative Shunt Regulator)

CAPACITOR	COMPONENT SUPPLIER
1μF/25V	Murata, GRM21BR71E105KA99
1μF/50V	Taiyo Yuden, UMK325BJ105KH

Layout Considerations

PCB layout is an important step in power supply design.

- NC pins 5, 8, 22, and 29 should not be connected to GND, if so, the device is not P2P short protected any more.
- The input capacitors should be placed as close as possible to the device. AVIN, VIN1, and VIN2 must be shorted.
- The buffer capacitor C25 must be connected to VL+ and AGND/VL- by a single trace.
- The line device, diode, output cap of the buck boost should be kept as short as possible.
- For the boost converter the line C3 GND output capacitor GND and PGND1 should be kept short.
- For the buck converter the line switch pin SW3, 4 to diode should be kept short.
- All lower feedback resistors connected to GND should be placed close to the device.
- Switching lines should not be next to feedback lines to avoid coupling.
- Use short lines or make sure the lines do not affect other regulating parts for the charge pump switching connection to SW1,2 because this trace carries switching waveforms.
- The PowerPAD™ of the QFN package should be soldered to GND and as much as possible thermal vias should be used to lower the thermal resistance and keep the device cool.
- A solid PCB ground plane structure is essential for good device performance.
- Place red marked components and lines first and as close as possible to the device. Keep red marked lines short. Bold marked lines should be wide on the PCB, because these traces carry high currents.
- Green marked components can be placed further away.

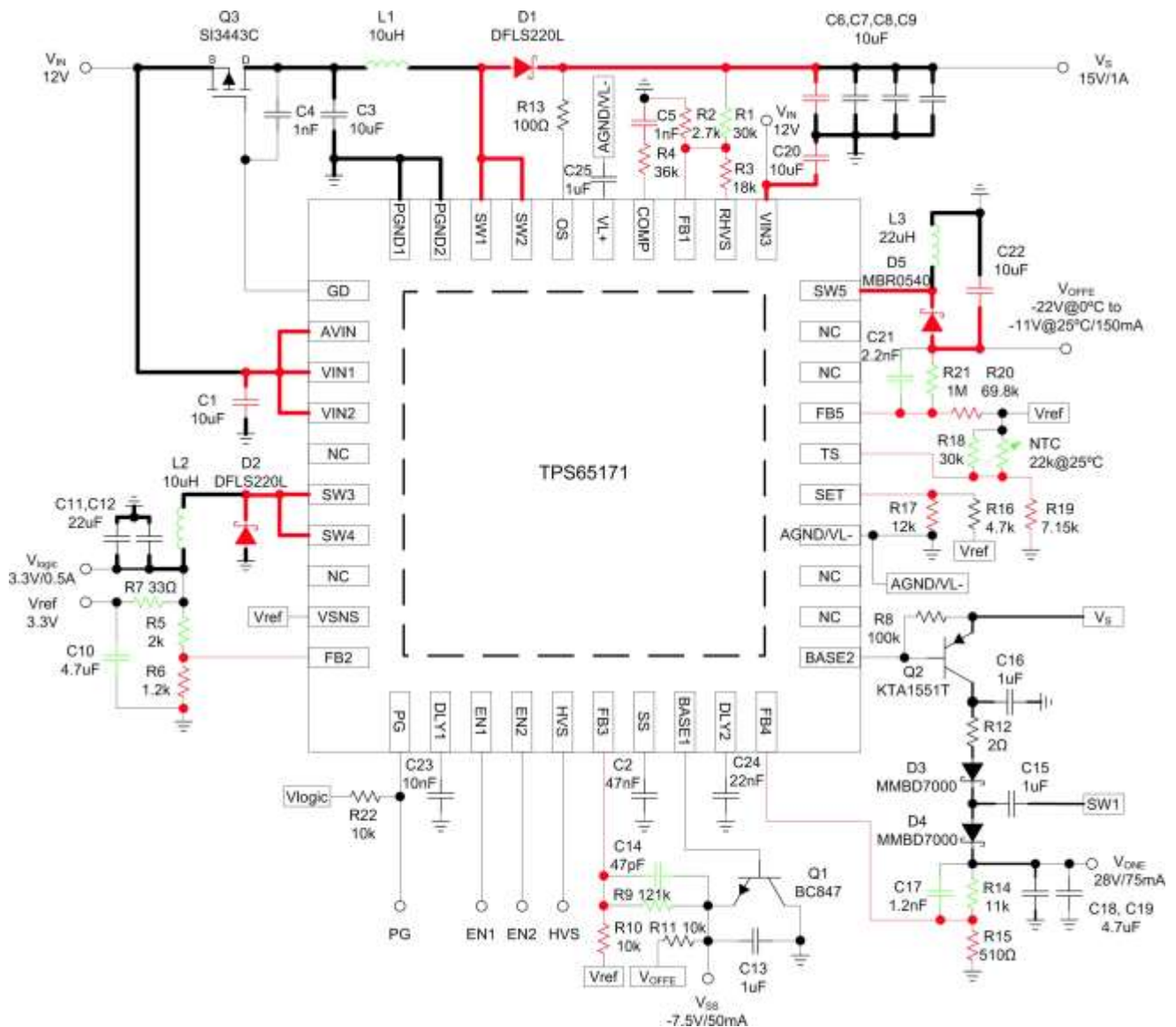

Figure 33. PCB Layout Guideline

Typical Applications

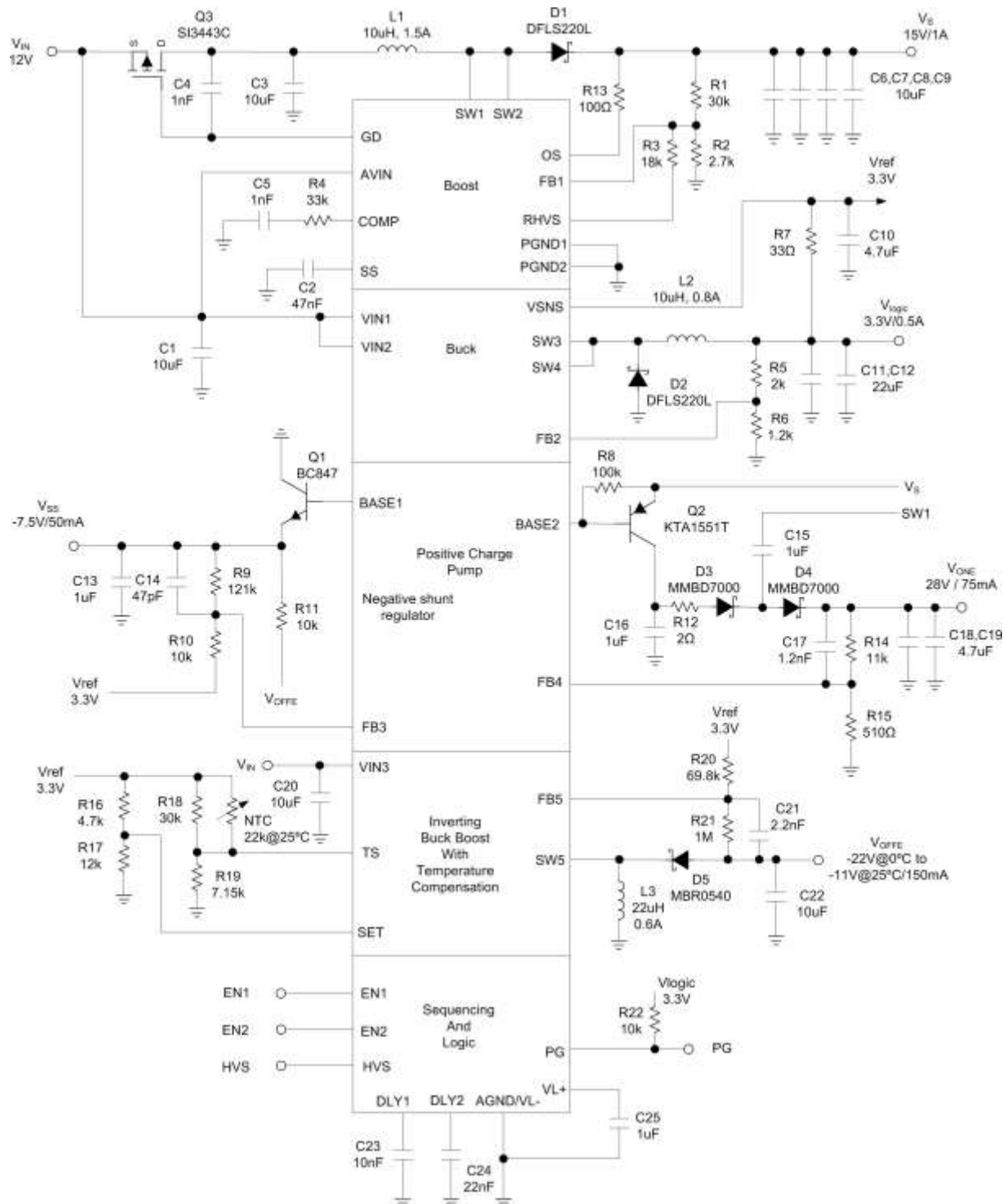

Figure 34. Typical Application With $V_S = 15V$, $HVS = 18V$, $V_{logic} = 3.3V$

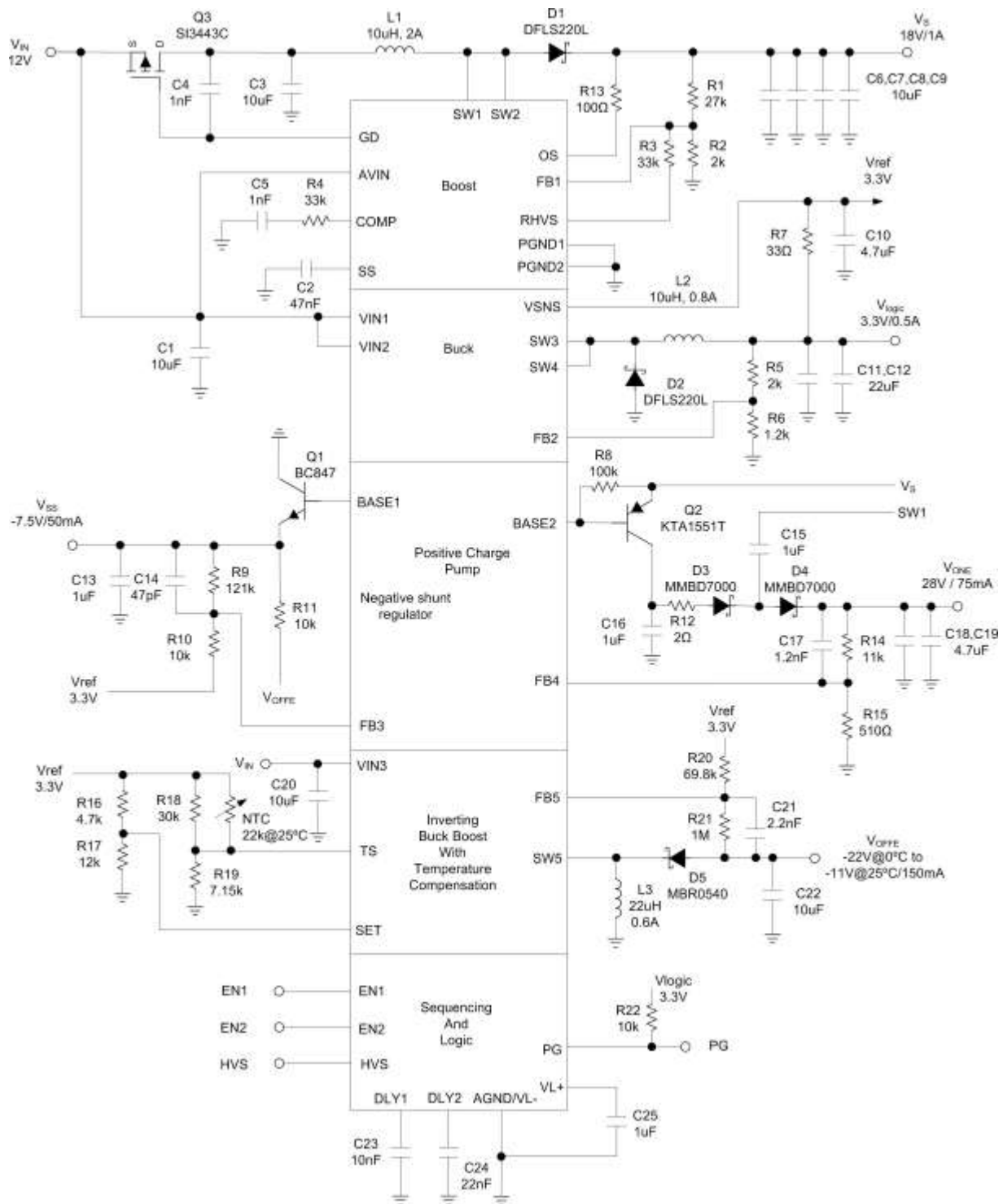

Figure 35. Typical Application With V_S = 18V, HVS = 19V, V_{logic} = 3.3V

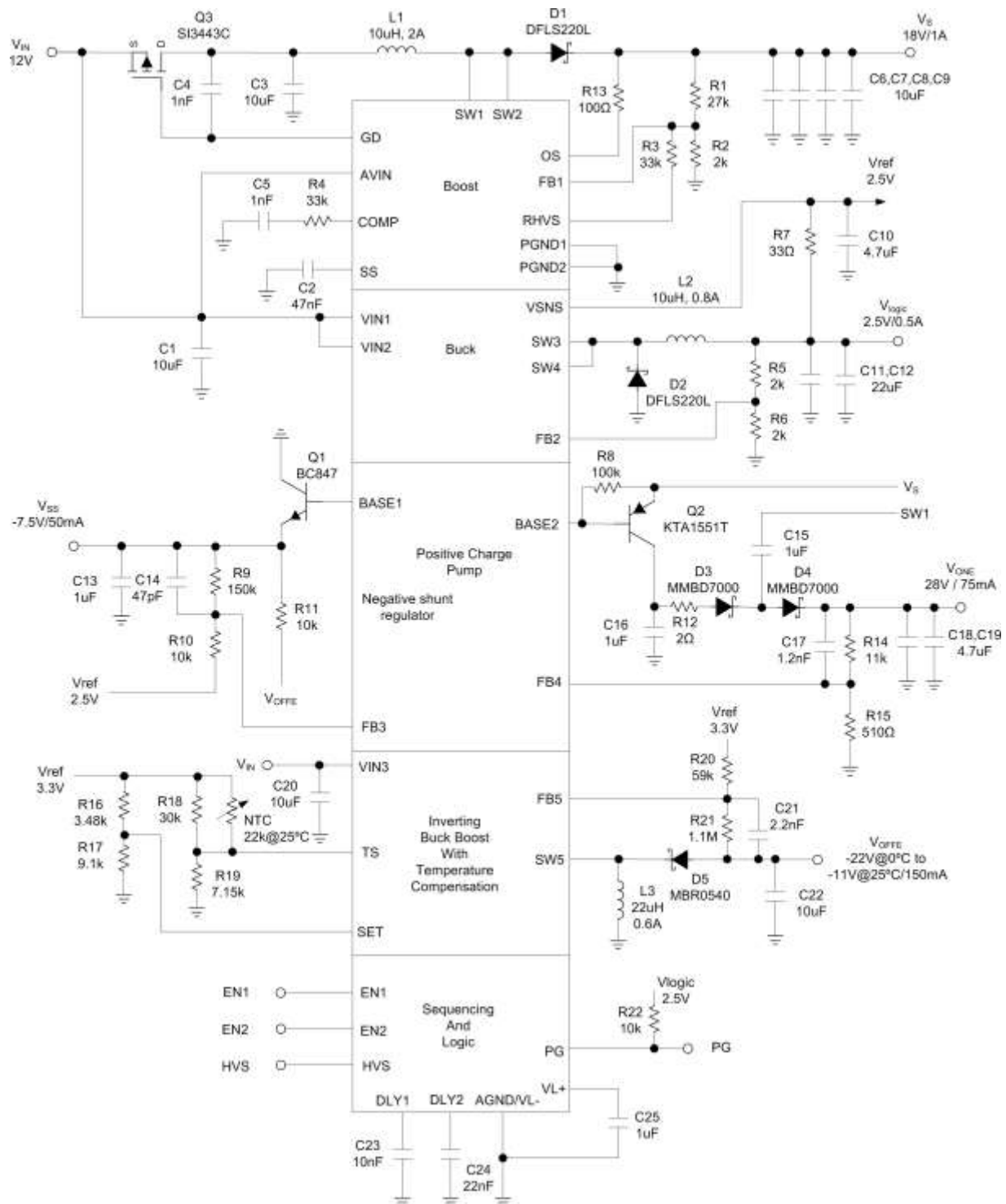

Figure 36. Typical Application With V_S = 18V, HVS = 19V, V_{logic} = 2.5V

Charge pump circuit.

Table 16. Maximum Output Current $V_{ONE} = 28V - 3\%$

V_{in}	$V_s = 15V$	$V_s \nabla 16V$
10.8 V	100mA	100mA
12.0V	85mA	100mA
13.2V	55mA	100mA

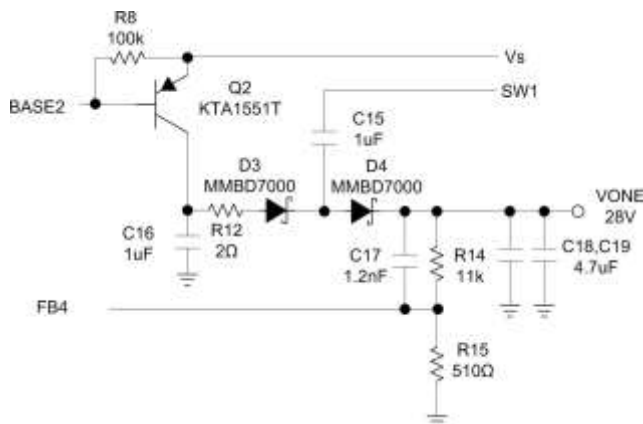

Figure 37. Typical Application V_{ONE} Output Current

REVISION HISTORY**Changes from Original (October 2009) to Revision A****Page**

-
- Changed [Figure 23](#).....17
-

PACKAGING INFORMATION

Orderable Device	Status ⁽¹⁾	Package Type	Package Drawing	Pins	Package Qty	Eco Plan ⁽²⁾	Lead/Ball Finish	MSL Peak Temp ⁽³⁾
TPS65171RHAR	ACTIVE	VQFN	RHA	40	2500	Green (RoHS & no Sb/Br)	CU NIPDAU	Level-3-260C-168 HR

⁽¹⁾ The marketing status values are defined as follows:

ACTIVE:Product device recommended for new designs.

LIFEBUY:TI has announced that the device will be discontinued, and a lifetime-buy period is in effect.

NRND:Not recommended for new designs. Device is in production to support existing customers, but TI does not recommend using this part in a new design.

PREVIEW:Device has been announced but is not in production. Samples may or may not be available.

OBsolete:TI has discontinued the production of the device.

⁽²⁾ Eco Plan - The planned eco-friendly classification: Pb-Free (RoHS), Pb-Free (RoHS Exempt), or Green (RoHS & no Sb/Br) - please check <http://www.ti.com/productcontent> for the latest availability information and additional product content details.

TBD:The Pb-Free/Green conversion plan has not been defined.

Pb-Free (RoHS):TI's terms "Lead-Free" or "Pb-Free" mean semiconductor products that are compatible with the current RoHS requirements for all 6 substances, including the requirement that lead not exceed 0.1% by weight in homogeneous materials. Where designed to be soldered at high temperatures, TI Pb-Free products are suitable for use in specified lead-free processes.

Pb-Free (RoHS Exempt):This component has a RoHS exemption for either 1) lead-based flip-chip solder bumps used between the die and package, or 2) lead-based die adhesive used between the die and leadframe. The component is otherwise considered Pb-Free (RoHS compatible) as defined above.

Green (RoHS & no Sb/Br):TI defines "Green" to mean Pb-Free (RoHS compatible), and free of Bromine (Br) and Antimony (Sb) based flame retardants (Br or Sb do not exceed 0.1% by weight in homogeneous material)

⁽³⁾ MSL, Peak Temp. -- The Moisture Sensitivity Level rating according to the JEDEC industry standard classifications, and peak solder temperature.

Important Information and Disclaimer:The information provided on this page represents TI's knowledge and belief as of the date that it is provided. TI bases its knowledge and belief on information provided by third parties, and makes no representation or warranty as to the accuracy of such information. Efforts are underway to better integrate information from third parties. TI has taken and continues to take reasonable steps to provide representative and accurate information but may not have conducted destructive testing or chemical analysis on incoming materials and chemicals. TI and TI suppliers consider certain information to be proprietary, and thus CAS numbers and other limited information may not be available for release.

In no event shall TI's liability arising out of such information exceed the total purchase price of the TI part(s) at issue in this document sold by TI to Customer on an annual basis.

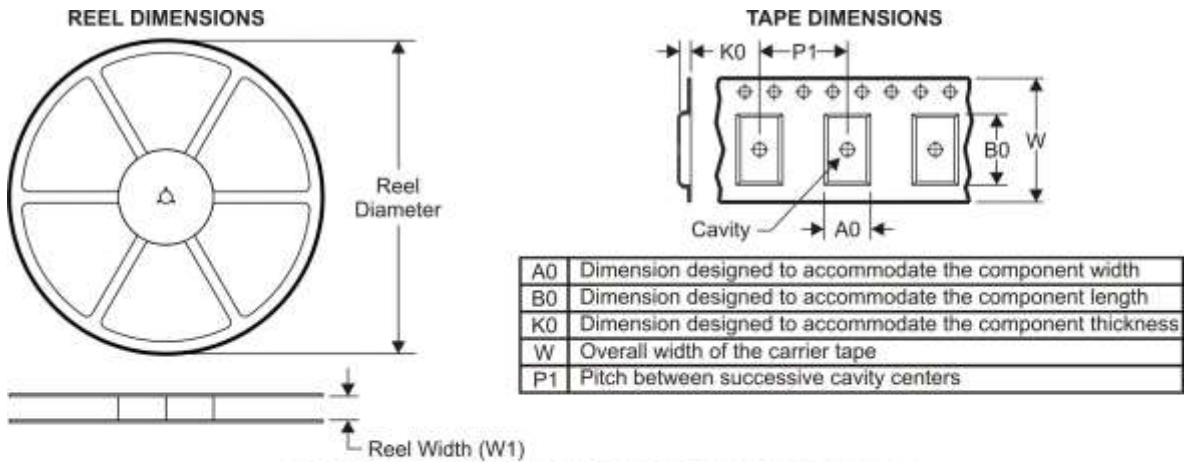
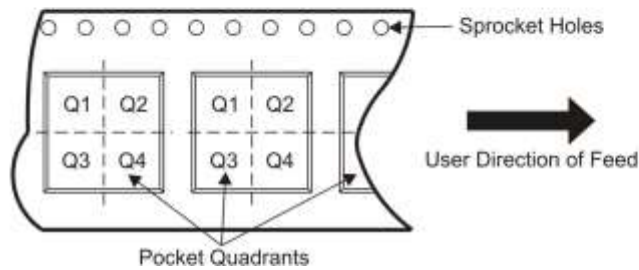
TAPE AND REEL INFORMATION

QUADRANT ASSIGNMENTS FOR PIN 1 ORIENTATION IN TAPE

*All dimensions are nominal

Device	Package Type	Package Drawing	Pins	SPQ	Reel Diameter (mm)	Reel Width W1 (mm)	A0 (mm)	B0 (mm)	K0 (mm)	P1 (mm)	W (mm)	Pin1 Quadrant
TPS65171RHAR	VQFN	RHA	40	2500	330.0	16.4	6.3	6.3	1.5	12.0	16.0	Q2

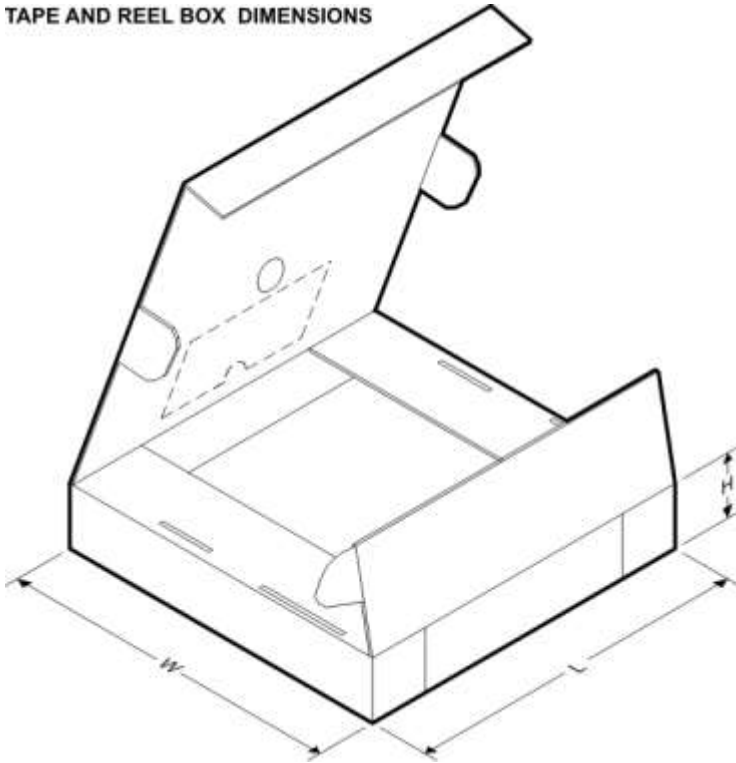
TAPE AND REEL BOX DIMENSIONS



*All dimensions are nominal

Device	Package Type	Package Drawing	Pins	SPQ	Length (mm)	Width (mm)	Height (mm)
TPS65171RHAR	VQFN	RHA	40	2500	346.0	346.0	33.0

RHA (S-PVQFN-N40)

PLASTIC QUAD FLATPACK NO-LEAD

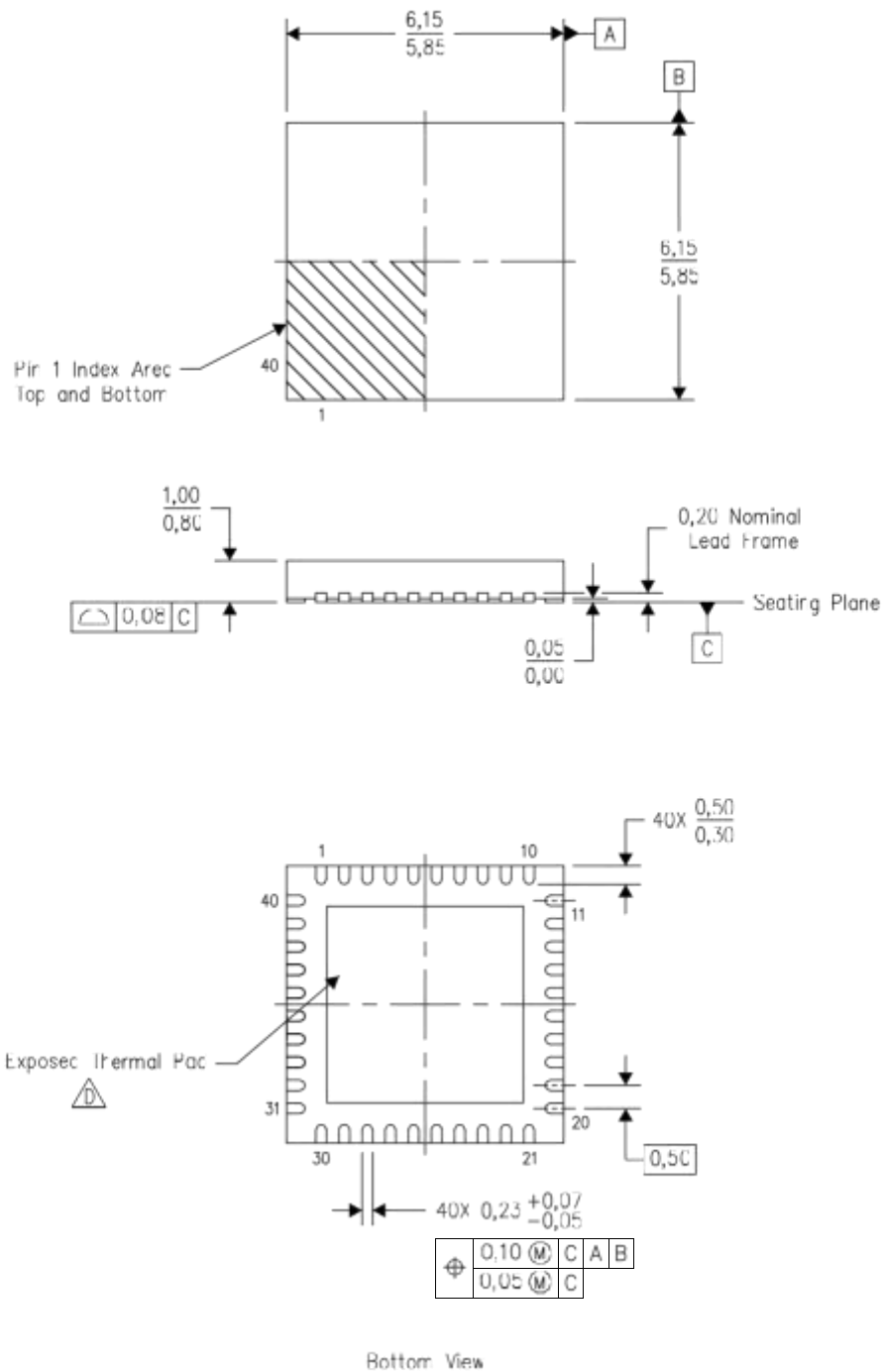

4204276/D 08/'0

- NOTES:
- A. All linear dimensions are in millimeters. Dimensioning and tolerancing per ASME Y14.5M-1994.
 - B. This drawing is subject to change without notice.
 - C. QFN (Quad Flatpack No-Lead) Package configuration.
 -  The package thermal pad must be soldered to the board for thermal and mechanical performance. See the Product Data Sheet for details regarding the exposed thermal pad dimensions.
 - F. Package complies to JEDEC MO-220 variation VJJD-2.

THERMAL INFORMATION

This package incorporates an exposed thermal pad that is designed to be attached directly to an external heatsink. The thermal pad must be soldered directly to the printed circuit board (PCB). After soldering, the PCB can be used as a heatsink. In addition, through the use of thermal vias, the thermal pad can be attached directly to the appropriate copper plane shown in the electrical schematic for the device, or alternatively, can be attached to a special heatsink structure designed into the PCB. This design optimizes the heat transfer from the integrated circuit (IC).

For information on the Quad Flatpack No-Lead (QFN) package and its advantages, refer to Application Report, QFN/SON PCB Attachment, Texas Instruments Literature No. SLUA271. This document is available at www.ti.com.

The exposed thermal pad dimensions for this package are shown in the following illustration.

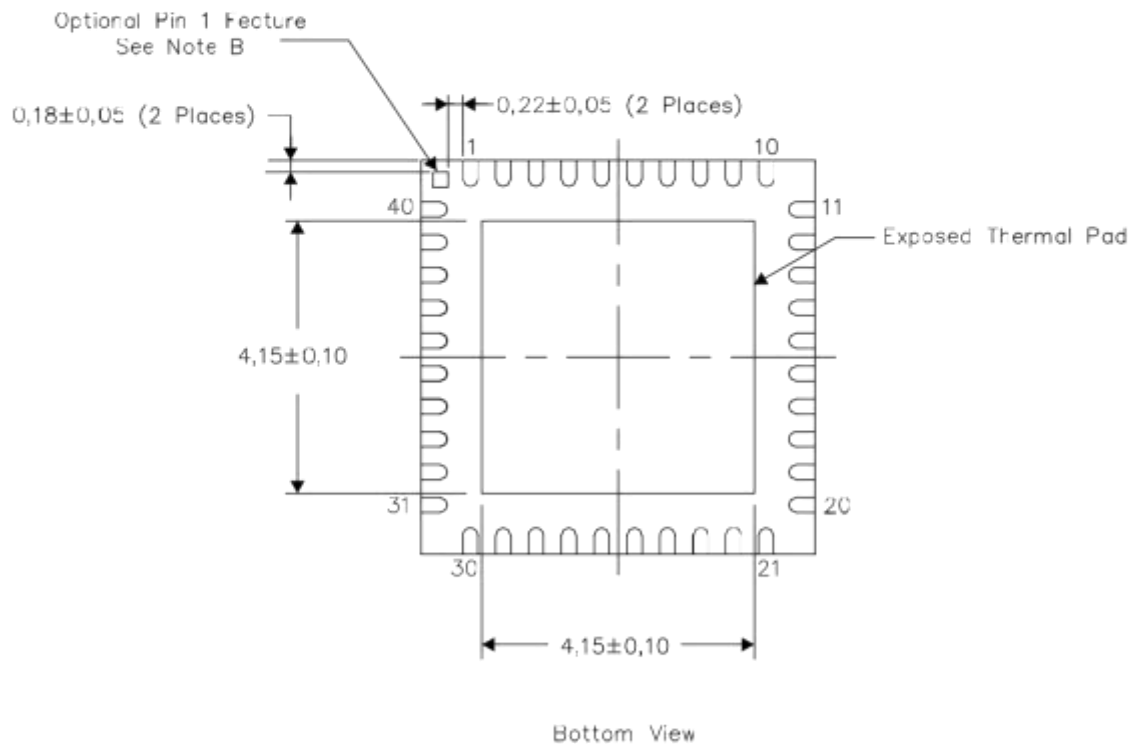

Exposed Thermal Pad Dimensions

4206355-2/N 03/1

- NOTES:
- A. All linear dimensions are in millimeters
 - B. The Pin 1 Identification mark is an optional feature that may be present on some devices. In addition, this Pin 1 feature if present is electrically connected to the center thermal pad and therefore should be considered when routing the board layout.

RHA (S-PVQFN-N40)

PLASTIC QUAD FLATPACK NO-LEAD

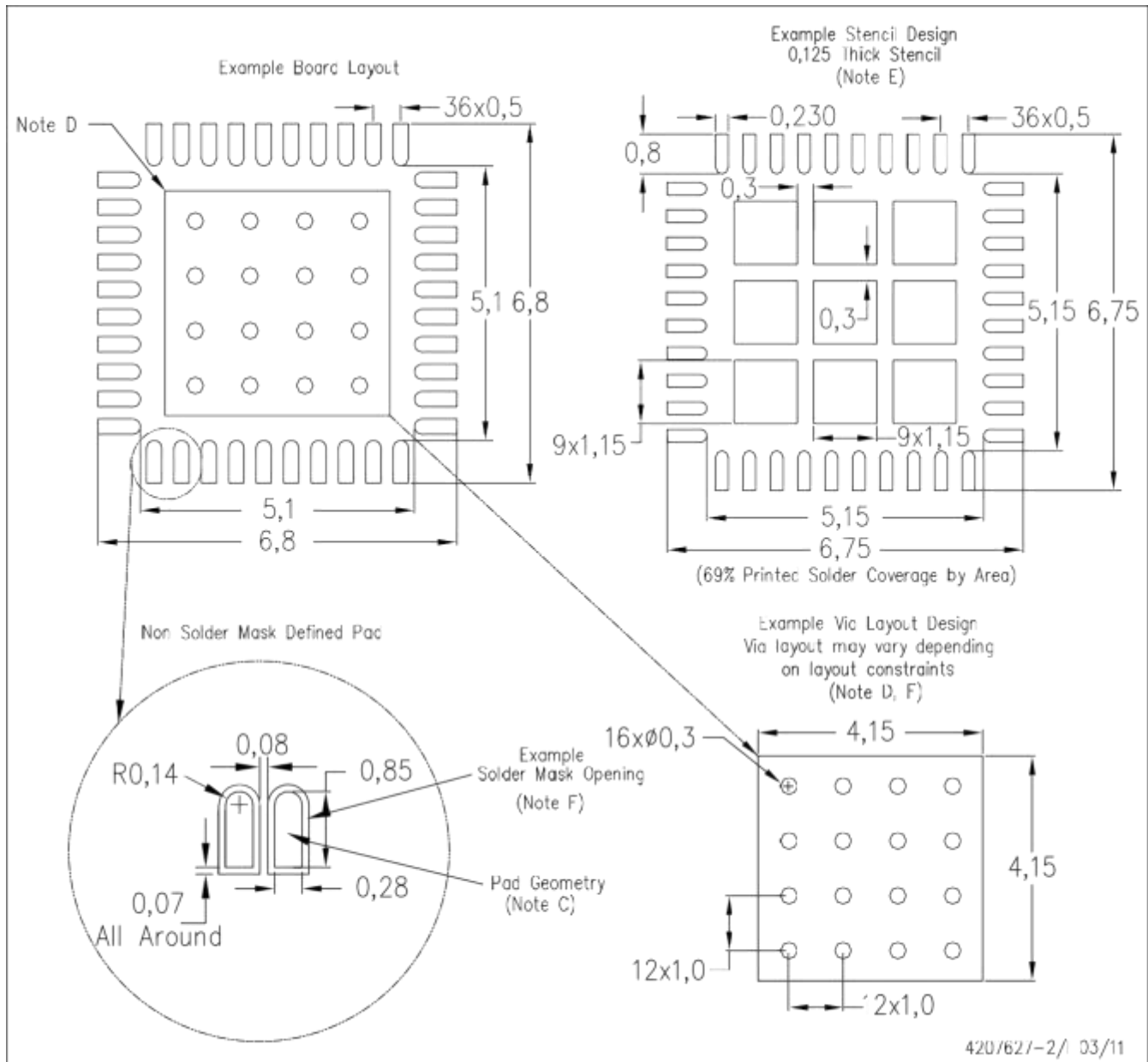

- NOTES:
- All linear dimensions are in millimeters.
 - This drawing is subject to change without notice.
 - Publication IPC-7351 is recommended for alternate designs.
 - This package is designed to be soldered to a thermal pad on the board. Refer to Application Note, Quad Flat-Pack Packages, Texas Instruments Literature No. SLUA271, and also the Product Data Sheets for specific thermal information, via requirements, and recommended board layout. These documents are available at www.ti.com.
 - Laser cutting apertures with trapezoidal walls and also rounding corners will offer better paste release. Customers should contact their board assembly site for stencil design recommendations. Refer to IPC 7525 for stencil design considerations.
 - Customers should contact their board fabrication site for recommended solder mask tolerances and via tenting recommendations for vias placed in the thermal pad.

IMPORTANT NOTICE

Texas Instruments Incorporated and its subsidiaries (TI) reserve the right to make corrections, modifications, enhancements, improvements, and other changes to its products and services at any time and to discontinue any product or service without notice. Customers should obtain the latest relevant information before placing orders and should verify that such information is current and complete. All products are sold subject to TI's terms and conditions of sale supplied at the time of order acknowledgment.

TI warrants performance of its hardware products to the specifications applicable at the time of sale in accordance with TI's standard warranty. Testing and other quality control techniques are used to the extent TI deems necessary to support this warranty. Except where mandated by government requirements, testing of all parameters of each product is not necessarily performed.

TI assumes no liability for applications assistance or customer product design. Customers are responsible for their products and applications using TI components. To minimize the risks associated with customer products and applications, customers should provide adequate design and operating safeguards.

TI does not warrant or represent that any license, either express or implied, is granted under any TI patent right, copyright, mask work right, or other TI intellectual property right relating to any combination, machine, or process in which TI products or services are used. Information published by TI regarding third-party products or services does not constitute a license from TI to use such products or services or a warranty or endorsement thereof. Use of such information may require a license from a third party under the patents or other intellectual property of the third party, or a license from TI under the patents or other intellectual property of TI.

Reproduction of TI information in TI data books or data sheets is permissible only if reproduction is without alteration and is accompanied by all associated warranties, conditions, limitations, and notices. Reproduction of this information with alteration is an unfair and deceptive business practice. TI is not responsible or liable for such altered documentation. Information of third parties may be subject to additional restrictions.

Resale of TI products or services with statements different from or beyond the parameters stated by TI for that product or service voids all express and any implied warranties for the associated TI product or service and is an unfair and deceptive business practice. TI is not responsible or liable for any such statements.

TI products are not authorized for use in safety-critical applications (such as life support) where a failure of the TI product would reasonably be expected to cause severe personal injury or death, unless officers of the parties have executed an agreement specifically governing such use. Buyers represent that they have all necessary expertise in the safety and regulatory ramifications of their applications, and acknowledge and agree that they are solely responsible for all legal, regulatory and safety-related requirements concerning their products and any use of TI products in such safety-critical applications, notwithstanding any applications-related information or support that may be provided by TI. Further, Buyers must fully indemnify TI and its representatives against any damages arising out of the use of TI products in such safety-critical applications.

TI products are neither designed nor intended for use in military/aerospace applications or environments unless the TI products are specifically designated by TI as military-grade or "enhanced plastic." Only products designated by TI as military-grade meet military specifications. Buyers acknowledge and agree that any such use of TI products which TI has not designated as military-grade is solely at the Buyer's risk, and that they are solely responsible for compliance with all legal and regulatory requirements in connection with such use.

TI products are neither designed nor intended for use in automotive applications or environments unless the specific TI products are designated by TI as compliant with ISO/TS 16949 requirements. Buyers acknowledge and agree that, if they use any non-designated products in automotive applications, TI will not be responsible for any failure to meet such requirements.

Following are URLs where you can obtain information on other Texas Instruments products and application solutions:

Products

Audio	www.ti.com/audio
Amplifiers	amplifier.ti.com
Data Converters	dataconverter.ti.com
DLP® Products	www.dlp.com
DSP	dsp.ti.com
Clocks and Timers	www.ti.com/clocks
Interface	interface.ti.com
Logic	logic.ti.com
Power Mgmt	power.ti.com
Microcontrollers	microcontroller.ti.com
RFID	www.ti-rfid.com
RF/IF and ZigBee® Solutions	www.ti.com/lprf

Applications

Communications and Telecom	www.ti.com/communications
Computers and Peripherals	www.ti.com/computers
Consumer Electronics	www.ti.com/consumer-apps
Energy and Lighting	www.ti.com/energy
Industrial	www.ti.com/industrial
Medical	www.ti.com/medical
Security	www.ti.com/security
Space, Avionics and Defense	www.ti.com/space-avionics-defense
Transportation and Automotive	www.ti.com/automotive
Video and Imaging	www.ti.com/video
Wireless	www.ti.com/wireless-apps

TI E2E Community Home Page

e2e.ti.com

Mailing Address: Texas Instruments, Post Office Box 655303, Dallas, Texas 75265
Copyright © 2011, Texas Instruments Incorporated