

Nano-Power, CMOS Input, RRIO, Push-Pull Output Comparator

FEATURES

- Low supply current
400nA (TYP) at $V_s = 1.4V$
- Low input offset voltage: $V_{os(max)} = \pm 3mV$
- Rail-to-Rail Input and output
- SUPPLY RANGE: +1.4V to +5.5V
- SPECIFIED UP TO +125°C
- *Micro* SIZE PACKAGES: SOT353(SC70-5), SOT23-5

APPLICATIONS

- OVERVOLTAGE AND UNDERVOLTAGE DETECTION
- MULTIVIBRATORS
- OVERCURRENT DETECTION
- SYSTEM MONITORING
- BATTERY POWERED SYSTEM

DESCRIPTION

The RS8907 offers a wide supply range, low quiescent current 400nA (TYP), and rail-to-rail inputs. All of these features come in industry-standard and extremely small packages, making this device an excellent choice for low-voltage and low-power applications for portable electronics and industrial systems.

Featuring a push-pull output stage, the RS8907 allows for operation with absolute minimum power consumption when driving any capacitive or resistive load.

The devices are ideal for system monitoring, include tablets, portable medical, smart phones. The RS8907 is specified at the full temperature range of -40°C to +125°C under single power supplies of 1.4V to 5.5V.

PIN CONFIGURATIONS

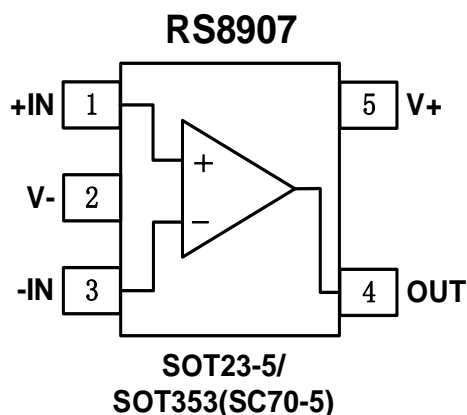

FUNCTION BLOCK DIAGRAM

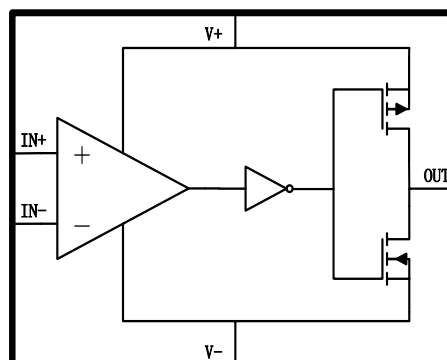

ABSOLUTE MAXIMUM RATINGS ⁽¹⁾

Supply Voltage, V+ to V-	7.0V
Input Terminals, Voltage ⁽²⁾	- 0.5 to (V+) + 0.5V
Current ⁽²⁾	±10mA
Storage Temperature	-65°C to +150°C
Operating Temperature	-40°C to +125°C
Junction Temperature	150°C
Lead Temperature (Soldering, 10s)	260°C
ESD Susceptibility	
HBM	3000V
MM	400V

(1) Stresses above these ratings may cause permanent damage. Exposure to absolute maximum conditions for extended periods may degrade device reliability. These are stress ratings only, and functional operation of the device at these or any other conditions beyond those specified is not implied.

(2) Input terminals are diode-clamped to the power-supply rails. Input signals that can swing more than 0.5V beyond the supply rails should be current-limited to 10mA or less.

ESD SENSITIVITY CAUTION

ESD damage can range from subtle performance degradation to complete device failure. Precision integrated circuits may be more susceptible to damage because very small parametric changes could cause the device not to meet its published specifications.

PACKAGE/ORDERING INFORMATION

PRODUCT	ORDERING NUMBER	TEMPERATURE RANGE	PACKAGE LEAD	PACKAGE MARKING	PACKAGE OPTION
RS8907	RS8907XF	-40°C ~ +125°C	SOT23-5	8907	Tape and Reel, 3000
	RS8907XC5	-40°C ~ +125°C	SOT353 (SC70-5)	8907	Tape and Reel, 3000

ELECTRICAL CHARACTERISTICS

 (At $T_A = +25^\circ\text{C}$, $V_S = 1.4\text{V}$ to 5.5V , $V_{CM} = V_S/2$, $C_L = 15\text{pF}$, unless otherwise noted.)

PARAMETER		CONDITIONS	RS8907			UNITS
			MIN	TYP	MAX	
POWER SUPPLY						
V_S	Operating Voltage Range		1.4		5.5	V
I_Q	Quiescent Current			400	1500	nA
PSRR	Power-Supply Rejection Ratio	$V_S = 1.4\text{V}$ to 5.5V , $V_{CM} = (V) + 0.5\text{V}$		70		dB
INPUT						
V_{OS}	Input Offset Voltage	$V_{CM} = V_S/2$, $V_S = 5.0\text{V}$		± 1	± 3	mV
$\Delta V_{OS}/\Delta T$	Input Offset Voltage Drift	$V_{CM} = V_S/2$, $-40^\circ\text{C} \leq T_A \leq 125^\circ\text{C}$		2		$\mu\text{V}/^\circ\text{C}$
I_B	Input Bias Current			1	10	pA
V_{CM}	Common-Mode Voltage Range	$T_A = -40^\circ\text{C}$ to 125°C	(V-)-0.1		(V+)+0.1	V
CMRR	Power-Supply Rejection Ratio	$V_S = 5.5\text{V}$, $V_{CM} = -0.1$ to 5.6V		70		dB
OUTPUT						
V_{OH}	Output Swing From Upper Rail	$V_S = 1.4\text{V}$, $I_O = 0.1\text{mA}$		70	75	mV
		$V_S = 5.0\text{V}$, $I_O = 2.5\text{mA}$		140	170	mV
V_{OL}	Output Swing From Lower Rail	$V_S = 1.4\text{V}$, $I_O = -0.1\text{mA}$		35	40	mV
		$V_S = 5.0\text{V}$, $I_O = -2.5\text{mA}$		85	115	mV
I_{SC}	Short Circuit Sink Current	$V_S = 5.0\text{V}$		42		mA
	Short Circuit Source Current	$V_S = 5.0\text{V}$		38		mA
SWITCHING						
T_{PHL}	Propagation Delay H To L	$V_S = 5.0\text{V}$, Overdrive = 10 mV		13		μs
		$V_S = 5.0\text{V}$, Overdrive = 100 mV		9		
		$V_S = 2.5\text{V}$, Overdrive = 10 mV		12		
		$V_S = 2.5\text{V}$, Overdrive = 100 mV		8		
		$V_S = 1.4\text{V}$, Overdrive = 10 mV		13		
		$V_S = 1.4\text{V}$, Overdrive = 100 mV		9		
T_{PLH}	Propagation Delay L To H	$V_S = 5.0\text{V}$, Overdrive = 10 mV		30		
		$V_S = 5.0\text{V}$, Overdrive = 100 mV		40		
		$V_S = 2.5\text{V}$, Overdrive = 10 mV		22		
		$V_S = 2.5\text{V}$, Overdrive = 100 mV		35		
		$V_S = 1.4\text{V}$, Overdrive = 10 mV		22		
		$V_S = 1.4\text{V}$, Overdrive = 100 mV		35		
T_R	Rise Time	Overdrive = 100 mV		240		ns
T_F	Fall Time	Overdrive = 100 mV		260		ns

TYPICAL CHARACTERISTICS

At $T_A = +25^\circ\text{C}$, $V_S=5\text{V}$, $V_{CM} = V_S/2$, $C_L=15\text{pF}$ unless otherwise noted.

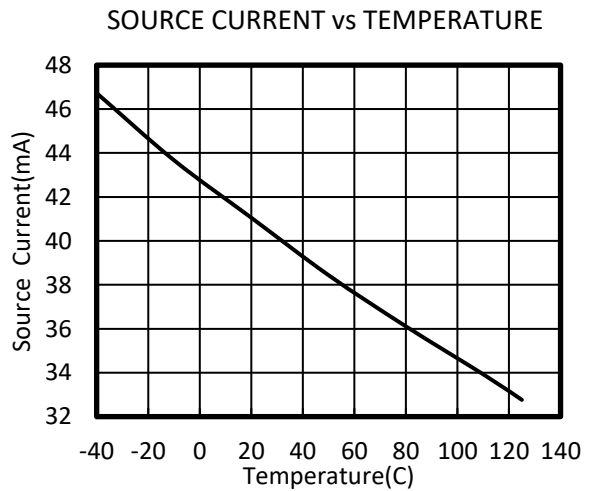
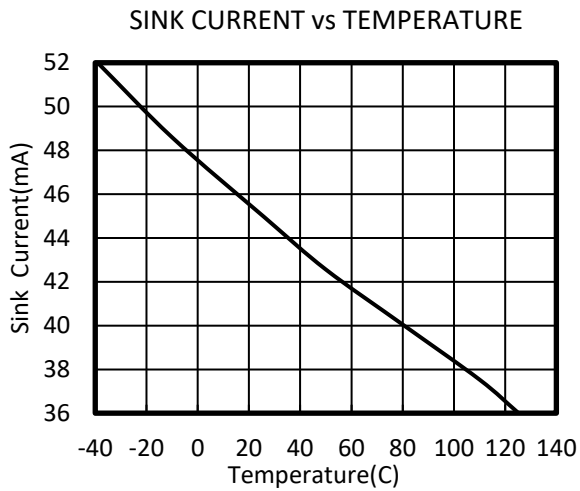
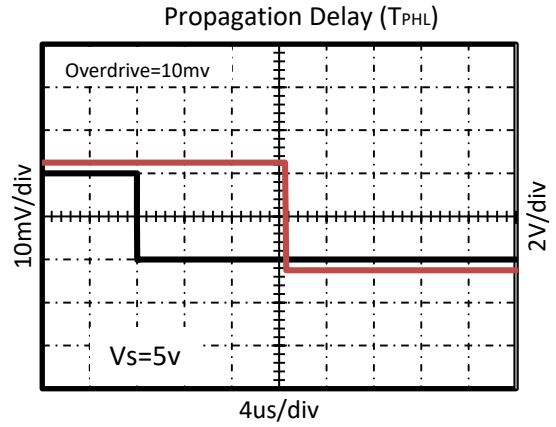
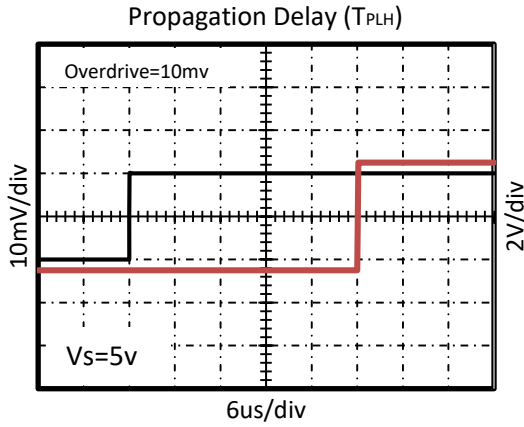

PACKAGE OUTLINE DIMENSIONS

SOT23-5

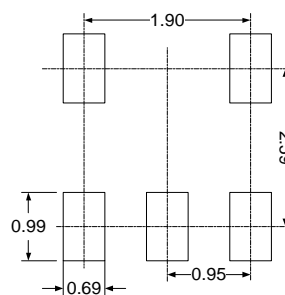
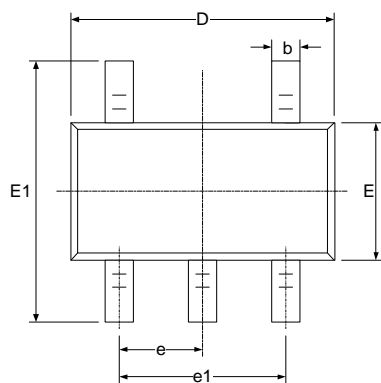

RECOMMENDED LAND PATTERN (Unit: mm)

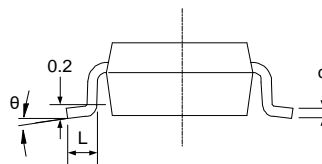
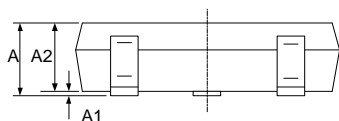

Symbol	Dimensions In Millimeters		Dimensions In Inches	
	Min	Max	Min	Max
A	1.050	1.250	0.041	0.049
A1	0.000	0.100	0.000	0.004
A2	1.050	1.150	0.041	0.045
b	0.300	0.500	0.012	0.020
c	0.100	0.200	0.004	0.008
D	2.820	3.020	0.111	0.119
E	1.500	1.700	0.059	0.067
E1	2.650	2.950	0.104	0.116
e	0.950(BSC)		0.037(BSC)	
e1	1.800	2.000	0.071	0.079
L	0.300	0.600	0.012	0.024
θ	0°	8°	0°	8°

SOT353(SC70-5)

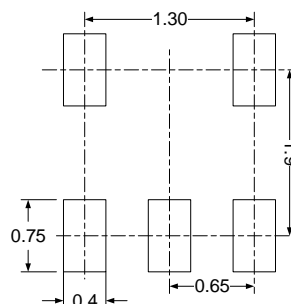
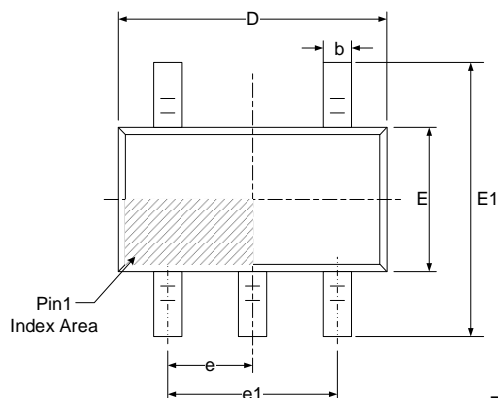

RECOMMENDED LAND PATTERN (Unit: mm)

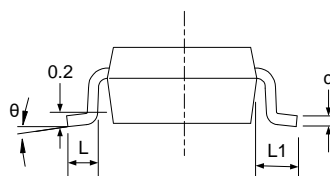
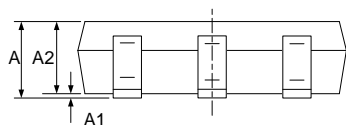

Symbol	Dimensions In Millimeters		Dimensions In Inches	
	Min	Max	Min	Max
A	0.900	1.100	0.035	0.043
A1	0.000	0.100	0.000	0.004
A2	0.900	1.000	0.035	0.039
b	0.150	0.350	0.006	0.014
c	0.080	0.150	0.003	0.006
D	2.000	2.200	0.079	0.087
E	1.150	1.350	0.045	0.053
E1	2.150	2.450	0.085	0.096
e	0.650(BSC)		0.026(BSC)	
e1	1.300(BSC)		0.051(BSC)	
L	0.260	0.460	0.010	0.018
L1	0.525		0.021	
θ	0°	8°	0°	8°