

# TLV9051 / TLV9052 / TLV9054 5-MHz, 15-V/ $\mu$ s High Slew-Rate, RRIO Op Amp

## 1 Features

- High slew rate: 15 V/ $\mu$ s
- Low quiescent current: 330  $\mu$ A
- Rail-to-rail input and output
- Low input offset voltage:  $\pm 0.33$  mV
- Unity-gain bandwidth: 5 MHz
- Low broadband noise: 15 nV/ $\sqrt{\text{Hz}}$
- Low input bias current: 2 pA
- Unity-gain stable
- Internal RFI and EMI filter
- Scalable family of CMOS op amps for low-cost applications
- Operational at supply voltages as low as 1.8 V
- Extended temperature range:  $-40^{\circ}\text{C}$  to  $125^{\circ}\text{C}$

## 2 Applications

- HVAC: heating, ventilating, and air conditioning
- Photodiode amplifier
- Current shunt monitoring for DC motor control
- White goods (refrigerators, washing machines, and so forth)
- Sensor signal conditioning
- Active filters
- Low-side current sensing

## 3 Description

The TLV9051, TLV9052, and TLV9054 devices are single, dual, and quad operational amplifiers, respectively. The devices are designed for low voltage operation from 1.8 V to 6.0 V. The inputs and outputs can operate from rail to rail at a very high slew rate. These devices are an excellent choice for cost-constrained applications where low-voltage operation, high slew rate, and low quiescent current is needed. The capacitive-load drive of the TLV905x family is 150 pF, and the resistive open-loop output impedance makes stabilization easier with much higher capacitive loads.

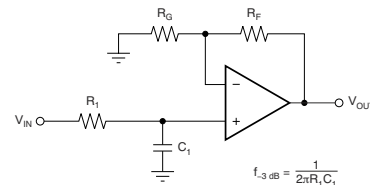
The TLV905xS devices include a shutdown mode that allow the amplifiers to be switched off into a standby mode with typical current consumption less than 1  $\mu$ A.

The TLV905x family is easy to use due to the devices being unity-gain stable, including a RFI and EMI filter, and being free from phase reversal in an overdrive condition.

### Device Information<sup>(1)</sup>

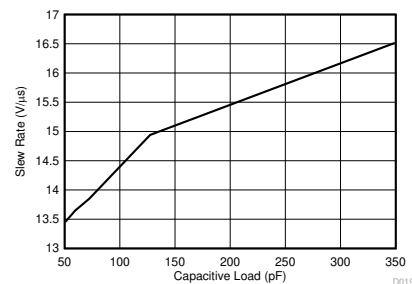
PART NUMBER	PACKAGE	BODY SIZE (NOM)
TLV9051	SOT-23 (5)	1.60 mm $\times$ 2.90 mm
	SC70 (5)	1.25 mm $\times$ 2.00 mm
	SOT553 (5) <sup>(2)</sup>	1.65 mm $\times$ 1.20 mm
	X2SON (5)	0.80 mm $\times$ 0.80 mm
TLV9051S	SOT-23 (6)	1.60 mm $\times$ 2.90 mm
TLV9052	SOIC (8)	3.91 mm $\times$ 4.90 mm
	TSSOP (8)	3.00 mm $\times$ 4.40 mm
	VSSOP (8)	3.00 mm $\times$ 3.00 mm
	SOT-23 (8)	1.60 mm $\times$ 2.90 mm
	WSON (8)	2.00 mm $\times$ 2.00 mm
TLV9052S	VSSOP (10)	3.00 mm $\times$ 3.00 mm
	X2QFN (10)	1.50 mm $\times$ 2.00 mm
TLV9054	SOIC (14)	8.65 mm $\times$ 3.91 mm
	TSSOP (14)	4.40 mm $\times$ 5.00 mm
	X2QFN (14)	2.00 mm $\times$ 2.00 mm
	WQFN (16)	3.00 mm $\times$ 3.00 mm
TLV9054S	WQFN (16)	3.00 mm $\times$ 3.00 mm

- (1) For all available packages, see the orderable addendum at the end of the data sheet.
- (2) Package is for preview only.



$$\frac{V_{OUT}}{V_{IN}} = \left(1 + \frac{R_2}{R_3}\right) \left(\frac{1}{1 + sR_1C_1}\right)$$

### Single-Pole, Low-Pass Filter



### Slew Rate vs Load Capacitance



## Table of Contents

<b>1 Features</b> .....	1	8.2 Functional Block Diagram.....	22
<b>2 Applications</b> .....	1	8.3 Feature Description.....	23
<b>3 Description</b> .....	1	8.4 Device Functional Modes.....	26
<b>4 Revision History</b> .....	2	<b>9 Application and Implementation</b> .....	27
<b>5 Device Comparison Table</b> .....	4	9.1 Application Information.....	27
<b>6 Pin Configuration and Functions</b> .....	5	9.2 Typical Low-Side Current Sense Application.....	27
<b>7 Specifications</b> .....	11	9.3 Power Supply Recommendations.....	29
7.1 Absolute Maximum Ratings.....	11	9.4 Layout.....	29
7.2 ESD Ratings.....	11	<b>10 Device and Documentation Support</b> .....	31
7.3 Recommended Operating Conditions.....	11	10.1 Documentation Support.....	31
7.4 Thermal Information for Single Channel.....	11	10.2 Related Links.....	31
7.5 Thermal Information for Dual Channel.....	12	10.3 Receiving Notification of Documentation Updates.....	31
7.6 Thermal Information for Quad Channel.....	12	10.4 Support Resources.....	31
7.7 Electrical Characteristics: $V_S$ (Total Supply Voltage) = (V+) – (V–) = 1.8 V to 5.5 V.....	13	10.5 Trademarks.....	31
7.8 Typical Characteristics.....	15	10.6 Electrostatic Discharge Caution.....	31
<b>8 Detailed Description</b> .....	22	10.7 Glossary.....	31
8.1 Overview.....	22	<b>11 Mechanical, Packaging, and Orderable Information</b> .....	32

## 4 Revision History

NOTE: Page numbers for previous revisions may differ from page numbers in the current version.

<b>Changes from Revision H (October 2019) to Revision I (November 2022)</b>	<b>Page</b>
• Changed maximum supply voltage in <i>Absolute Maximum Ratings</i> from 6 V to 7 V.....	11
• Added maximum limits for input bias current and input offset current.....	13
<b>Changes from Revision G (September 2019) to Revision H (October 2019)</b>	<b>Page</b>
• Added new human-body model and charged-device model ratings for TLV9051 X2SON package to the <i>ESD Ratings</i> .....	11
• Added <i>Packages With an Exposed Thermal Pad</i> section to <i>Feature Description</i> section.....	24
<b>Changes from Revision F (June 2019) to Revision G (September 2019)</b>	<b>Page</b>
• Deleted preview tags for all TLV9051 packages.....	1
• Deleted preview tags for the TLV9052 SOT-23 (8) - DDF package.....	1
• Added link to <i>Shutdown Function</i> section in all of the SHDN pin function rows.....	5
• Added <i>EMI Rejection</i> section to <i>Feature Description</i> section.....	23
• Added clarification to the <i>Shutdown Function</i> section.....	25
<b>Changes from Revision E (May 2019) to Revision F (June 2019)</b>	<b>Page</b>
• Deleted package preview notation for TLV9052S devices in <i>Device Information</i> .....	1
• Deleted package preview notation for TLV9052S devices under <i>Device Comparison Table</i> .....	4
• Deleted preview notation for TLV9052S devices in <i>Device Comparison Table</i> .....	4
• Deleted package preview notation for TLV9052S in <i>Pin Configuration and Functions</i> section.....	5
• Deleted package preview notation for TLV9052S under <i>Thermal Information for Dual Channel</i> .....	12
<b>Changes from Revision D (April 2019) to Revision E (May 2019)</b>	<b>Page</b>
• Added DDF (SOT-23) information to <i>Thermal Information for Dual Channel</i> table.....	12
<b>Changes from Revision C (April 2019) to Revision D (April 2019)</b>	<b>Page</b>
• Deleted preview notations for TLV9054/S devices in <i>Device Information</i> .....	1
• Deleted preview notations for TLV9054 devices in <i>Device Comparison Table</i> .....	4

• Deleted preview notations for TLV9054S device in <i>Device Comparison Table</i> .....	4
• Deleted preview notations for TLV9054 packages in <i>Pin Configurations and Functions</i> section.....	5
• Deleted preview notation for TLV9054S RTE package in <i>Pin Configurations and Functions</i> section.....	5
• Deleted preview notation for TLV9054/S packages in <i>Thermal Information for Quad Channel</i> .....	12

---

<b>Changes from Revision B (March 2019) to Revision C (April 2019)</b>	<b>Page</b>
--	-------------

• Added TLV9051 thermal information for DPW, DBV, and DCK packages.....	11
---	----

---

<b>Changes from Revision A (December 2018) to Revision B (March 2019)</b>	<b>Page</b>
---	-------------

• Added Shutdown device notes in the <i>Description</i> section.....	1
• Added SOT-23 (8) package to <i>Device Information</i> .....	1
• Added Shutdown devices to <i>Device Information</i> .....	1
• Added X2QFN (RUC) package to TLV9054 <i>Device Information</i> .....	1
• Added DDF package information to <i>Device Comparison Table</i> .....	4
• Added Shutdown devices (TLV9051S/TLV9052S/TLV9054S) and packages (DGS/RUG/RTE) to <i>Device Comparison Table</i> .....	4
• Added DDF (SOT-23) package.....	5
• Added TLV9051S pinout information to <i>Pin Configurations and Functions</i> section.....	5
• Added TLV9052S pinout information to <i>Pin Configurations and Functions</i> section.....	5
• Added TLV9054S and TLV9054 X2QFN (RUC) pinout information to <i>Pin Configurations and Functions</i> section.....	5
• Added TLV9051 and TLV9051S thermal information to <i>Thermal Information for Single Channel</i> .....	11
• Added TLV9052S thermal info to <i>Thermal Information for Dual Channel</i> .....	12
• Added DDF (SOT-23) package to <i>Thermal Information for Dual Channel</i> .....	12
• Added TLV9054 and TLV9054S thermal information to <i>Thermal Information for Quad Channel</i> .....	12
• Added Shutdown Function information in <i>Feature Description</i> section.....	25
• Added "S" suffix to <i>Related Links</i> to reflect the addition of Shutdown devices.....	31

---

<b>Changes from Revision * (August 2018) to Revision A (December 2018)</b>	<b>Page</b>
--	-------------

• Changed the device status from <i>Advance Information</i> to <i>Production Data</i> .....	1
---	---

## 5 Device Comparison Table

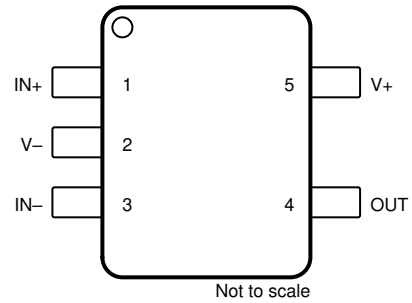
DEVICE	NO. OF CH.	PACKAGE LEADS												
		SC70 DCK	SOT-23 DBV	SOT-553 (1) DRL	X2SON DPW	SOIC D	WSON DSG	VSSOP DGK	TSSOP PW	SOT-23 DDF	VSSOP DGS	X2QFN RUG	X2QFN RUC	WQFN RTE
TLV9051	1	5	5	5	5	—	—	—	—	—	—	—	—	—
TLV9051S		—	6	—	—	—	—	—	—	—	—	—	—	—
TLV9052	2	—	—	—	—	8	8	8	8	8	—	—	—	—
TLV9052S		—	—	—	—	—	—	—	—	—	10	10	—	—
TLV9054	4	—	—	—	—	14	—	—	14	—	—	—	14	16
TLV9054S		—	—	—	—	—	—	—	—	—	—	—	—	16

(1) Package is for preview only.

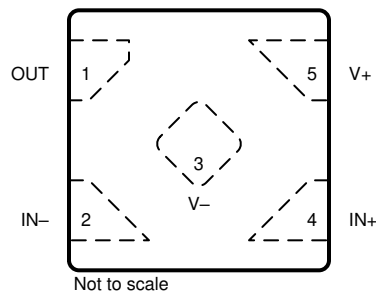
## 6 Pin Configuration and Functions



**Figure 6-1. TLV9051 DBV, DRL Packages 5-Pin SOT-23, SOT-553 Top View**



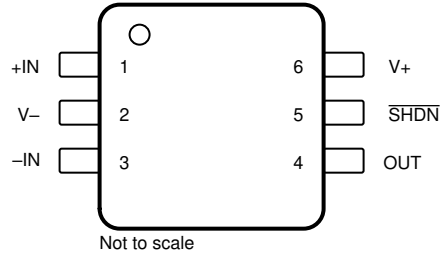
**Figure 6-2. TLV9051 DCK Package 5-Pin SC70 Top View**



**Figure 6-3. TLV9051 DPW Package 5-Pin X2SON Top View**

**Table 6-1. Pin Functions: TLV9051**

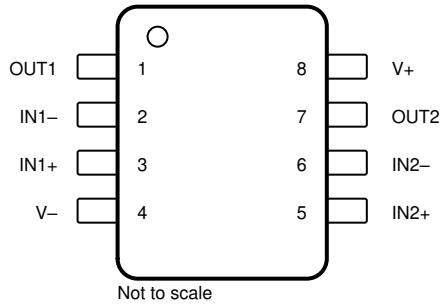
NAME	PIN			I/O	DESCRIPTION
	SOT-23, SOT-553	SC-70	X2SON		
IN-	4	3	2	I	Inverting input
IN+	3	1	4	I	Noninverting input
OUT	1	4	1	O	Output
V-	2	2	3	—	Negative (low) supply or ground (for single-supply operation)
V+	5	5	5	—	Positive (high) supply



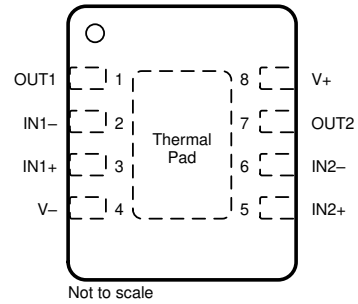
**Figure 6-4. TLV9051S DBV Package 6-Pin SOT-23 Top View**

**Table 6-2. Pin Functions: TLV9051S**

PIN		I/O	DESCRIPTION
NAME	NO.		
-IN	4	I	Inverting input
+IN	3	I	Noninverting input
OUT	1	O	Output
$\overline{\text{SHDN}}$	5	I	Shutdown: low = amp disabled, high = amp enabled. See <a href="#">Section 8.3.9</a> for more information.
V-	2	—	Negative (lowest) supply or ground (for single-supply operation).
V+	6	—	Positive (highest) supply



**Figure 6-5. TLV9052 D, DGK, PW, DDF Packages 8-Pin SOIC, VSSOP, TSSOP, SOT-23 Top View**



Connect exposed thermal pad to V-. See [Section 8.3.6](#) for more information.

**Figure 6-6. TLV9052 DSG Package 8-Pin WSON With Exposed Thermal Pad Top View**

**Table 6-3. Pin Functions: TLV9052**

PIN		I/O	DESCRIPTION
NAME	NO.		
IN1-	2	I	Inverting input, channel 1
IN1+	3	I	Noninverting input, channel 1
IN2-	6	I	Inverting input, channel 2
IN2+	5	I	Noninverting input, channel 2
OUT1	1	O	Output, channel 1
OUT2	7	O	Output, channel 2
V-	4	—	Negative (low) supply or ground (for single-supply operation)
V+	8	—	Positive (high) supply

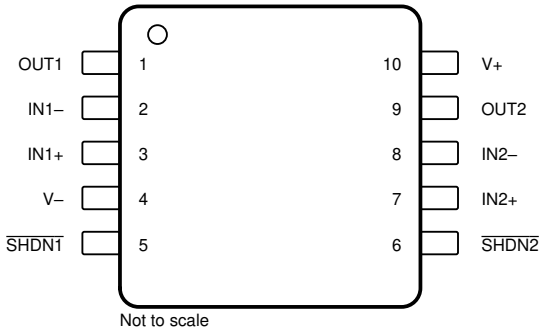


Figure 6-7. TLV9052S DGS Package 10-Pin VSSOP Top View

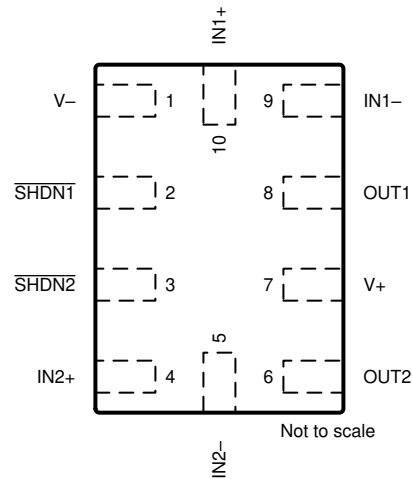
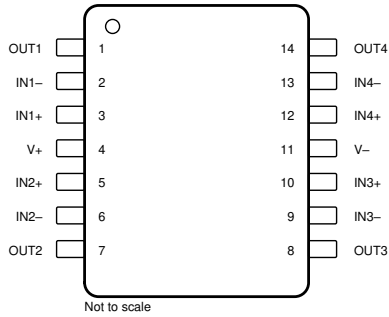


Figure 6-8. TLV9052S RUG Package 10-Pin X2QFN Top View

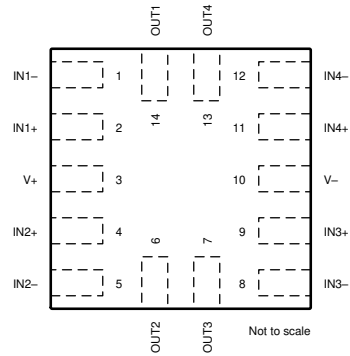
Table 6-4. Pin Functions: TLV9052S

NAME	PIN		I/O	DESCRIPTION
	VSSOP	X2QFN		
IN1-	2	9	I	Inverting input, channel 1
IN1+	3	10	I	Noninverting input, channel 1
IN2-	8	5	I	Inverting input, channel 2
IN2+	7	4	I	Noninverting input, channel 2
OUT1	1	8	O	Output, channel 1
OUT2	9	6	O	Output, channel 2
SHDN1	5	2	I	Shutdown: low = amp disabled, high = amp enabled, channel 1. See <a href="#">Section 8.3.9</a> for more information.
SHDN2	6	3	I	Shutdown: low = amp disabled, high = amp enabled, channel 2. See <a href="#">Section 8.3.9</a> for more information.
V-	4	1	—	Negative (low) supply or ground (for single-supply operation)
V+	10	7	—	Positive (high) supply

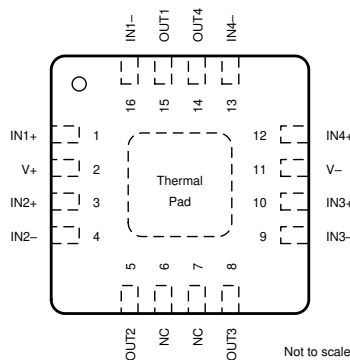




**Figure 6-9. TLV9054 D, PW Packages 14-Pin SOIC, TSSOP Top View**



**Figure 6-10. TLV9054 RUC Package 14-Pin X2QFN Top View**

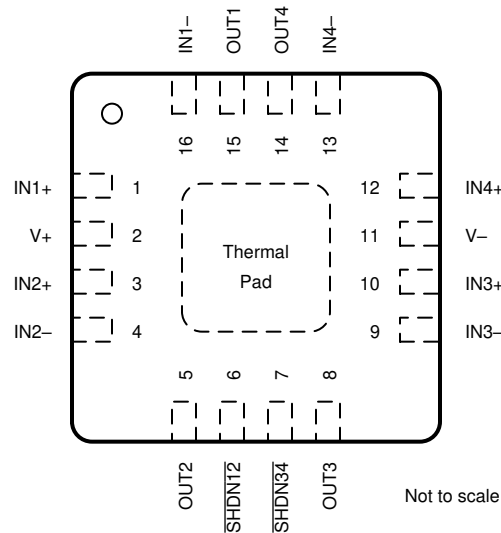


Connect exposed thermal pad to V-. See [Section 8.3.6](#) for more information.

**Figure 6-11. TLV9054 RTE Package 16-Pin WQFN With Exposed Thermal Pad Top View**

**Table 6-5. Pin Functions: TLV9054**

NAME	PIN			I/O	DESCRIPTION
	SOIC, TSSOP	WQFN	X2QFN		
IN1-	2	16	1	I	Inverting input, channel 1
IN1+	3	1	2	I	Noninverting input, channel 1
IN2-	6	4	5	I	Inverting input, channel 2
IN2+	5	3	4	I	Noninverting input, channel 2
IN3-	9	9	8	I	Inverting input, channel 3
IN3+	10	10	9	I	Noninverting input, channel 3
IN4-	13	13	12	I	Inverting input, channel 4
IN4+	12	12	11	I	Noninverting input, channel 4
NC	—	6, 7	—	—	No internal connection
OUT1	1	15	14	O	Output, channel 1
OUT2	7	5	6	O	Output, channel 2
OUT3	8	8	7	O	Output, channel 3
OUT4	14	14	13	O	Output, channel 4
V-	11	11	10	—	Negative (low) supply or ground (for single-supply operation)
V+	4	2	3	—	Positive (high) supply



Connect exposed thermal pad to V-. See [Section 8.3.6](#) for more information.

**Figure 6-12. TLV9054S RTE Package 16-Pin WQFN With Exposed Thermal Pad Top View**

**Table 6-6. Pin Functions: TLV9054S**

PIN		I/O	DESCRIPTION
NAME	NO.		
IN1+	1	I	Noninverting input, channel 1
IN1-	16	I	Inverting input, channel 1
IN2+	3	I	Noninverting input, channel 2
IN2-	4	I	Inverting input, channel 2
IN3+	10	I	Noninverting input, channel 3
IN3-	9	I	Inverting input, channel 3
IN4+	12	I	Noninverting input, channel 4
IN4-	13	I	Inverting input, channel 4
SHDN12	6	I	Shutdown: low = amp disabled, high = amp enabled, channel 1 and 2. See <a href="#">Section 8.3.9</a> for more information.
SHDN34	7	I	Shutdown: low = amp disabled, high = amp enabled, channel 3 and 4. See <a href="#">Section 8.3.9</a> for more information.
OUT1	15	O	Output, channel 1
OUT2	5	O	Output, channel 2
OUT3	8	O	Output, channel 3
OUT4	14	O	Output, channel 4
V-	11	—	Negative (low) supply or ground (for single-supply operation)
V+	2	—	Positive (high) supply

## 7 Specifications

### 7.1 Absolute Maximum Ratings

over operating free-air temperature (unless otherwise noted)<sup>(1)</sup>

			MIN	MAX	UNIT
Supply voltage				7	V
Signal input pins	Voltage <sup>(2)</sup>	Common-mode	(V-) – 0.5	(V+) + 0.5	V
		Differential		(V+) – (V-) + 0.2	
	Current <sup>(2)</sup>		–10	10	mA
Output short-circuit <sup>(3)</sup>			Continuous		mA
Temperature	Specified, T <sub>A</sub>		–40	125	°C
	Junction, T <sub>J</sub>			150	
	Storage, T <sub>stg</sub>		–65	150	

- (1) Stresses beyond those listed under *Absolute Maximum Ratings* may cause permanent damage to the device. These are stress ratings only, and functional operation of the device at these or any other conditions beyond those indicated under *Recommended Operating Conditions* is not implied. Exposure to absolute-maximum-rated conditions for extended periods may affect device reliability.
- (2) Input pins are diode-clamped to the power-supply rails. Current limit input signals that can swing more than 0.5 V beyond the supply rails to 10 mA or less.
- (3) Short-circuit to ground, one amplifier per package.

### 7.2 ESD Ratings

			VALUE	UNIT
<b>TLV9051 X2SON PACKAGE</b>				
V <sub>(ESD)</sub>	Electrostatic discharge	Human-body model (HBM), per ANSI/ESDA/JEDEC JS-001 <sup>(1)</sup>	±3000	V
		Charged-device model (CDM), per JEDEC specification JESD22-C101 <sup>(2)</sup>	±1500	
<b>ALL OTHER PACKAGES</b>				
V <sub>(ESD)</sub>	Electrostatic discharge	Human-body model (HBM), per ANSI/ESDA/JEDEC JS-001 <sup>(1)</sup>	±4000	V
		Charged-device model (CDM), per JEDEC specification JESD22-C101 <sup>(2)</sup>	±1500	

- (1) JEDEC document JEP155 states that 500-V HBM allows safe manufacturing with a standard ESD control process.
- (2) JEDEC document JEP157 states that 250-V CDM allows safe manufacturing with a standard ESD control process.

### 7.3 Recommended Operating Conditions

over operating junction temperature range (unless otherwise noted)

		MIN	MAX	UNIT
V <sub>S</sub>	Supply voltage, V <sub>S</sub> = (V+) – (V–)	1.8	6.0	V
V <sub>IN</sub>	Input pin voltage	(V–) – 0.1	(V+) + 0.1	V
	Specified temperature	–40	125	°C

### 7.4 Thermal Information for Single Channel

THERMAL METRIC <sup>(1)</sup>	TLV9051, TLV9051S					UNIT	
	DPW (X2SON)	DBV (SOT-23)		DCK (SC70)	DRL (SOT553) <sup>(2)</sup>		
	5 PINS	5 PINS	6 PINS	5 PINS	5 PINS		
R <sub>θJA</sub>	Junction-to-ambient thermal resistance	470.0	228.1	210.8	231.2	TBD	°C/W
R <sub>θJC(top)</sub>	Junction-to-case(top) thermal resistance	211.9	152.1	152.1	144.4	TBD	°C/W
R <sub>θJB</sub>	Junction-to-board thermal resistance	334.8	97.7	92.3	78.6	TBD	°C/W
Ψ <sub>JT</sub>	Junction-to-top characterization parameter	29.8	74.1	76.2	51.3	TBD	°C/W

THERMAL METRIC <sup>(1)</sup>		TLV9051, TLV9051S					UNIT
		DPW (X2SON)	DBV (SOT-23)		DCK (SC70)	DRL (SOT553) <sup>(2)</sup>	
		5 PINS	5 PINS	6 PINS	5 PINS	5 PINS	
$\Psi_{JB}$	Junction-to-board characterization parameter	333.2	97.3	92.1	78.3	TBD	°C/W
$R_{\theta JC(bot)}$	Junction-to-case(bottom) thermal resistance	N/A	N/A	N/A	N/A	TBD	°C/W

(1) For more information about traditional and new thermal metrics, see the [Semiconductor and IC Package Thermal Metrics](#) application report.

(2) This package option is for preview only.

### 7.5 Thermal Information for Dual Channel

THERMAL METRIC <sup>(1)</sup>		TLV9052, TLV9052S							UNIT
		D (SOIC)	DGK (VSSOP)	DSG (WSON)	PW (TSSOP)	DDF (SOT-23)	DGS (VSSOP)	RUG (X2QFN)	
		8 PINS	8 PINS	8 PINS	8 PINS	8 PINS	10 PINS	10 PINS	
$R_{\theta JA}$	Junction-to-ambient thermal resistance	155.4	208.8	102.3	205.1	184.4	170.4	197.2	°C/W
$R_{\theta JC(top)}$	Junction-to-case(top) thermal resistance	95.5	93.3	120.0	93.7	112.8	84.9	93.3	°C/W
$R_{\theta JB}$	Junction-to-board thermal resistance	98.9	130.7	68.2	135.7	99.9	113.5	123.8	°C/W
$\Psi_{JT}$	Junction-to-top characterization parameter	41.9	26.1	15.1	25.0	18.7	16.4	3.7	°C/W
$\Psi_{JB}$	Junction-to-board characterization parameter	98.1	128.9	68.2	134.0	99.3	112.3	120.2	°C/W
$R_{\theta JC(bot)}$	Junction-to-case(bottom) thermal resistance	N/A	N/A	43.6	N/A	N/A	N/A	N/A	°C/W

(1) For more information about traditional and new thermal metrics, see the [Semiconductor and IC Package Thermal Metrics](#) application report.

### 7.6 Thermal Information for Quad Channel

THERMAL METRIC <sup>(1)</sup>		TLV9054, TLV9054S					UNIT
		D (SOIC)	PW (TSSOP)	RTE (WQFN)		RUC (X2SQFN)	
		14 PINS	14 PINS	14 PINS	16 PINS	14 PINS	
$R_{\theta JA}$	Junction-to-ambient thermal resistance	115.0	147.2	65.5	65.6	209.4	°C/W
$R_{\theta JC(top)}$	Junction-to-case(top) thermal resistance	71.1	67.2	70.6	70.6	68.8	°C/W
$R_{\theta JB}$	Junction-to-board thermal resistance	71.0	91.6	40.5	40.5	153.3	°C/W
$\Psi_{JT}$	Junction-to-top characterization parameter	29.7	16.6	5.8	5.8	3.0	°C/W
$\Psi_{JB}$	Junction-to-board characterization parameter	70.6	90.7	40.5	40.5	152.8	°C/W
$R_{\theta JC(bot)}$	Junction-to-case(bottom) thermal resistance	N/A	N/A	24.5	24.5	N/A	°C/W

(1) For more information about traditional and new thermal metrics, see the [Semiconductor and IC Package Thermal Metrics](#) application report.

## 7.7 Electrical Characteristics: $V_S$ (Total Supply Voltage) = $(V_+) - (V_-) = 1.8\text{ V to }5.5\text{ V}$

at  $T_A = 25^\circ\text{C}$ ,  $R_L = 10\text{ k}\Omega$  connected to  $V_S / 2$ ,  $V_{CM} = V_S / 2$ , and  $V_{OUT} = V_S / 2$  (unless otherwise noted);

PARAMETER		TEST CONDITIONS	MIN	TYP	MAX	UNIT
<b>OFFSET VOLTAGE</b>						
$V_{OS}$	Input offset voltage	$V_S = 5\text{ V}$		$\pm 0.33$	$\pm 1.6$	mV
		$V_S = 5\text{ V}$ , $T_A = -40^\circ\text{C to }+125^\circ\text{C}$			$\pm 2$	
$dV_{OS}/dT$	Drift	$V_S = 5\text{ V}$ , $T_A = -40^\circ\text{C to }+125^\circ\text{C}$		$\pm 0.5$		$\mu\text{V}/^\circ\text{C}$
PSRR	Power-supply rejection ratio	$V_S = 1.8\text{ V} - 5.5\text{ V}$ , $V_{CM} = (V_-)$		$\pm 13$	$\pm 80$	$\mu\text{V}/\text{V}$
	Channel separation, dc	At dc		115		dB
<b>INPUT VOLTAGE RANGE</b>						
$V_{CM}$	Common-mode voltage	$V_S = 1.8\text{ V to }5.5\text{ V}$	$(V_-) - 0.1$		$(V_+) + 0.1$	V
CMRR	Common-mode rejection ratio	$V_S = 5.5\text{ V}$ , $(V_-) - 0.1\text{ V} < V_{CM} < (V_+) - 1.4\text{ V}$ , $T_A = -40^\circ\text{C to }+125^\circ\text{C}$	80	96		dB
		$V_S = 5.5\text{ V}$ , $V_{CM} = -0.1\text{ V to }5.6\text{ V}$ , $T_A = -40^\circ\text{C to }+125^\circ\text{C}$	62	79		
		$V_S = 1.8\text{ V}$ , $(V_-) - 0.1\text{ V} < V_{CM} < (V_+) - 1.4\text{ V}$ , $T_A = -40^\circ\text{C to }+125^\circ\text{C}$		88		
		$V_S = 1.8\text{ V}$ , $V_{CM} = -0.1\text{ V to }1.9\text{ V}$ , $T_A = -40^\circ\text{C to }+125^\circ\text{C}$		72		
<b>INPUT BIAS CURRENT</b>						
$I_B$	Input bias current			$\pm 2$	$\pm 18^{(2)}$	pA
		$T_A = -40^\circ\text{C to }+125^\circ\text{C}$				$\pm 525^{(2)}$
$I_{OS}$	Input offset current			$\pm 1$	$\pm 15^{(2)}$	pA
		$T_A = -40^\circ\text{C to }+125^\circ\text{C}$				$\pm 440^{(2)}$
<b>NOISE</b>						
$E_n$	Input voltage noise (peak-to-peak)	$V_S = 5\text{ V}$ , $f = 0.1\text{ Hz to }10\text{ Hz}$		6		$\mu\text{V}_{PP}$
$e_n$	Input voltage noise density	$V_S = 5\text{ V}$ , $f = 10\text{ kHz}$		15		$\text{nV}/\sqrt{\text{Hz}}$
		$V_S = 5\text{ V}$ , $f = 1\text{ kHz}$		20		$\text{nV}/\sqrt{\text{Hz}}$
$i_n$	Input current noise density	$f = 1\text{ kHz}$		18		$\text{fA}/\sqrt{\text{Hz}}$
<b>INPUT CAPACITANCE</b>						
$C_{ID}$	Differential			2		pF
$C_{IC}$	Common-mode			4		pF
<b>OPEN-LOOP GAIN</b>						
$A_{OL}$	Open-loop voltage gain	$V_S = 1.8\text{ V}$ , $(V_-) + 0.04\text{ V} < V_O < (V_+) - 0.04\text{ V}$ , $R_L = 10\text{ k}\Omega$		106		dB
		$V_S = 5.5\text{ V}$ , $(V_-) + 0.05\text{ V} < V_O < (V_+) - 0.05\text{ V}$ , $R_L = 10\text{ k}\Omega$	104	128		
		$V_S = 1.8\text{ V}$ , $(V_-) + 0.06\text{ V} < V_O < (V_+) - 0.06\text{ V}$ , $R_L = 2\text{ k}\Omega$		108		
		$V_S = 5.5\text{ V}$ , $(V_-) + 0.15\text{ V} < V_O < (V_+) - 0.15\text{ V}$ , $R_L = 2\text{ k}\Omega$		130		
<b>FREQUENCY RESPONSE</b>						
GBP	Gain bandwidth product	$V_S = 5.5\text{ V}$ , $G = +1$		5		MHz
$\phi_m$	Phase margin	$V_S = 5.5\text{ V}$ , $G = +1$		60		Degrees
SR	Slew rate	$V_S = 5.5\text{ V}$ , $G = +1$ , $C_L = 130\text{ pF}$		15		$\text{V}/\mu\text{s}$
$t_s$	Settling time	To 0.1%, $V_S = 5.5\text{ V}$ , 2-V step, $G = +1$ , $C_L = 100\text{ pF}$		0.75		$\mu\text{s}$
		To 0.01%, $V_S = 5.5\text{ V}$ , 2-V step, $G = +1$ , $C_L = 100\text{ pF}$		1		
$t_{OR}$	Overload recovery time	$V_S = 5.5\text{ V}$ , $V_{IN} \times \text{gain} > V_S$		0.3		$\mu\text{s}$
THD + N	Total harmonic distortion + noise <sup>(1)</sup>	$V_S = 5.5\text{ V}$ , $V_{CM} = 2.5\text{ V}$ , $V_O = 1\text{ V}_{RMS}$ , $G = +1$ , $f = 1\text{ kHz}$		0.0006%		
<b>OUTPUT</b>						
$V_O$	Voltage output swing from supply rails	$V_S = 5.5\text{ V}$ , $R_L = 10\text{ k}\Omega$ ,			16	mV
		$V_S = 5.5\text{ V}$ , $R_L = 2\text{ k}\Omega$ ,			40	

**7.7 Electrical Characteristics:  $V_S$  (Total Supply Voltage) = (V+) – (V–) = 1.8 V to 5.5 V (continued)**

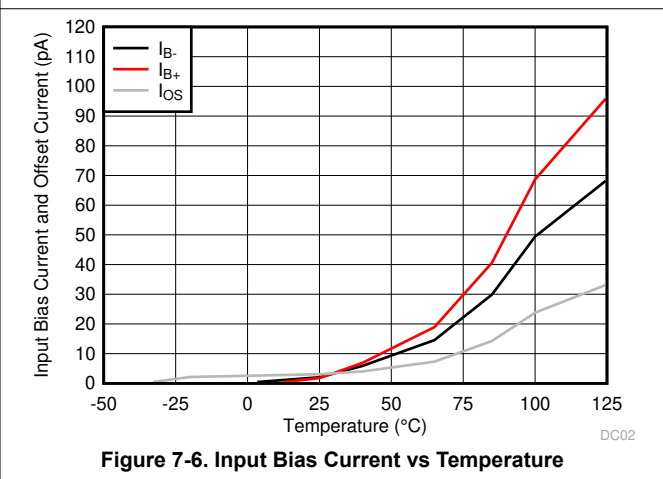
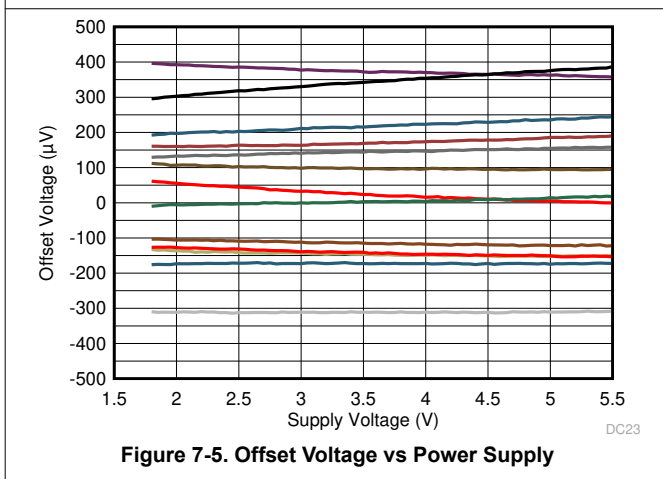
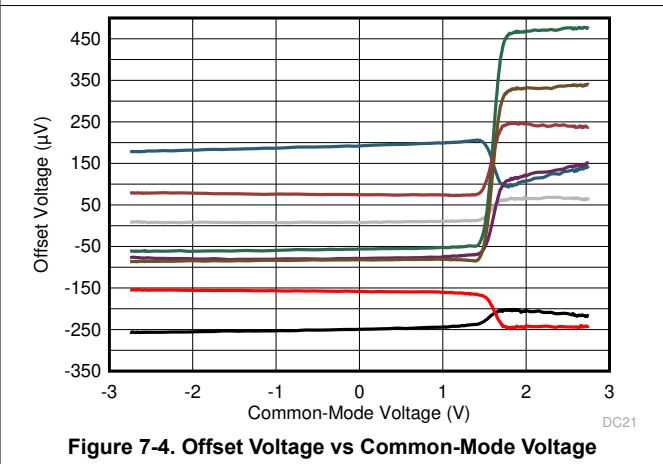
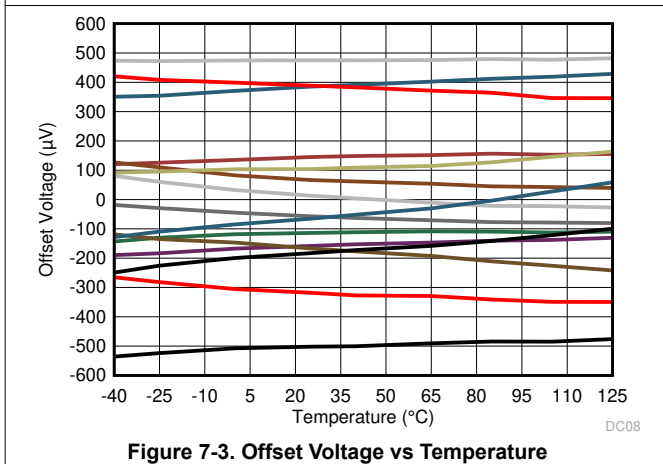
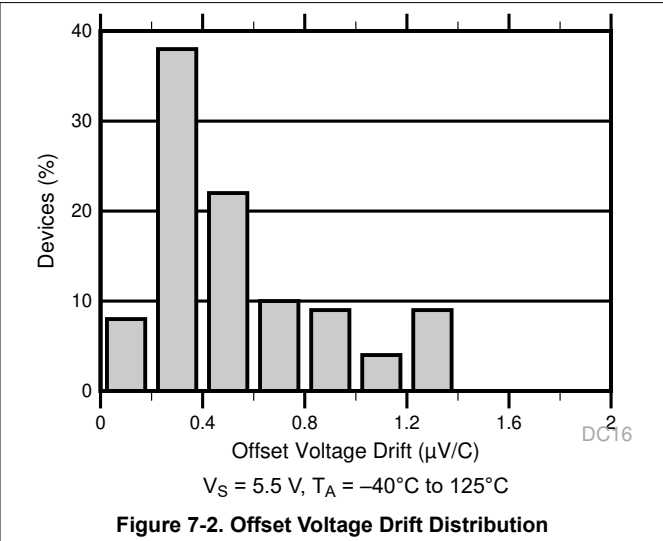
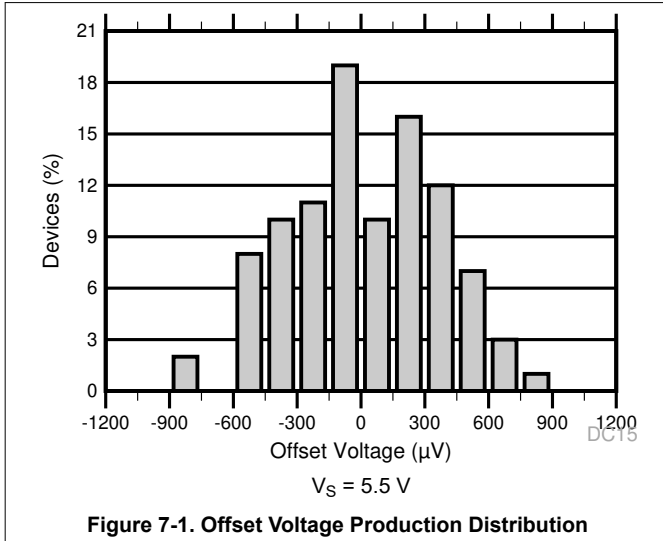
 at  $T_A = 25^\circ\text{C}$ ,  $R_L = 10\text{ k}\Omega$  connected to  $V_S / 2$ ,  $V_{CM} = V_S / 2$ , and  $V_{OUT} = V_S / 2$  (unless otherwise noted);

PARAMETER		TEST CONDITIONS	MIN	TYP	MAX	UNIT
$I_{SC}$	Short-circuit current	$V_S = 5\text{ V}$		$\pm 50$		mA
$Z_O$	Open-loop output impedance	$V_S = 5\text{ V}$ , $f = 5\text{ MHz}$		250		$\Omega$
<b>POWER SUPPLY</b>						
$I_Q$	Quiescent current per amplifier	$V_S = 5.5\text{ V}$ , $I_O = 0\text{ mA}$ ,		330	450	$\mu\text{A}$
		$V_S = 5.5\text{ V}$ , $I_O = 0\text{ mA}$ , $T_A = -40^\circ\text{C}$ to $+125^\circ\text{C}$			475	

- (1) Third-order filter; bandwidth = 80 kHz at –3 dB.
- (2) Specified by design and characterization; not production tested.

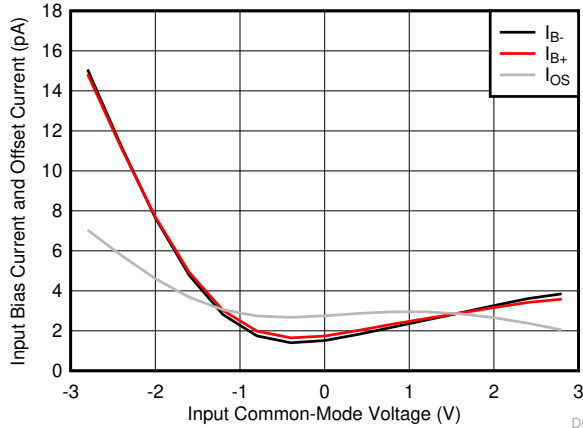
## 7.8 Typical Characteristics

at  $T_A = 25^\circ\text{C}$ ,  $V_S = 5.5\text{ V}$ ,  $R_L = 10\text{ k}\Omega$  connected to  $V_S / 2$ ,  $V_{CM} = V_S / 2$ , and  $V_{OUT} = V_S / 2$  (unless otherwise noted)

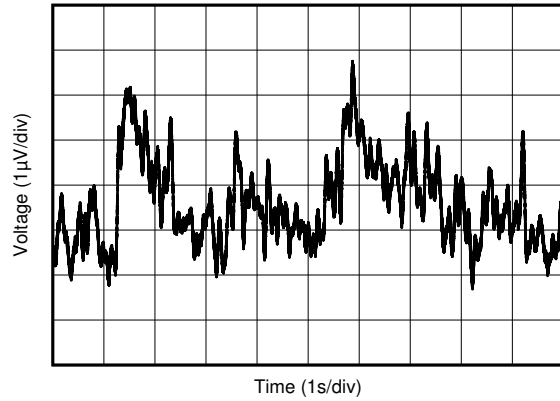


## 7.8 Typical Characteristics

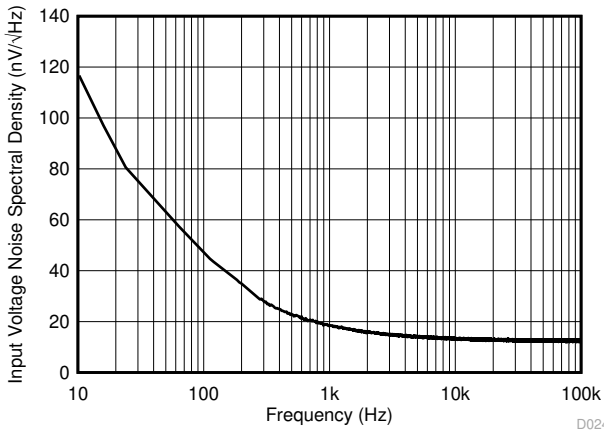
at  $T_A = 25^\circ\text{C}$ ,  $V_S = 5.5\text{ V}$ ,  $R_L = 10\text{ k}\Omega$  connected to  $V_S / 2$ ,  $V_{CM} = V_S / 2$ , and  $V_{OUT} = V_S / 2$  (unless otherwise noted)



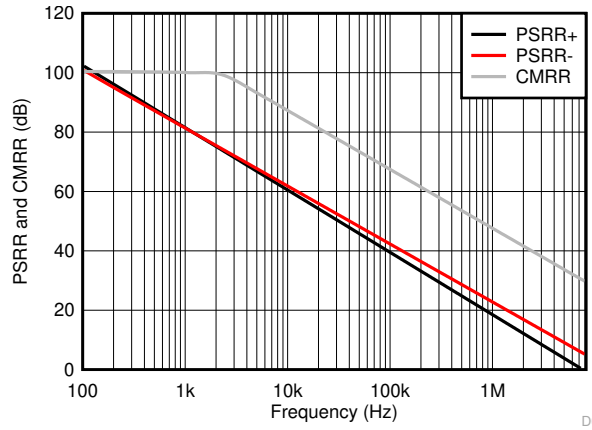
**Figure 7-7. Input Bias Current and Offset Current vs Common-Mode Voltage**



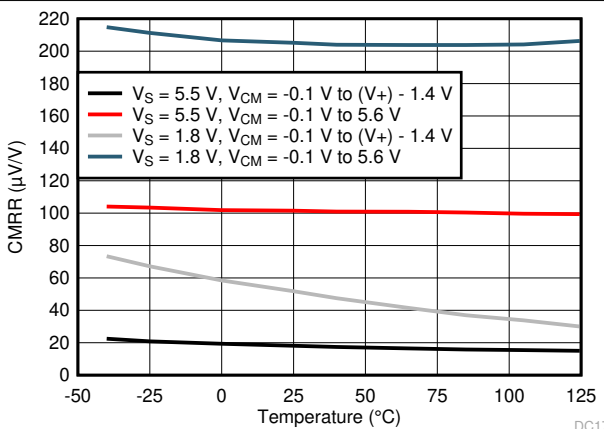
**Figure 7-8. 0.1-Hz to 10-Hz Input Voltage Noise**



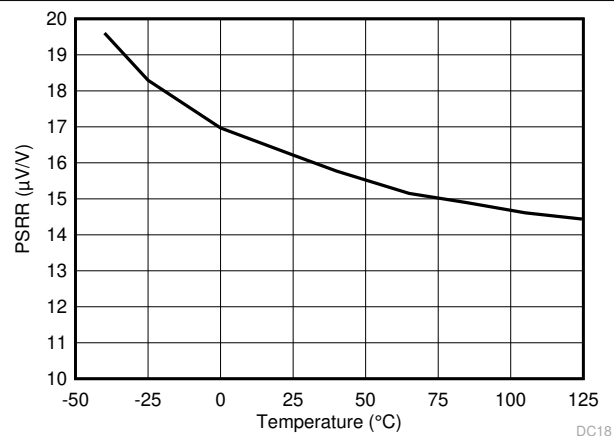
**Figure 7-9. Input Voltage Noise Spectral Density vs Frequency**



**Figure 7-10. CMRR and PSRR vs Frequency (Referred to Input)**



**Figure 7-11. CMRR vs Temperature**

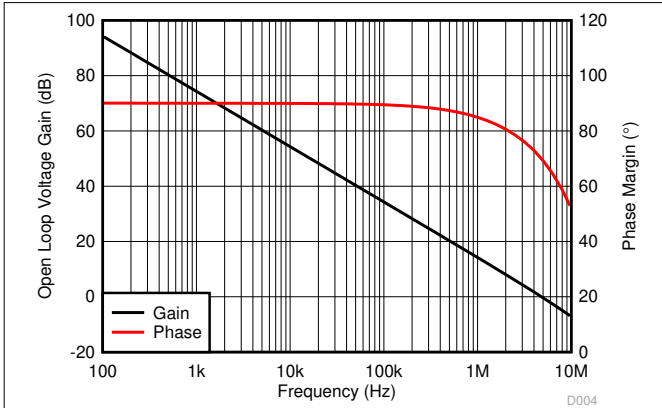


**Figure 7-12. PSRR vs Temperature**

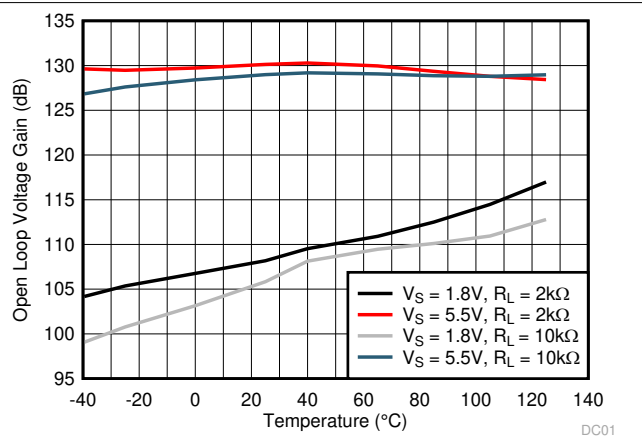


### 7.8 Typical Characteristics (continued)

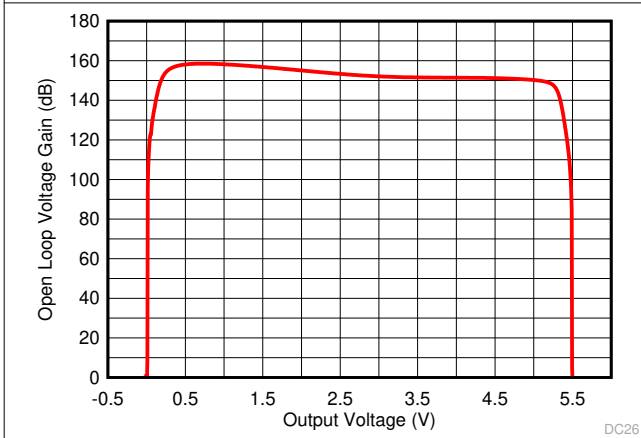
at  $T_A = 25^\circ\text{C}$ ,  $V_S = 5.5\text{ V}$ ,  $R_L = 10\text{ k}\Omega$  connected to  $V_S / 2$ ,  $V_{CM} = V_S / 2$ , and  $V_{OUT} = V_S / 2$  (unless otherwise noted)



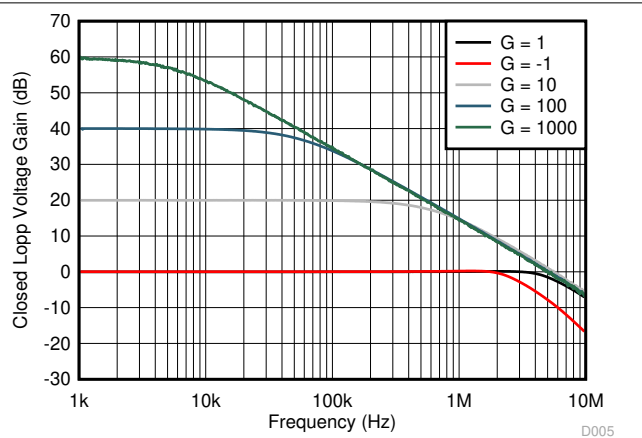
**Figure 7-13. Open Loop Voltage Gain and Phase vs Frequency**



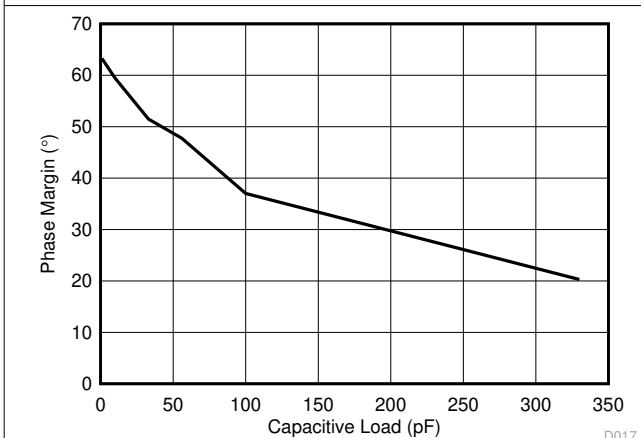
**Figure 7-14. Open Loop Voltage Gain vs Temperature**



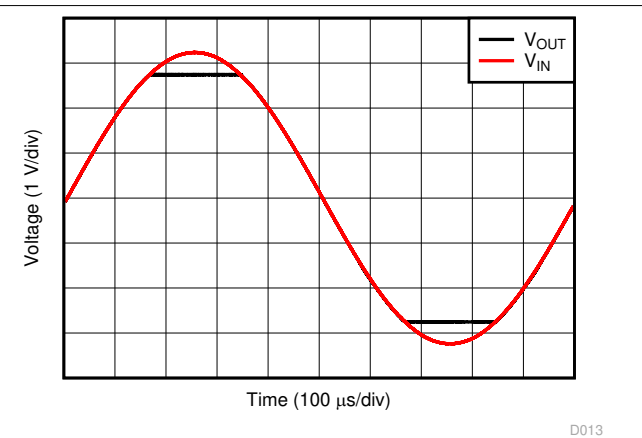
**Figure 7-15. Open Loop Voltage Gain vs Output Voltage**



**Figure 7-16. Closed Loop Voltage Gain vs Frequency**



**Figure 7-17. Phase Margin vs Capacitive Load**



**Figure 7-18. No Phase Reversal**

### 7.8 Typical Characteristics (continued)

at  $T_A = 25^\circ\text{C}$ ,  $V_S = 5.5\text{ V}$ ,  $R_L = 10\text{ k}\Omega$  connected to  $V_S / 2$ ,  $V_{CM} = V_S / 2$ , and  $V_{OUT} = V_S / 2$  (unless otherwise noted)

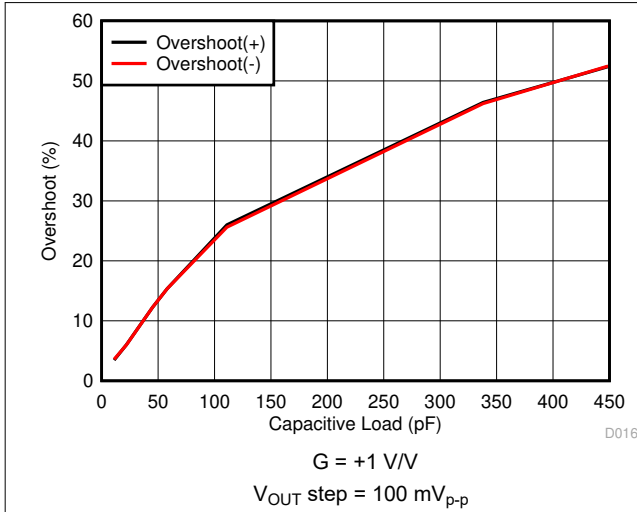


Figure 7-19. Small-Signal Overshoot vs Load Capacitance

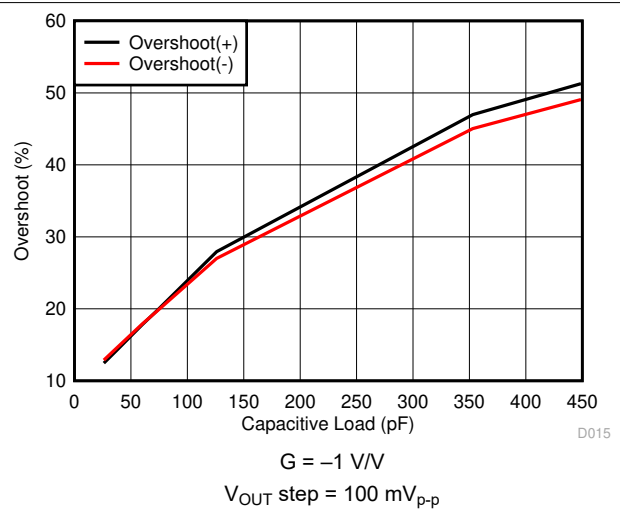


Figure 7-20. Small-Signal Overshoot vs Load Capacitance

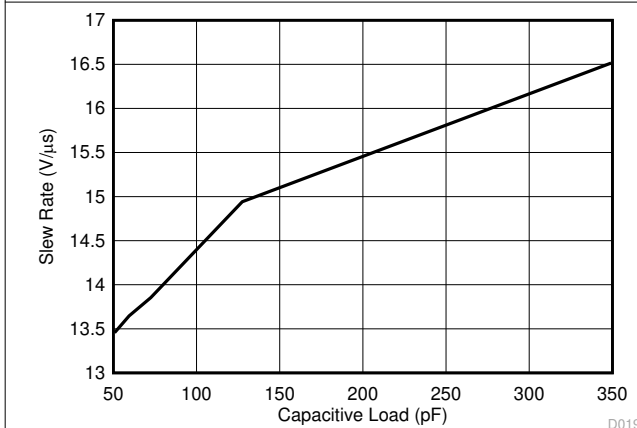


Figure 7-21. Slew Rate vs Capacitive Load

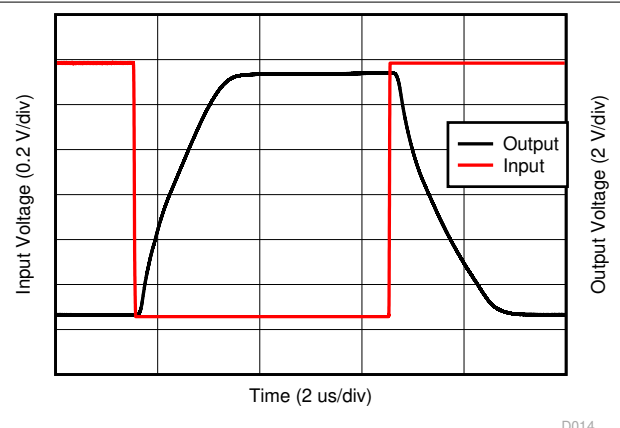


Figure 7-22. Overload Recovery

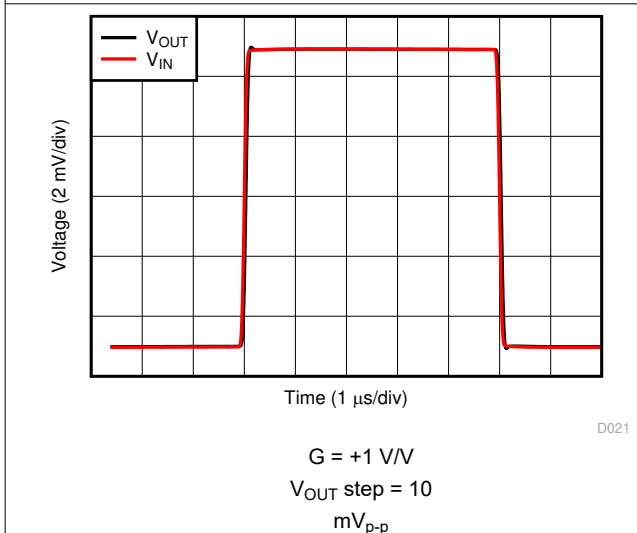


Figure 7-23. Small-Signal Step Response

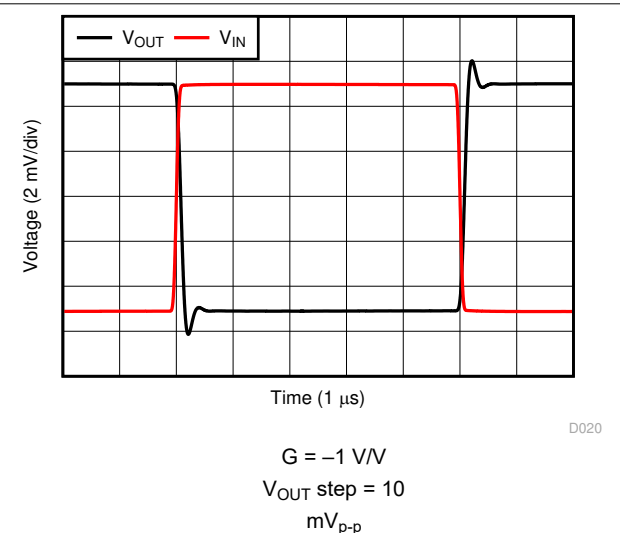
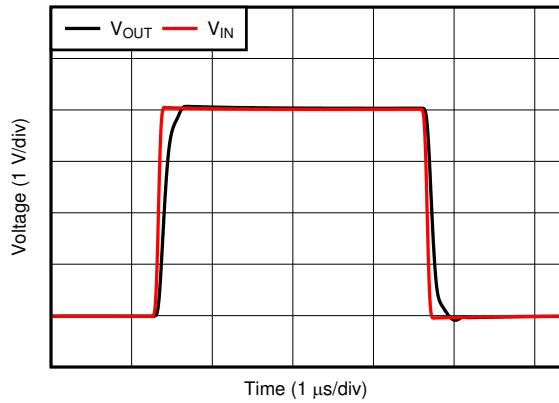


Figure 7-24. Small-Signal Step Response

## 7.8 Typical Characteristics (continued)

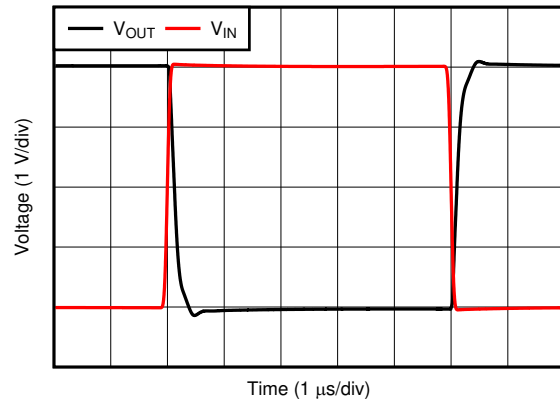
at  $T_A = 25^\circ\text{C}$ ,  $V_S = 5.5\text{ V}$ ,  $R_L = 10\text{ k}\Omega$  connected to  $V_S / 2$ ,  $V_{CM} = V_S / 2$ , and  $V_{OUT} = V_S / 2$  (unless otherwise noted)



$G = +1\text{ V/V}$   
 $V_{OUT}\text{ step} = 4\text{ V}_{p-p}$

D012

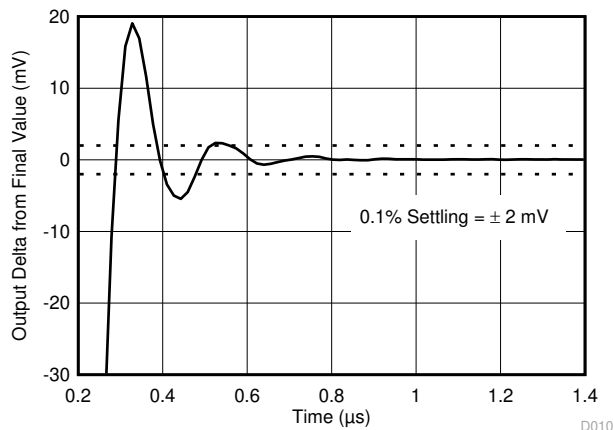
**Figure 7-25. Large-Signal Step Response**



$G = -1\text{ V/V}$   
 $V_{OUT}\text{ step} = 4\text{ V}_{p-p}$

D011

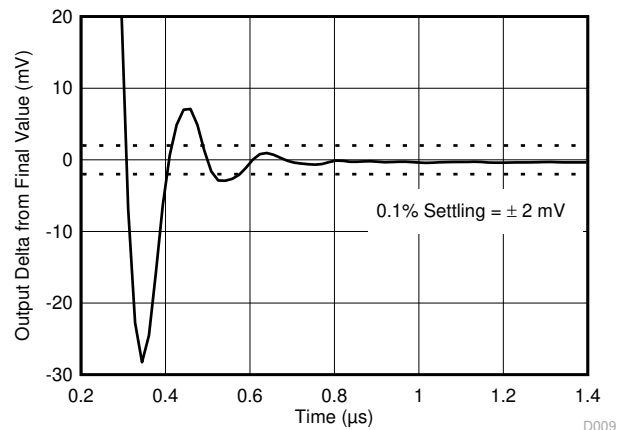
**Figure 7-26. Large-Signal Step Response**



$C_L = 100\text{ pF}$       $G = +1\text{ V/V}$

D010

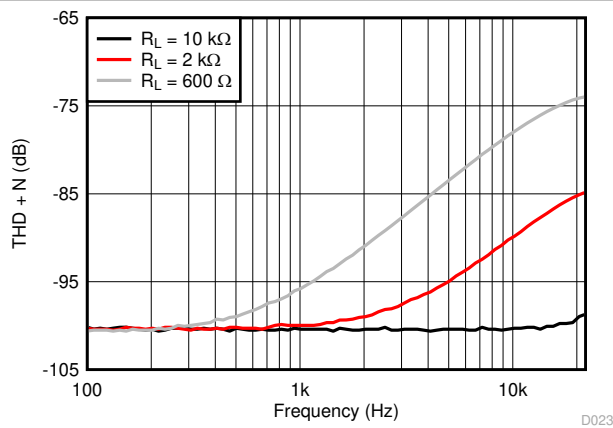
**Figure 7-27. Positive Large-Signal Settling Time**



$C_L = 100\text{ pF}$       $G = +1\text{ V/V}$

D009

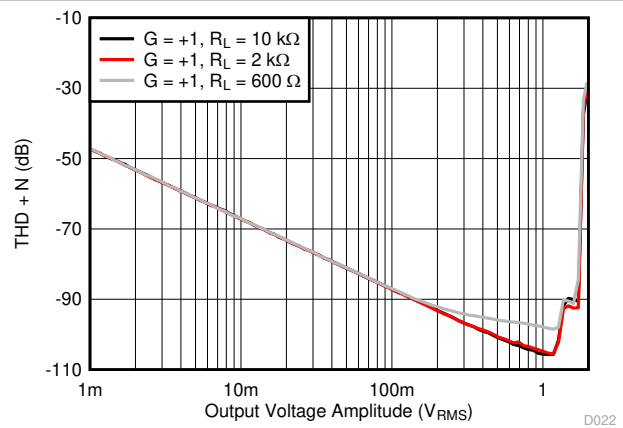
**Figure 7-28. Negative Large-Signal Settling Time**



$V_{OUT} = 0.5\text{ V}_{RMS}$       $G = +1$       $V_{CM} = 2.5\text{ V}$   
 $BW = 80\text{ kHz}$

D023

**Figure 7-29. THD + N vs Frequency**



$f = 1\text{ kHz}$       $G = +1$       $V_{CM} = 2.5\text{ V}$   
 $BW = 80\text{ kHz}$

D022

**Figure 7-30. THD + N vs Amplitude**

## 7.8 Typical Characteristics (continued)

at  $T_A = 25^\circ\text{C}$ ,  $V_S = 5.5\text{ V}$ ,  $R_L = 10\text{ k}\Omega$  connected to  $V_S / 2$ ,  $V_{CM} = V_S / 2$ , and  $V_{OUT} = V_S / 2$  (unless otherwise noted)

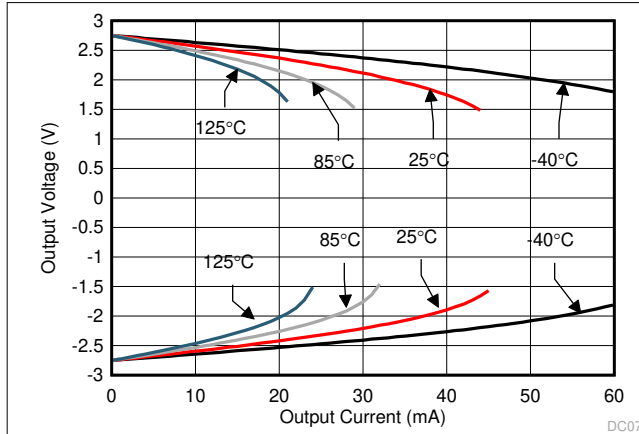


Figure 7-31. Output Voltage Swing vs Output Current

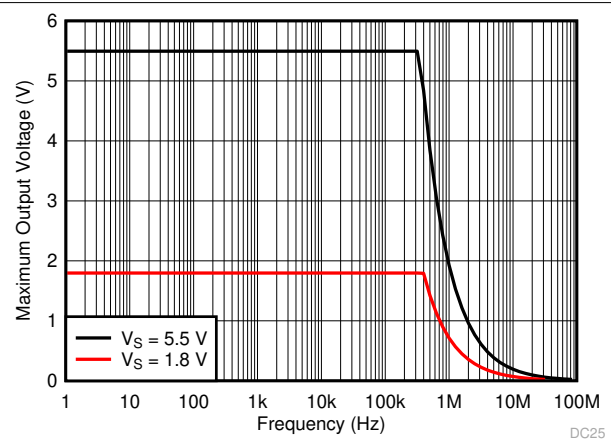


Figure 7-32. Maximum Output Voltage vs Frequency and Supply Voltage

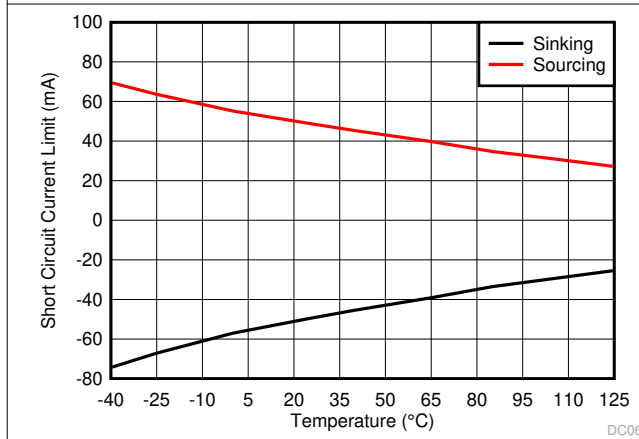


Figure 7-33. Short-Circuit Current vs Temperature

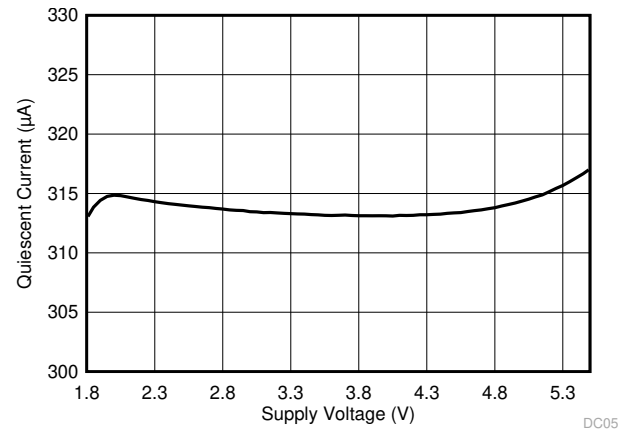


Figure 7-34. Quiescent Current vs Supply Voltage

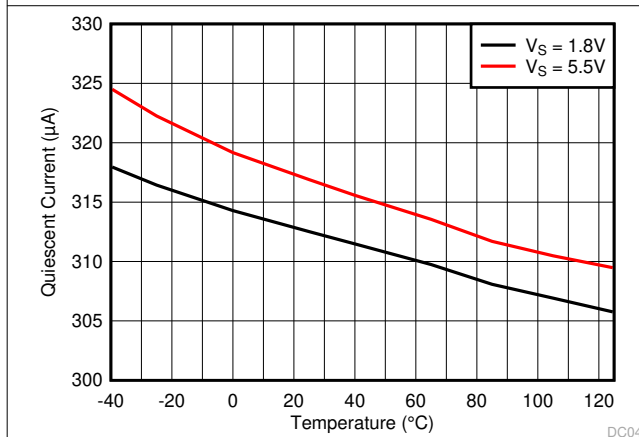


Figure 7-35. Quiescent Current vs Temperature

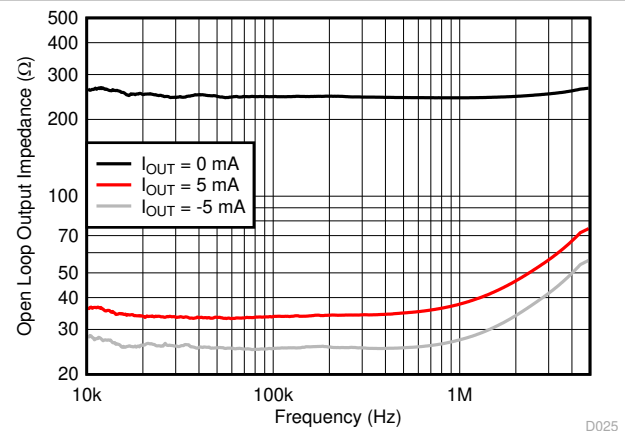
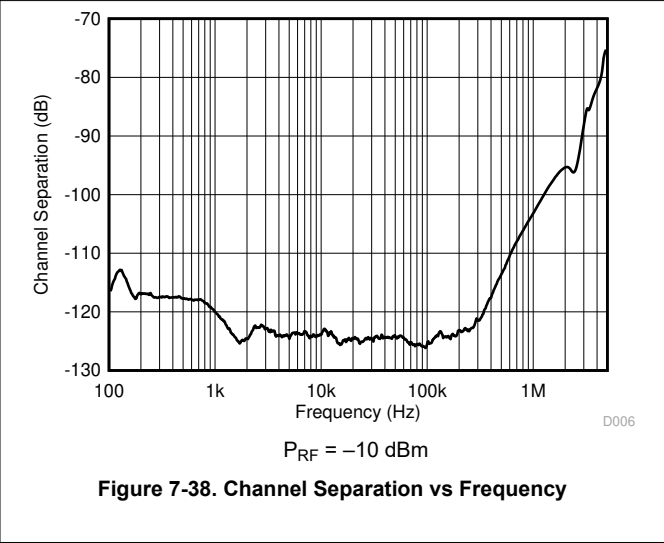
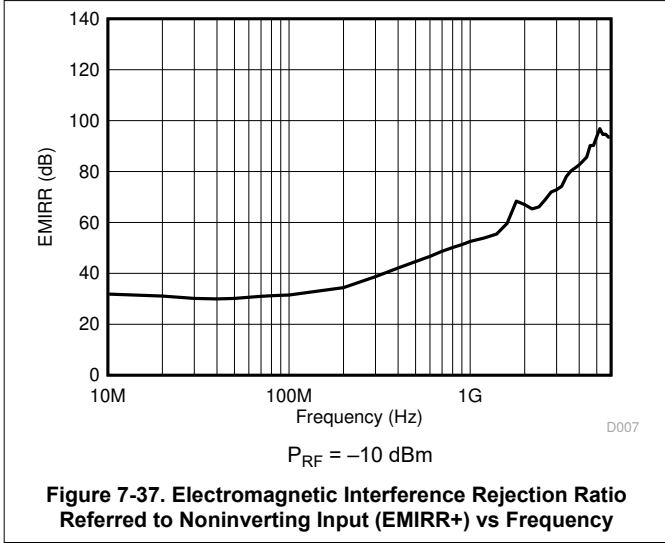


Figure 7-36. Open-Loop Output Impedance vs Frequency

### 7.8 Typical Characteristics (continued)

at  $T_A = 25^\circ\text{C}$ ,  $V_S = 5.5\text{ V}$ ,  $R_L = 10\text{ k}\Omega$  connected to  $V_S / 2$ ,  $V_{CM} = V_S / 2$ , and  $V_{OUT} = V_S / 2$  (unless otherwise noted)

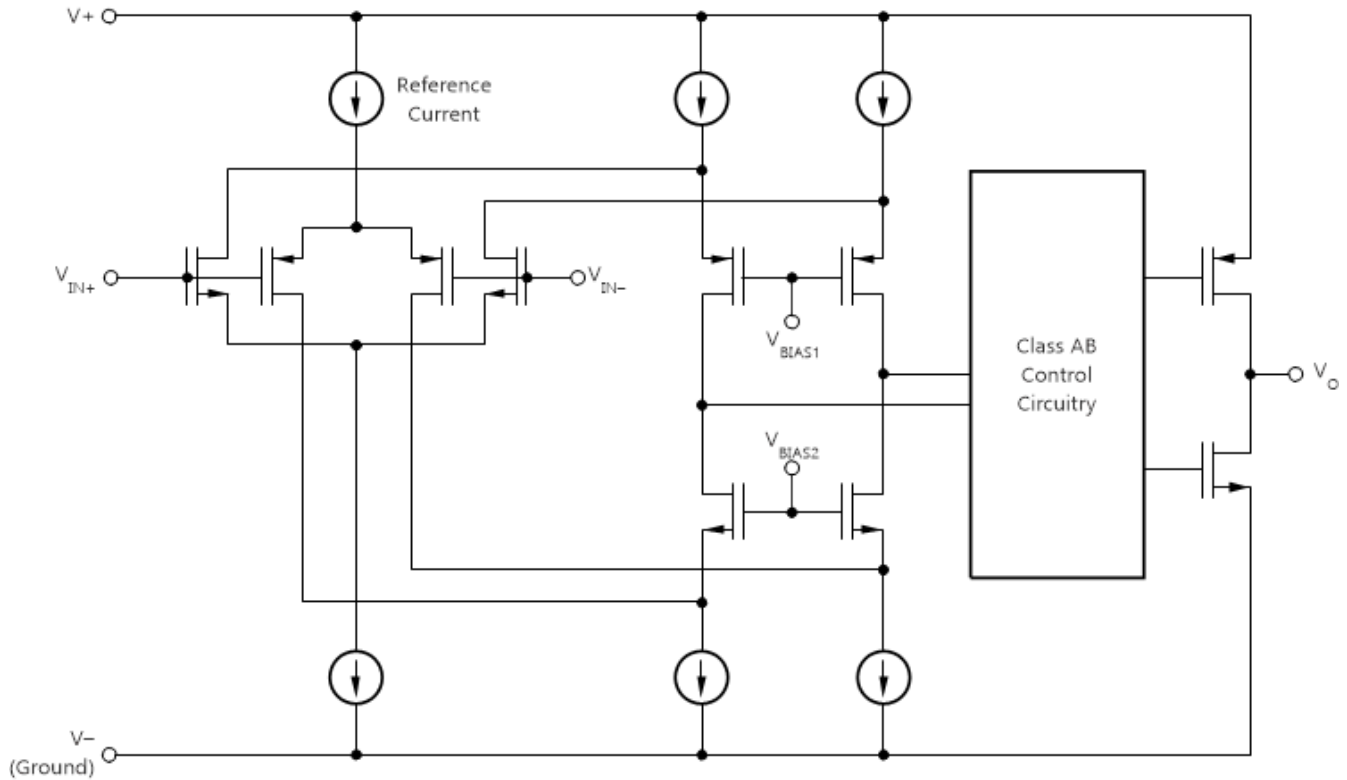


## 8 Detailed Description

### 8.1 Overview

The TLV905x devices are a 5-MHz family of low-power, rail-to-rail input and output op amps. These devices operate from 1.8 V to 5.5 V, are unity-gain stable, and are designed for a wide range of general-purpose applications. The input common-mode voltage range includes both rails and allows the TLV905x family to be used in virtually any single-supply application. The unique combination of a high slew rate and low quiescent current makes this family a potential choice for battery-powered motor-drive applications. Rail-to-rail input and output swing significantly increase dynamic range, especially in low-supply applications.

### 8.2 Functional Block Diagram



## 8.3 Feature Description

### 8.3.1 Operating Voltage

The TLV905x family of op amps is specified for operation from 1.8 V to 6.0 V. In addition, many specifications apply from  $-40^{\circ}\text{C}$  to  $125^{\circ}\text{C}$ . Parameters that vary significantly with operating voltages or temperature are illustrated in the [Section 7.8](#).

### 8.3.2 Rail-to-Rail Input

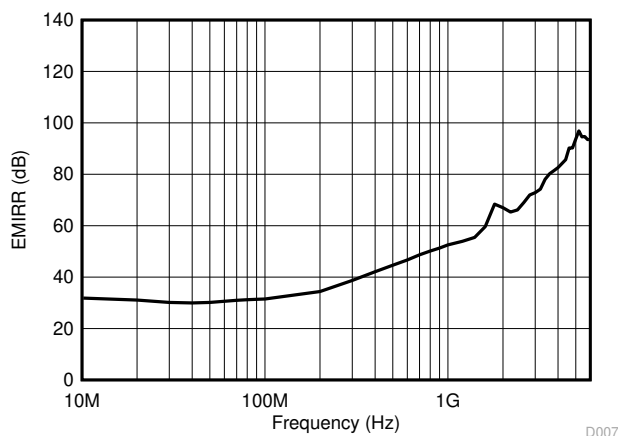
The input common-mode voltage range of the TLV905x family extends 100 mV beyond the supply rails for the full supply voltage range of 1.8 V to 6.0 V. This performance is achieved with a complementary input stage: an N-channel input differential pair in parallel with a P-channel differential pair, as shown in the [Section 8.2](#). The N-channel pair is active for input voltages close to the positive rail, typically  $(V+) - 1.4\text{ V}$  to 200 mV above the positive supply, whereas the P-channel pair is active for inputs from 200 mV below the negative supply to approximately  $(V+) - 1.4\text{ V}$ . There is a small transition region, typically  $(V+) - 1.2\text{ V}$  to  $(V+) - 1\text{ V}$ , in which both pairs are on. This 200-mV transition region can vary up to 200 mV with process variation. Thus, the transition region (with both stages on) can range from  $(V+) - 1.4\text{ V}$  to  $(V+) - 1.2\text{ V}$  on the low end, and up to  $(V+) - 1\text{ V}$  to  $(V+) - 0.8\text{ V}$  on the high end. Within this transition region, PSRR, CMRR, offset voltage, offset drift, and THD can degrade compared to device operation outside this region.

### 8.3.3 Rail-to-Rail Output

Designed as low-power, low-voltage operational amplifiers, the TLV905x family delivers a robust output drive capability. A class AB output stage with common-source transistors achieves full rail-to-rail output swing capability. For resistive loads of 10 k $\Omega$ , the output swings to within 16 mV of either supply rail, regardless of the applied power-supply voltage. Different load conditions change the ability of the amplifier to swing close to the rails.

### 8.3.4 EMI Rejection

The TLV905x uses integrated electromagnetic interference (EMI) filtering to reduce the effects of EMI from sources such as wireless communications and densely-populated boards with a mix of analog signal chain and digital components. EMI immunity can be improved with circuit design techniques; the TLV905x benefits from these design improvements. Texas Instruments has developed the ability to accurately measure and quantify the immunity of an operational amplifier over a broad frequency spectrum extending from 10 MHz to 6 GHz. [Figure 8-1](#) shows the results of this testing on the TLV905x. [Table 8-1](#) shows the EMIRR IN+ values for the TLV905x at particular frequencies commonly encountered in real-world applications. The [EMI Rejection Ratio of Operational Amplifiers](#) application report contains detailed information on the topic of EMIRR performance as it relates to op amps and is available for download from [www.ti.com](http://www.ti.com).



**Figure 8-1. EMIRR Testing**

**Table 8-1. TLV905x EMIRR IN+ for Frequencies of Interest**

FREQUENCY	APPLICATION OR ALLOCATION	EMIRR IN+
400 MHz	Mobile radio, mobile satellite, space operation, weather, radar, ultra-high frequency (UHF) applications	41.8 dB
900 MHz	Global system for mobile communications (GSM) applications, radio communication, navigation, GPS (to 1.6 GHz), GSM, aeronautical mobile, UHF applications	53.1 dB
1.8 GHz	GSM applications, mobile personal communications, broadband, satellite, L-band (1 GHz to 2 GHz)	71.8 dB
2.4 GHz	802.11b, 802.11g, 802.11n, Bluetooth®, mobile personal communications, industrial, scientific and medical (ISM) radio band, amateur radio and satellite, S-band (2 GHz to 4 GHz)	70.0 dB
3.6 GHz	Radiolocation, aero communication and navigation, satellite, mobile, S-band	81.2 dB
5 GHz	802.11a, 802.11n, aero communication and navigation, mobile communication, space and satellite operation, C-band (4 GHz to 8 GHz)	92.5 dB

### 8.3.5 Overload Recovery

Overload recovery is defined as the time required for the operational amplifier output to recover from a saturated state to a linear state. The output devices of the operational amplifier enter a saturation region when the output voltage exceeds the rated operating voltage, because of the high input voltage or high gain. After the device enters the saturation region, the output devices require time to return to the linear operating state. After the output devices return to their linear operating state, the device begins to slew at the specified slew rate. Therefore, the propagation delay (in case of an overload condition) is the sum of the overload recovery time and the slew time. The overload recovery time for the TLV905x family is approximately 300 ns.

### 8.3.6 Packages With an Exposed Thermal Pad

The TLV905x family is available in packages such as the WSON-8 (DSG) and WQFN-16 (RTE) which feature an exposed thermal pad. Inside the package, the die is attached to this thermal pad using an electrically conductive compound. For this reason, when using a package with an exposed thermal pad, the thermal pad must either be connected to V– or left floating. Attaching the thermal pad to a potential other than V– is not allowed, and the performance of the device is not verified when doing so.

### 8.3.7 Electrical Overstress

Designers often ask questions about the capability of an operational amplifier to withstand electrical overstress. These questions tend to focus on the device inputs, but can involve the supply voltage pins or even the output pin. Each of these different pin functions have electrical stress limits determined by the voltage breakdown characteristics of the particular semiconductor fabrication process and specific circuits connected to the pin. Additionally, internal electrostatic discharge (ESD) protection is built into these circuits to protect them from accidental ESD events both before and during product assembly.

Having a good understanding of this basic ESD circuitry and its relevance to an electrical overstress event is helpful. [Figure 8-2](#) shows the ESD circuits contained in the TLV905x devices. The ESD protection circuitry involves several current-steering diodes connected from the input and output pins and routed back to the internal power supply lines, where they meet at an absorption device internal to the operational amplifier. This protection circuitry is intended to remain inactive during normal circuit operation.



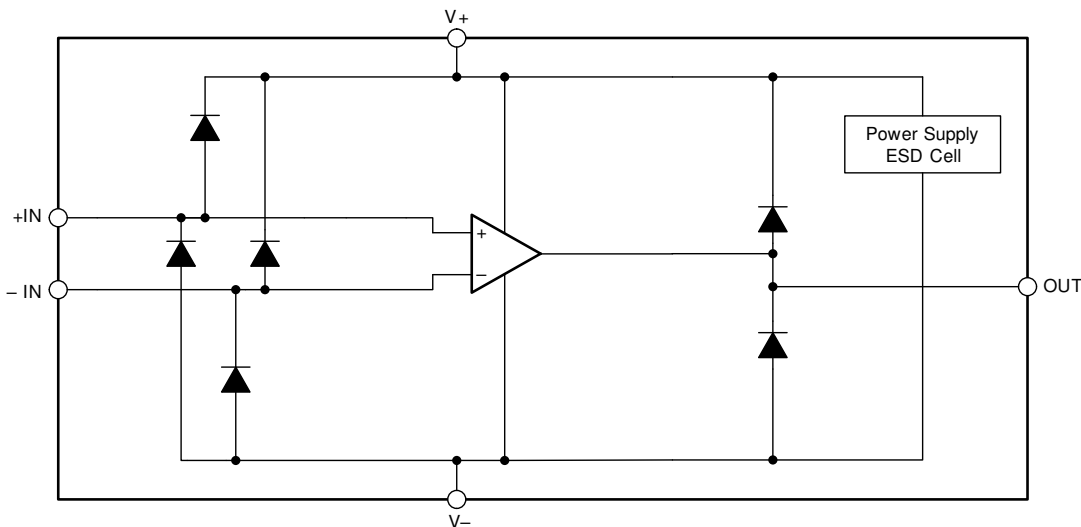


Figure 8-2. Equivalent Internal ESD Circuitry

### 8.3.8 Input Protection

The TLV905x family incorporates internal ESD protection circuits on all pins. For input and output pins, this protection primarily consists of current-steering diodes connected between the input and power-supply pins. These ESD protection diodes provide in-circuit, input overdrive protection, as long as the current is limited to 10 mA, as shown in the [Section 7.1](#). [Figure 8-3](#) shows how a series input resistor can be added to the driven input to limit the input current. The added resistor contributes thermal noise at the amplifier input and the value must be kept to a minimum in noise-sensitive applications.

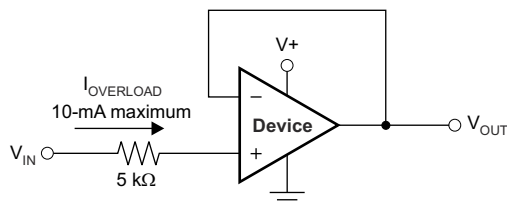


Figure 8-3. Input Current Protection

### 8.3.9 Shutdown Function

The TLV905xS devices feature  $\overline{\text{SHDN}}$  pins that disable the op amp, placing the device into a low-power standby mode. In this mode, the op amp typically consumes less than 1  $\mu\text{A}$ . The  $\overline{\text{SHDN}}$  pins are active low, meaning that shutdown mode is enabled when the input to the  $\overline{\text{SHDN}}$  pin is a valid logic low.

The  $\overline{\text{SHDN}}$  pins are referenced to the negative supply voltage of the op amp. The threshold of the shutdown feature lies around 800 mV (typical) and does not change with respect to the supply voltage. Hysteresis has been included in the switching threshold to ensure smooth switching characteristics. To ensure shutdown behavior, the  $\overline{\text{SHDN}}$  pins should be driven with valid logic signals. A valid logic low is defined as a voltage between  $V^-$  and  $V^- + 0.4$  V. A valid logic high is defined as a voltage between  $V^- + 1.2$  V and  $V^+$ . The shutdown pin circuitry includes a pull-up resistor, which will inherently pull the voltage of the pin to the positive supply rail if not driven. Thus, to enable the amplifier, the  $\overline{\text{SHDN}}$  pins must either be left floating or driven to a valid logic high. To disable the amplifier, the  $\overline{\text{SHDN}}$  pins must be driven to a valid logic low. While TI highly recommends that the shutdown pin be connected to a valid high or a low voltage or driven, TI has included a pull-up resistor connected to  $V_{CC}$ . The maximum voltage allowed at the  $\overline{\text{SHDN}}$  pins is  $(V^+) + 0.5$  V. Exceeding this voltage level will damage the device.

The  $\overline{\text{SHDN}}$  pins are high-impedance CMOS inputs. Dual op amp versions are independently controlled and quad op amp versions are controlled in pairs with logic inputs. For battery-operated applications, this feature

may be used to greatly reduce the average current and extend battery life. The enable time is 35  $\mu$ s for full shutdown of all channels; disable time is 6  $\mu$ s. When disabled, the output assumes a high-impedance state. This architecture allows the TLV905xS to be operated as a gated amplifier (or to have the device output multiplexed onto a common analog output bus). Shutdown time ( $t_{OFF}$ ) depends on loading conditions and increases as load resistance increases. To ensure shutdown (disable) within a specific shutdown time, the specified 10-k $\Omega$  load to midsupply ( $V_S / 2$ ) is required. If using the TLV905xS without a load, the resulting turnoff time is significantly increased.

## 8.4 Device Functional Modes

The TLV905x family is operational when the power-supply voltage is between 1.8 V ( $\pm 0.9$  V) and 6.0 V ( $\pm 3.0$  V).

The TLV905xS devices feature a shutdown mode and are shutdown when a valid logic low is applied to the shutdown pin.

## 9 Application and Implementation

### Note

Information in the following applications sections is not part of the TI component specification, and TI does not warrant its accuracy or completeness. TI's customers are responsible for determining suitability of components for their purposes, as well as validating and testing their design implementation to confirm system functionality.

### 9.1 Application Information

The TLV905x family features 5-MHz bandwidth and very high slew rate of 15 V/ $\mu$ s with only 330  $\mu$ A of supply current per channel, providing excellent AC performance at very low-power consumption. DC applications are well served with a very low input noise voltage of 15 nV/ $\sqrt{\text{Hz}}$  at 10 kHz, low input bias current, and a typical input offset voltage of 0.33 mV.

### 9.2 Typical Low-Side Current Sense Application

Figure 9-1 shows the TLV905x configured in a low-side current sensing application.

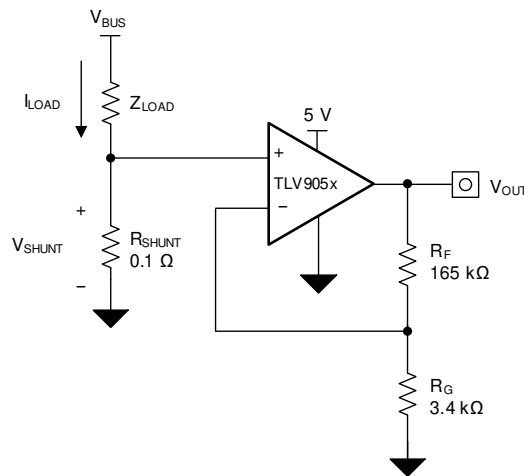


Figure 9-1. TLV905x in a Low-Side, Current-Sensing Application

#### 9.2.1 Design Requirements

The design requirements for this design are:

- Load current: 0 A to 1 A
- Output voltage: 4.95 V
- Maximum shunt voltage: 100 mV

### 9.2.2 Detailed Design Procedure

The transfer function of the circuit in [Figure 9-1](#) is given in [Equation 1](#).

$$V_{OUT} = I_{LOAD} \times R_{SHUNT} \times \text{Gain} \quad (1)$$

The load current ( $I_{LOAD}$ ) produces a voltage drop across the shunt resistor ( $R_{SHUNT}$ ). The load current is set from 0 A to 1 A. To keep the shunt voltage below 100 mV at maximum load current, the largest shunt resistor is defined using [Equation 2](#).

$$R_{SHUNT} = \frac{V_{SHUNT\_MAX}}{I_{LOAD\_MAX}} = \frac{100\text{ mV}}{1\text{ A}} = 100\text{ m}\Omega \quad (2)$$

Using [Equation 2](#),  $R_{SHUNT}$  equals 100 m $\Omega$ . The voltage drop produced by  $I_{LOAD}$  and  $R_{SHUNT}$  is amplified by the TLV905x device to produce an output voltage of approximately 0 V to 4.95 V. [Equation 3](#) calculates the gain required for the TLV905x device to produce the required output voltage.

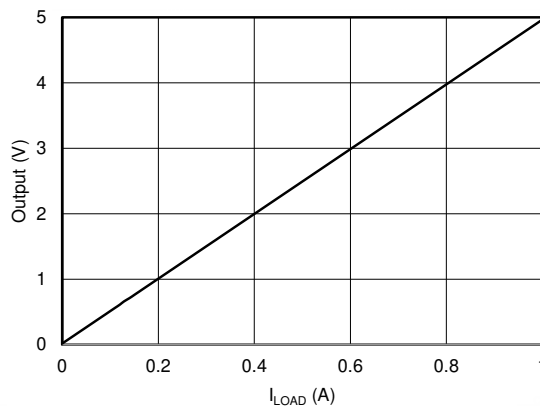
$$\text{Gain} = \frac{(V_{OUT\_MAX} - V_{OUT\_MIN})}{(V_{IN\_MAX} - V_{IN\_MIN})} \quad (3)$$

Using [Equation 3](#), the required gain equals 49.5 V/V, which is set with the  $R_F$  and  $R_G$  resistors. [Equation 4](#) sizes the  $R_F$  and  $R_G$ , resistors to set the gain of the TLV905x device to 49.5 V/V.

$$\text{Gain} = 1 + \frac{(R_F)}{(R_G)} \quad (4)$$

Selecting  $R_F$  to equal 165 k $\Omega$  and  $R_G$  to equal 3.4 k $\Omega$  provides a combination that equals approximately 49.5 V/V. [Figure 9-2](#) shows the measured transfer function of the circuit shown in [Figure 9-1](#).

### 9.2.3 Application Curve



**Figure 9-2. Low-Side, Current-Sense Transfer Function**

## 9.3 Power Supply Recommendations

The TLV905x family is specified for operation from 1.8 V to 6.0 V ( $\pm 0.9$  V to  $\pm 3.0$  V); many specifications apply from  $-40^{\circ}\text{C}$  to  $125^{\circ}\text{C}$ . The [Section 7.8](#) section presents parameters that can exhibit significant variance with regard to operating voltage or temperature.

### CAUTION

Supply voltages larger than 7 V can permanently damage the device; see the [Section 7.1](#) table.

Place 0.1- $\mu\text{F}$  bypass capacitors close to the power-supply pins to reduce errors coupling in from noisy or high-impedance power supplies. For more-detailed information on bypass capacitor placement, see the [Section 9.4.2](#) section.

## 9.4 Layout

### 9.4.1 Layout Guidelines

For best operational performance of the device, use good printed circuit board (PCB) layout practices, including:

- Noise can propagate into analog circuitry through the power pins of the circuit as a whole and of the op amp itself. Bypass capacitors are used to reduce the coupled noise by providing low-impedance power sources local to the analog circuitry.
  - Connect low-ESR, 0.1- $\mu\text{F}$  ceramic bypass capacitors between each supply pin and ground, placed as close to the device as possible. A single bypass capacitor from  $V+$  to ground is applicable for single-supply applications.
- Separate grounding for analog and digital portions of circuitry is one of the simplest and most-effective methods of noise suppression. One or more layers on multilayer PCBs are usually devoted to ground planes. A ground plane helps distribute heat and reduces electromagnetic interference (EMI) noise pickup. Take care to physically separate digital and analog grounds, paying attention to the flow of the ground current. For more detailed information, see [Circuit Board Layout Techniques](#).
- To reduce parasitic coupling, run the input traces as far away from the supply or output traces as possible. If these traces cannot be kept separate, crossing the sensitive trace perpendicular is much better as opposed to in parallel with the noisy trace.
- Place the external components as close to the device as possible. As illustrated in [Figure 9-4](#), keeping  $R_F$  and  $R_G$  close to the inverting input minimizes parasitic capacitance on the inverting input.
- Keep the length of input traces as short as possible. Always remember that the input traces are the most sensitive part of the circuit.
- Consider a driven, low-impedance guard ring around the critical traces. A guard ring can significantly reduce leakage currents from nearby traces that are at different potentials.
- Cleaning the PCB following board assembly is recommended for best performance.
- Any precision integrated circuit can experience performance shifts resulting from moisture ingress into the plastic package. Following any aqueous PCB cleaning process, baking the PCB assembly is recommended to remove moisture introduced into the device packaging during the cleaning process. A low-temperature, post-cleaning bake at  $85^{\circ}\text{C}$  for 30 minutes is sufficient for most circumstances.

### 9.4.2 Layout Example

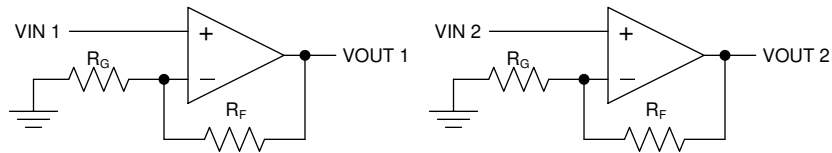


Figure 9-3. Schematic Representation for Figure 9-4

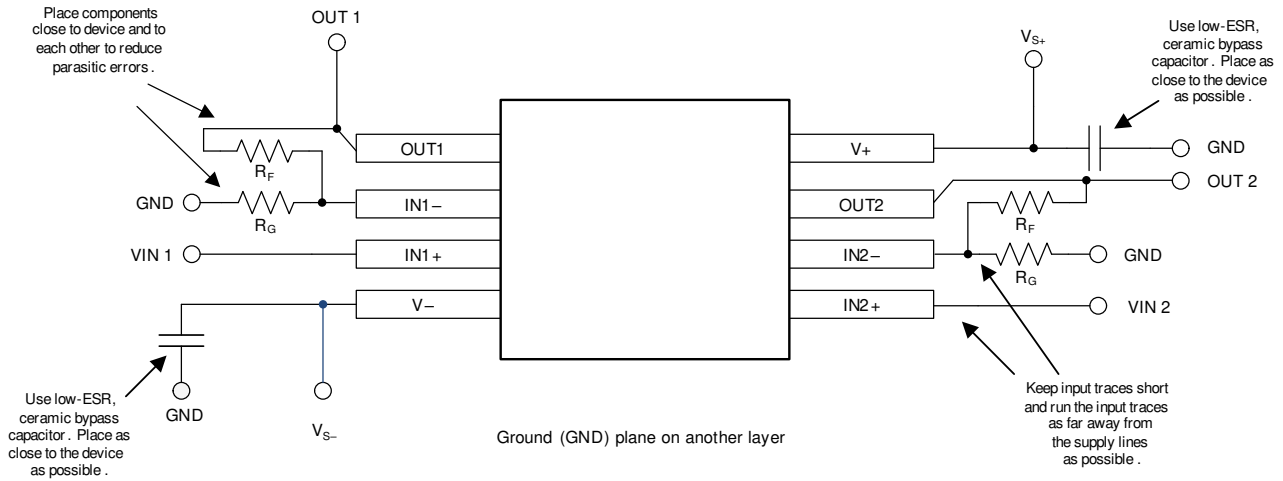


Figure 9-4. Layout Example

## 10 Device and Documentation Support

### 10.1 Documentation Support

#### 10.1.1 Related Documentation

Texas Instruments, [TLVx313 Low-Power, Rail-to-Rail In/Out, 500- \$\mu\$ V Typical Offset, 1-MHz Operational Amplifier for Cost-Sensitive Systems](#)

Texas Instruments, [TLVx314 3-MHz, Low-Power, Internal EMI Filter, RRIO, Operational Amplifier](#)

Texas Instruments, [EMI Rejection Ratio of Operational Amplifiers](#)

Texas Instruments, [QFN/SON PCB Attachment](#)

Texas Instruments, [Quad Flatpack No-Lead Logic Packages](#)

Texas Instruments, [Circuit Board Layout Techniques](#)

Texas Instruments, [Single-Ended Input to Differential Output Conversion Circuit Reference Design](#)

#### 10.2 Related Links

The table below lists quick access links. Categories include technical documents, support and community resources, tools and software, and quick access to order now.

**Table 10-1. Related Links**

PARTS	PRODUCT FOLDER	ORDER NOW	TECHNICAL DOCUMENTS	TOOLS & SOFTWARE	SUPPORT & COMMUNITY
TLV9051/S	<a href="#">Click here</a>	<a href="#">Click here</a>	<a href="#">Click here</a>	<a href="#">Click here</a>	<a href="#">Click here</a>
TLV9052/S	<a href="#">Click here</a>	<a href="#">Click here</a>	<a href="#">Click here</a>	<a href="#">Click here</a>	<a href="#">Click here</a>
TLV9054/S	<a href="#">Click here</a>	<a href="#">Click here</a>	<a href="#">Click here</a>	<a href="#">Click here</a>	<a href="#">Click here</a>

#### 10.3 Receiving Notification of Documentation Updates

To receive notification of documentation updates, navigate to the device product folder on ti.com. In the upper right corner, click on *Alert me* to register and receive a weekly digest of any product information that has changed. For change details, review the revision history included in any revised document.

#### 10.4 Support Resources

[TI E2E™ support forums](#) are an engineer's go-to source for fast, verified answers and design help — straight from the experts. Search existing answers or ask your own question to get the quick design help you need.

Linked content is provided "AS IS" by the respective contributors. They do not constitute TI specifications and do not necessarily reflect TI's views; see TI's [Terms of Use](#).

#### 10.5 Trademarks

TI E2E™ is a trademark of Texas Instruments.

Bluetooth® is a registered trademark of Bluetooth SIG, Inc.

All trademarks are the property of their respective owners.

#### 10.6 Electrostatic Discharge Caution



This integrated circuit can be damaged by ESD. Texas Instruments recommends that all integrated circuits be handled with appropriate precautions. Failure to observe proper handling and installation procedures can cause damage.

ESD damage can range from subtle performance degradation to complete device failure. Precision integrated circuits may be more susceptible to damage because very small parametric changes could cause the device not to meet its published specifications.

#### 10.7 Glossary

[TI Glossary](#) This glossary lists and explains terms, acronyms, and definitions.

## 11 Mechanical, Packaging, and Orderable Information

The following pages include mechanical, packaging, and orderable information. This information is the most-current data available for the designated devices. This data is subject to change without notice and without revision of this document. For browser-based versions of this data sheet, see the left-hand navigation pane.



**PACKAGING INFORMATION**

Orderable Device	Status (1)	Package Type	Package Drawing	Pins	Package Qty	Eco Plan (2)	Lead finish/ Ball material (6)	MSL Peak Temp (3)	Op Temp (°C)	Device Marking (4/5)	Samples
TLV9051IDBVR	ACTIVE	SOT-23	DBV	5	3000	RoHS & Green	NIPDAU   SN	Level-1-260C-UNLIM	-40 to 125	T51D	<a href="#">Samples</a>
TLV9051IDCKR	ACTIVE	SC70	DCK	5	3000	RoHS & Green	SN	Level-2-260C-1 YEAR	-40 to 125	T51	<a href="#">Samples</a>
TLV9051DPWR	ACTIVE	X2SON	DPW	5	3000	RoHS & Green	NIPDAUAG	Level-2-260C-1 YEAR	-40 to 125	FH	<a href="#">Samples</a>
TLV9051SIDBVR	ACTIVE	SOT-23	DBV	6	3000	RoHS & Green	NIPDAU	Level-1-260C-UNLIM	-40 to 125	T51S	<a href="#">Samples</a>
TLV9052IDDFR	ACTIVE	SOT-23-THIN	DDF	8	3000	RoHS & Green	NIPDAU	Level-1-260C-UNLIM	-40 to 125	T052	<a href="#">Samples</a>
TLV9052IDGKR	ACTIVE	VSSOP	DGK	8	2500	RoHS & Green	NIPDAU   SN   NIPDAUAG	Level-2-260C-1 YEAR	-40 to 125	1PWX	<a href="#">Samples</a>
TLV9052IDR	ACTIVE	SOIC	D	8	2500	RoHS & Green	NIPDAU	Level-2-260C-1 YEAR	-40 to 125	TL9052	<a href="#">Samples</a>
TLV9052IDSGR	ACTIVE	WSON	DSG	8	3000	RoHS & Green	NIPDAU	Level-1-260C-UNLIM	-40 to 125	9052	<a href="#">Samples</a>
TLV9052IPWR	ACTIVE	TSSOP	PW	8	2000	RoHS & Green	NIPDAU	Level-2-260C-1 YEAR	-40 to 125	TL9052	<a href="#">Samples</a>
TLV9052SIDGSR	ACTIVE	VSSOP	DGS	10	2500	RoHS & Green	NIPDAUAG	Level-2-260C-1 YEAR	-40 to 125	T052	<a href="#">Samples</a>
TLV9052SIRUGR	ACTIVE	X2QFN	RUG	10	3000	RoHS & Green	NIPDAUAG	Level-2-260C-1 YEAR	-40 to 125	FPF	<a href="#">Samples</a>
TLV9054IDR	ACTIVE	SOIC	D	14	2500	RoHS & Green	NIPDAU	Level-2-260C-1 YEAR	-40 to 125	TLV9054D	<a href="#">Samples</a>
TLV9054IPWR	ACTIVE	TSSOP	PW	14	2000	RoHS & Green	SN	Level-2-260C-1 YEAR	-40 to 125	T9054PW	<a href="#">Samples</a>
TLV9054IRTER	ACTIVE	WQFN	RTE	16	3000	RoHS & Green	NIPDAU	Level-1-260C-UNLIM	-40 to 125	T54RT	<a href="#">Samples</a>
TLV9054IRUCR	ACTIVE	QFN	RUC	14	3000	RoHS & Green	NIPDAU	Level-2-260C-1 YEAR	-40 to 125	1FF	<a href="#">Samples</a>
TLV9054SIRTER	ACTIVE	WQFN	RTE	16	3000	RoHS & Green	NIPDAU	Level-1-260C-UNLIM	-40 to 125	T9054S	<a href="#">Samples</a>

(1) The marketing status values are defined as follows:

**ACTIVE:** Product device recommended for new designs.

**LIFEBUY:** TI has announced that the device will be discontinued, and a lifetime-buy period is in effect.

**NRND:** Not recommended for new designs. Device is in production to support existing customers, but TI does not recommend using this part in a new design.

**PREVIEW:** Device has been announced but is not in production. Samples may or may not be available.

**OBSOLETE:** TI has discontinued the production of the device.

(2) **RoHS:** TI defines "RoHS" to mean semiconductor products that are compliant with the current EU RoHS requirements for all 10 RoHS substances, including the requirement that RoHS substance do not exceed 0.1% by weight in homogeneous materials. Where designed to be soldered at high temperatures, "RoHS" products are suitable for use in specified lead-free processes. TI may reference these types of products as "Pb-Free".

**RoHS Exempt:** TI defines "RoHS Exempt" to mean products that contain lead but are compliant with EU RoHS pursuant to a specific EU RoHS exemption.

**Green:** TI defines "Green" to mean the content of Chlorine (Cl) and Bromine (Br) based flame retardants meet JS709B low halogen requirements of  $\leq 1000$ ppm threshold. Antimony trioxide based flame retardants must also meet the  $\leq 1000$ ppm threshold requirement.

(3) MSL, Peak Temp. - The Moisture Sensitivity Level rating according to the JEDEC industry standard classifications, and peak solder temperature.

(4) There may be additional marking, which relates to the logo, the lot trace code information, or the environmental category on the device.

(5) Multiple Device Markings will be inside parentheses. Only one Device Marking contained in parentheses and separated by a "~" will appear on a device. If a line is indented then it is a continuation of the previous line and the two combined represent the entire Device Marking for that device.

(6) Lead finish/Ball material - Orderable Devices may have multiple material finish options. Finish options are separated by a vertical ruled line. Lead finish/Ball material values may wrap to two lines if the finish value exceeds the maximum column width.

**Important Information and Disclaimer:**The information provided on this page represents TI's knowledge and belief as of the date that it is provided. TI bases its knowledge and belief on information provided by third parties, and makes no representation or warranty as to the accuracy of such information. Efforts are underway to better integrate information from third parties. TI has taken and continues to take reasonable steps to provide representative and accurate information but may not have conducted destructive testing or chemical analysis on incoming materials and chemicals. TI and TI suppliers consider certain information to be proprietary, and thus CAS numbers and other limited information may not be available for release.

In no event shall TI's liability arising out of such information exceed the total purchase price of the TI part(s) at issue in this document sold by TI to Customer on an annual basis.

**TAPE AND REEL INFORMATION**

**QUADRANT ASSIGNMENTS FOR PIN 1 ORIENTATION IN TAPE**


\*All dimensions are nominal

Device	Package Type	Package Drawing	Pins	SPQ	Reel Diameter (mm)	Reel Width W1 (mm)	A0 (mm)	B0 (mm)	K0 (mm)	P1 (mm)	W (mm)	Pin1 Quadrant
TLV9051IDBVR	SOT-23	DBV	5	3000	180.0	8.4	3.2	3.2	1.4	4.0	8.0	Q3
TLV9051IDCKR	SC70	DCK	5	3000	178.0	9.0	2.4	2.5	1.2	4.0	8.0	Q3
TLV9051IDPWR	X2SON	DPW	5	3000	178.0	8.4	0.91	0.91	0.5	2.0	8.0	Q2
TLV9051SIDBVR	SOT-23	DBV	6	3000	180.0	8.4	3.2	3.2	1.4	4.0	8.0	Q3
TLV9052IDDFR	SOT-23-THIN	DDF	8	3000	180.0	8.4	3.2	3.2	1.4	4.0	8.0	Q3
TLV9052IDGKR	VSSOP	DGK	8	2500	330.0	12.4	5.3	3.4	1.4	8.0	12.0	Q1
TLV9052IDGKR	VSSOP	DGK	8	2500	330.0	12.4	5.3	3.4	1.4	8.0	12.0	Q1
TLV9052IDSGR	WSO	DSG	8	3000	180.0	8.4	2.3	2.3	1.15	4.0	8.0	Q2
TLV9052IPWR	TSSOP	PW	8	2000	330.0	12.4	7.0	3.6	1.6	8.0	12.0	Q1
TLV9052SIDGSR	VSSOP	DGS	10	2500	330.0	12.4	5.3	3.4	1.4	8.0	12.0	Q1
TLV9052SIRUGR	X2QFN	RUG	10	3000	178.0	8.4	1.75	2.25	0.56	4.0	8.0	Q1
TLV9054IDR	SOIC	D	14	2500	330.0	16.4	6.5	9.0	2.1	8.0	16.0	Q1
TLV9054IPWR	TSSOP	PW	14	2000	330.0	12.4	6.9	5.6	1.6	8.0	12.0	Q1
TLV9054IRTER	WQFN	RTE	16	3000	330.0	12.4	3.3	3.3	1.1	8.0	12.0	Q2
TLV9054IRUCR	QFN	RUC	14	3000	180.0	9.5	2.16	2.16	0.5	4.0	8.0	Q2

---

Device	Package Type	Package Drawing	Pins	SPQ	Reel Diameter (mm)	Reel Width W1 (mm)	A0 (mm)	B0 (mm)	K0 (mm)	P1 (mm)	W (mm)	Pin1 Quadrant
TLV9054SIRTER	WQFN	RTE	16	3000	330.0	12.4	3.3	3.3	1.1	8.0	12.0	Q2

**TAPE AND REEL BOX DIMENSIONS**


\*All dimensions are nominal

Device	Package Type	Package Drawing	Pins	SPQ	Length (mm)	Width (mm)	Height (mm)
TLV9051IDBVR	SOT-23	DBV	5	3000	210.0	185.0	35.0
TLV9051IDCKR	SC70	DCK	5	3000	190.0	190.0	30.0
TLV9051IDPWR	X2SON	DPW	5	3000	205.0	200.0	33.0
TLV9051SIDBVR	SOT-23	DBV	6	3000	210.0	185.0	35.0
TLV9052IDDFR	SOT-23-THIN	DDF	8	3000	210.0	185.0	35.0
TLV9052IDGKR	VSSOP	DGK	8	2500	366.0	364.0	50.0
TLV9052IDGKR	VSSOP	DGK	8	2500	366.0	364.0	50.0
TLV9052IDSGR	WSON	DSG	8	3000	210.0	185.0	35.0
TLV9052IPWR	TSSOP	PW	8	2000	356.0	356.0	35.0
TLV9052SIDGSR	VSSOP	DGS	10	2500	366.0	364.0	50.0
TLV9052SIRUGR	X2QFN	RUG	10	3000	205.0	200.0	33.0
TLV9054IDR	SOIC	D	14	2500	356.0	356.0	35.0
TLV9054IPWR	TSSOP	PW	14	2000	366.0	364.0	50.0
TLV9054IRTER	WQFN	RTE	16	3000	367.0	367.0	35.0
TLV9054IRUCR	QFN	RUC	14	3000	205.0	200.0	30.0
TLV9054SIRTER	WQFN	RTE	16	3000	367.0	367.0	35.0

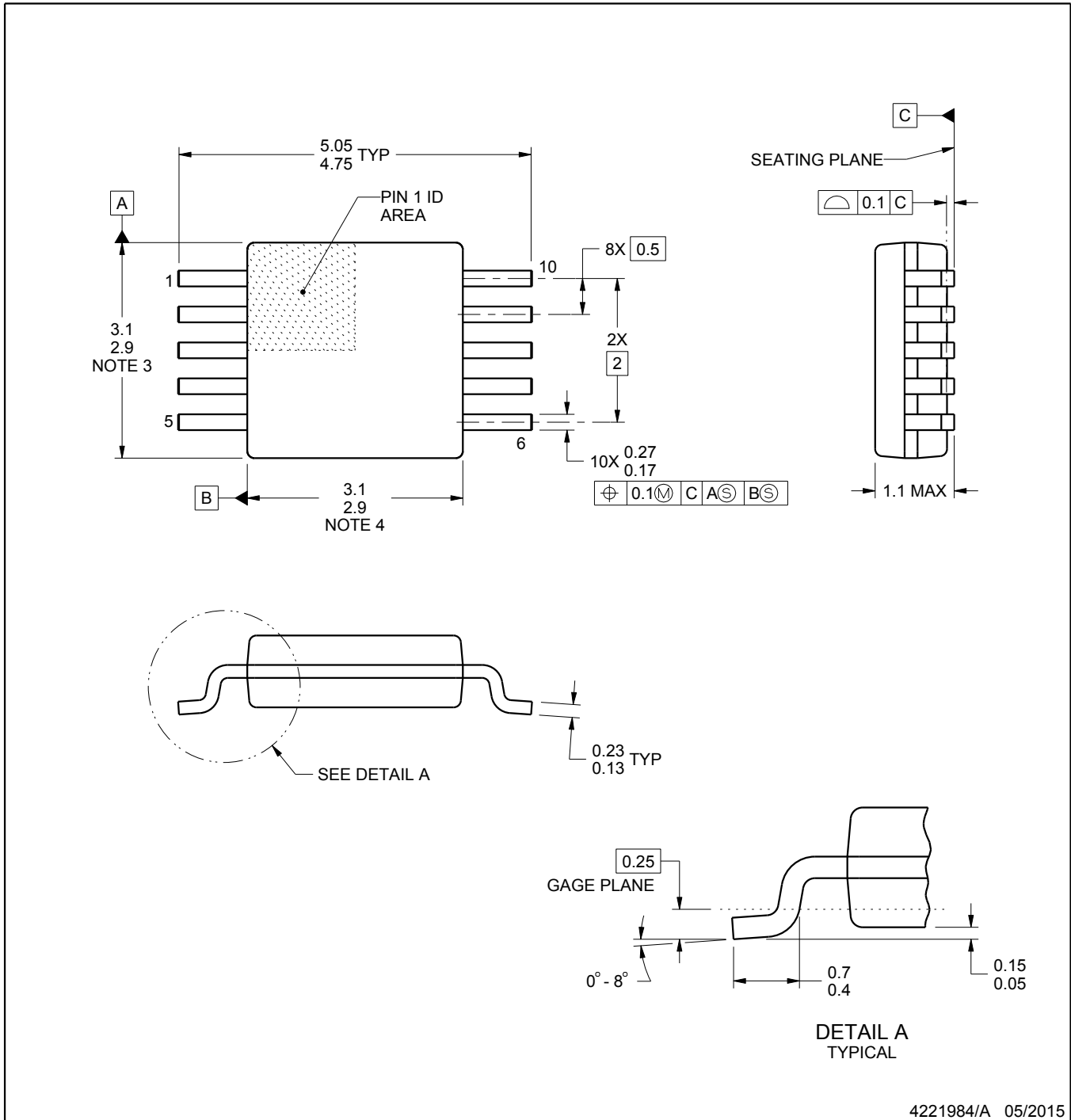
# DGS0010A



# PACKAGE OUTLINE

## VSSOP - 1.1 mm max height

SMALL OUTLINE PACKAGE



### NOTES:

1. All linear dimensions are in millimeters. Any dimensions in parenthesis are for reference only. Dimensioning and tolerancing per ASME Y14.5M.
2. This drawing is subject to change without notice.
3. This dimension does not include mold flash, protrusions, or gate burrs. Mold flash, protrusions, or gate burrs shall not exceed 0.15 mm per side.
4. This dimension does not include interlead flash. Interlead flash shall not exceed 0.25 mm per side.
5. Reference JEDEC registration MO-187, variation BA.

# EXAMPLE BOARD LAYOUT

DGS0010A

VSSOP - 1.1 mm max height

SMALL OUTLINE PACKAGE



LAND PATTERN EXAMPLE  
SCALE:10X



SOLDER MASK DETAILS  
NOT TO SCALE

4221984/A 05/2015

NOTES: (continued)

- 6. Publication IPC-7351 may have alternate designs.
- 7. Solder mask tolerances between and around signal pads can vary based on board fabrication site.

# EXAMPLE STENCIL DESIGN

DGS0010A

VSSOP - 1.1 mm max height

SMALL OUTLINE PACKAGE



SOLDER PASTE EXAMPLE  
BASED ON 0.125 mm THICK STENCIL  
SCALE:10X

4221984/A 05/2015

NOTES: (continued)

8. Laser cutting apertures with trapezoidal walls and rounded corners may offer better paste release. IPC-7525 may have alternate design recommendations.
9. Board assembly site may have different recommendations for stencil design.



## GENERIC PACKAGE VIEW

DPW 5

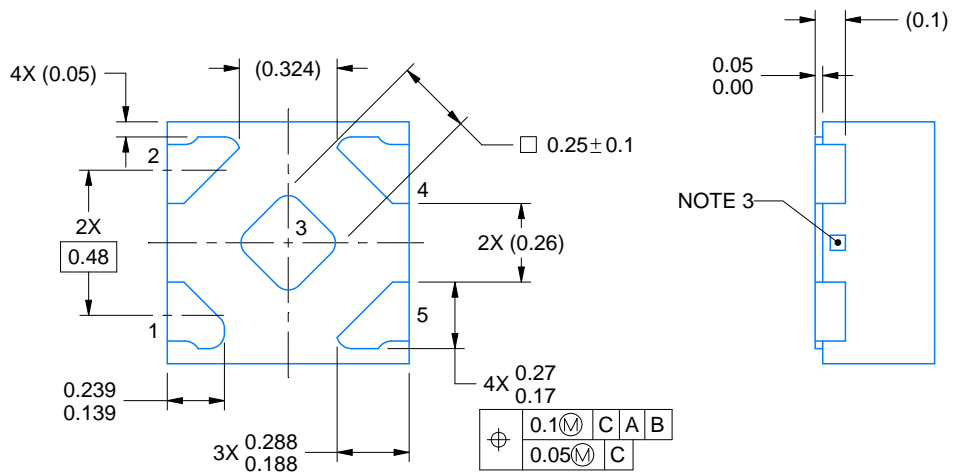
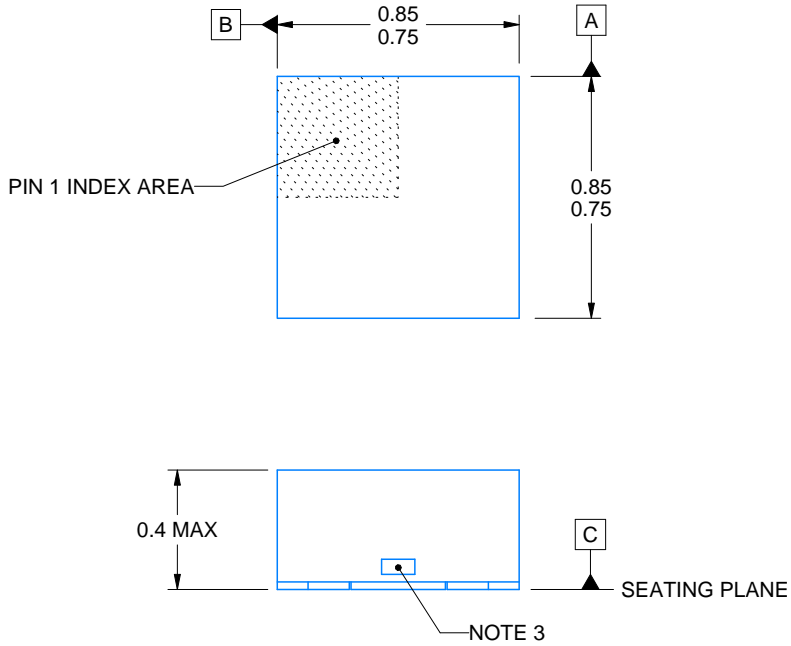
X2SON - 0.4 mm max height

PLASTIC SMALL OUTLINE - NO LEAD



Images above are just a representation of the package family, actual package may vary.  
Refer to the product data sheet for package details.

4211218-3/D



4223102/D 03/2022

NOTES:

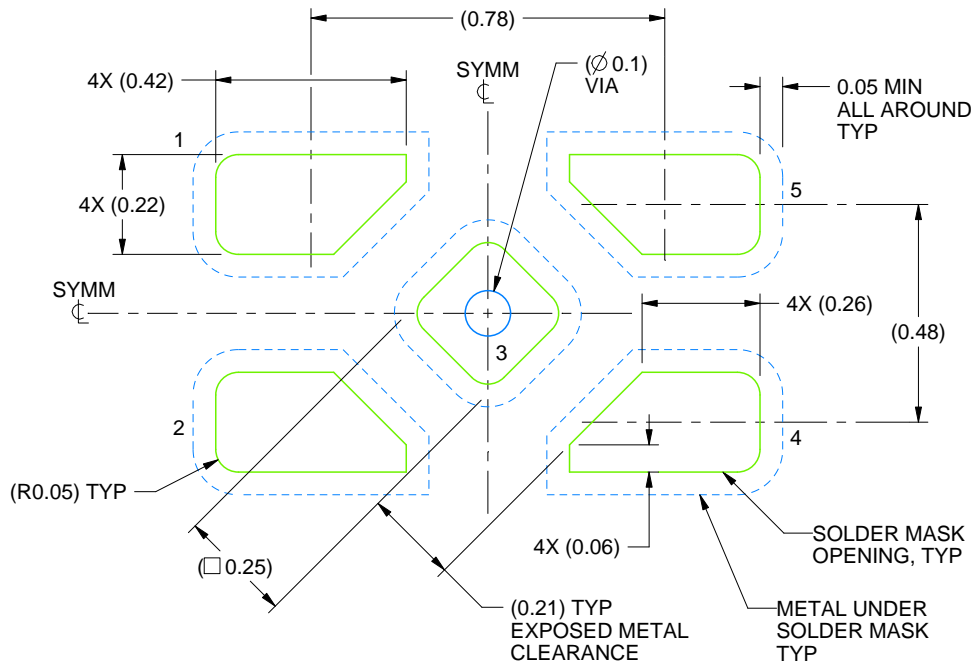
1. All linear dimensions are in millimeters. Any dimensions in parenthesis are for reference only. Dimensioning and tolerancing per ASME Y14.5M.
2. This drawing is subject to change without notice.
3. The size and shape of this feature may vary.

# EXAMPLE BOARD LAYOUT

DPW0005A

X2SON - 0.4 mm max height

PLASTIC SMALL OUTLINE - NO LEAD



LAND PATTERN EXAMPLE  
SOLDER MASK DEFINED  
SCALE:60X

4223102/D 03/2022

NOTES: (continued)

4. This package is designed to be soldered to a thermal pad on the board. For more information, refer to QFN/SON PCB application note in literature No. SLUA271 ([www.ti.com/lit/slua271](http://www.ti.com/lit/slua271)).

# EXAMPLE STENCIL DESIGN

DPW0005A

X2SON - 0.4 mm max height

PLASTIC SMALL OUTLINE - NO LEAD



SOLDER PASTE EXAMPLE  
BASED ON 0.1 mm THICK STENCIL

EXPOSED PAD 3  
92% PRINTED SOLDER COVERAGE BY AREA UNDER PACKAGE  
SCALE:100X

4223102/D 03/2022

NOTES: (continued)

5. Laser cutting apertures with trapezoidal walls and rounded corners may offer better paste release. IPC-7525 may have alternate design recommendations.

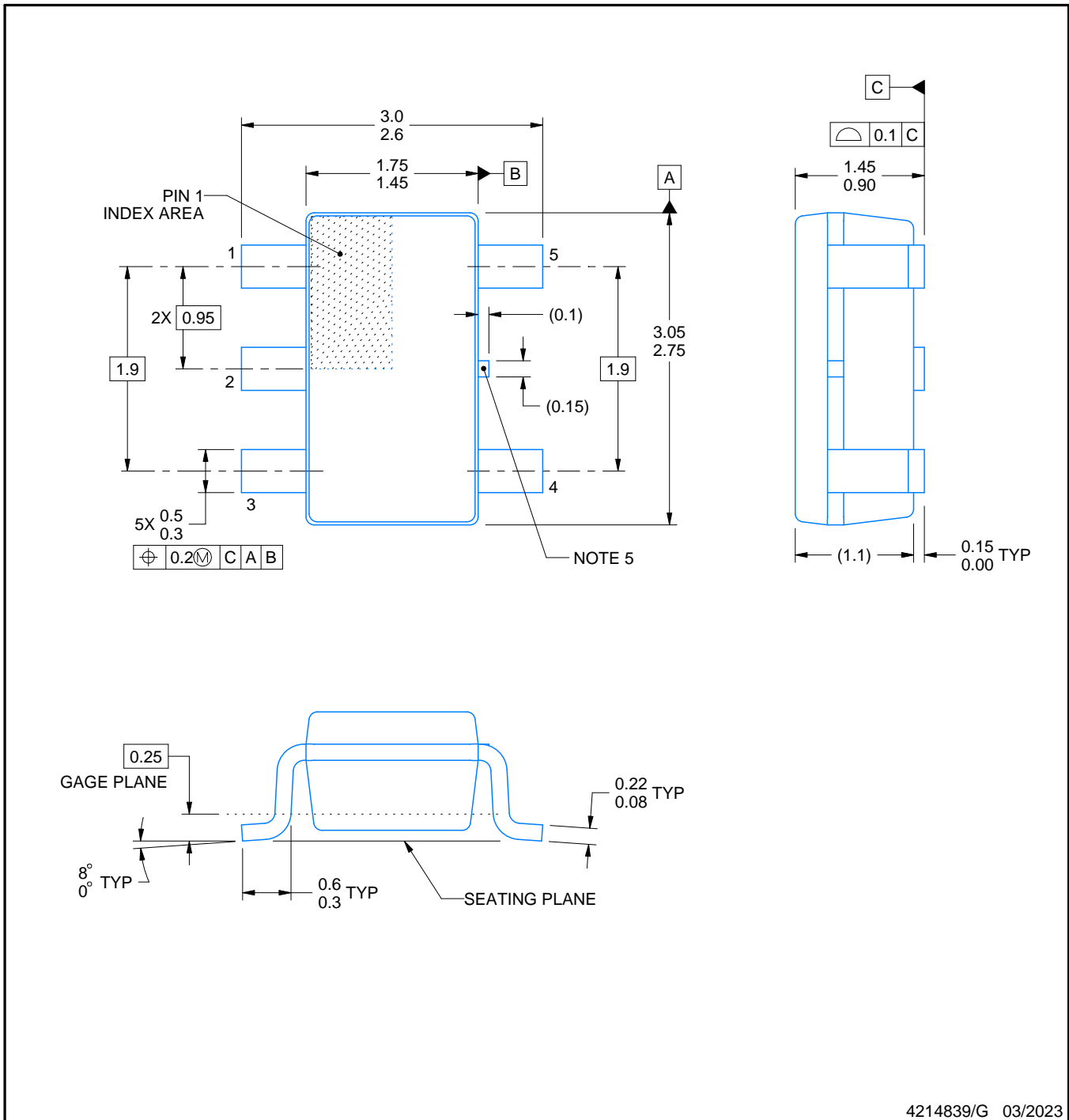
DBV0005A



# PACKAGE OUTLINE

SOT-23 - 1.45 mm max height

SMALL OUTLINE TRANSISTOR



4214839/G 03/2023

## NOTES:

1. All linear dimensions are in millimeters. Any dimensions in parenthesis are for reference only. Dimensioning and tolerancing per ASME Y14.5M.
2. This drawing is subject to change without notice.
3. Reference JEDEC MO-178.
4. Body dimensions do not include mold flash, protrusions, or gate burrs. Mold flash, protrusions, or gate burrs shall not exceed 0.25 mm per side.
5. Support pin may differ or may not be present.

# EXAMPLE BOARD LAYOUT

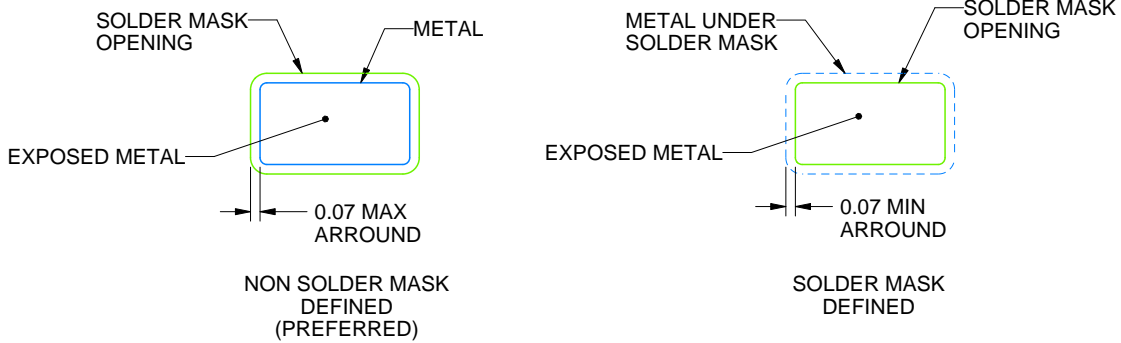
DBV0005A

SOT-23 - 1.45 mm max height

SMALL OUTLINE TRANSISTOR



LAND PATTERN EXAMPLE  
EXPOSED METAL SHOWN  
SCALE:15X



SOLDER MASK DETAILS

4214839/G 03/2023

NOTES: (continued)

- 6. Publication IPC-7351 may have alternate designs.
- 7. Solder mask tolerances between and around signal pads can vary based on board fabrication site.

# EXAMPLE STENCIL DESIGN

DBV0005A

SOT-23 - 1.45 mm max height

SMALL OUTLINE TRANSISTOR



SOLDER PASTE EXAMPLE  
BASED ON 0.125 mm THICK STENCIL  
SCALE:15X

4214839/G 03/2023

NOTES: (continued)

8. Laser cutting apertures with trapezoidal walls and rounded corners may offer better paste release. IPC-7525 may have alternate design recommendations.
9. Board assembly site may have different recommendations for stencil design.

D (R-PDSO-G14)

PLASTIC SMALL OUTLINE



- NOTES:
- A. All linear dimensions are in inches (millimeters).
  - B. This drawing is subject to change without notice.
  - $\triangle C$  Body length does not include mold flash, protrusions, or gate burrs. Mold flash, protrusions, or gate burrs shall not exceed 0.006 (0,15) each side.
  - $\triangle D$  Body width does not include interlead flash. Interlead flash shall not exceed 0.017 (0,43) each side.
  - E. Reference JEDEC MS-012 variation AB.



D (R-PDSO-G14)

PLASTIC SMALL OUTLINE



4211283-3/E 08/12

- NOTES:
- A. All linear dimensions are in millimeters.
  - B. This drawing is subject to change without notice.
  - C. Publication IPC-7351 is recommended for alternate designs.
  - D. Laser cutting apertures with trapezoidal walls and also rounding corners will offer better paste release. Customers should contact their board assembly site for stencil design recommendations. Refer to IPC-7525 for other stencil recommendations.
  - E. Customers should contact their board fabrication site for solder mask tolerances between and around signal pads.

PW (R-PDSO-G14)

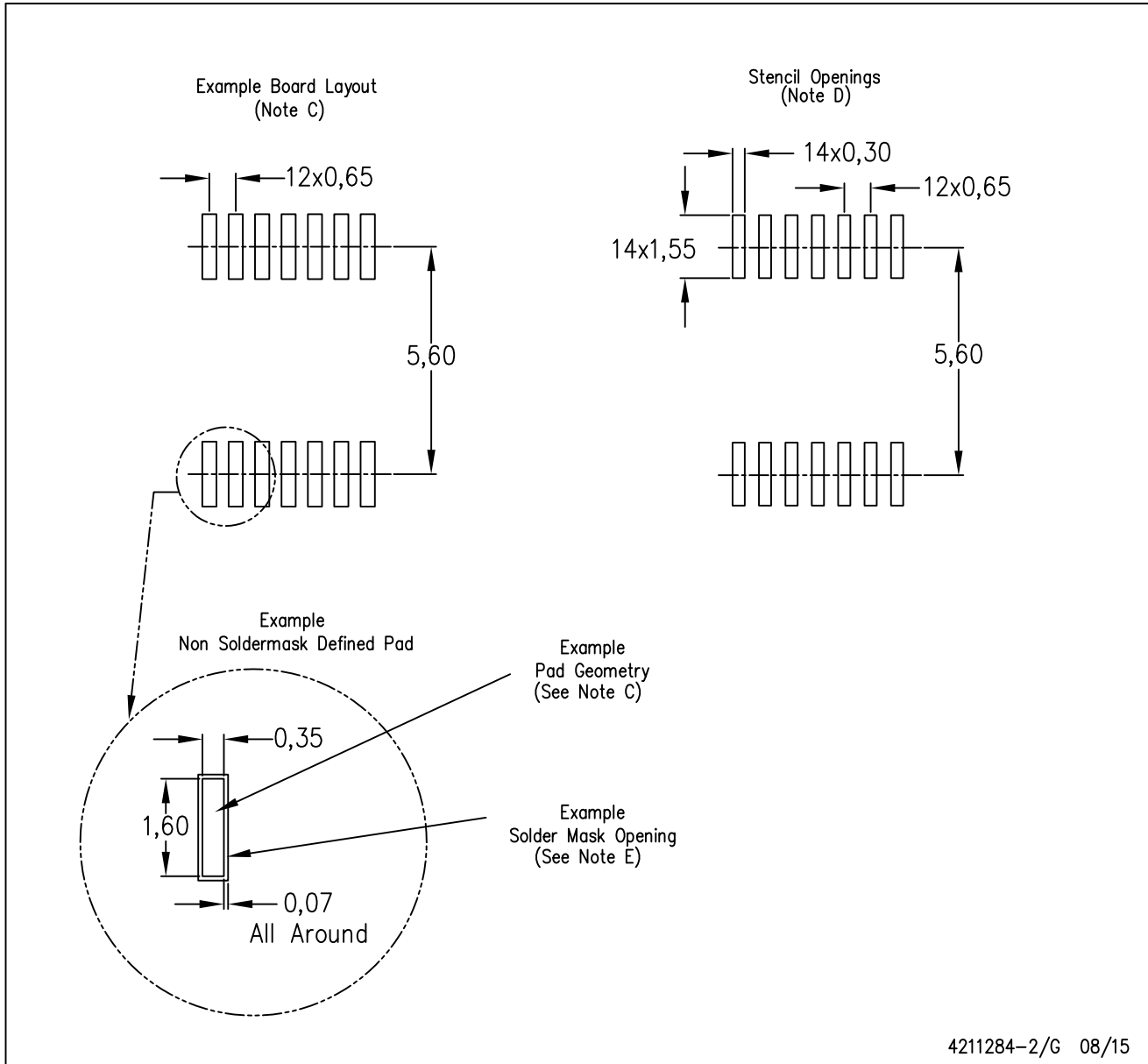
PLASTIC SMALL OUTLINE



- NOTES:
- A. All linear dimensions are in millimeters. Dimensioning and tolerancing per ASME Y14.5M-1994.
  - B. This drawing is subject to change without notice.
  - C. Body length does not include mold flash, protrusions, or gate burrs. Mold flash, protrusions, or gate burrs shall not exceed 0,15 each side.
  - D. Body width does not include interlead flash. Interlead flash shall not exceed 0,25 each side.
  - E. Falls within JEDEC MO-153

PW (R-PDSO-G14)

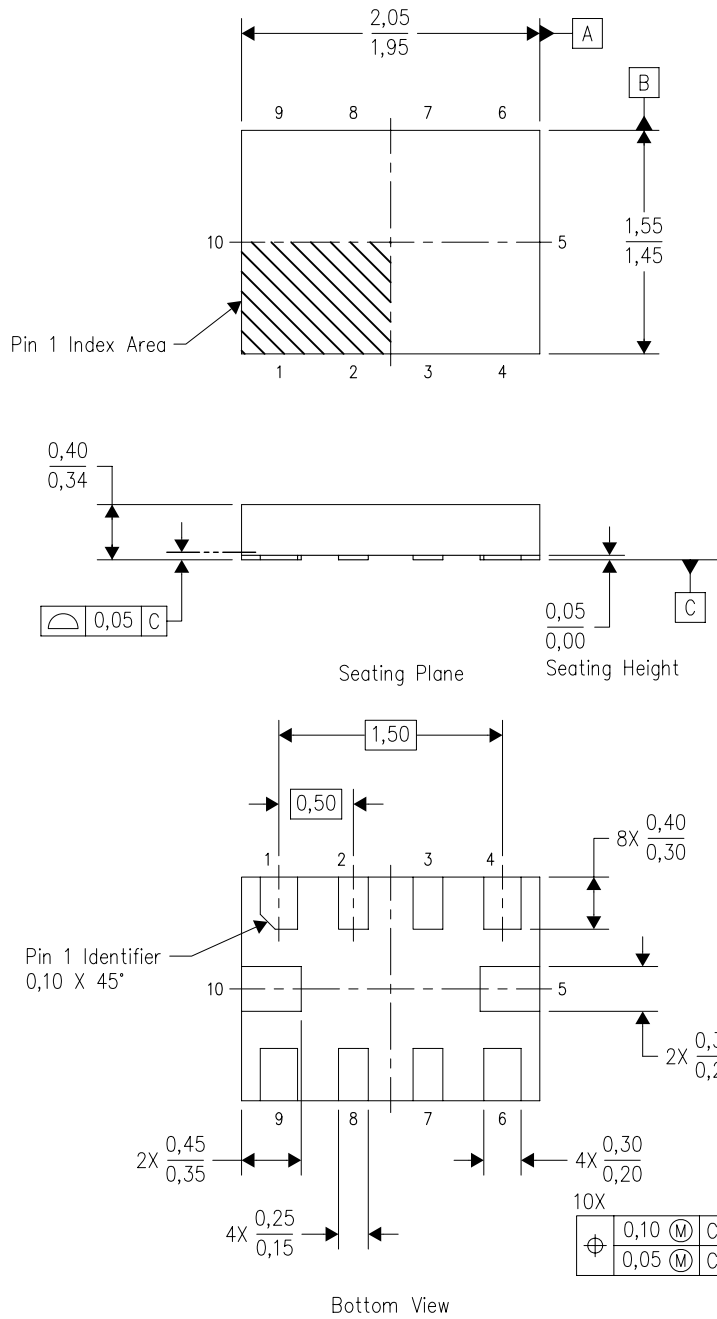
PLASTIC SMALL OUTLINE



- NOTES:
- All linear dimensions are in millimeters.
  - This drawing is subject to change without notice.
  - Publication IPC-7351 is recommended for alternate designs.
  - Laser cutting apertures with trapezoidal walls and also rounding corners will offer better paste release. Customers should contact their board assembly site for stencil design recommendations. Refer to IPC-7525 for other stencil recommendations.
  - Customers should contact their board fabrication site for solder mask tolerances between and around signal pads.

RUG (R-PQFP-N10)

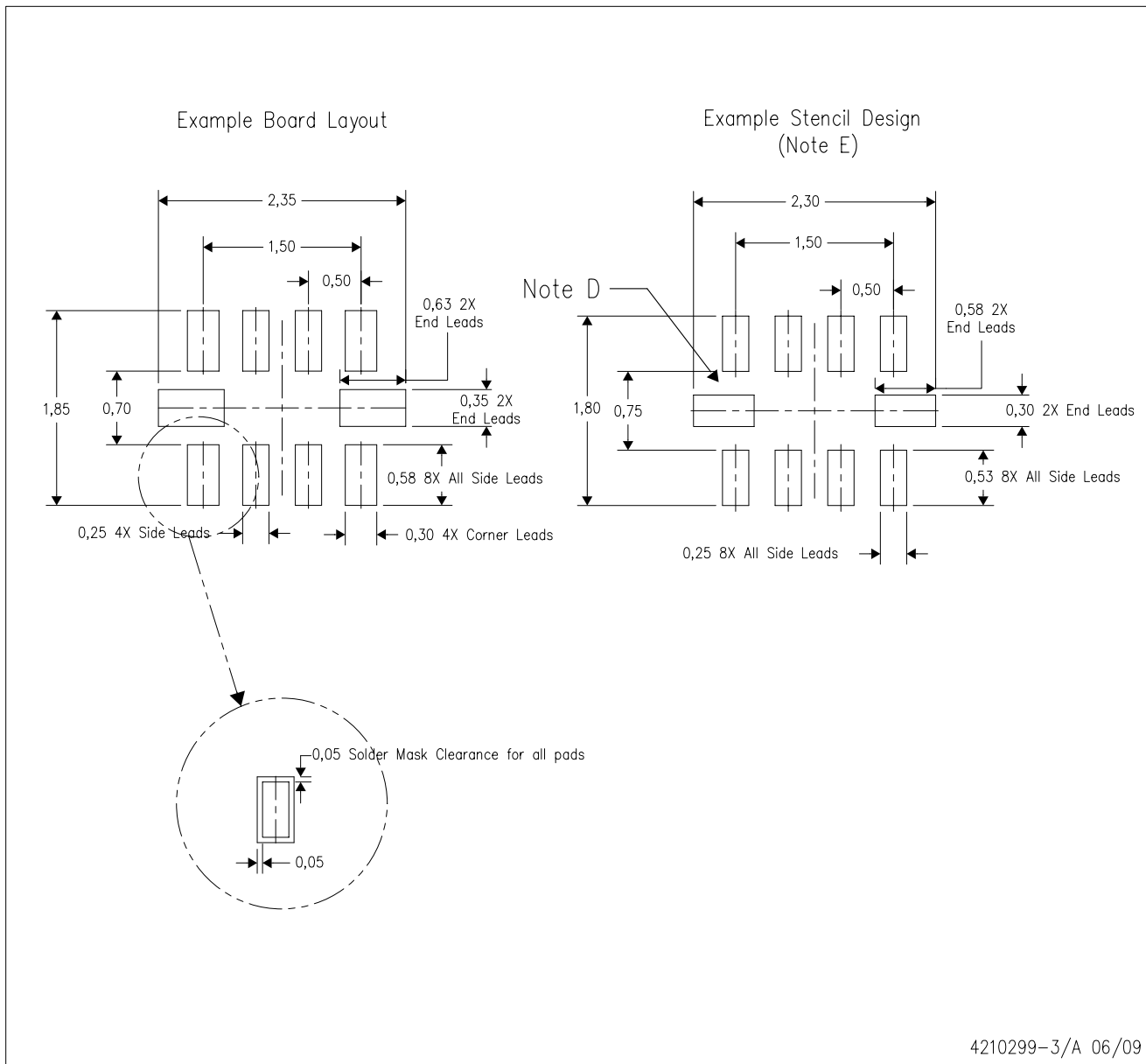
PLASTIC QUAD FLATPACK



4208528-3/B 04/2008

- NOTES:
- A. All linear dimensions are in millimeters. Dimensioning and tolerancing per ASME Y14.5M-1994.
  - B. This drawing is subject to change without notice.
  - C. QFN (Quad Flatpack No-Lead) package configuration.
  - D. This package complies to JEDEC MO-288 variation X2EFD.

RUG (R-PQFP-N10)



4210299-3/A 06/09

- NOTES:
- A. All linear dimensions are in millimeters.
  - B. This drawing is subject to change without notice.
  - C. Publication IPC-7351 is recommended for alternate designs.
  - D. Customers should contact their board fabrication site for minimum solder mask web tolerances between signal pads.
  - E. Maximum stencil thickness 0,127 mm (5 mils). All linear dimensions are in millimeters.
  - F. Laser cutting apertures with trapezoidal walls and also rounding corners will offer better paste release. Customers should contact their board assembly site for stencil design recommendations. Refer to IPC 7525 for stencil design considerations.
  - G. Side aperture dimensions over-print land for acceptable area ratio > 0.66. Customer may reduce side aperture dimensions if stencil manufacturing process allows for sufficient release at smaller opening.



D0008A

# PACKAGE OUTLINE

SOIC - 1.75 mm max height

SMALL OUTLINE INTEGRATED CIRCUIT



4214825/C 02/2019

NOTES:

1. Linear dimensions are in inches [millimeters]. Dimensions in parenthesis are for reference only. Controlling dimensions are in inches. Dimensioning and tolerancing per ASME Y14.5M.
2. This drawing is subject to change without notice.
3. This dimension does not include mold flash, protrusions, or gate burrs. Mold flash, protrusions, or gate burrs shall not exceed  $.006$  [0.15] per side.
4. This dimension does not include interlead flash.
5. Reference JEDEC registration MS-012, variation AA.

# EXAMPLE BOARD LAYOUT

D0008A

SOIC - 1.75 mm max height

SMALL OUTLINE INTEGRATED CIRCUIT



LAND PATTERN EXAMPLE  
EXPOSED METAL SHOWN  
SCALE:8X



SOLDER MASK DETAILS

4214825/C 02/2019

NOTES: (continued)

6. Publication IPC-7351 may have alternate designs.

7. Solder mask tolerances between and around signal pads can vary based on board fabrication site.

# EXAMPLE STENCIL DESIGN

D0008A

SOIC - 1.75 mm max height

SMALL OUTLINE INTEGRATED CIRCUIT



SOLDER PASTE EXAMPLE  
BASED ON .005 INCH [0.125 MM] THICK STENCIL  
SCALE:8X

4214825/C 02/2019

NOTES: (continued)

8. Laser cutting apertures with trapezoidal walls and rounded corners may offer better paste release. IPC-7525 may have alternate design recommendations.
9. Board assembly site may have different recommendations for stencil design.



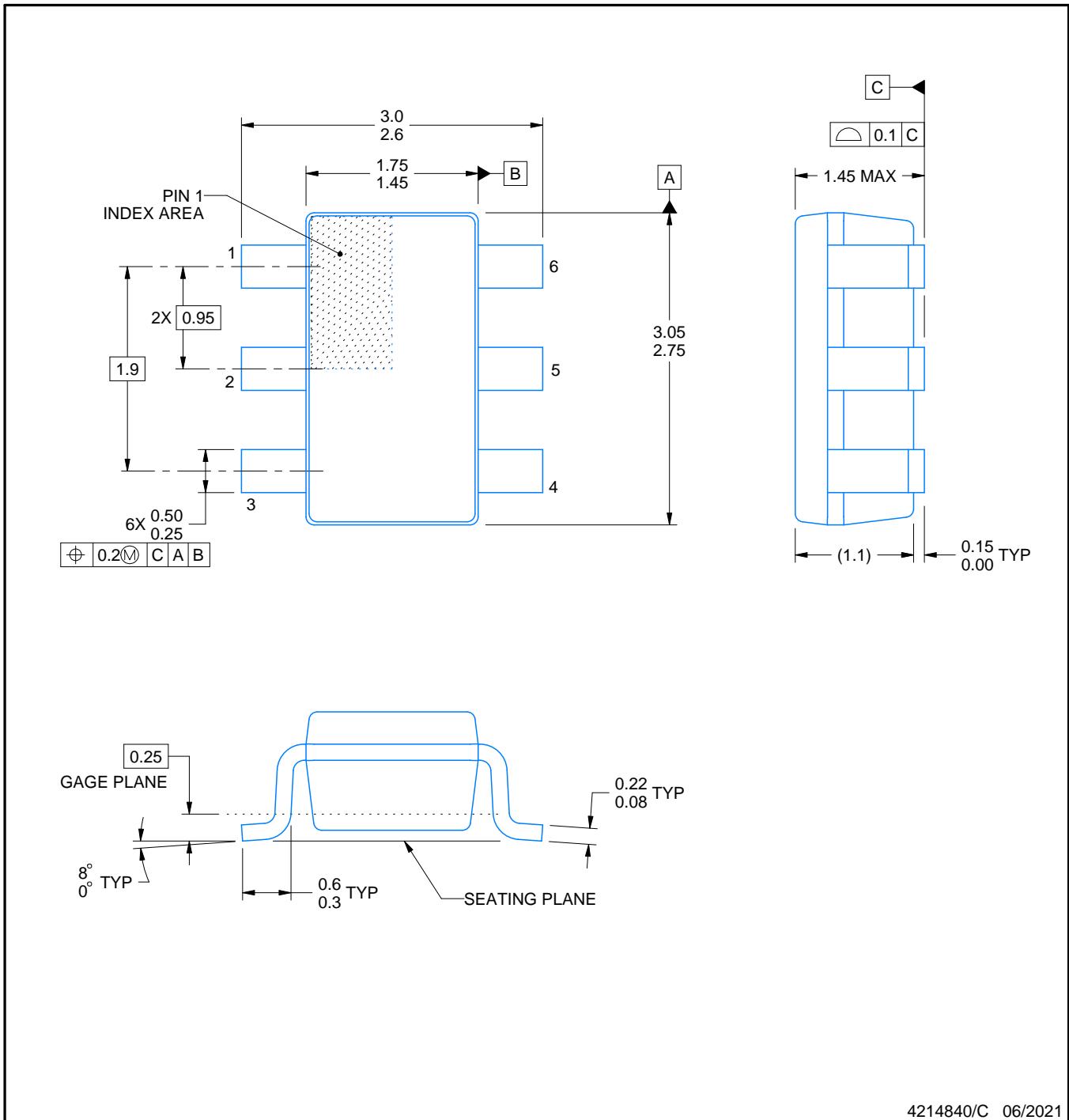
DBV0006A



# PACKAGE OUTLINE

SOT-23 - 1.45 mm max height

SMALL OUTLINE TRANSISTOR



4214840/C 06/2021

## NOTES:

1. All linear dimensions are in millimeters. Any dimensions in parenthesis are for reference only. Dimensioning and tolerancing per ASME Y14.5M.
2. This drawing is subject to change without notice.
3. Body dimensions do not include mold flash or protrusion. Mold flash and protrusion shall not exceed 0.25 per side.
4. Leads 1,2,3 may be wider than leads 4,5,6 for package orientation.
5. Reference JEDEC MO-178.

# EXAMPLE BOARD LAYOUT

DBV0006A

SOT-23 - 1.45 mm max height

SMALL OUTLINE TRANSISTOR



LAND PATTERN EXAMPLE  
EXPOSED METAL SHOWN  
SCALE:15X



SOLDER MASK DETAILS

4214840/C 06/2021

NOTES: (continued)

6. Publication IPC-7351 may have alternate designs.

7. Solder mask tolerances between and around signal pads can vary based on board fabrication site.

# EXAMPLE STENCIL DESIGN

DBV0006A

SOT-23 - 1.45 mm max height

SMALL OUTLINE TRANSISTOR



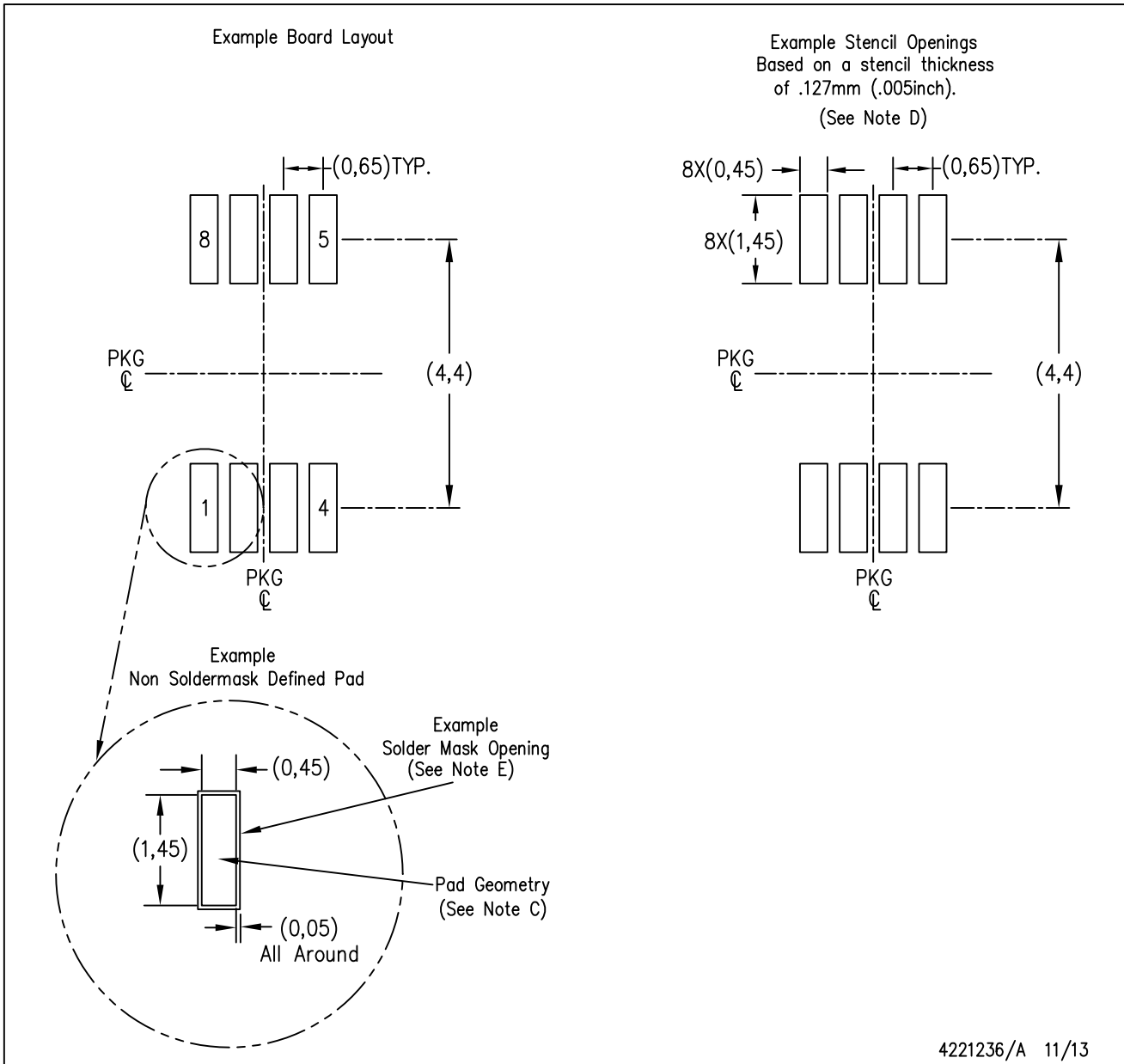
SOLDER PASTE EXAMPLE  
BASED ON 0.125 mm THICK STENCIL  
SCALE:15X

4214840/C 06/2021

NOTES: (continued)

8. Laser cutting apertures with trapezoidal walls and rounded corners may offer better paste release. IPC-7525 may have alternate design recommendations.
9. Board assembly site may have different recommendations for stencil design.





- NOTES:
- A. All linear dimensions are in millimeters.
  - B. This drawing is subject to change without notice.
  - C. Publication IPC-7351 is recommended for alternate designs.
  - D. Laser cutting apertures with trapezoidal walls and also rounding corners will offer better paste release. Customers should contact their board assembly site for stencil design recommendations. Refer to IPC-7525 for other stencil recommendations.
  - E. Customers should contact their board fabrication site for solder mask tolerances between and around signal pads.

## GENERIC PACKAGE VIEW

**DSG 8**

**WSON - 0.8 mm max height**

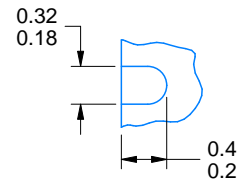
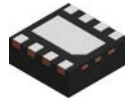
2 x 2, 0.5 mm pitch

PLASTIC SMALL OUTLINE - NO LEAD

This image is a representation of the package family, actual package may vary.  
Refer to the product data sheet for package details.



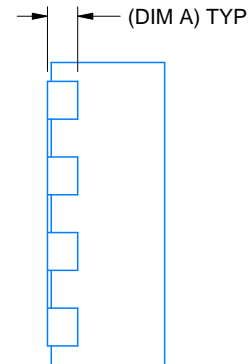
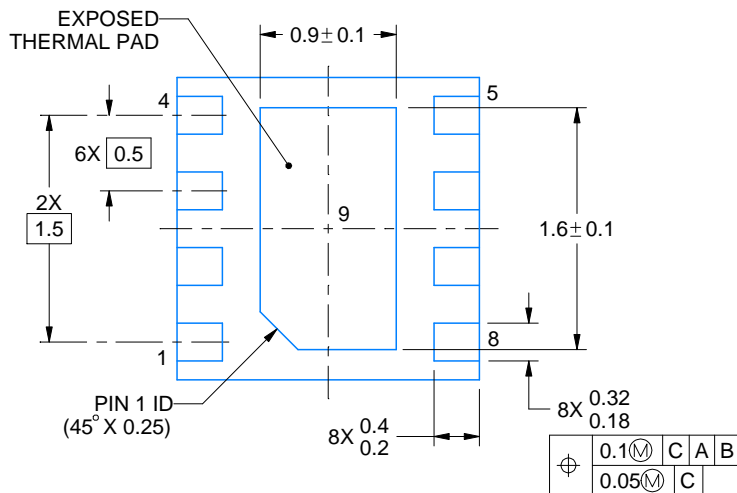
4224783/A



ALTERNATIVE TERMINAL SHAPE TYPICAL



SIDE WALL METAL THICKNESS DIM A	
OPTION 1	OPTION 2
0.1	0.2



4218900/E 08/2022

NOTES:

1. All linear dimensions are in millimeters. Any dimensions in parenthesis are for reference only. Dimensioning and tolerancing per ASME Y14.5M.
2. This drawing is subject to change without notice.
3. The package thermal pad must be soldered to the printed circuit board for thermal and mechanical performance.

# EXAMPLE BOARD LAYOUT

DSG0008A

WSON - 0.8 mm max height

PLASTIC SMALL OUTLINE - NO LEAD



LAND PATTERN EXAMPLE  
SCALE:20X



SOLDER MASK DETAILS

4218900/E 08/2022

NOTES: (continued)

4. This package is designed to be soldered to a thermal pad on the board. For more information, see Texas Instruments literature number SLUA271 ([www.ti.com/lit/slua271](http://www.ti.com/lit/slua271)).
5. Vias are optional depending on application, refer to device data sheet. If any vias are implemented, refer to their locations shown on this view. It is recommended that vias under paste be filled, plugged or tented.



# EXAMPLE STENCIL DESIGN

DSG0008A

WSON - 0.8 mm max height

PLASTIC SMALL OUTLINE - NO LEAD



SOLDER PASTE EXAMPLE  
BASED ON 0.125 mm THICK STENCIL

EXPOSED PAD 9:  
87% PRINTED SOLDER COVERAGE BY AREA UNDER PACKAGE  
SCALE:25X

4218900/E 08/2022

NOTES: (continued)

6. Laser cutting apertures with trapezoidal walls and rounded corners may offer better paste release. IPC-7525 may have alternate design recommendations.

PW0008A



# PACKAGE OUTLINE

## TSSOP - 1.2 mm max height

SMALL OUTLINE PACKAGE



4221848/A 02/2015

NOTES:

1. All linear dimensions are in millimeters. Any dimensions in parenthesis are for reference only. Dimensioning and tolerancing per ASME Y14.5M.
2. This drawing is subject to change without notice.
3. This dimension does not include mold flash, protrusions, or gate burrs. Mold flash, protrusions, or gate burrs shall not exceed 0.15 mm per side.
4. This dimension does not include interlead flash. Interlead flash shall not exceed 0.25 mm per side.
5. Reference JEDEC registration MO-153, variation AA.

# EXAMPLE BOARD LAYOUT

PW0008A

TSSOP - 1.2 mm max height

SMALL OUTLINE PACKAGE



LAND PATTERN EXAMPLE  
SCALE:10X



SOLDER MASK DETAILS  
NOT TO SCALE

4221848/A 02/2015

NOTES: (continued)

- 6. Publication IPC-7351 may have alternate designs.
- 7. Solder mask tolerances between and around signal pads can vary based on board fabrication site.

# EXAMPLE STENCIL DESIGN

PW0008A

TSSOP - 1.2 mm max height

SMALL OUTLINE PACKAGE



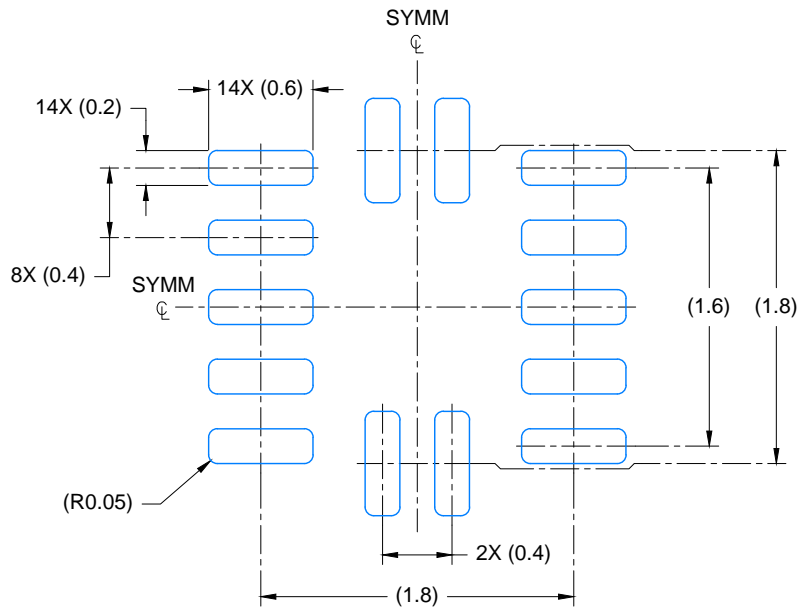
SOLDER PASTE EXAMPLE  
BASED ON 0.125 mm THICK STENCIL  
SCALE:10X

4221848/A 02/2015

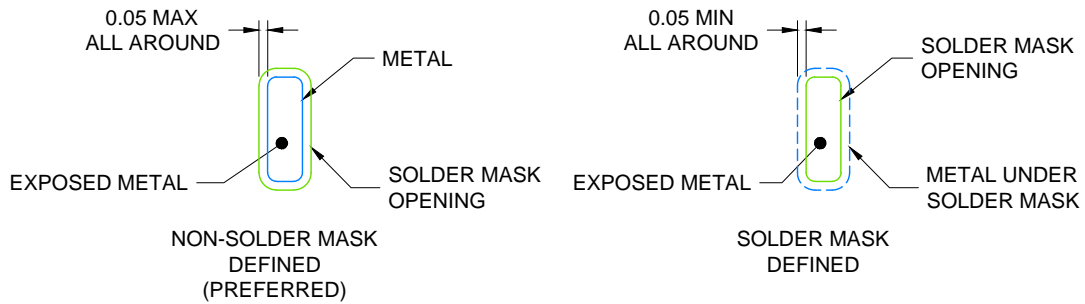
NOTES: (continued)

8. Laser cutting apertures with trapezoidal walls and rounded corners may offer better paste release. IPC-7525 may have alternate design recommendations.
9. Board assembly site may have different recommendations for stencil design.





LAND PATTERN EXAMPLE  
EXPOSED METAL SHOWN  
SCALE: 23X



SOLDER MASK DETAILS

4220584/A 05/2019

NOTES: (continued)

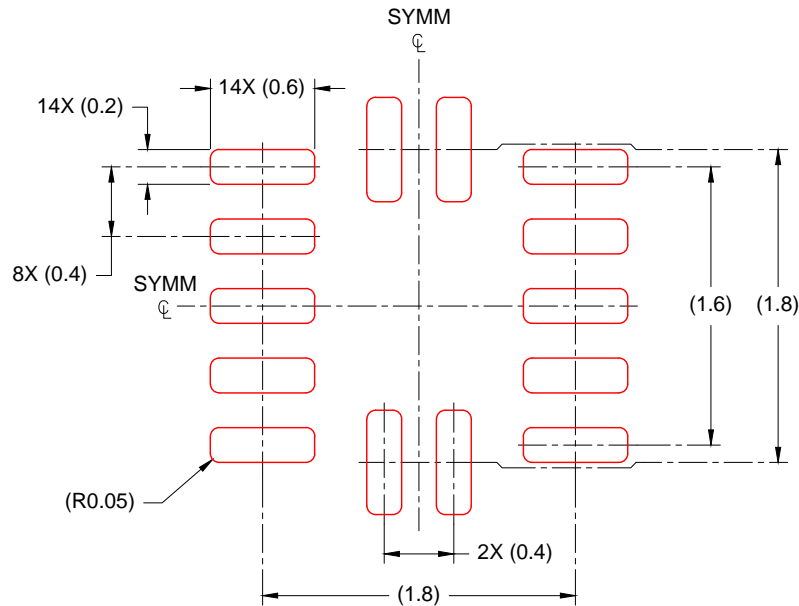
- For more information, see Texas Instruments literature number SLUA271 ([www.ti.com/lit/slua271](http://www.ti.com/lit/slua271)).

# EXAMPLE STENCIL DESIGN

RUC0014A

X2QFN - 0.4 mm max height

PLASTIC QUAD FLAT PACK- NO LEAD



SOLDER PASTE EXAMPLE  
BASED ON 0.100mm THICK STENCIL  
SCALE: 23X

4220584/A 05/2019

NOTES: (continued)

4. Laser cutting apertures with trapezoidal walls and rounded corners may offer better paste release. IPC-7525 may have alternate design recommendations.

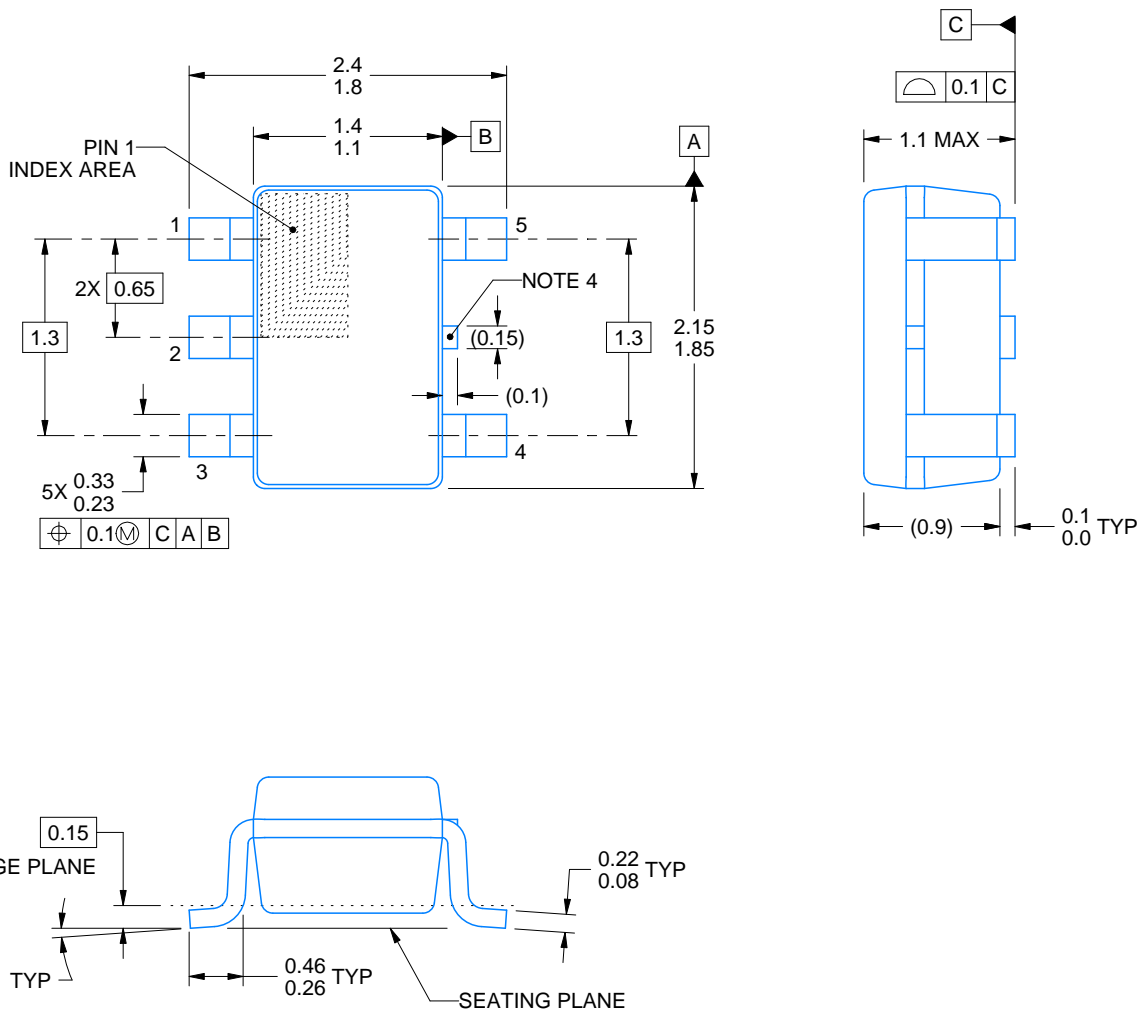
DCK0005A



# PACKAGE OUTLINE

SOT - 1.1 max height

SMALL OUTLINE TRANSISTOR



4214834/C 03/2023

## NOTES:

1. All linear dimensions are in millimeters. Any dimensions in parenthesis are for reference only. Dimensioning and tolerancing per ASME Y14.5M.
2. This drawing is subject to change without notice.
3. Reference JEDEC MO-203.
4. Support pin may differ or may not be present.

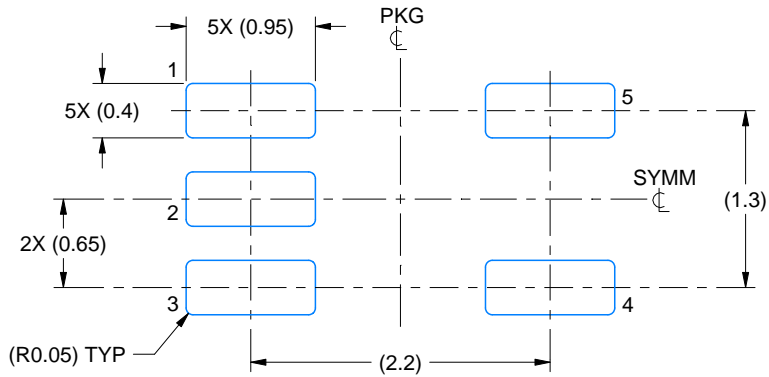


# EXAMPLE BOARD LAYOUT

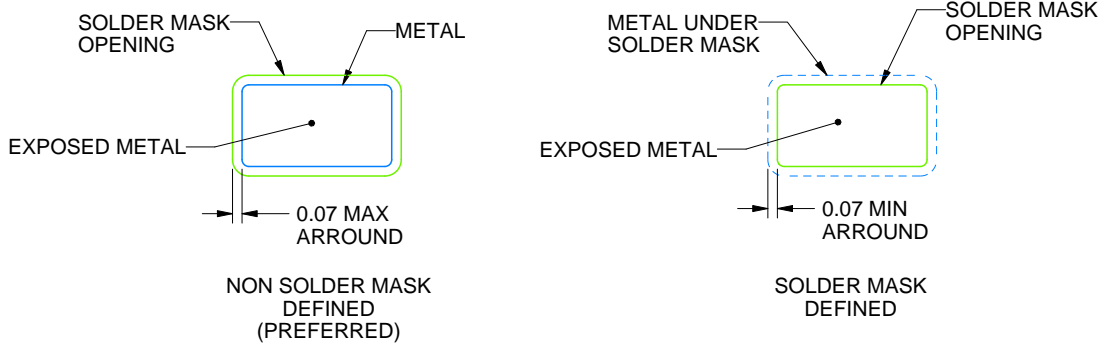
DCK0005A

SOT - 1.1 max height

SMALL OUTLINE TRANSISTOR



LAND PATTERN EXAMPLE  
EXPOSED METAL SHOWN  
SCALE:18X



SOLDER MASK DETAILS

4214834/C 03/2023

NOTES: (continued)

- 4. Publication IPC-7351 may have alternate designs.
- 5. Solder mask tolerances between and around signal pads can vary based on board fabrication site.

# EXAMPLE STENCIL DESIGN

DCK0005A

SOT - 1.1 max height

SMALL OUTLINE TRANSISTOR



SOLDER PASTE EXAMPLE  
BASED ON 0.125 THICK STENCIL  
SCALE:18X

4214834/C 03/2023

NOTES: (continued)

6. Laser cutting apertures with trapezoidal walls and rounded corners may offer better paste release. IPC-7525 may have alternate design recommendations.
7. Board assembly site may have different recommendations for stencil design.

# DDF0008A



# PACKAGE OUTLINE

## SOT-23 - 1.1 mm max height

PLASTIC SMALL OUTLINE



4222047/C 10/2022

### NOTES:

- All linear dimensions are in millimeters. Any dimensions in parenthesis are for reference only. Dimensioning and tolerancing per ASME Y14.5M.
- This drawing is subject to change without notice.
- This dimension does not include mold flash, protrusions, or gate burrs. Mold flash, protrusions, or gate burrs shall not exceed 0.15 mm per side.

# EXAMPLE BOARD LAYOUT

DDF0008A

SOT-23 - 1.1 mm max height

PLASTIC SMALL OUTLINE



LAND PATTERN EXAMPLE  
SCALE:15X



NON SOLDER MASK  
DEFINED



SOLDER MASK  
DEFINED

## SOLDER MASK DETAILS

4222047/C 10/2022

NOTES: (continued)

4. Publication IPC-7351 may have alternate designs.
5. Solder mask tolerances between and around signal pads can vary based on board fabrication site.

# EXAMPLE STENCIL DESIGN

DDF0008A

SOT-23 - 1.1 mm max height

PLASTIC SMALL OUTLINE



SOLDER PASTE EXAMPLE  
BASED ON 0.125 mm THICK STENCIL  
SCALE:15X

4222047/C 10/2022

NOTES: (continued)

6. Laser cutting apertures with trapezoidal walls and rounded corners may offer better paste release. IPC-7525 may have alternate design recommendations.
7. Board assembly site may have different recommendations for stencil design.

## GENERIC PACKAGE VIEW

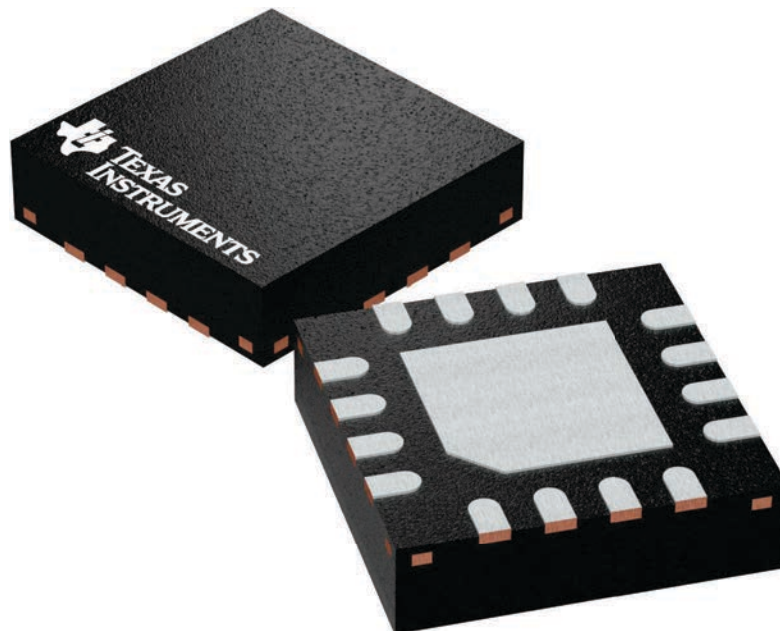
**RTE 16**

**WQFN - 0.8 mm max height**

3 x 3, 0.5 mm pitch

PLASTIC QUAD FLATPACK - NO LEAD

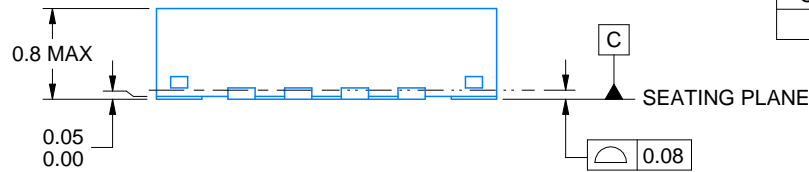
This image is a representation of the package family, actual package may vary.  
Refer to the product data sheet for package details.



4225944/A



SIDE WALL METAL THICKNESS DIM A	
OPTION 1	OPTION 2
0.1	0.2



4219117/B 04/2022

NOTES:

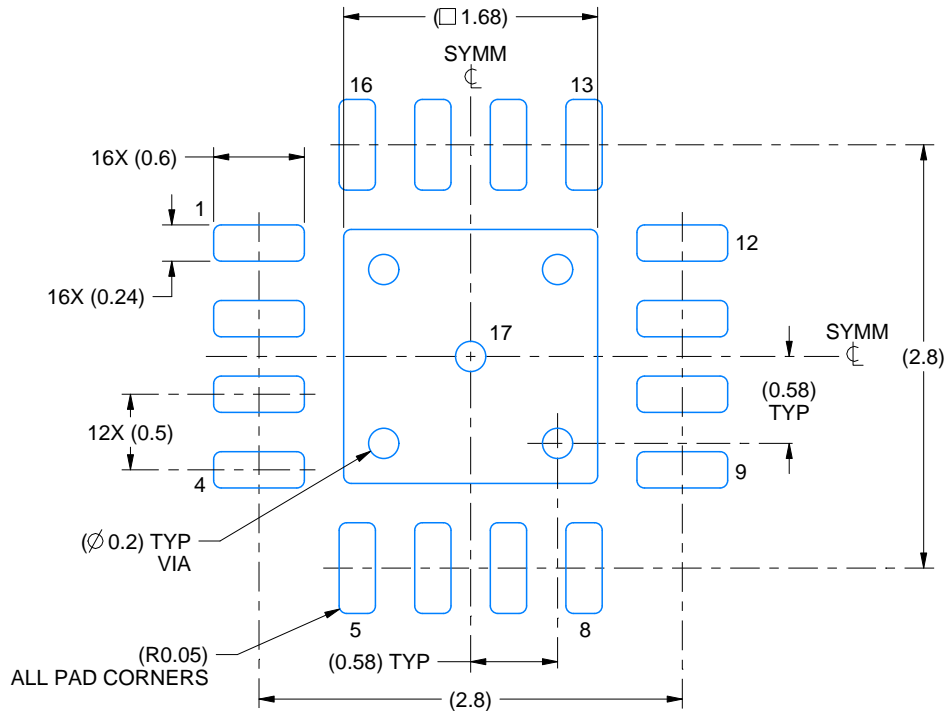
1. All linear dimensions are in millimeters. Any dimensions in parenthesis are for reference only. Dimensioning and tolerancing per ASME Y14.5M.
2. This drawing is subject to change without notice.
3. The package thermal pad must be soldered to the printed circuit board for thermal and mechanical performance.

# EXAMPLE BOARD LAYOUT

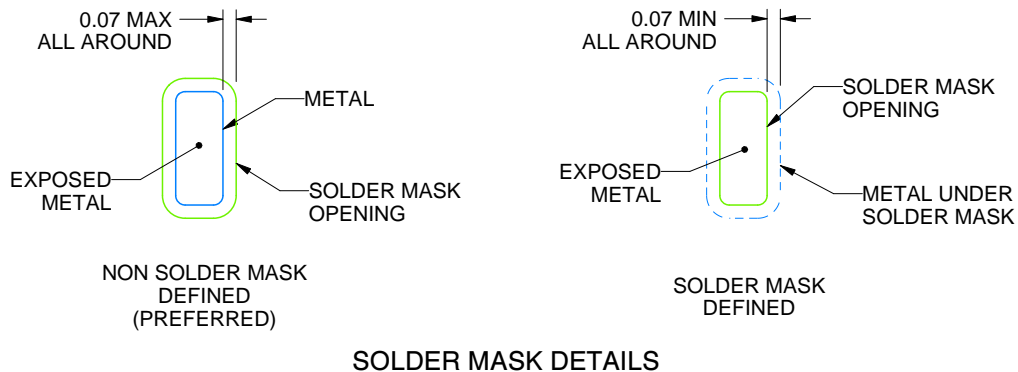
RTE0016C

WQFN - 0.8 mm max height

PLASTIC QUAD FLATPACK - NO LEAD



LAND PATTERN EXAMPLE  
EXPOSED METAL SHOWN  
SCALE:20X



SOLDER MASK DETAILS

4219117/B 04/2022

NOTES: (continued)

- This package is designed to be soldered to a thermal pad on the board. For more information, see Texas Instruments literature number SLUA271 ([www.ti.com/lit/slua271](http://www.ti.com/lit/slua271)).
- Vias are optional depending on application, refer to device data sheet. If any vias are implemented, refer to their locations shown on this view. It is recommended that vias under paste be filled, plugged or tented.



# EXAMPLE STENCIL DESIGN

RTE0016C

WQFN - 0.8 mm max height

PLASTIC QUAD FLATPACK - NO LEAD



**SOLDER PASTE EXAMPLE**  
BASED ON 0.125 mm THICK STENCIL

EXPOSED PAD 17:  
85% PRINTED SOLDER COVERAGE BY AREA UNDER PACKAGE  
SCALE:25X

4219117/B 04/2022

NOTES: (continued)

6. Laser cutting apertures with trapezoidal walls and rounded corners may offer better paste release. IPC-7525 may have alternate design recommendations.

## IMPORTANT NOTICE AND DISCLAIMER

TI PROVIDES TECHNICAL AND RELIABILITY DATA (INCLUDING DATA SHEETS), DESIGN RESOURCES (INCLUDING REFERENCE DESIGNS), APPLICATION OR OTHER DESIGN ADVICE, WEB TOOLS, SAFETY INFORMATION, AND OTHER RESOURCES "AS IS" AND WITH ALL FAULTS, AND DISCLAIMS ALL WARRANTIES, EXPRESS AND IMPLIED, INCLUDING WITHOUT LIMITATION ANY IMPLIED WARRANTIES OF MERCHANTABILITY, FITNESS FOR A PARTICULAR PURPOSE OR NON-INFRINGEMENT OF THIRD PARTY INTELLECTUAL PROPERTY RIGHTS.

These resources are intended for skilled developers designing with TI products. You are solely responsible for (1) selecting the appropriate TI products for your application, (2) designing, validating and testing your application, and (3) ensuring your application meets applicable standards, and any other safety, security, regulatory or other requirements.

These resources are subject to change without notice. TI grants you permission to use these resources only for development of an application that uses the TI products described in the resource. Other reproduction and display of these resources is prohibited. No license is granted to any other TI intellectual property right or to any third party intellectual property right. TI disclaims responsibility for, and you will fully indemnify TI and its representatives against, any claims, damages, costs, losses, and liabilities arising out of your use of these resources.

TI's products are provided subject to [TI's Terms of Sale](#) or other applicable terms available either on [ti.com](https://www.ti.com) or provided in conjunction with such TI products. TI's provision of these resources does not expand or otherwise alter TI's applicable warranties or warranty disclaimers for TI products.

TI objects to and rejects any additional or different terms you may have proposed.

Mailing Address: Texas Instruments, Post Office Box 655303, Dallas, Texas 75265  
Copyright © 2023, Texas Instruments Incorporated