

# Low Power, Low Dropout, 500mA RF Linear Regulators

## 1 FEATURES

- Low Output Noise
- Low Dropout Voltage
- Thermal-Overload Protection
- Output Current Limit
- 10nA Logic-Controlled Shutdown
- 30 $\mu$ A(TYP) Low Supply Current
- 1.7V to 7.5V Input Voltage Range
- 500mA Output Current
- -40°C to +85°C Operating Temperature Range
- Available in Green UTDFN-1x1-4, SOT23-5, SOT23-3, SOT353(SC70-5) and SOT89-3L (L-Type) Package

## 2 APPLICATIONS

- Cellular Telephones
- Camera Modules
- Modems
- HiFi Audio Radio Transceivers
- PLL/Synthesizer, Clocking
- Medium-Current, Noise-Sensitive Applications

## 3 DESCRIPTIONS

The RS3236 series low-power, low-dropout, CMOS LDO operate from 1.7V to 7.5V input voltage that can supply up to 500mA of output current. Designed to meet the requirements of RF and analog circuits, the RS3236 series device provides low noise, high PSRR, low quiescent current, and low line and load transient response.

The device is designed to work with a 1- $\mu$ F input and a 1- $\mu$ F output ceramic capacitor (no separate noise bypass capacitor required). An external noise bypass capacitor connected to the device's BP pin can further reduce the noise level.

Other features include a 10nA logic-controlled shutdown mode, foldback current limit and thermal shutdown protection.

The RS3236 series is available in Green UTDFN-1x1-4, SOT23-3, SOT23-5, SOT353(SC70-5) and SOT89-3L(L-Type) package. It operates over an ambient temperature range of -40°C to +85°C.

## 4 Functional Block Diagram

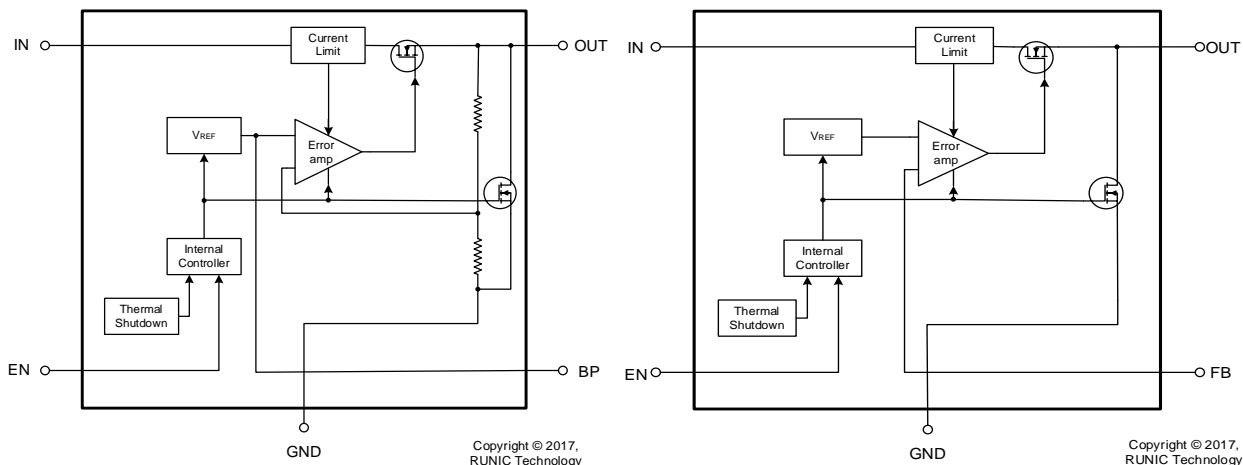

---

## Table of Contents

<b>1 FEATURES</b> .....	1
<b>2 APPLICATIONS</b> .....	1
<b>3 DESCRIPTIONS</b> .....	1
<b>4 Functional Block Diagram</b> .....	1
<b>5 Revision History</b> .....	3
<b>6 Pin Configuration and Functions (Top View)</b> .....	4
<b>7 PACKAGE/ORDERING INFORMATION</b> .....	6
<b>8 Absolute Maximum Ratings</b> .....	9
8.1 ESD Ratings.....	9
8.2 Recommended Operating Conditions.....	9
8.3 Thermal Information .....	10
8.4 ELECTRICAL CHARACTERISTICS.....	11
8.5 TYPICAL APPLICATION CIRCUIT .....	13
8.6 TYPICAL PERFORMANCE CHARACTERISTICS.....	14
<b>9 PACKAGE OUTLINE DIMENSIONS</b> .....	16
<b>10 TAPE AND REEL INFORMATION</b> .....	21

## 5 Revision History

Note: Page numbers for previous revisions may differ from page numbers in the current version.

VERSION	Change Date	Change Item
A.1	2017/06/01	Initial version completed
A.2	2018/01/05	1) Added output voltage 2) Added SOT89-3 (L) package
C.1	2019/11/12	1) Added output voltage 2) Raise the over temperature protection temperature
C.2	2020/08/23	1) Added output voltage model 2) Optimize noise index
C.3	2022/09/09	1) Added the TAPE AND REEL INFORMATION 2) Modify NC DESCRIPTION on Page 3@RevC.2
C.4	2022/09/13	Modify Load Regulation PARAMETER

## 6 Pin Configuration and Functions (Top View)

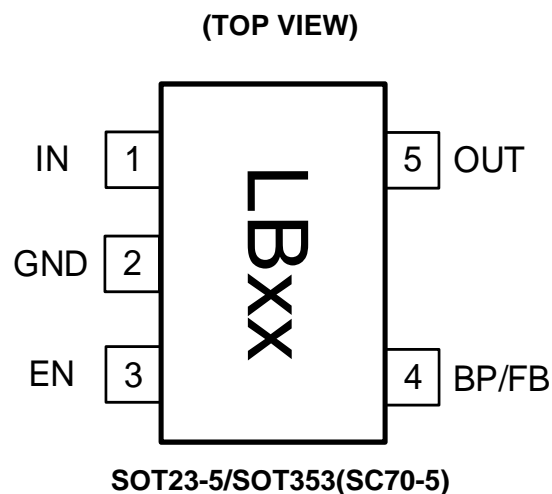
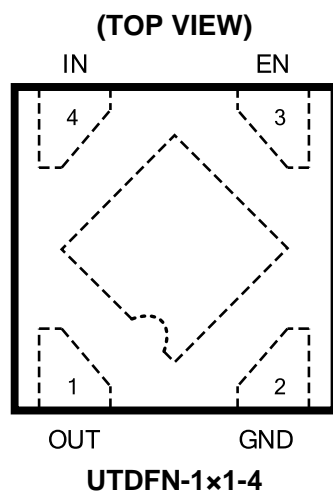

UTDNFN-1x1-4		I/O <sup>(1)</sup>	DESCRIPTION
NUMBER	NAME		
1	OUT	O	Regulator Output.
2	GND	G	Ground.
3	EN	I	Enable Input. A logic low reduces the supply current to 10nA. Connect to IN for normal operation.
4	IN	I	Regulator Input. Supply voltage can range from 1.7V to 7.5V. Bypass with a 1 $\mu$ F capacitor to GND.
Thermal Pad	-	-	Connect the thermal pad to a large-area ground plane. This pad is not an electrical connection to the device ground.

(1) I = Input, O = Output, P = Power, G=Ground.

SOT23-5 /SOT353(SC70-5)		I/O <sup>(1)</sup>	DESCRIPTION
NUMBER	NAME		
1	IN	I	Regulator Input. Supply voltage can range from 1.7V to 7.5V. Bypass with a 1 $\mu$ F capacitor to GND.
2	GND	G	Ground.
3	EN	I	Enable Input. A logic low reduces the supply current to 10nA. Connect to IN for normal operation.
4	BP/NC	O	For internal use, floating and do not connect any pins (fixed voltage version only).
	FB		Feedback Pin (adjustable voltage version only). This is used to set the output voltage of the device.
5	OUT	O	Regulator Output.

(1) I = Input, O = Output, P = Power, G=Ground.

### Pin Configuration and Functions (Top View)

TOP VIEW

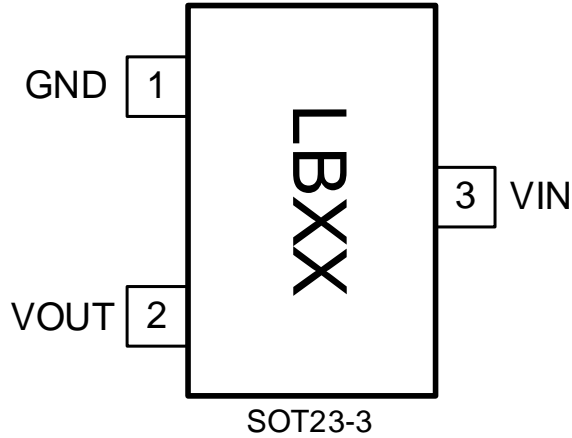

NOTE:XX indicate Output Voltage,xx indicate DataCode  
For example:LB33(VOUT=3.3V)

SOT23-3		I/O <sup>(1)</sup>	DESCRIPTION
NUMBER	NAME		
1	GND	G	Ground.
2	OUT	O	Regulator Output.
3	IN	I	Regulator Input. Supply voltage can range from 1.7V to 7.5V. Bypass with a 1μF capacitor to GND.

(1) I = Input, O = Output, P = Power, G=Ground.

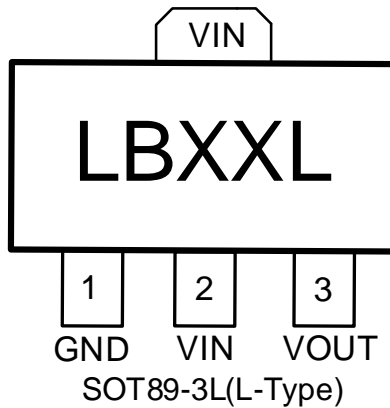

SOT89-3L(L-Type)		I/O <sup>(1)</sup>	DESCRIPTION
NUMBER	NAME		
1	GND	G	Ground.
2	IN	I	Regulator Input. Supply voltage can range from 1.7V to 7.5V. Bypass with a 1μF capacitor to GND.
3	OUT	O	Regulator Output.

(1) I = Input, O = Output, P = Power, G=Ground.

**7 PACKAGE/ORDERING INFORMATION**

PRODUCT	ORDERING NUMBER <sup>(2)</sup>	V <sub>OUT</sub> (V)	V <sub>OUT</sub> Accuracy	PACKAGE LEAD	PACKAGE MARKING <sup>(1)</sup>	PACKAGE OPTION
RS3236-0.75	RS3236-0.75YUTDN4	0.75V	±2.5%	UTDFN-1x1-4	BA	Tape and Reel,10000
	RS3236-0.75YF5	0.75V	±2.5%	SOT23-5	LB075	Tape and Reel,3000
	RS3236-0.75YC5	0.75V	±2.5%	SOT353(SC70-5)	LB075	Tape and Reel,3000
	RS3236-0.75YF3	0.75V	±2.5%	SOT23-3	LB075	Tape and Reel,3000
RS3236-1.0	RS3236-1.0YUTDN4	1.0V	±2.5%	UTDFN-1x1-4	BB	Tape and Reel,10000
	RS3236-1.0YF5	1.0V	±2.5%	SOT23-5	LB10	Tape and Reel,3000
	RS3236-1.0YC5	1.0V	±2.5%	SOT353(SC70-5)	LB10	Tape and Reel,3000
	RS3236-1.0YF3	1.0V	±2.5%	SOT23-3	LB10	Tape and Reel,3000
RS3236-1.2	RS3236-1.2YUTDN4	1.2V	±2.5%	UTDFN-1x1-4	BC	Tape and Reel,10000
	RS3236-1.2YF5	1.2V	±2.5%	SOT23-5	LB12	Tape and Reel,3000
	RS3236-1.2YC5	1.2V	±2.5%	SOT353(SC70-5)	LB12	Tape and Reel,3000
	RS3236-1.2YF3	1.2V	±2.5%	SOT23-3	LB12	Tape and Reel,3000
RS3236-1.5	RS3236-1.5YUTDN4	1.5V	±2.5%	UTDFN-1x1-4	BD	Tape and Reel,10000
	RS3236-1.5YF5	1.5V	±2.5%	SOT23-5	LB15	Tape and Reel,3000
	RS3236-1.5YC5	1.5V	±2.5%	SOT353(SC70-5)	LB15	Tape and Reel,3000
	RS3236-1.5YF3	1.5V	±2.5%	SOT23-3	LB15	Tape and Reel,3000
RS3236-1.8	RS3236-1.8YUTDN4	1.8V	±2.5%	UTDFN-1x1-4	BE	Tape and Reel,10000
	RS3236-1.8YF5	1.8V	±2.5%	SOT23-5	LB18	Tape and Reel,3000
	RS3236-1.8YC5	1.8V	±2.5%	SOT353(SC70-5)	LB18	Tape and Reel,3000
	RS3236-1.8YF3	1.8V	±2.5%	SOT23-3	LB18	Tape and Reel,3000
	RS3236-1.8YE3L	1.8V	±2.5%	SOT89-3L(L-Type)	LB18L	Tape and Reel,1000
RS3236-2.05	RS3236-2.05YUTDN4	2.05V	±2.5%	UTDFN-1x1-4	BF	Tape and Reel,10000
	RS3236-2.05YF5	2.05V	±2.5%	SOT23-5	LB205	Tape and Reel,3000
	RS3236-2.05YC5	2.05V	±2.5%	SOT353(SC70-5)	LB205	Tape and Reel,3000
	RS3236-2.05YF3	2.05V	±2.5%	SOT23-3	LB205	Tape and Reel,3000
RS3236-2.5	RS3236-2.5YUTDN4	2.5V	±2.5%	UTDFN-1x1-4	BG	Tape and Reel,10000
	RS3236-2.5YF5	2.5V	±2.5%	SOT23-5	LB25	Tape and Reel,3000
	RS3236-2.5YC5	2.5V	±2.5%	SOT353(SC70-5)	LB25	Tape and Reel,3000
	RS3236-2.5YF3	2.5V	±2.5%	SOT23-3	LB25	Tape and Reel,3000
RS3236-2.8	RS3236-2.8YUTDN4	2.8V	±2.5%	UTDFN-1x1-4	BH	Tape and Reel,10000
	RS3236-2.8YF5	2.8V	±2.5%	SOT23-5	LB28	Tape and Reel,3000

	RS3236-2.8YC5	2.8V	±2.5%	SOT353(SC70-5)	LB28	Tape and Reel,3000
	RS3236-2.8YF3	2.8V	±2.5%	SOT23-3	LB28	Tape and Reel,3000
RS3236-3.0	RS3236-3.0YUTDN4	3.0V	±2.5%	UTDFN-1x1-4	BI	Tape and Reel,10000
	RS3236-3.0YF5	3.0V	±2.5%	SOT23-5	LB30	Tape and Reel,3000
	RS3236-3.0YC5	3.0V	±2.5%	SOT353(SC70-5)	LB30	Tape and Reel,3000
	RS3236-3.0YF3	3.0V	±2.5%	SOT23-3	LB30	Tape and Reel,3000
RS3236-3.3	RS3236-3.3YUTDN4	3.3V	±2.5%	UTDFN-1x1-4	BJ	Tape and Reel,10000
	RS3236-3.3YF5	3.3V	±2.5%	SOT23-5	LB33	Tape and Reel,3000
	RS3236-3.3YC5	3.3V	±2.5%	SOT353(SC70-5)	LB33	Tape and Reel,3000
	RS3236-3.3YF3	3.3V	±2.5%	SOT23-3	LB33	Tape and Reel,3000
	RS3236-3.3YE3L	3.3V	±2.5%	SOT89-3L(L-Type)	LB33L	Tape and Reel,1000
RS3236-3.6	RS3236-3.6YUTDN4	3.6V	±2.5%	UTDFN-1x1-4	BK	Tape and Reel,10000
	RS3236-3.6YF5	3.6V	±2.5%	SOT23-5	LB36	Tape and Reel,3000
	RS3236-3.6YC5	3.6V	±2.5%	SOT353(SC70-5)	LB36	Tape and Reel,3000
	RS3236-3.6YF3	3.6V	±2.5%	SOT23-3	LB36	Tape and Reel,3000
RS3236-4.0	RS3236-4.0YUTDN4	4.0V	±2.5%	UTDFN-1x1-4	BL	Tape and Reel,10000
	RS3236-4.0YF5	4.0V	±2.5%	SOT23-5	LB40	Tape and Reel,3000
	RS3236-4.0YC5	4.0V	±2.5%	SOT353(SC70-5)	LB40	Tape and Reel,3000
	RS3236-4.0YF3	4.0V	±2.5%	SOT23-3	LB40	Tape and Reel,3000
	RS3236-4.0YE3L	4.0V	±2.5%	SOT89-3L(L-Type)	LB40L	Tape and Reel,1000
RS3236-5.0	RS3236-5.0YUTDN4	5.0V	±2.5%	UTDFN-1x1-4	BM	Tape and Reel,10000
	RS3236-5.0YF5	5.0V	±2.5%	SOT23-5	LB50	Tape and Reel,3000
	RS3236-5.0YC5	5.0V	±2.5%	SOT353(SC70-5)	LB50	Tape and Reel,3000
	RS3236-5.0YF3	5.0V	±2.5%	SOT23-3	LB50	Tape and Reel,3000
RS3236-1.35	RS3236-1.35YUTDN4	1.35V	±2.5%	UTDFN-1x1-4	BN	Tape and Reel,10000
RS3236-1.85	RS3236-1.85YUTDN4	1.85V	±2.5%	UTDFN-1x1-4	BO	Tape and Reel,10000
RS3236-2.7	RS3236-2.7YF5	2.7V	±2.5%	SOT23-5	LB27	Tape and Reel,3000
RS3236-2.1	RS3236-2.1YF5	2.1V	±2.5%	SOT23-5	LB21	Tape and Reel,3000
RS3236-2.85	RS3236-2.85YF5	2.85V	±2.5%	SOT23-5	LB285	Tape and Reel,3000

PRODUCT	ORDERING NUMBER (2)	V <sub>OUT</sub> (V)	V <sub>OUT</sub> Accuracy	PACKAGE LEAD	PACKAGE MARKING (1)	PACKAGE OPTION
RS3236-3.3	RS3236-3.3AYUTDN4	3.3V	±1%	UTDFN-1x1-4	BJ	Tape and Reel,10000
RS3236-3.3	RS3236-3.3AYF5	3.3V	±1%	SOT23-5	LB33A	Tape and Reel, 3000
RS3236-5.0	RS3236-5.0AYF5	5.0V	±1%	SOT23-5	LB50A	Tape and Reel, 3000

MODEL	V <sub>FB</sub> (V)	PIN-PACKAGE	ORDERING NUMBER	PACKAGE MARKING (1)	PACKAGE OPTION
RS3236-ADJ8	0.81	SOT23-5	RS3236-ADJ8YF5	LBAD8	Tape and Reel, 3000
		SOT353(SC70-5)	RS3236-ADJ8YC5	LBAD8	Tape and Reel, 3000
RS3236-ADJC	1.21	SOT23-5	RS3236-ADJCYF5	LBADC	Tape and Reel, 3000
		SOT353(SC70-5)	RS3236-ADJCYC5	LBADC	Tape and Reel, 3000

NOTE:

(1) There may be additional marking, which relates to the lot trace code information(include data code and vendor code), the logo or the environmental category on the device.

(2) RS3236-□□□□

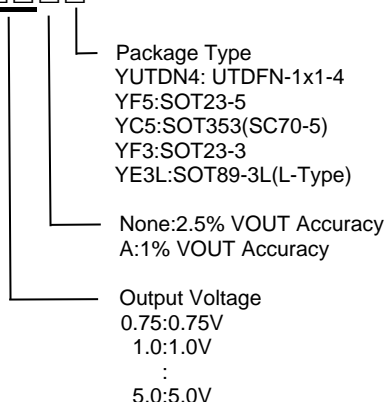



## 8 Absolute Maximum Ratings

over operating free-air temperature range (unless otherwise noted) <sup>(1)(2)</sup>

		MIN	MAX	UNIT
V <sub>IN</sub>	Input voltage	-0.3	8	V
V <sub>EN</sub>	Enable input voltage	-0.3	V <sub>IN</sub>	V
T <sub>J</sub>	Junction temperature <sup>(4)</sup>	-40	150	°C
P <sub>D</sub>	Continuous power dissipation <sup>(3)</sup>	Internally Limited		W
T <sub>stg</sub>	Storage temperature	-65	150	°C

- (1) Stresses beyond those listed under *Absolute Maximum Ratings* may cause permanent damage to the device. These are stress ratings only, and functional operation of the device at these or any other conditions beyond those indicated under *Recommended Operating Conditions* is not implied. Exposure to absolute-maximum-rated conditions for extended periods may affect device reliability.
- (2) All voltages are with respect to the GND pin.
- (3) Internal thermal shutdown circuitry protects the device from permanent damage.
- (4) The maximum power dissipation is a function of T<sub>J(MAX)</sub>, R<sub>θJA</sub>, and T<sub>A</sub>. The maximum allowable power dissipation at any ambient temperature is P<sub>D</sub> = (T<sub>J(MAX)</sub> - T<sub>A</sub>) / R<sub>θJA</sub>. All numbers apply for packages soldered directly onto a PCB.

### 8.1 ESD Ratings

The following ESD information is provided for handling of ESD-sensitive devices in an ESD protected area only.

		VALUE	UNIT
V <sub>(ESD)</sub> Electrostatic discharge	Human-body model (HBM), per ANSI/ESDA/JEDEC JS-001 <sup>(1)</sup>	±6000	V
	Machine model (MM)	±400	V

- (1) JEDEC document JEP155 states that 500 V HBM allows safe manufacturing with a standard ESD control process.



### ESD SENSITIVITY CAUTION

ESD damage can range from subtle performance degradation to complete device failure. Precision integrated circuits may be more susceptible to damage because very small parametric changes could cause the device not to meet its published specifications.

### 8.2 Recommended Operating Conditions

over operating free-air temperature range (unless otherwise noted) <sup>(1)</sup>

		MIN	MAX	UNIT
V <sub>IN</sub>	Input supply voltage	1.7	7.5	V
V <sub>EN</sub>	Enable input voltage	0	V <sub>IN</sub>	V
I <sub>OUT</sub>	Output current	0	500	mA
T <sub>A</sub>	Operating temperature	-40	+85	°C

- (1) All voltages are with respect to the GND pin.

### 8.3 Thermal Information

THERMAL METRIC <sup>(1)</sup>		RS3236	RS3236	RS3236	RS3236	RS3236	UNIT
		UTDFN-1x1-4	SOT353 (SC70-5)	SOT23-5	SOT23-3	SOT89-3L (L-Type)	
		4 PINS	5 PINS	5 PINS	3 PINS	3 PINS	
R <sub>θJA</sub>	Junction-to-ambient thermal resistance	312.5	312.5	250	312.5	208.3	°C/W
R <sub>θJC(top)</sub>	Junction-to-case (top) thermal resistance	137.9	141.8	84.3	134.3	88.5	°C/W
R <sub>θJB</sub>	Junction-to-board thermal resistance	83.5	84.5	39.5	84.5	39.6	°C/W
ψ <sub>JT</sub>	Junction-to-top characterization parameter	5.3	3.9	2.86	4.8	26.5	°C/W
ψ <sub>JB</sub>	Junction-to-board characterization parameter	83.8	82.1	58.7	81.5	49.7	°C/W
R <sub>JC(bot)</sub>	Junction-to-case (bottom) thermal resistance	71.8	N/A	N/A	N/A	77.7	°C/W
P <sub>d</sub>	Power Dissipation	0.4	0.4	0.5	0.4	0.6	W

(1) Thermal resistance varies with operating conditions.

## 8.4 ELECTRICAL CHARACTERISTICS

( $V_{IN} = V_{OUT(NOMINAL)} + 0.5V^{(1)}$ , Full =  $-40^{\circ}C$  to  $+85^{\circ}C$ , unless otherwise noted.)

PARAMETER	SYMBOL	CONDITIONS		TEMP	MIN	TYP	MAX	UNITS
Input Voltage	$V_{IN}$			$+25^{\circ}C$	1.7 <sup>(1)</sup>		7.5	V
Output Voltage Accuracy		$I_{OUT} = 0.1mA$		$+25^{\circ}C$	-2.5		2.5	%
		$I_{OUT} = 0.1mA$ , RS3236-xxA		$+25^{\circ}C$	-1		1	%
Feedback Voltage	$V_{FB}$	$I_{OUT} = 0.1mA$ , RS3236-ADJ8		$+25^{\circ}C$	0.79	0.81	0.83	V
		$I_{OUT} = 0.1mA$ , RS3236-ADJC		$+25^{\circ}C$	1.18	1.21	1.24	V
Maximum Output Current				$+25^{\circ}C$	500			mA
Current Limit	$I_{LIM}$			$+25^{\circ}C$	500	800		mA
Ground Pin Current	$I_Q$	No load		$+25^{\circ}C$		30	40	$\mu A$
Dropout Voltage <sup>(2)</sup>	$V_{DROP}$	$I_{OUT} = 500mA$	$V_{OUT}=1.2V$	$+25^{\circ}C$		900		mV
			$V_{OUT}=1.5V$			630		
			$V_{OUT}=3.3V$			450	600	
Line Regulation	$\Delta V_{LNR}$	$V_{IN} = (V_{OUT} + 0.5V)$ to 5.5V, $I_{OUT} = 1mA$		$+25^{\circ}C$		0.1	0.2	%/V
Load Regulation	$\Delta V_{OUT}$	$I_{OUT} = 0.1mA$ to 500mA, $C_{OUT} = 1\mu F$		$+25^{\circ}C$		30	60	mV
		$I_{OUT} = 0.1mA$ to 500mA, $C_{OUT} = 1\mu F$ , RS3236-ADJ		$+25^{\circ}C$		0.5	10	mV
Output Voltage Noise	$e_n$	$f = 10Hz$ to 100kHz, $C_{BP} = 0.01\mu F$ , $C_{OUT} = 10\mu F$ , $I_{OUT}=30mA$		$+25^{\circ}C$		68		$\mu VRMS$
Output Voltage Temperature Coefficient	$\frac{\Delta V_{OUT}}{\Delta T_A \times V_{OUT}}$	$I_{LOAD} = 0.1mA$		FULL		35		ppm/ $^{\circ}C$
Power Supply Rejection Ratio	PSRR	$C_{BP} = 0\mu F$ , $I_{LOAD} = 30mA$ , $C_{OUT} = 1\mu F$ , $V_{IN} = V_{OUT}+1V$ $\Delta V_{RIPPLE}=0.2V_{P-P}$	$f = 217Hz$	$+25^{\circ}C$		72		dB
			$f = 1kHz$			70		
		$C_{BP} = 10nF$ , $I_{LOAD} = 30mA$ , $C_{OUT} = 1\mu F$ , $V_{IN} = V_{OUT}+1V$ $\Delta V_{RIPPLE}=0.2V_{P-P}$	$f = 217Hz$	$+25^{\circ}C$		74	dB	
			$f = 1kHz$			70		
<b>SHUTDOWN</b>								
EN Input Threshold	$V_{IH}$	$V_{IN} = 1.7V$			Full	1.4		V
	$V_{IL}$				Full		0.4	
EN Input Threshold	$V_{IH}$	$V_{IN} = 7.5V$			Full	2.3		V
	$V_{IL}$				Full		0.8	
EN Input Bias Current	$I_{BH}$	$EN = 7.5V$		$+25^{\circ}C$		0.01	1	$\mu A$
	$I_{BL}$	$EN = 0V$		Full		0.01		
Shutdown Supply Current	$I_{Q(SHDN)}$	$EN = 0V$		Full		0.01	1	$\mu A$
Start-Up Time <sup>(3)</sup>	$t_{STR}$	$C_{OUT} = 1\mu F$ , No Load		$+25^{\circ}C$		180		$\mu s$
$R_{ON}$ of Discharge MOSFET		$V_{IN} = 4.0V$ , $V_{EN} = 0V$		$+25^{\circ}C$		260		$\Omega$
<b>THERMAL PROTECTION</b>								
Thermal Shutdown Temperature	$T_{SHDN}$					150		$^{\circ}C$
Thermal Shutdown Hysteresis	$\Delta T_{SHDN}$					15		$^{\circ}C$

## NOTES:

1.  $V_{IN} = V_{OUT(NOMINAL)} + 0.5V$  or  $1.7V$ , whichever is greater.
2. The dropout voltage is defined as  $V_{IN} - V_{OUT}$ , when  $V_{OUT}$  is 100mV below the value of  $V_{OUT}$  for  $V_{IN} = V_{OUT} + 0.5V$ .
3. Time needed for  $V_{OUT}$  to reach 90% of final value.

### 8.5 TYPICAL APPLICATION CIRCUIT

<p style="text-align: center;">Typical Circuit</p> <p style="text-align: center;"><b>RS3236</b></p> <p style="text-align: center;">SOT23-5/SOT353(SC70-5)</p>	<p style="text-align: center;">Typical Circuit</p> <p style="text-align: center;"><b>RS3236</b></p> <p style="text-align: center;">SOT23-5/SOT353(SC70-5)</p>
<p style="text-align: center;">Typical Circuit</p> <p style="text-align: center;"><b>RS3236-ADJ8</b></p> <p style="text-align: center;">SOT23-5/SOT353(SC70-5)</p>	<p style="text-align: center;">Typical Circuit</p> <p style="text-align: center;"><b>RS3236-ADJC</b></p> <p style="text-align: center;">SOT23-5/SOT353(SC70-5)</p>
<p>NOTE: Choose <math>R_2 = 160k\Omega</math> to maintain a <math>5\mu A</math> minimum load. Calculate the value for <math>R_1</math> using the following equation:</p> $R_1 = R_2 * \left( \frac{V_{OUT}}{0.81} - 1 \right)$	<p>NOTE: Choose <math>R_2 = 240k\Omega</math> to maintain a <math>5\mu A</math> minimum load. Calculate the value for <math>R_1</math> using the following equation:</p> $R_1 = R_2 * \left( \frac{V_{OUT}}{1.21} - 1 \right)$
<p style="text-align: center;">Typical Circuit</p> <p style="text-align: center;"><b>RS3236</b></p> <p style="text-align: center;">UTDFN-1x1-4</p>	

## 8.6 TYPICAL PERFORMANCE CHARACTERISTICS

NOTE: The graphs and tables provided following this note are a statistical summary based on a limited number of samples and are provided for informational purposes only.

$V_{IN} = V_{OUT (NOMINAL)} + 0.5V$ ,  $V_{OUT}=3.3V$ ,  $C_{IN} = 1\mu F$ ,  $C_{OUT} = 1\mu F$ ,  $C_{BP} = 0\mu F$ ,  $T_A = +25^{\circ}C$ , unless otherwise noted.

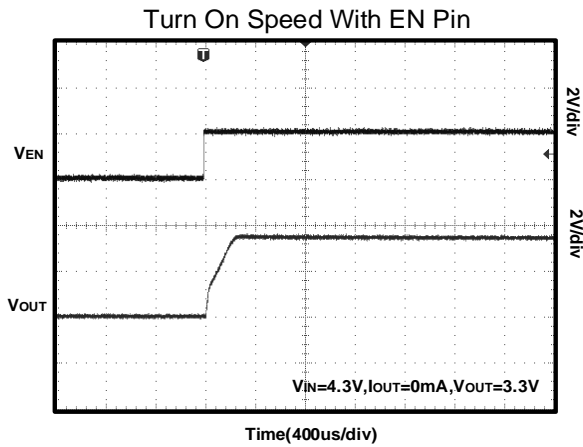

**Figure 1. Turn on Speed with EN Pin**

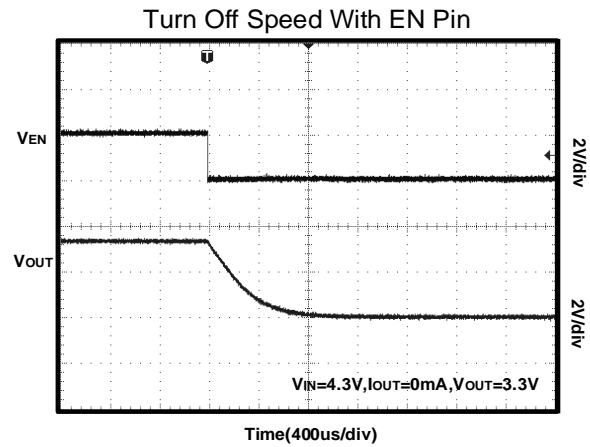

**Figure 2. Turn Off Speed with EN Pin**

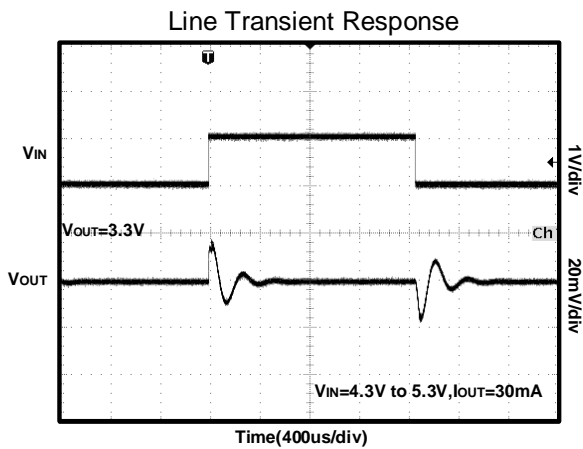

**Figure 3. Line Transient Response**

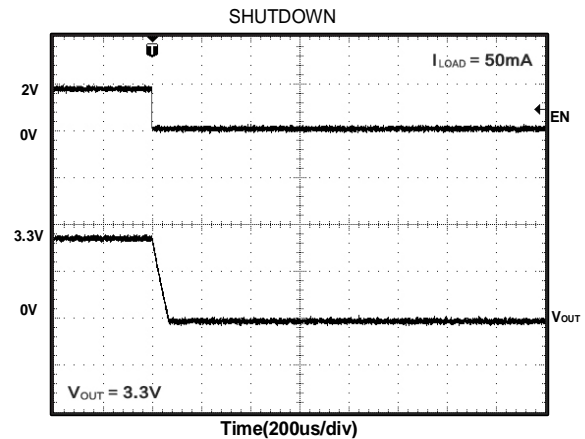

**Figure 4. SHUTDOWN**

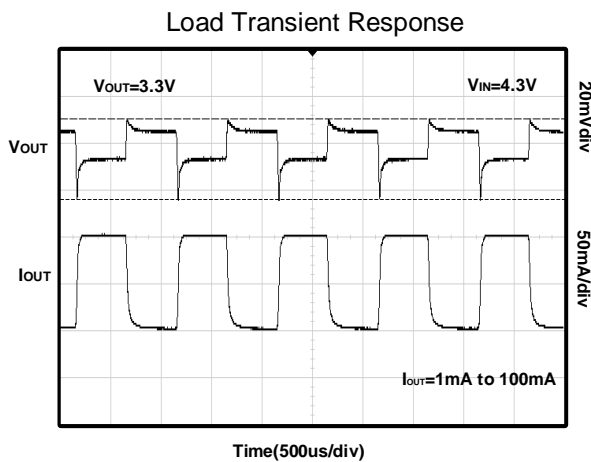

**Figure 5. Load Transient Response**

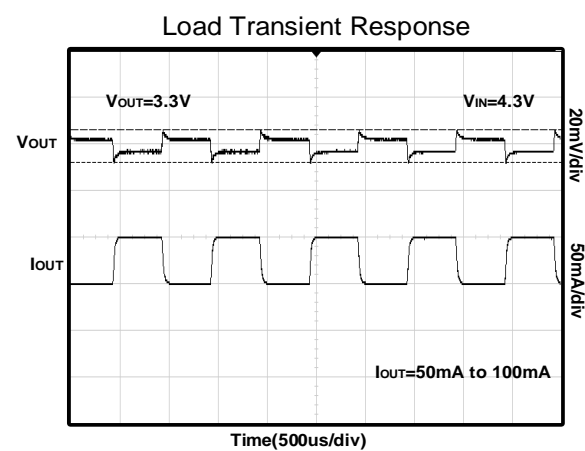

**Figure 6. Load Transient Response**

## TYPICAL PERFORMANCE CHARACTERISTICS

NOTE: The graphs and tables provided following this note are a statistical summary based on a limited number of samples and are provided for informational purposes only.

$V_{IN} = V_{OUT (NOMINAL)} + 0.5V$ ,  $V_{OUT}=3.3V$ ,  $C_{IN} = 1\mu F$ ,  $C_{OUT} = 1\mu F$ ,  $C_{BP} = 0.1\mu F$ ,  $T_A = +25^\circ C$ , unless otherwise noted.

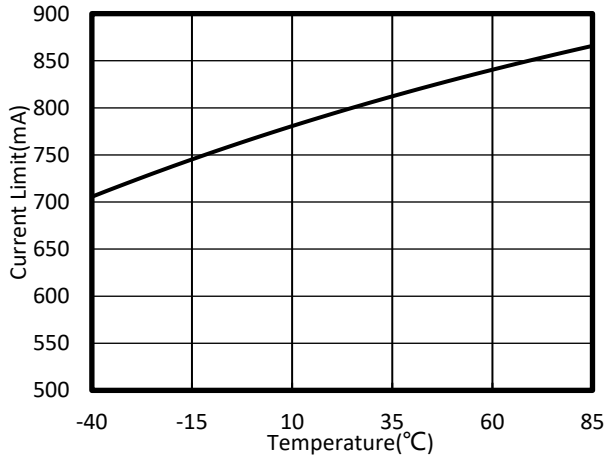

Figure 7. Current Limit vs Temperature

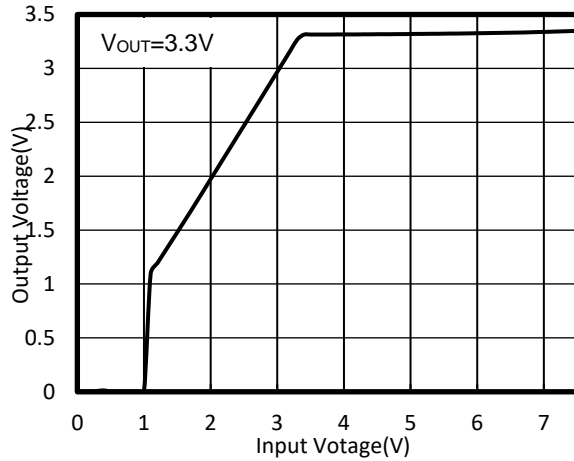

Figure 8. Output Voltage vs Input Voltage

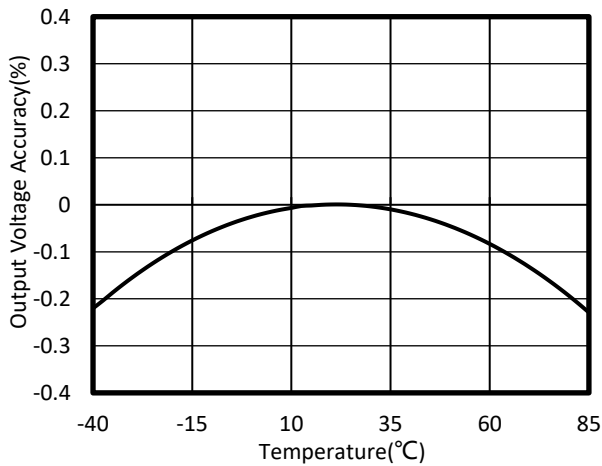

Figure 9. Output Voltage Accuracy vs Temperature

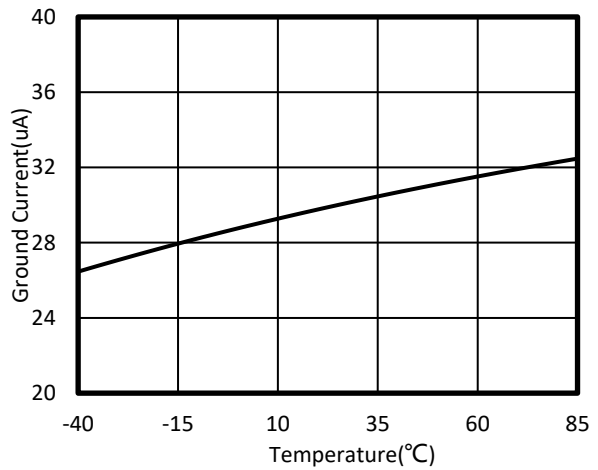

Figure 10. Ground Current vs Temperature

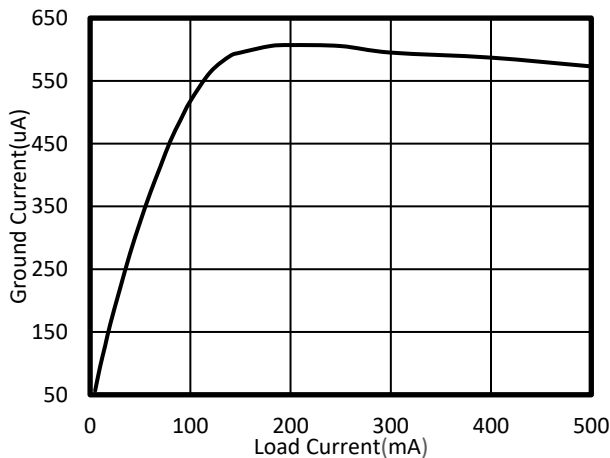
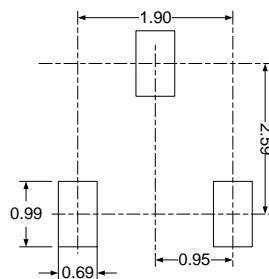
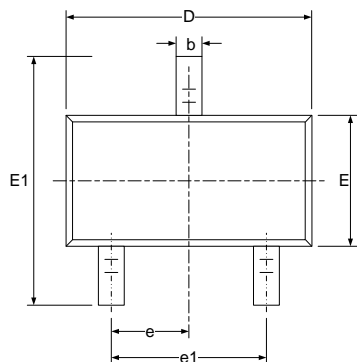
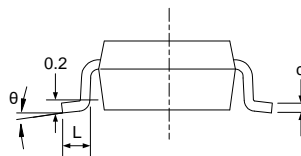
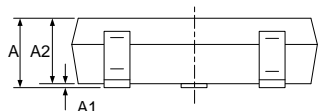

Figure 11. Ground Current vs Load Current

## 9 PACKAGE OUTLINE DIMENSIONS

### SOT23-3



**RECOMMENDED LAND PATTERN (Unit: mm)**

Symbol	Dimensions In Millimeters		Dimensions In Inches	
	Min	Max	Min	Max
A	1.050	1.250	0.041	0.049
A1	0.000	0.100	0.000	0.004
A2	1.050	1.150	0.041	0.045
b	0.300	0.500	0.012	0.020
c	0.100	0.200	0.004	0.008
D	2.820	3.020	0.111	0.119
E	1.500	1.700	0.059	0.067
E1	2.650	2.950	0.104	0.116
e	0.950(BSC)		0.037(BSC)	
e1	1.800	2.000	0.071	0.079
L	0.300	0.600	0.012	0.024
θ	0°	8°	0°	8°

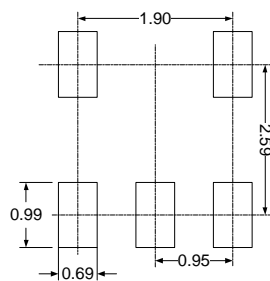
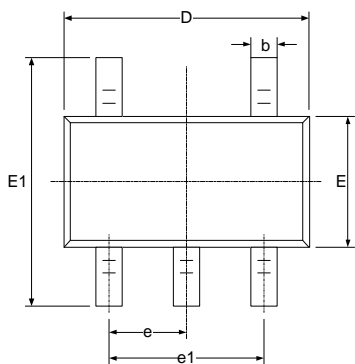
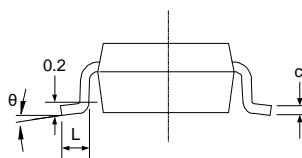
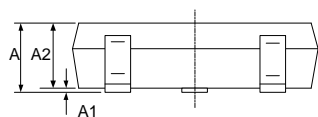

**SOT23-5**

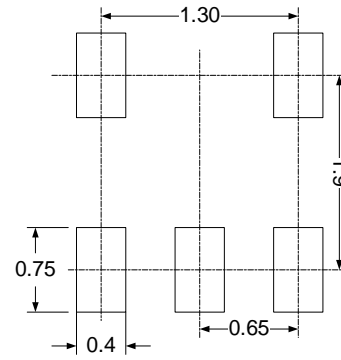
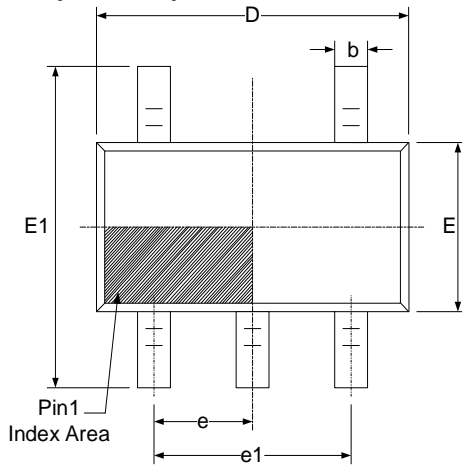
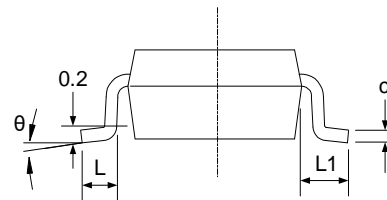
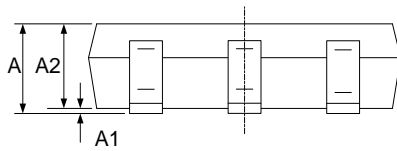
**RECOMMENDED LAND PATTERN (Unit: mm)**

Symbol	Dimensions In Millimeters		Dimensions In Inches	
	Min	Max	Min	Max
A	1.050	1.250	0.041	0.049
A1	0.000	0.100	0.000	0.004
A2	1.050	1.150	0.041	0.045
b	0.300	0.500	0.012	0.020
c	0.100	0.200	0.004	0.008
D	2.820	3.020	0.111	0.119
E	1.500	1.700	0.059	0.067
E1	2.650	2.950	0.104	0.116
e	0.950(BSC)		0.037(BSC)	
e1	1.800	2.000	0.071	0.079
L	0.300	0.600	0.012	0.024
θ	0°	8°	0°	8°

**SOT353(SC70-5)**

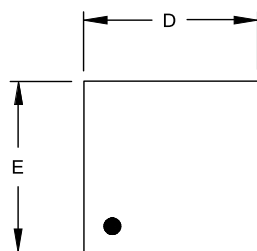
**RECOMMENDED LAND PATTERN (Unit: mm)**

Symbol	Dimensions In Millimeters		Dimensions In Inches	
	Min	Max	Min	Max
A	0.900	1.100	0.035	0.043
A1	0.000	0.100	0.000	0.004
A2	0.900	1.000	0.035	0.039
b	0.150	0.350	0.006	0.014
c	0.080	0.150	0.003	0.006
D	2.000	2.200	0.079	0.087
E	1.150	1.350	0.045	0.053
E1	2.150	2.450	0.085	0.096
e	0.650(BSC)		0.026(BSC)	
e1	1.300(BSC)		0.051(BSC)	
L	0.260	0.460	0.010	0.018
L1	0.525		0.021	
$\theta$	0°	8°	0°	8°

**UTDFN-1x1-4**

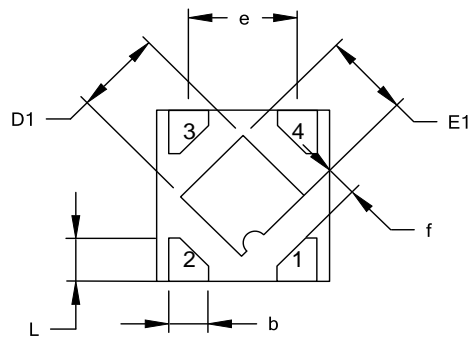
TOP VIEW



BOTTOM VIEW

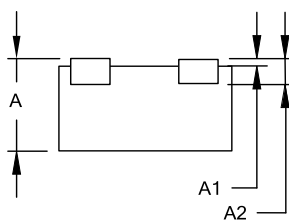

SIDE VIEW

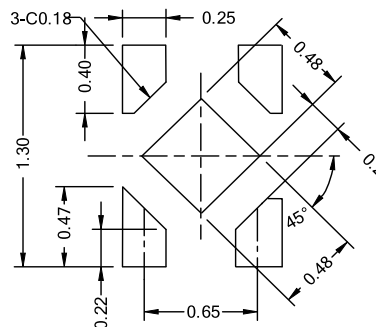

RECOMMENDED LAND PATTERN (Unit: mm)

Symbol	Dimensions In Millimeters			Dimensions In Inches		
	MIN	MOD	MAX	MIN	MOD	MAX
A	0.340	0.370	0.400	0.013	0.015	0.016
A1	0.000	0.020	0.050	0.000	0.001	0.002
A2	0.100 REF			0.004 REF		
D	0.950	1.000	1.050	0.037	0.039	0.041
D1	0.430	0.480	0.530	0.017	0.019	0.021
E	0.950	1.000	1.050	0.037	0.039	0.041
E1	0.430	0.480	0.530	0.017	0.019	0.021
b	0.170	0.220	0.270	0.007	0.009	0.011
e	0.600	0.650	0.700	0.024	0.026	0.028
f	0.195 REF			0.008 REF		
L	0.200	0.250	0.300	0.008	0.010	0.012

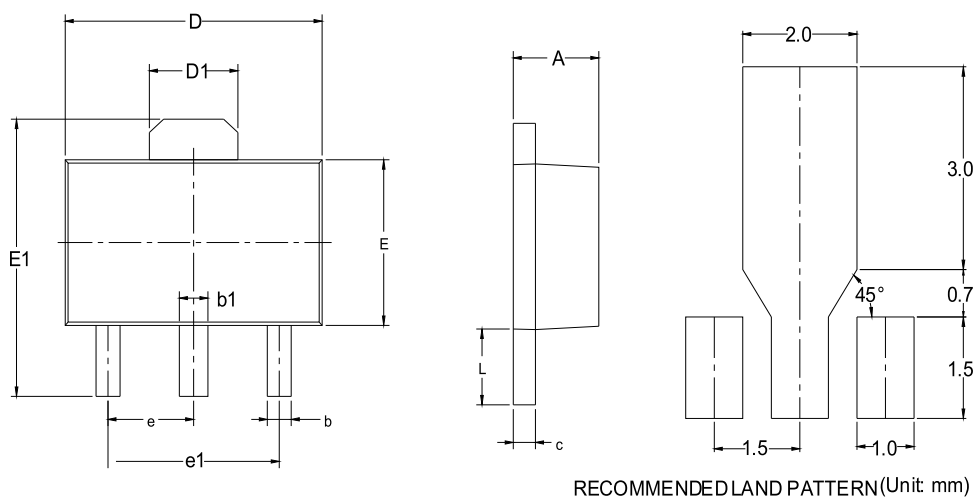
**SOT89-3L**

Symbol	Dimensions In Millimeters		Dimensions In Inches	
	Min	Max	Min	Max
A	1.400	1.600	0.055	0.063
b	0.320	0.520	0.013	0.020
b1	0.400	0.580	0.016	0.023
c	0.350	0.440	0.014	0.017
D	4.400	4.600	0.173	0.181
D1	1.550 REF		0.061 REF	
E	2.300	2.600	0.091	0.102
E1	3.940	4.250	0.155	0.167
e	1.500 BSC		0.060 BSC	
e1	3.000 BSC		0.118 BSC	
L	0.900	1.200	0.035	0.047

**NOTE:**

- A. All linear dimension is in millimeters.
- B. This drawing is subject to change without notice.
- C. Body dimensions do not include mold flash or protrusion. Mold flash and protrusion shall not exceed 0.15 per side.
- D. BSC: Basic Dimension. Theoretically exact value shown without tolerances.
- E. REF: Reference Dimension, usually without tolerance, for information purposes only.

# 10 TAPE AND REEL INFORMATION

## REEL DIMENSIONS

## TAPE DIMENSION

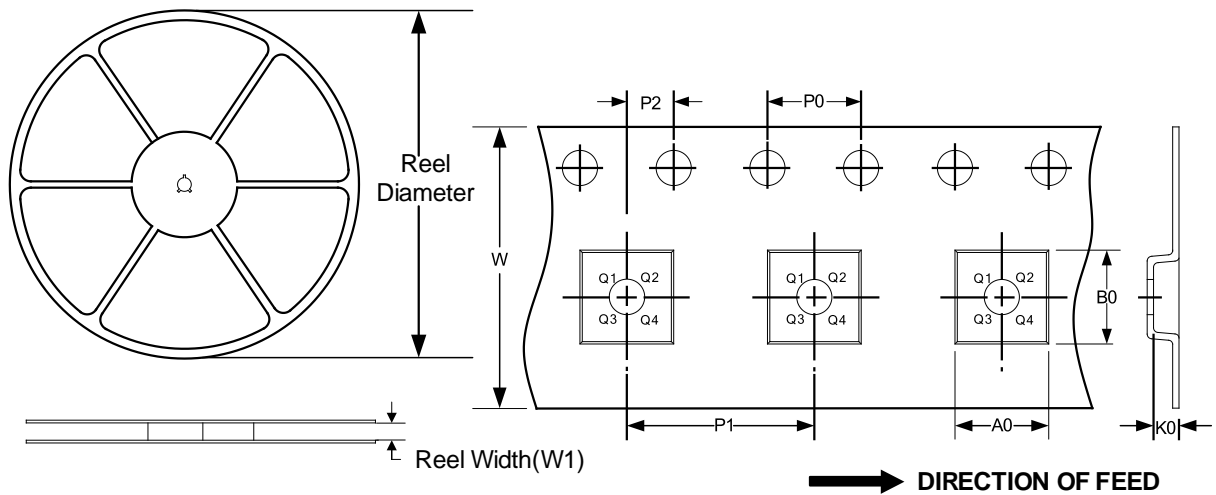

NOTE: The picture is only for reference. Please make the object as the standard.

### KEY PARAMETER LIST OF TAPE AND REEL

Package Type	Reel Diameter	Reel Width(mm)	A0 (mm)	B0 (mm)	K0 (mm)	P0 (mm)	P1 (mm)	P2 (mm)	W (mm)	Pin1 Quadrant
UTDFN1 x 1-4L	7"	9.5	1.16	1.16	0.5	4.0	4.0	2.0	8.0	Q1
SOT23-3	7"	9.0	3.20	3.30	1.30	4.0	4.0	2.0	8.0	Q3
SOT23-5	7"	9.5	3.20	3.20	1.40	4.0	4.0	2.0	8.0	Q3
SOT353(SC70-5)	7"	9.5	2.25	2.55	1.20	4.0	4.0	2.0	8.0	Q3
SOT89-3L	7"	13.2	4.85	4.45	1.85	4.0	8.0	2.0	12.0	Q3

NOTE:

1. All dimensions are nominal.
2. Plastic or metal protrusions of 0.15mm maximum per side are not included.

## **IMPORTANT NOTICE AND DISCLAIMER**

Jiangsu Runic Technology Co., Ltd. will accurately and reliably provide technical and reliability data (including data sheets), design resources (including reference designs), application or other design advice, WEB tools, safety information and other resources, without warranty of any defect, and will not make any express or implied warranty, including but not limited to the warranty of merchantability Implied warranty that it is suitable for a specific purpose or does not infringe the intellectual property rights of any third party.

These resources are intended for skilled developers designing with Runic products You will be solely responsible for: (1) Selecting the appropriate products for your application; (2) Designing, validating and testing your application; (3) Ensuring your application meets applicable standards and any other safety, security or other requirements; (4) Runic and the Runic logo are registered trademarks of Runic Incorporated. All trademarks are the property of their respective owners; (5) For change details, review the revision history included in any revised document. The resources are subject to change without notice. Our company will not be liable for the use of this product and the infringement of patents or third-party intellectual property rights due to its use.