

## Features

- Ultra High Efficiency (Up to 92%)
- Four Channels Output
- Active Power Factor Correction (0.99 Typical)
- Constant Current Output
- Lightning Protection
- All-Round Protection: SCP, OTP, OVP
- Waterproof (IP67) and Damp & Wet Location



## Description

The EUC-160QxxxDT(ST) series operate from a 90 ~ 305 Vac input range. They are designed to be highly efficient and highly reliable. Features include lightning protection, short circuit protection, over voltage protection and over temperature protection.

## Models

Output Current (1)	Input Voltage Range	Output Voltage Range	Max. Output Power	Typical Efficiency (2)	Power Factor		Model Number (3)
					120Vac	220Vac	
350 mA	90 ~ 305 Vac	57~114Vdc	160 W	92.0%	0.99	0.95	EUC-160Q035DT(ST)(4)
450 mA	90 ~ 305 Vac	45~90 Vdc	160 W	92.0%	0.99	0.95	EUC-160Q045DT(ST)(4)(7)
600 mA	90 ~ 305 Vac	40~70 Vdc	168 W	91.5%	0.99	0.95	EUC-160Q060DT(ST)(4)(7)
700 mA	90 ~ 305 Vac	29~57 Vdc	160 W	91.5%	0.99	0.95	EUC-160Q070DT(ST)(4)(7)
1050 mA	90 ~ 305 Vac	19~38 Vdc	160 W	90.0%	0.99	0.95	EUC-160Q105DT(ST)(5)(7)
1400 mA	90 ~ 305 Vac	14~29 Vdc	160 W	90.0%	0.99	0.95	EUC-160Q140DT(ST)(6)(7)

**Notes:** (1) The output current is adjustable at factory from 50% to 100%.

(2) Measured at full load and 220 Vac input.

(3) A suffix -xxxx may be added to denote variations or modifications to the base product, where x can be any alphanumeric character or blank. .

(4) Non-Class2 output (USR & CNR).

(5) Class 2 output (USR), Non-Class 2 output (CNR).

(6) Class 2 output (USR), Class 2 output (CNR) for Wet location.

(7) SELV

## Input Specifications

Parameter	Min.	Typ.	Max.	Notes
Input Voltage	90 V	-	305 V	
Input Frequency	47 Hz	-	63 Hz	
Leakage Current	-	-	1 mA	At 277Vac 60Hz input
Input AC Current	-	-	2.1 A	Measured at full load and 100 Vac input.
	-	-	0.9 A	Measured at full load and 220 Vac input.

Specifications are subject to changes without notice.

## Input Specifications (Continued)

Parameter	Min.	Typ.	Max.	Notes
Inrush current	-	-	65 A	At 220Vac input, 25°C cold start, duration=1 ms, 10%Ipk-10%Ipk.
Inrush Current(I <sup>2</sup> t)	-	-	1.7 A <sup>2</sup> s	
Power Factor	0.90	-	-	At 100Vac-220Vac, 75%load-100%load
THD	-	-	20%	At 100Vac-277Vac, 75%load-100%load

## Output Specifications

Parameter	Min.	Typ.	Max.	Notes
Output channel	-	4	-	
Output Current Tolerance	-5%		5%	
No-load Output Voltage				
I <sub>o</sub> =350 mA	-	-	123 V	
I <sub>o</sub> =450 mA	-	-	97 V	
I <sub>o</sub> =600 mA	-	-	77 V	
I <sub>o</sub> =700 mA	-	-	64 V	
I <sub>o</sub> =1050 mA	-	-	51 V	
I <sub>o</sub> =1400 mA	-	-	41 V	
Output Current Ripple (pk-pk)	-	10% I <sub>o</sub>	15% I <sub>o</sub>	
Output Overshoot / Undershoot	-	-	10%	When power on or off.
Line Regulation	-	-	±1%	
Load Regulation	-	-	±3%	
Turn-on Delay Time	-	1.0 s	2.0 s	Measured at 120Vac input.
	-	0.5 s	1.5 s	Measured at 220Vac input.
Temperature coefficient	-	-	0.02%/°C	Case temperature = 0°C ~T <sub>c</sub> max

**Note:** All specifications are typical at 25 °C unless otherwise stated.

## Protection Functions

Parameter	Min.	Typ.	Max.	Notes
Over Temperature Protection-T <sub>c</sub>	-	120 °C	-	When OTP occurs, the output current decreases down to the half of the normal output current. The output shall be auto recovery when the temperature becomes normal.
Short Circuit Protection	Single or dual channel short does not affect the normal work of other channels. The driver recovers after short is removed and AC input recycled. Three or four channel short latches the driver and it recovers after the short is removed.			

## General Specifications

Parameter	Min.	Typ.	Max.	Notes
Efficiency Io=350 mA Io=450 mA Io=600 mA Io=700 mA Io=1050 mA Io=1400 mA	88.0% 88.0% 87.5% 87.5% 86.0% 86.0%	89.0% 89.0% 88.5% 88.5% 87.0% 87.0%	- - - - - -	Measured at full load, 120Vac input, 25°C ambient temperature, after the unit is thermally stabilized. It will be about 1% lower, if measured immediately after startup.
Efficiency Io=350 mA Io=450 mA Io=600 mA Io=700 mA Io=1050 mA Io=1400 mA	91.0% 91.0% 90.5% 90.5% 89.0% 89.0%	92.0% 92.0% 91.5% 91.5% 90.0% 90.0%	- - - - - -	Measured at full load, 220Vac input, 25°C ambient temperature, after the unit is thermally stabilized. It will be about 1% lower, if measured immediately after startup.
MTBF	-	200,400 Hours	-	Measured at 220Vac input, 80%Load and 25°C ambient temperature (MIL-HDBK-217F)
Life Time	-	90,400 Hours	-	Measured at 220Vac input, 80%Load; Case temperature=60°C @ Tc point. See life time vs. Tc curve for the details
Case temperature	-	-	90°C	
Dimensions Inches (L × W × H) Millimeters (L × W × H)	7.40× 3.46 × 1.5 188 ×88 × 38			
Net Weight	-	1340 g	-	

**Note:** All specifications are typical at 25 °C unless otherwise stated.

## Environmental Specifications

Parameter	Min.	Typ.	Max.	Notes
Operating Temperature	-40 °C	-	+70 °C	Humidity: 10% RH to 100% RH; See Derating Curve for more details
Storage Temperature	-40 °C	-	+85 °C	Humidity: 5% RH to 100% RH

## Safety & EMC Compliance

Safety Category	Standard
UL/CUL	UL8750, UL1012, UL1310 Class 2, CSA-C22.2 No. 107.1, CSA C22.2 NO. 223-M91 Class 2
CE	EN 61347-1, EN61347-2-13
EMI Standards	Notes
EN 55015	Conducted emission Test & Radiated emission Test
EN 61000-3-2	Harmonic current emissions
EN 61000-3-3	Voltage fluctuations & flicker
FCC Part 15	ANSI C63.4: 2009 Class B

Specifications are subject to changes without notice.

## Safety & EMC Compliance (Continued)

EMS Standards	Notes
EN 61000-4-2	Electrostatic Discharge (ESD): 15 kV air discharge, 8 kV contact discharge
EN 61000-4-3	Radio-Frequency Electromagnetic Field Susceptibility Test-RS
EN 61000-4-4	Electrical Fast Transient / Burst-EFT
EN 61000-4-5	Surge Immunity Test: AC Power Line: line to line 4 kV, line to earth 6 kV
EN 61000-4-6	Conducted Radio Frequency Disturbances Test-CS
EN 61000-4-8	Power Frequency Magnetic Field Test
EN 61000-4-11	Voltage Dips
EN 61547	Electromagnetic Immunity Requirements Applies To Lighting Equipment

## Derating Curve

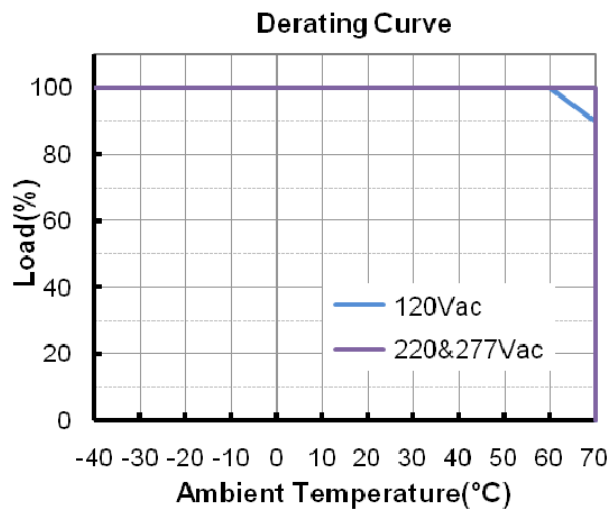

## Life Time vs. Case Temperature Curve

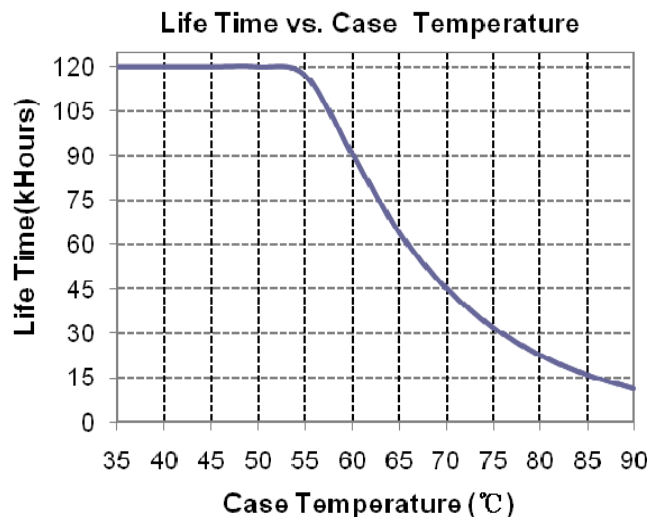

Specifications are subject to changes without notice.

## Efficiency vs. Load (350 mA)

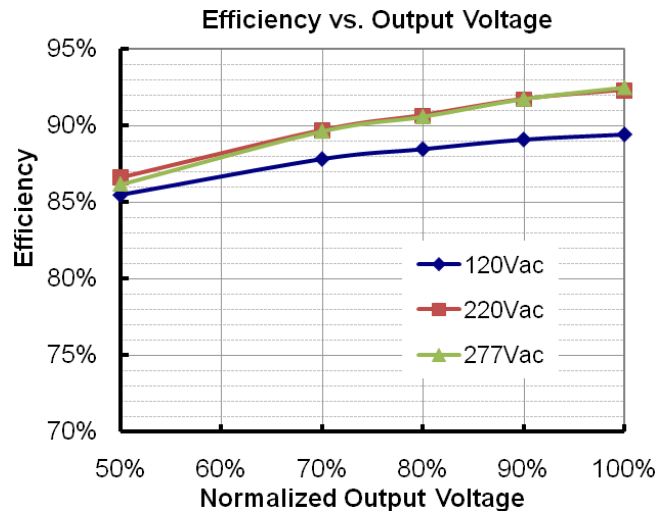

## Power Factor Characteristics (350 mA)

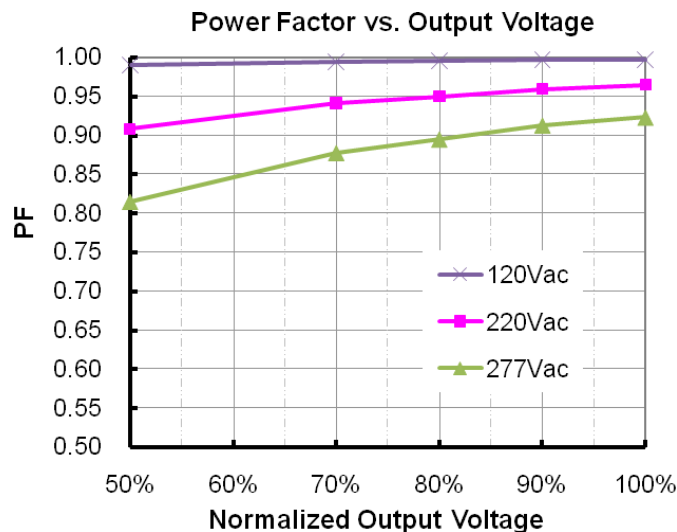

## Dimming Control (On secondary side)

Parameter	Min.	Typ.	Max.	Notes
12V output voltage (Vc)	10.8 V	12 V	13.2 V	
12V Output source current	0 mA		20 mA	
Absolute maximum voltage on the 1~10V input pin	0 V	-	12 V	
Source current on 1~10V input pin	0 uA	-	200 uA	

The dimmer control may be operated from either a potentiometer or from an input signal of 1 – 10 Vdc. Two recommended implementations are provided below.

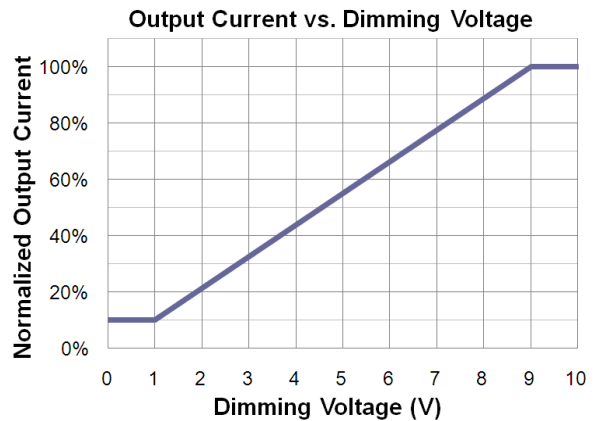
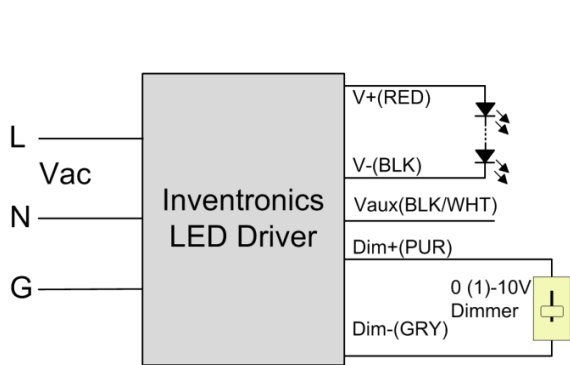

### Implementation: DC input

#### Notes:

1.  $I_o$  is actual output current and  $I_r$  is rated current without dimming control.
2. For the driver to operate properly, the load voltage must be maintained above the minimum voltage threshold (approx. 60% of the max. output voltage for any given model).
3. If the output voltage is maintained above 60% of the maximum output voltage, the dimming control may be operated over the entire 1-10V range with output current varying from 10% to 100% of  $I_r$ .
4. The dimming signal is allowed to be less than 1V, however, when it is for 0-1V, the output current is 10%  $I_o$ .
5. Do not connect the GND of dimming to the output; otherwise, the LED driver cannot work normally.

### Mechanical Outline

#### EUC-160QxxxDT

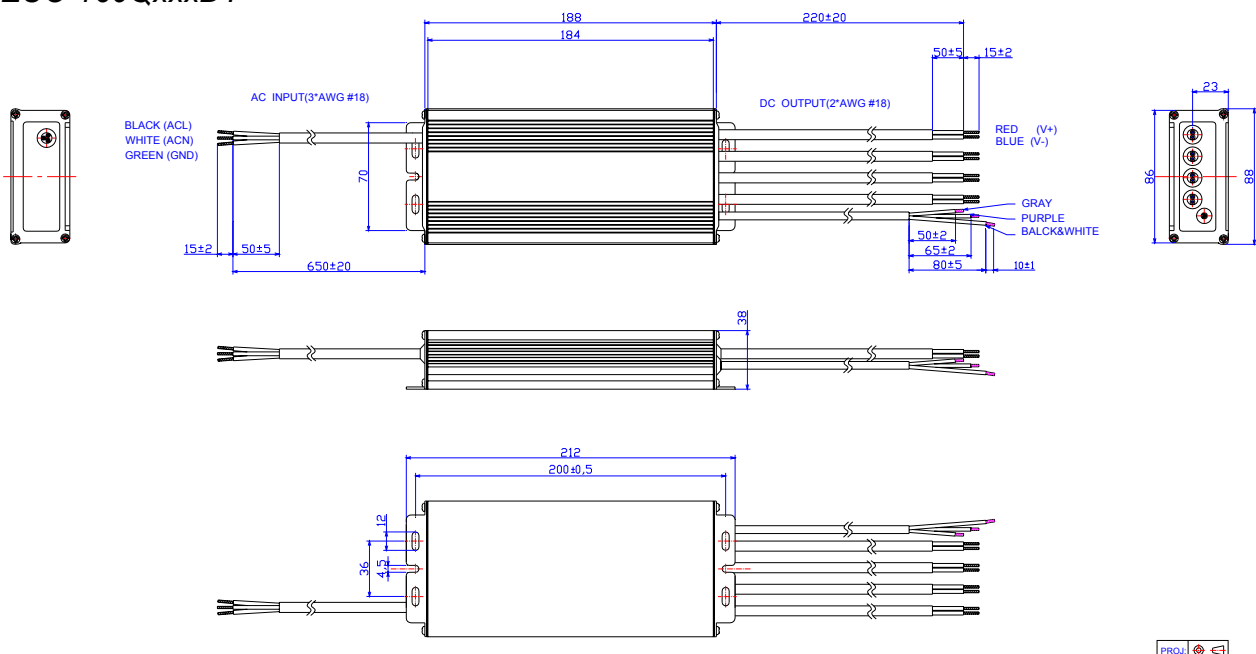

Specifications are subject to changes without notice.

## EUC-160QxxxST

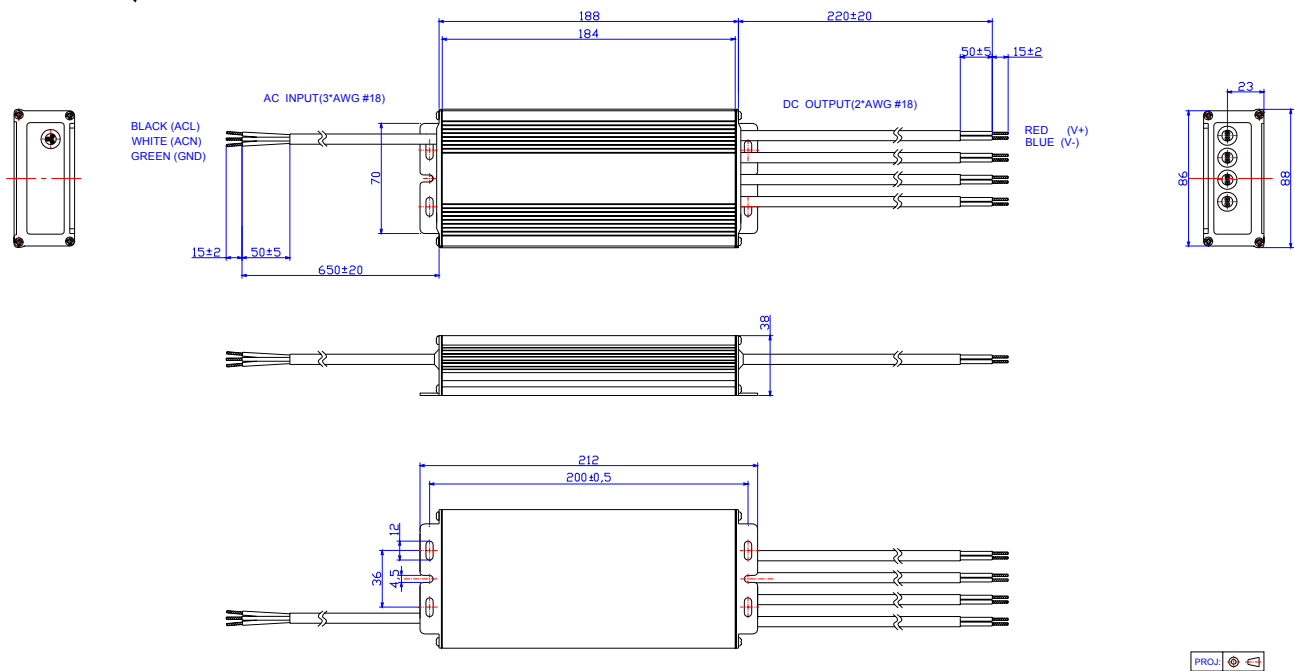

## RoHS Compliance

Our products comply with the European Directive 2002/95/EC, calling for the elimination of lead and other hazardous substances from electronic products.

## Revision History

Change Date	Rev.	Description of Change		
		Item	From	To
2012-3-6	A	Datasheets Release	/	/
2012-05-02	B	450 mA Model	/	Added
		1400 mA Model	/	Added
		Output Power---600mA Updated	160W	168W
		No Load Output Voltage	/	Updated
		Class 2 Corrected	/	/
		Efficiency, PF Curve	/	Corrected
2012-5-14	C	Operating Temperature	-35°C	-40°C
		Max of No Load Voltage Added	/	/
2012-05-22	D	Output Current Ripple (pk-pk) Max	30% Io	15% Io
		Inrush Current	50 A	65 A
2012-07-09	E	Derating Curve	/	Updated
2012-07-17	F	Max Case Temperature	/	Updated
2012-09-05	G	Derating Curve	/	Updated
		Life time Curve	/	Updated
		Turn-on delay time @120Vac	Type 1.0s, max 3.0s	Type 1.0s, max 2.0s
		Turn-on delay time @220Vac	Type 1.0s, max 3.0s	Type 0.5s, max 1.5s
		PF Min	/	Added
		THD Max	/	Added
		Inrush Current(I <sup>2</sup> t)	/	Added
		Temperature co-efficient	/	Added
2012-11-07	H	Over Temperature Protection-Tc	115 °C	120 °C
		Wet location of models corrected	/	/

Specifications are subject to changes without notice.