

HF157F

MINIATURE INTERMEDIATE POWER RELAY



File No.:E133481



File No.:R50403813



File No.:CQC18002189443

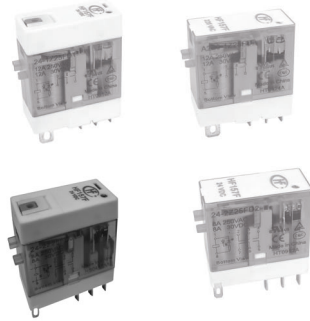

Features

- High capacity (1 pole:16A;2 pole:10A)
- Various types available
- 1/2 pole configurations
- 5kV dielectric strength (between coil and contacts)
- Sockets available

CONTACT DATA

Contact arrangement	1Z,2Z
Contact resistance ¹⁾	100mΩ (1A 6VDC)
Contact material	AgSnO ₂ Alloy
Contact rating(Res. load)	1Z:12A 250VAC/30VDC 2Z:8A 250VAC/30VDC
Max. switching voltage	250VAC/30VDC
Max. switching current	1Z:16A 2Z:10A
Max. switching power	1Z:4000VA/480W 2Z:2500VA/300W
Mechanical endurance	AC:3 x 10 ⁷ OPS DC:5 x 10 ⁷ OPS
Electrical endurance	1 x 10 ⁵ OPS (1Z:12A 250VAC/30VDC, Resistive load, Room temp, 1s on 9s off, NO or NC) (2Z:8A 250VAC/30VDC, Resistive load, Room temp, 1s on 9s off, NO or NC)

Notes: 1) The data shown above are initial values.

CHARACTERISTICS

Insulation resistance	1000MΩ (at 500VDC)	
Dielectric strength	Between coil & contacts	5000VAC 1min
	Between open contacts	1000VAC 1min
	Between contact sets	3000VAC 1min
Operate time (at nomi. volt.)	15ms max.	
Release time (at nomi. volt.)	20ms max. (AC, With diode or RC circuit) DC: 10ms max.	
Shock resistance	Functional	98m/s ²
	Destructive	980m/s ²
Vibration resistance	10Hz to 55Hz 1.5mm DA	
Humidity	5% to 85% RH	
Ambient temperature	-40°C to 70°C	
Termination	Plug-in	
Unit weight	Approx. 23.5g(button type) Approx.22g (without button type)	
Construction	Dust protected	

Notes: 1) The data shown above are initial values.

COIL

Coil power	DC: 0.53W; AC: 0.9VA
------------	----------------------

COIL DATA

at 23°C

Nominal Voltage VDC	Pick-up Voltage VDC ¹⁾	Drop-out Voltage VDC ¹⁾	Max. Allowable Voltage VDC ²⁾	Coil Resistance Ω
5	3.5	0.5	5.5	47.2 x (1±10%)
6	4.2	0.6	6.6	67.9 x (1±10%)
12	8.4	1.2	13.2	271 x (1±10%)
24	16.8	2.4	26.4	1080 x (1±10%)
36	25.2	3.6	39.6	2445 x (1±10%)
48	33.6	4.8	52.8	4340 x (1±10%)
60	42	6	66	6792 x (1±10%)
100~110	77	11	110~121	18870 x (1±10%)

Nominal Voltage VAC	Pick-up Voltage VAC ¹⁾	Drop-out Voltage VAC ¹⁾	Max. Allowable Voltage VAC ²⁾	Coil Resistance Ω
6	4.8	1.8	6.6	16 x (1±10%)
12	9.6	3.6	13.2	62.5 x (1±10%)
24	19.2	7.2	26.4	243x (1±10%)
48	38.4	14.4	52.8	1085 x (1±10%)
60	48	18	66	1750 x (1±10%)
110	88	33	121	5270x (1±10%)
115	92	34.5	126.5	6030 x (1±10%)
120	96	36	132	6400 x (1±10%)
220	176	66	242	21530 x (1±10%)
230	184	69	253	24100 x (1±10%)
240	192	72	264	25570 x (1±10%)

Notes: 1) The data shown above are initial values.

2) Maximum voltage refers to the maximum voltage which relay coil could endure in a short period of time.



HONGFA RELAY

ISO9001, IATF16949, ISO14001, ISO45001, IECQ QC 080000, ISO/IEC 27001 CERTIFIED

2023 Rev. 2.00

SAFETY APPROVAL RATINGS

UL/CUL	1C	12A 250VAC/30VDC Resistive load 70°C 16A 250VAC/30VDC Resistive load 70°C
	2C	8A 250VAC/30VDC Resistive load 70°C 10A 250VAC/30VDC Resistive load 70°C
TÜV	1C	12A 250VAC/30VDC Resistive load 70°C 16A 250VAC/30VDC Resistive load 70°C
	2C	8A 250VAC/30VDC Resistive load 70°C 10A 250VAC/30VDC Resistive load 70°C

Notes: Only some typical ratings are listed above. If more details are required, please contact us.

ORDERING INFORMATION

Type	HF157F / A 24 -1Z 2 5 F D 2 (XXX)		
Coil voltage form	A: AC	Nil: DC	
Coil voltage	AC: 6 to 240VAC DC: 5 to 110VDC		
Contact arrangement	1Z: 1 Form C 2Z: 2 Form C		
Termination	2: QC		
Contact material	5: AgSnO ₂ Alloy		
Insulation standard	F: Class F		
Component code ¹⁾	D: With LED DJ: With LED and diode(1:"-")	DJ1: With diode(1:"+") DE: LED、RC circuit	
Mounting termination	1:button type 2:Without button type		
Customer special code ²⁾	XXX: Customer special requirement		Nil: Standard

Notes:1) Assembled component with "J"freewheel diode, applied in DC coil type, with "E" RC circuit board, applied in AC coil type.

2) The customer special requirement express as special code after evaluating by Hongfa.

Outline Dimensions

HF157F/□□□□-1Z25FD2 (□□□)

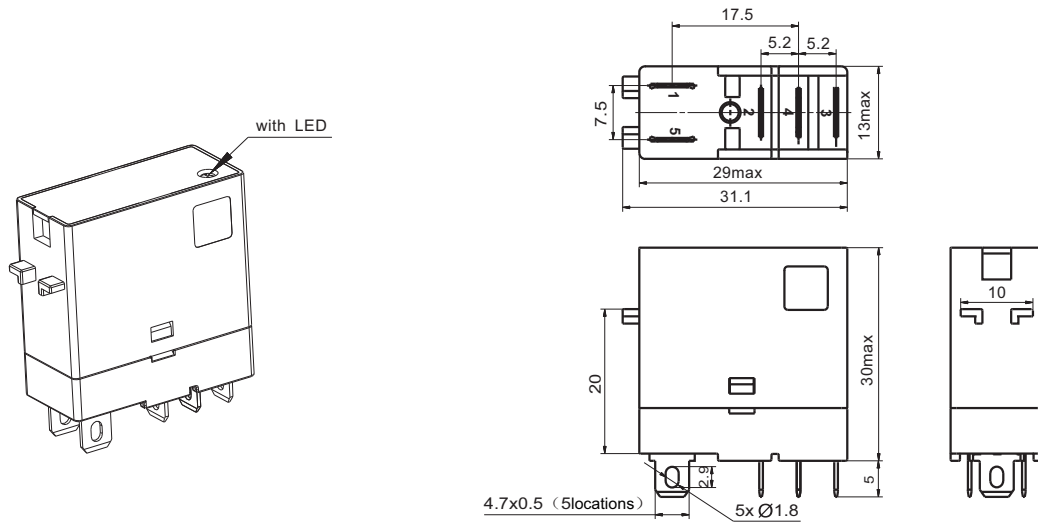

Wiring Diagram
(Bottom view)

HF157F/□□□□-1Z25FD2(□□□)
(With LED)

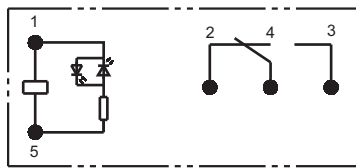

HF157F/□□□□-1Z25FDJ2(□□□)
(With LED, fly-wheel diode1:"-")

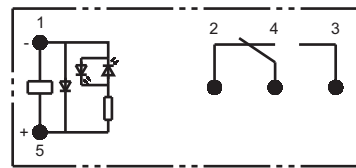

HF157F/□□□□-1Z25FDJ12(□□□)
(With LED, fly-wheel diode1:"+")

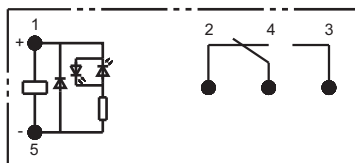

HF157F/□□□□-1Z25FDE2(□□□)
(With LED, RC circuit)

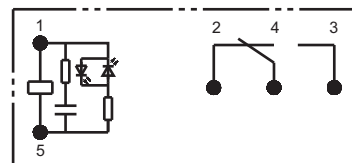

Outline Dimensions

HF157F/□□□□-1Z25FD1(□□□)

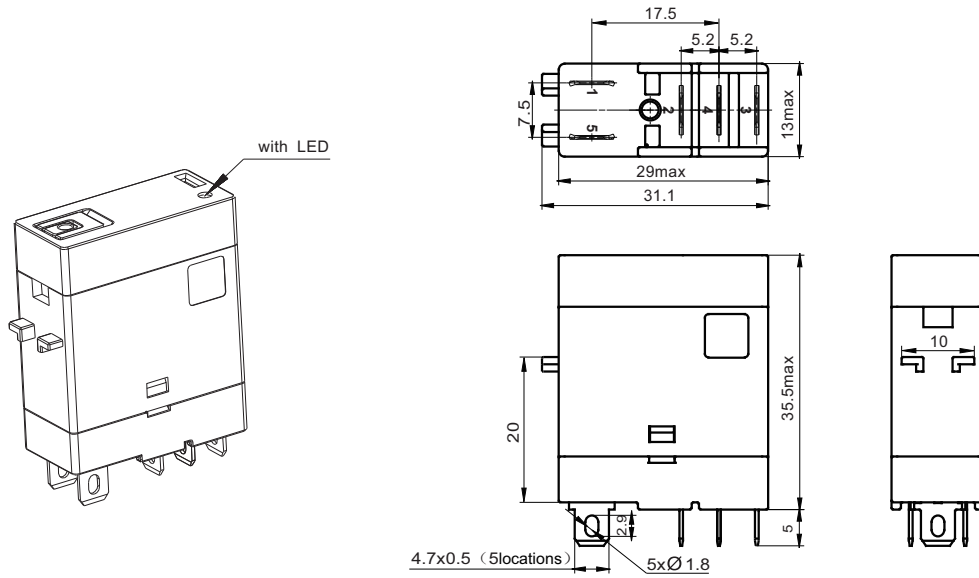

Wiring Diagram

(Bottom view)

HF157F/□□□□-1Z25FD1(□□□)
(With LED)

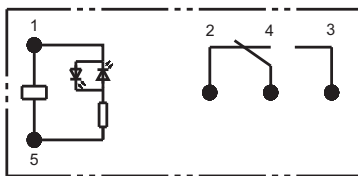

HF157F/□□□□-1Z25FDJ1(□□□)
(With LED, fly-wheel diode1:"-")

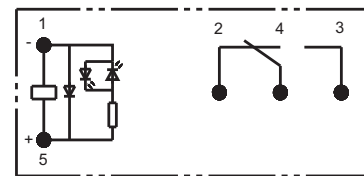

HF157F/□□□□-1Z25FDJ11(□□□)
(With LED, fly-wheel diode1:"+")

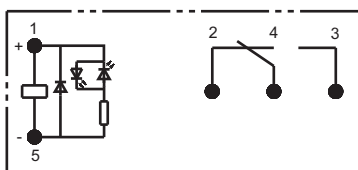

HF157F/□□□□-1Z25FDE1(□□□)
(With LED, RC circuit)

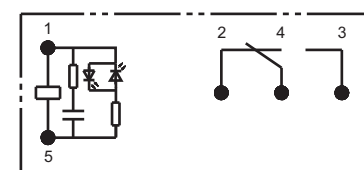

OUTLINE DIMENSIONS, WIRING DIAGRAM AND PC BOARD LAYOUT

Unit: mm

Outline Dimensions

HF157F/□□□□-2Z25FD2(□□□)

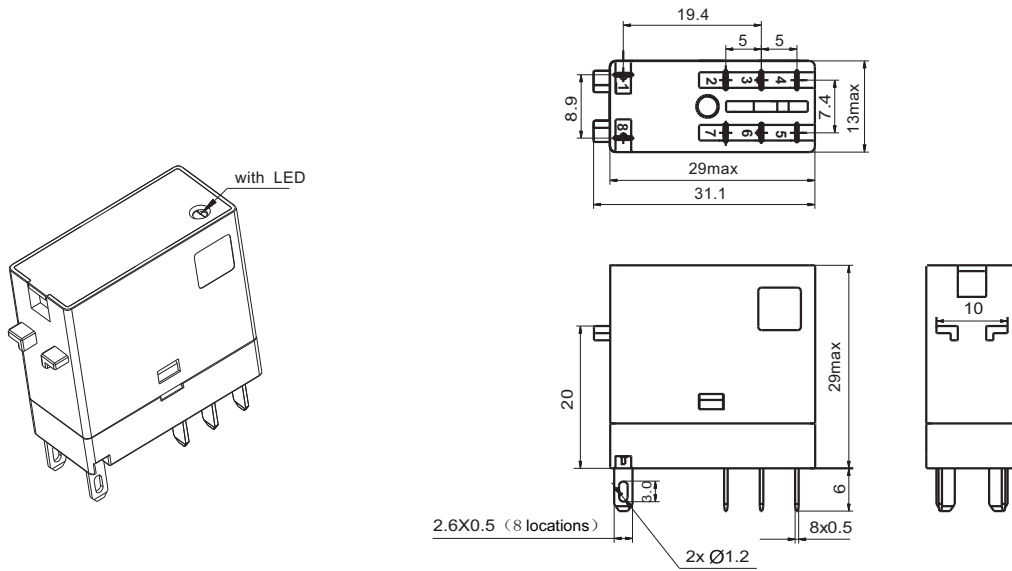

Wiring Diagram

(Bottom view)

HF157F/□□□□-2Z25FD2(□□□)
(With LED)

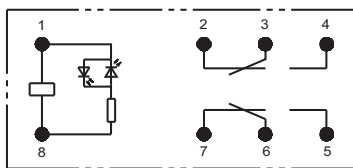

HF157F/□□□□-2Z25FDJ2(□□□)
(With LED, fly-wheel diode1:"-")

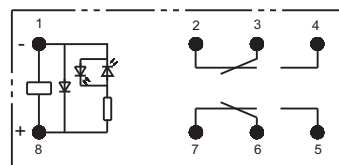

HF157F/□□□□-2Z25FDJ12(□□□)
(With LED, fly-wheel diode1:"+")

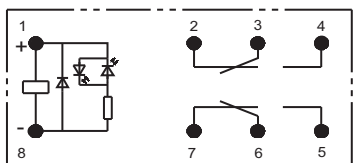

HF157F/□□□□-2Z25FDE2(□□□)
(With LED, RC circuit)

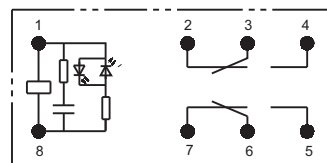

Outline Dimensions

HF157F/□□□□-2Z25FD1 (□□□)

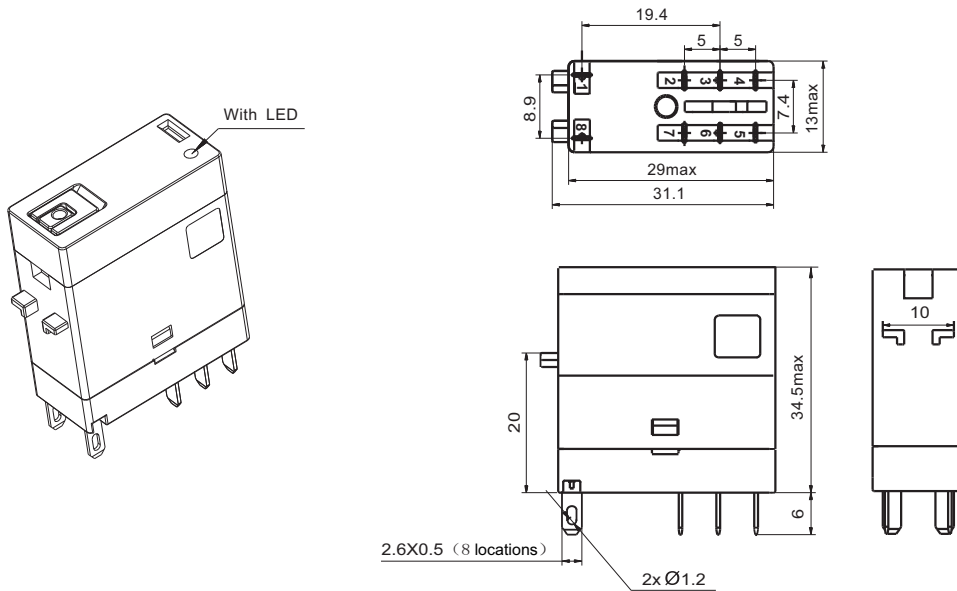

Wiring Diagram
(Bottom view)

HF157F/□□□□-2Z25FD1(□□□)
(With LED)

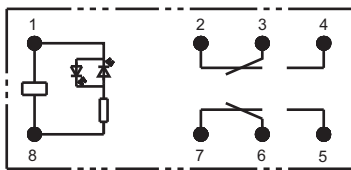

HF157F/□□□□-2Z25FDJ1(□□□)
(With LED, fly-wheel diode1:"-")

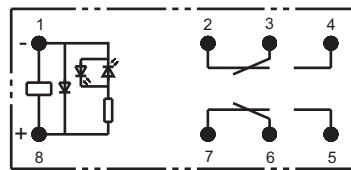

HF157F/□□□□-2Z25FDJ11(□□□)
(With LED, fly-wheel diode1:"+")

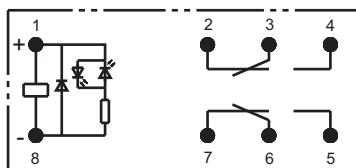

HF157F/□□□□-2Z25FDE1(□□□)
(With LED, RC circuit)

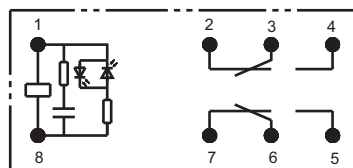

Remark:1) In case of no tolerance shown in outline dimension: outline dimension $\leq 1\text{mm}$, tolerance should be $\pm 0.2\text{mm}$; outline dimension $> 1\text{mm}$ and $\leq 5\text{mm}$, tolerance should be $\pm 0.3\text{mm}$; outline dimension $> 5\text{mm}$, tolerance should be $\pm 0.4\text{mm}$.
2) The tolerance without indicating for PCB layout is always $\pm 0.1\text{mm}$.

CHARACTERISTIC CURVES

ENDURANCE CURVE
(1Z)

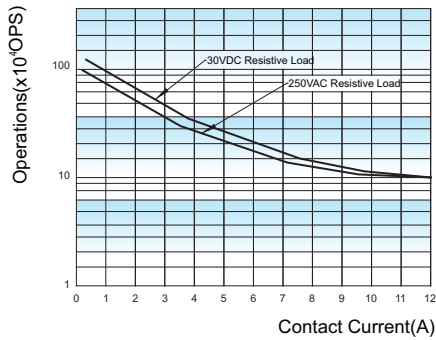

Test conditions:
NO or NC, Resistive Load, Room temp., 1s on 9s off.

ENDURANCE CURVE
(2Z)

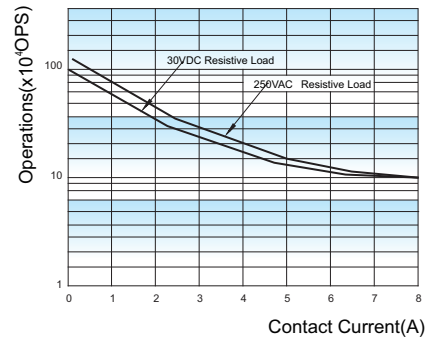

ENDURANCE CURVE
(1Z)

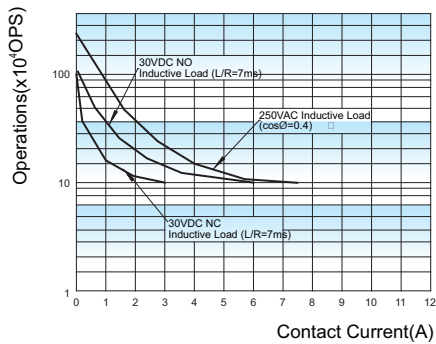

Test conditions:
NO or NC, Inductive Load, Room temp., 1s on 9s off.

ENDURANCE CURVE
(2Z)

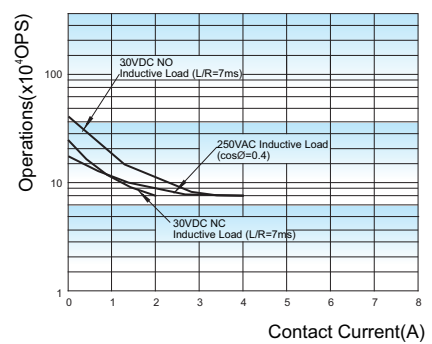

Relay Socket

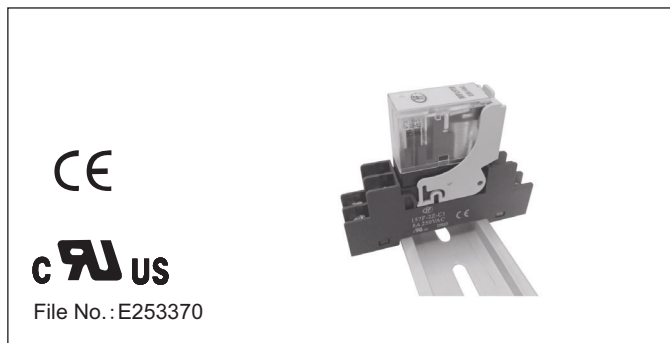

Features



- The dielectric strength can reach 4000VAC(I/O), and the insulation resistance is 1000MΩ
- Two mounting types are available: screw mounting and DIN rail mounting.
- Components available: plastic reainer(Collocation marker), metallic reainer.
- Applicable for:HF157F

CHARACTERISTICS

Type	Nominal Voltage	Nominal Current	Ambient Temperature	Dielectric Strength min.	Screw Torque	Wire Strip Length	Unit weight
157F-1Z-C2	250VAC/VDC	12A	-40 °C ~ 70 °C	4000VAC (Between coil & contacts)	1.0N · m	7mm	Approx.24.5g
				1000VAC (Homopolar contacts)			
				3000VAC (Heterospolar contacts)			
157F-2Z-C1	250VAC/VDC	8A/10A	-40 °C ~ 70 °C	4000VAC (Between coil & contacts)	1.0N · m	7mm	Approx.28g
				1000VAC (Homopolar contacts)			
				3000VAC (Heterospolar contacts)			

OUTLINE DIMENSIONS, WIRING DIAGRAM AND PC BOARD LAYOUT

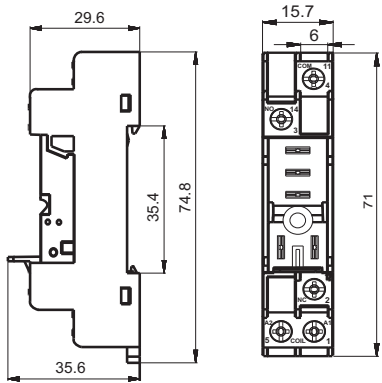
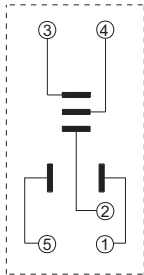
Unit: mm

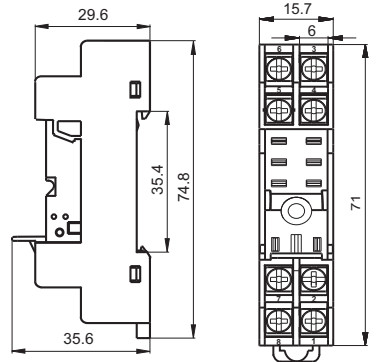
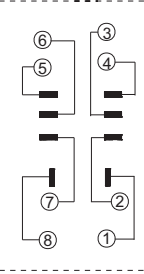
Socket	Outline Dimensions	Wiring Diagram / PCB Layout	Components Available
<p>157F-1Z-C2</p>  <p>DIN rail or Screw mounting</p>		 <p>(Top View)</p>	<p>plastic retainer 157F-H1 metallic retainer 157F-H2</p>
<p>157F-2Z-C1</p>  <p>DIN rail or Screw mounting</p>		 <p>(Top View)</p>	<p>plastic retainer 157F-H1 metallic retainer 157F-H2</p>

DIMENSION OF RELATED COMPONENT (AVAILABLE)

Unit: mm

Retainer

157F-H1(plastic retainer)

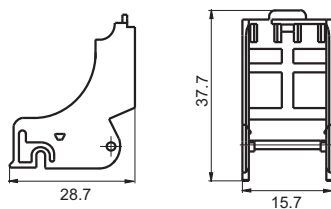

157F-H2 (metallic retainer)

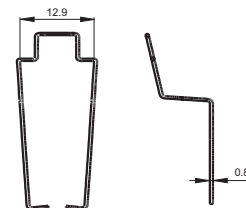

SELECTION OF PARTS

Type of Relay	Mounting termination	Socket	Retainer	Marker	Modules
HF157F/□ □ □ -1Z2□ □ □ 1	With button	157F-1Z-C2	157F-H1	14FF-M1	-
HF157F/□ □ □ -1Z2□ □ □ 2	Without button	157F-1Z-C2	157F-H1	14FF-M1	-
			157F-H2	-	
HF157F/□ □ □ -2Z2□ □ □ 1	With button	157F-2Z-C1	157F-H1	14FF-M1	-
HF157F/□ □ □ -2Z2□ □ □ 2	Without button	157F-2Z-C1	157F-H1	14FF-M1	-
			157F-H2	-	

Things to be noticed when selecting sockets:

1. Please choose suitable relay socket according to the actual mounting environment, relay contact poles and terminal layout. If there is any query on selection, please contact Hongfa for the technical service.
2. Socket which can be mounted with markers is furnished with a marker; as for other related components, they should be selected separately. Please do give clear indication of the types of relay sockets and related components you choose while placing order.
3. The above is only an example of typical socket and related component type which is suitable to HF157F relay. If you have any special requirements, please contact us.
4. Main outline dimension, outline dimension >50mm, tolerance should be $\pm 1\text{mm}$; $20\text{mm} < \text{outline dimension} \leq 50\text{mm}$, tolerance should be $\pm 0.5\text{mm}$; $5\text{mm} < \text{outline dimension} \leq 20\text{mm}$, tolerance should be $\pm 0.4\text{mm}$; outline dimension $\leq 5\text{mm}$, tolerance should be $\pm 0.3\text{mm}$.
5. DIN rail mounting: recommend to use standard rail $35 \times 7.5 \times 1$, $35 \times 15 \times 1$.

Disclaimer

The specification is for reference only. See to "Terminology and Guidelines" for more information. Specifications subject to change without notice. We could not evaluate all the performance and all the parameters for every possible application. Thus the user should be in a right position to choose the suitable product for their own application. If there is any query, please contact Hongfa for the technical service. However, it is the user's responsibility to determine which product should be used only.

© Xiamen Hongfa Electroacoustic Co., Ltd. All rights of Hongfa are reserved.