

## DETAILS

<b>Product Number</b>	FA11116_LXP-O-90
<b>Family</b>	Leila
<b>Type</b>	Assembly
<b>Color</b>	black
<b>Diameter</b>	21,6 mm
<b>Height</b>	14,7 mm
<b>Style</b>	round
<b>Optic Material</b>	PMMA
<b>Holder Material</b>	
<b>Fastening</b>	tape
<b>Status</b>	production ready
<b>ROHS Compliant</b>	Yes
<b>Date Updated</b>	4/02/2015



## OPTICAL PROPERTIES

LED	Viewing	Light	Effi-		Connector
	Angle	Beam	ciency	cd/lm	
XP-E	41+10 deg	O-90	89 %	5.300	-
XP-G	41+13 deg	O-90	91 %	4.700	-
XP-E-HEW	13+37 deg	O-90	-	-	-
XT-E	41+13 deg	O-90	85 %	4.200	-
XP-G2	13+39 deg	O-90	86 %	4.500	-
XP-L HI	41+12 deg	O-90	86 %	4.600	-
XP-E	sim: 9+43	O-90	sim: 92 %	sim: 6.500	-
XP-E2	sim: 9+43	O-90	sim: 91 %	sim: 6.600	-
LH351A(3535)	41+11 deg	O-90	89 %	5.400	-
Z5	38+21 deg	O-90	-	-	-

H G F E D C B A

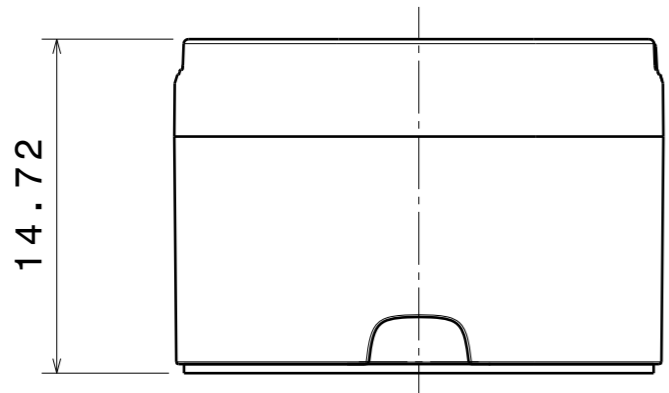

Front view

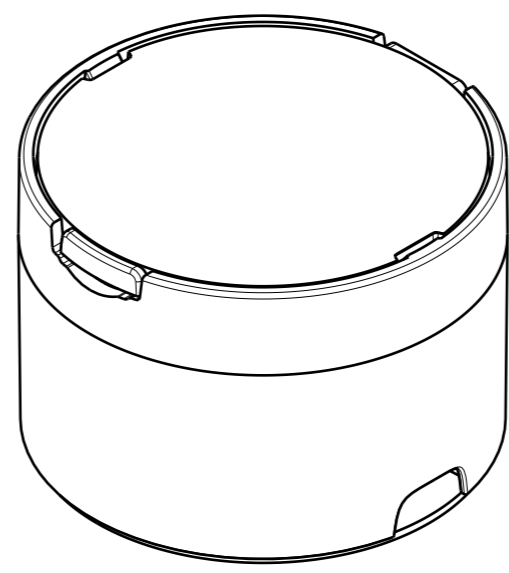

Isometric view

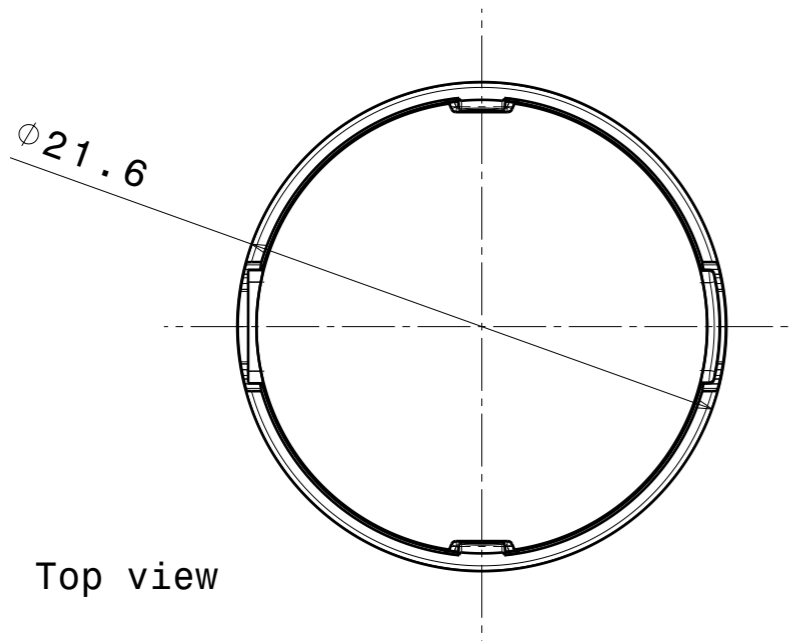

Top view

PU foam tape 0.4mm

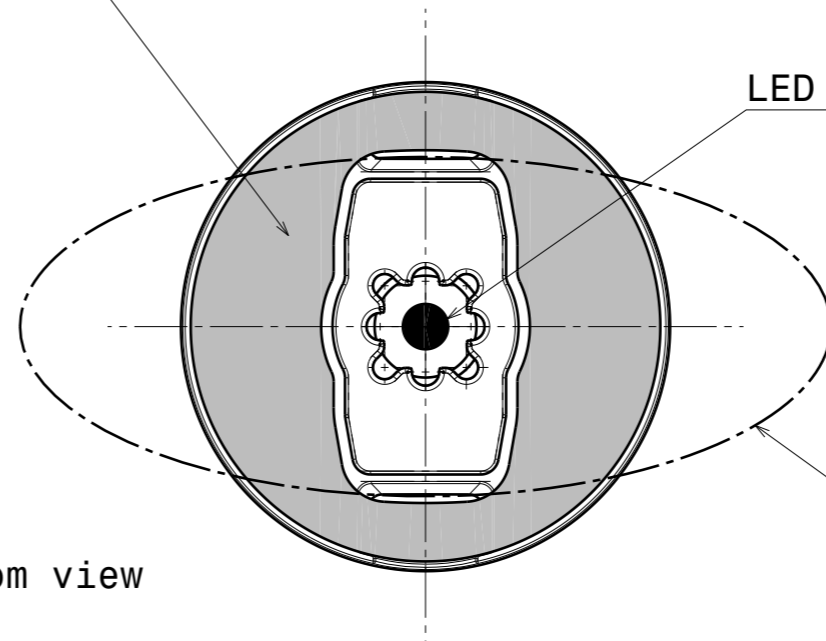

Bottom view

LED position

0-beam direction  
0-90 rotated 90 degrees

INDEX	DESCRIPTION	MATERIAL	COLOUR
1	Lens	PMMA	
2	Holder	PC	black

Tolerances if not otherwise shown  
According to DIN ISO 2768-1  
Linear measures:  
up to 30mm class M, otherwise class C  
According to DIN ISO 2768-2  
Form and position: class L

**LEDiL** LediL Oy  
Salorankatu 10  
FIN 24240 SALO  
Finland

THIRD ANGLE PROJECTION:

DRAWING TITLE  
**Datasheet\_LXP-Series**

This drawing is the property of LEDiL Oy. It may not be reproduced, copied or communicated without a written agreement with LEDiL Oy.

SIZE **A3** PART NUMBER -

SCALE 1:1 WEIGHT - SHEET 1/1

H G B A

Luminaire: LEDIL OY FA11116-LXP-O-90 (XP-G) Efficiency=91%  
Lamps: 1 x Cree XP-G (86lm@250mA)

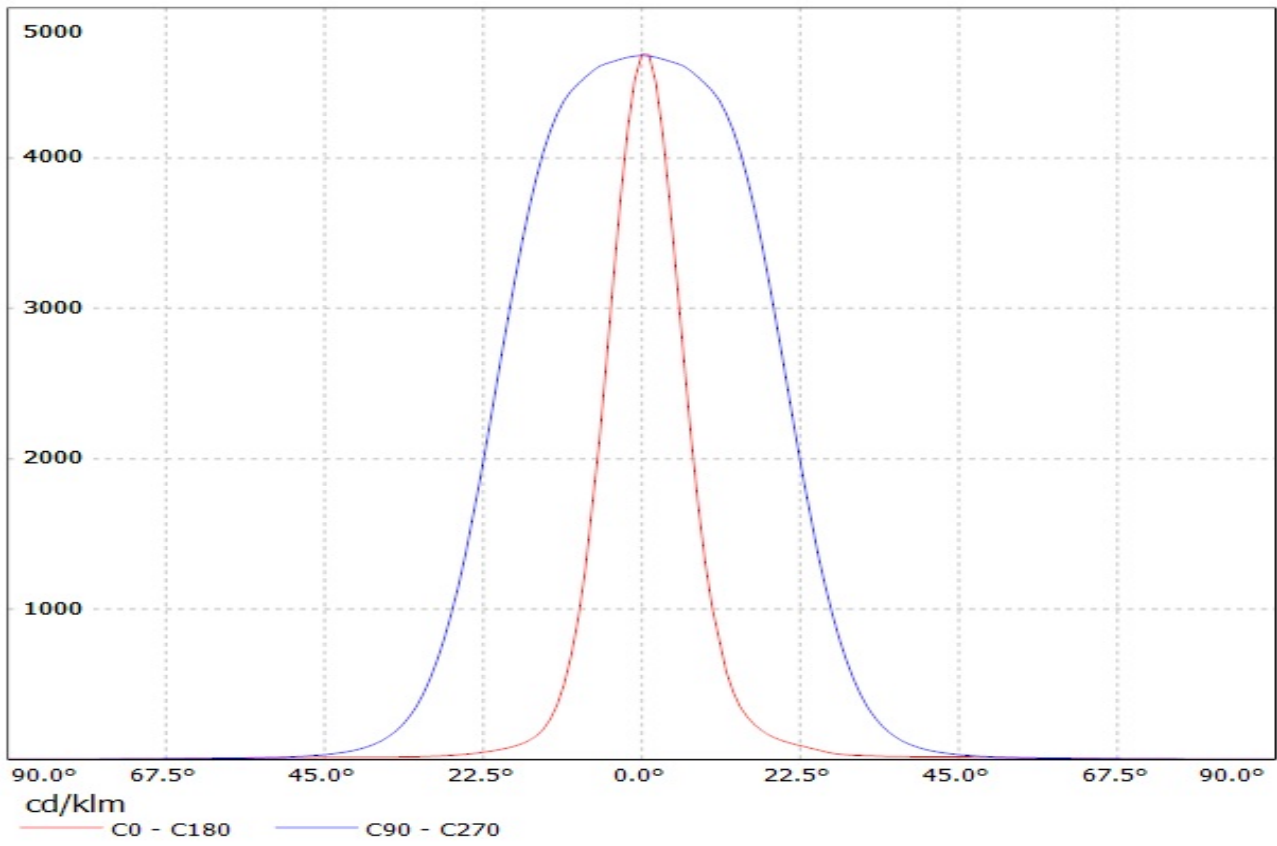

Luminaire: Ledil Oy FA11116\_LXP-O-90 (Cree XT-E 100lm @ 250mA) Efficiency=85%  
Lamps: 1 x Cree XT-E 100lm @ 250mA

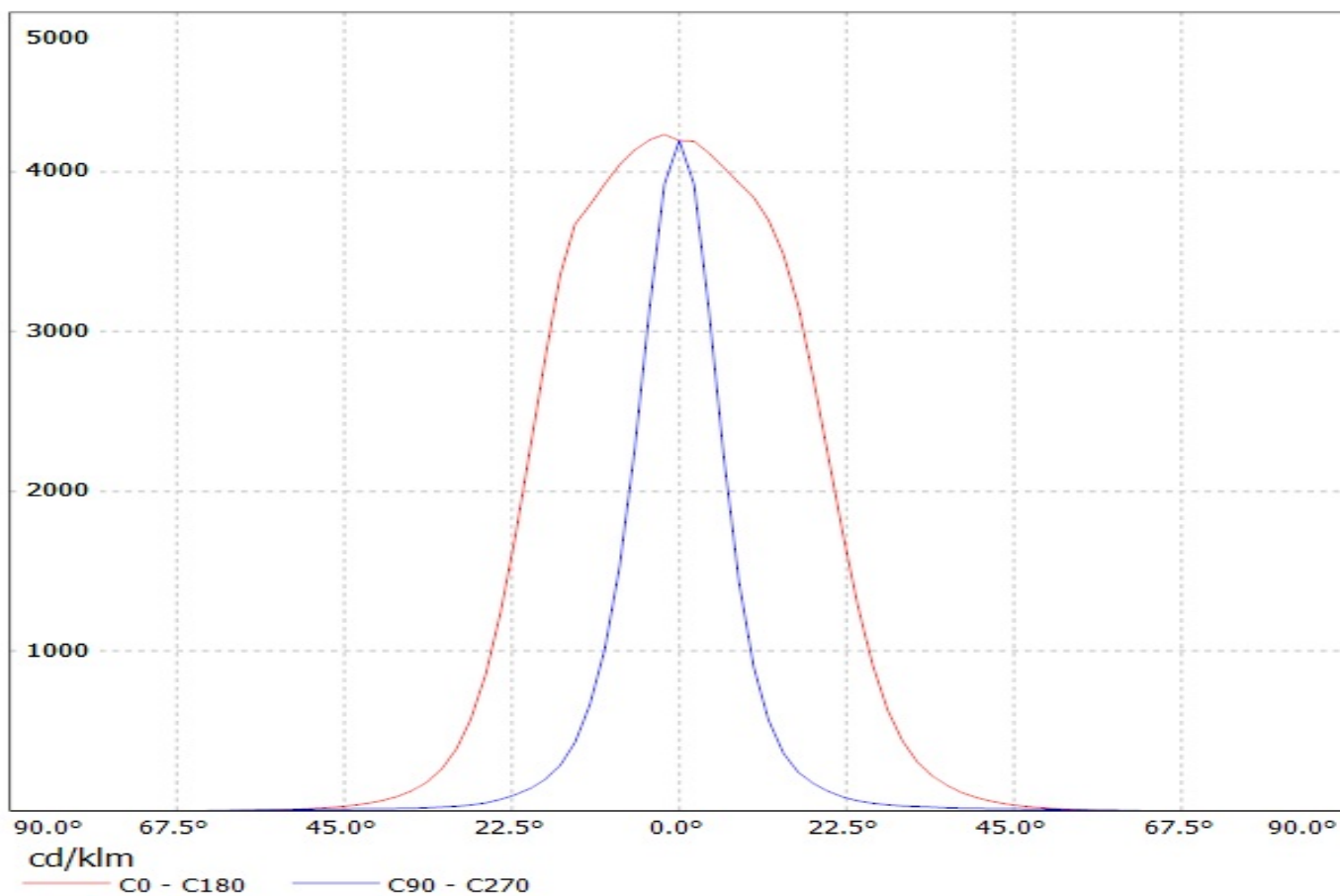

Luminaire: Ledil Oy FA11116\_LXP-O-90\_(XP-G2) Efficiency=86%  
Lamps: 1 x Cree XP-G2 (104lm @ 250mA) CCT=6600K P=0.8W I=250mA

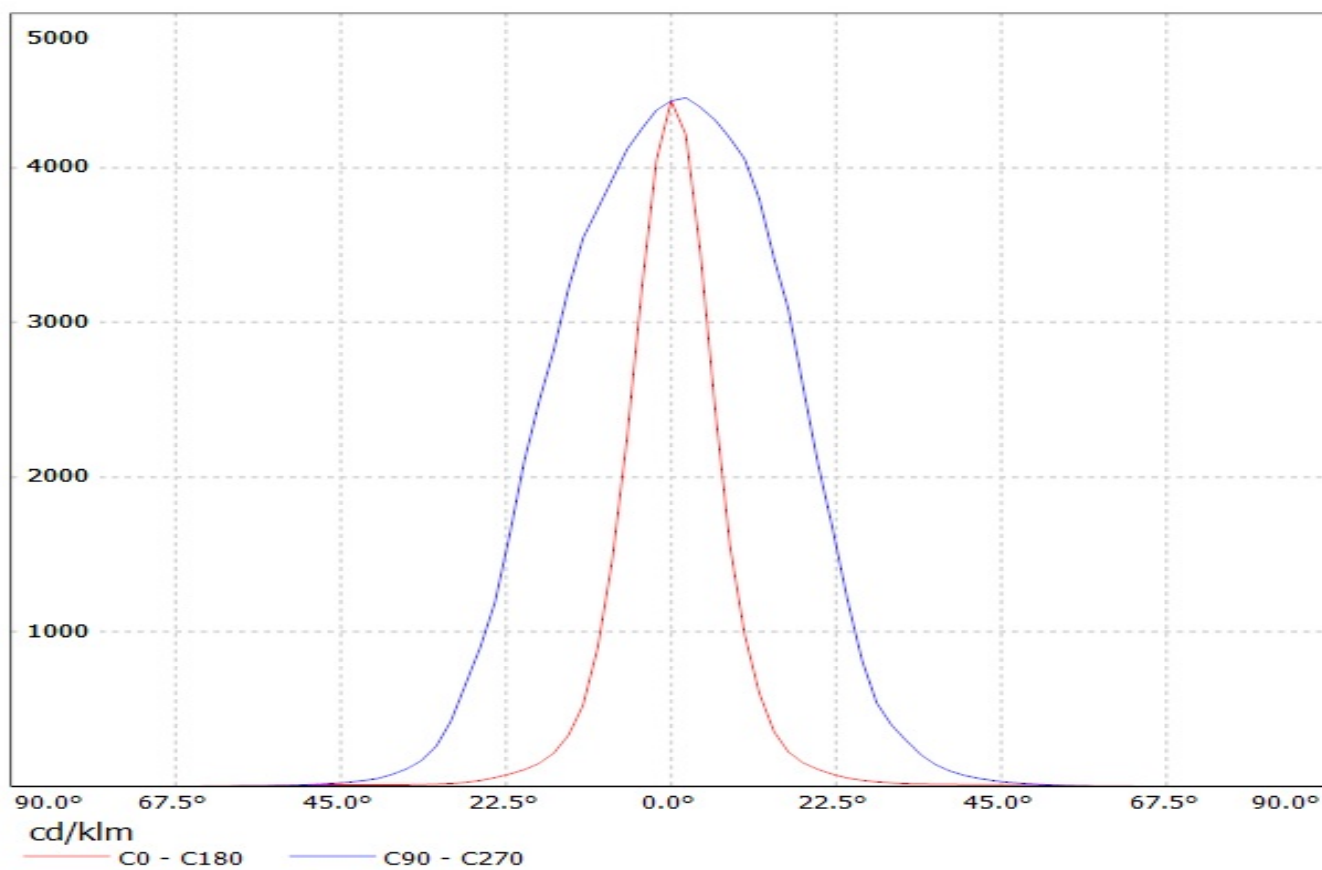

# Ledil FA11116\_LXP-O-90\_(XP-L\_HI) / LDC (Linear)

Luminaire: Ledil FA11116\_LXP-O-90\_(XP-L\_HI)

Lamps: 1 x CREE\_XP-L\_HI\_116.971lm@250mA\_P=0.75W\_I=0.25A

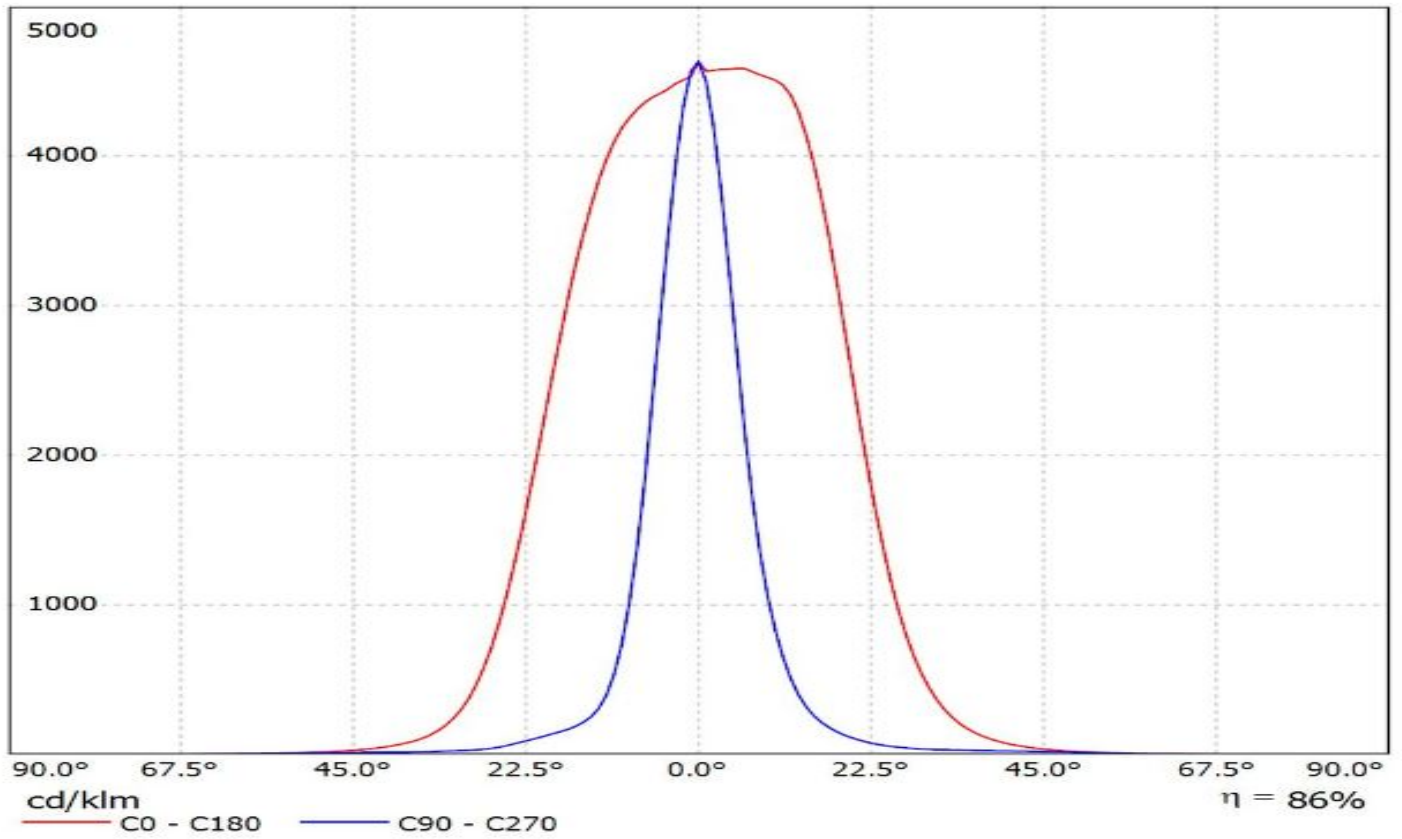

Luminaire: Ledil Oy FA11116\_LXP-O-90\_(XP-E)\_SIMULATED  
Lamps: 1 x Cree XP-E

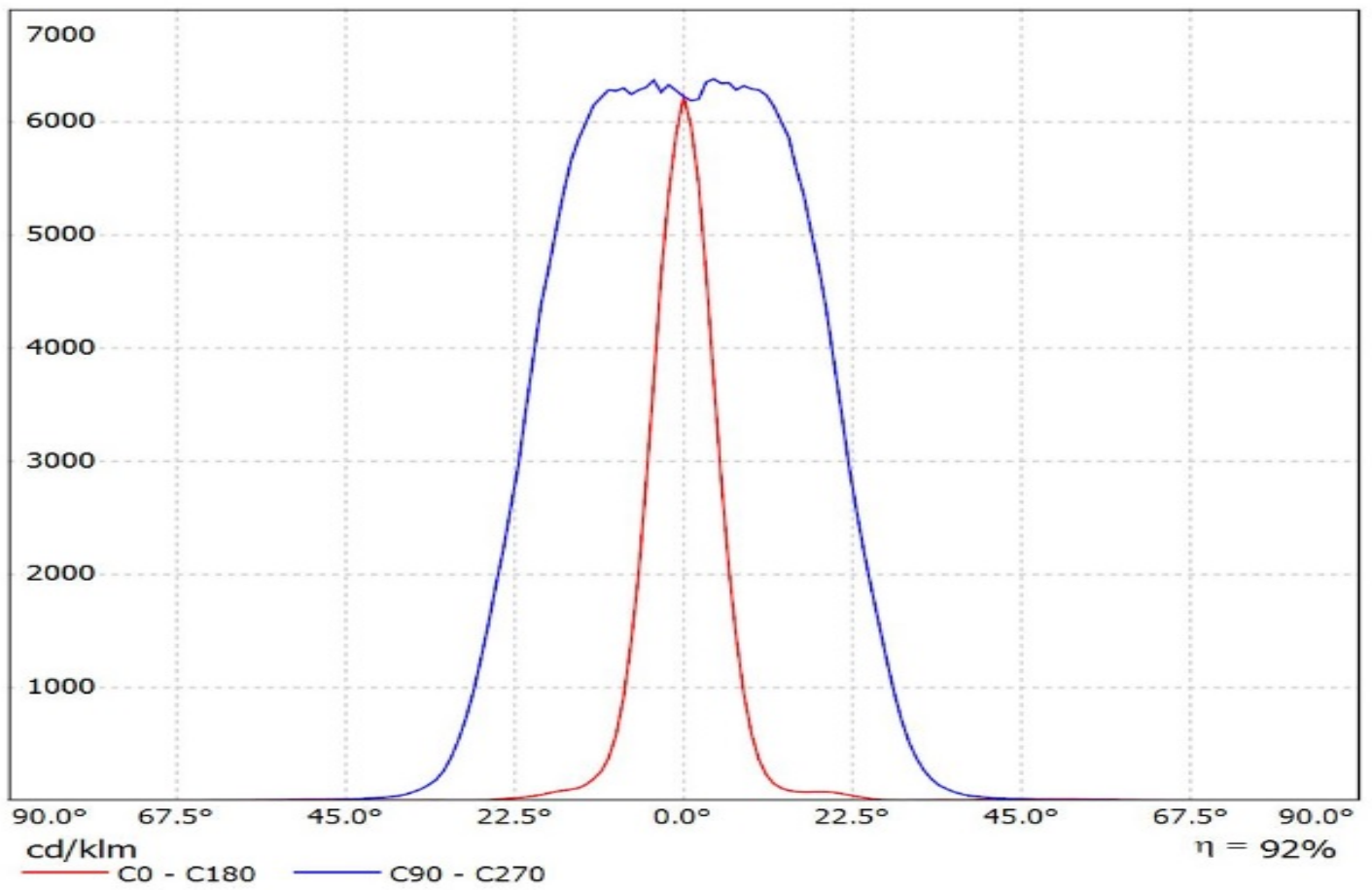

Luminaire: Ledil Oy FA11116\_LXP-O-90\_(XP-E2)\_SIMULATED  
Lamps: 1 x Cree XP-E2

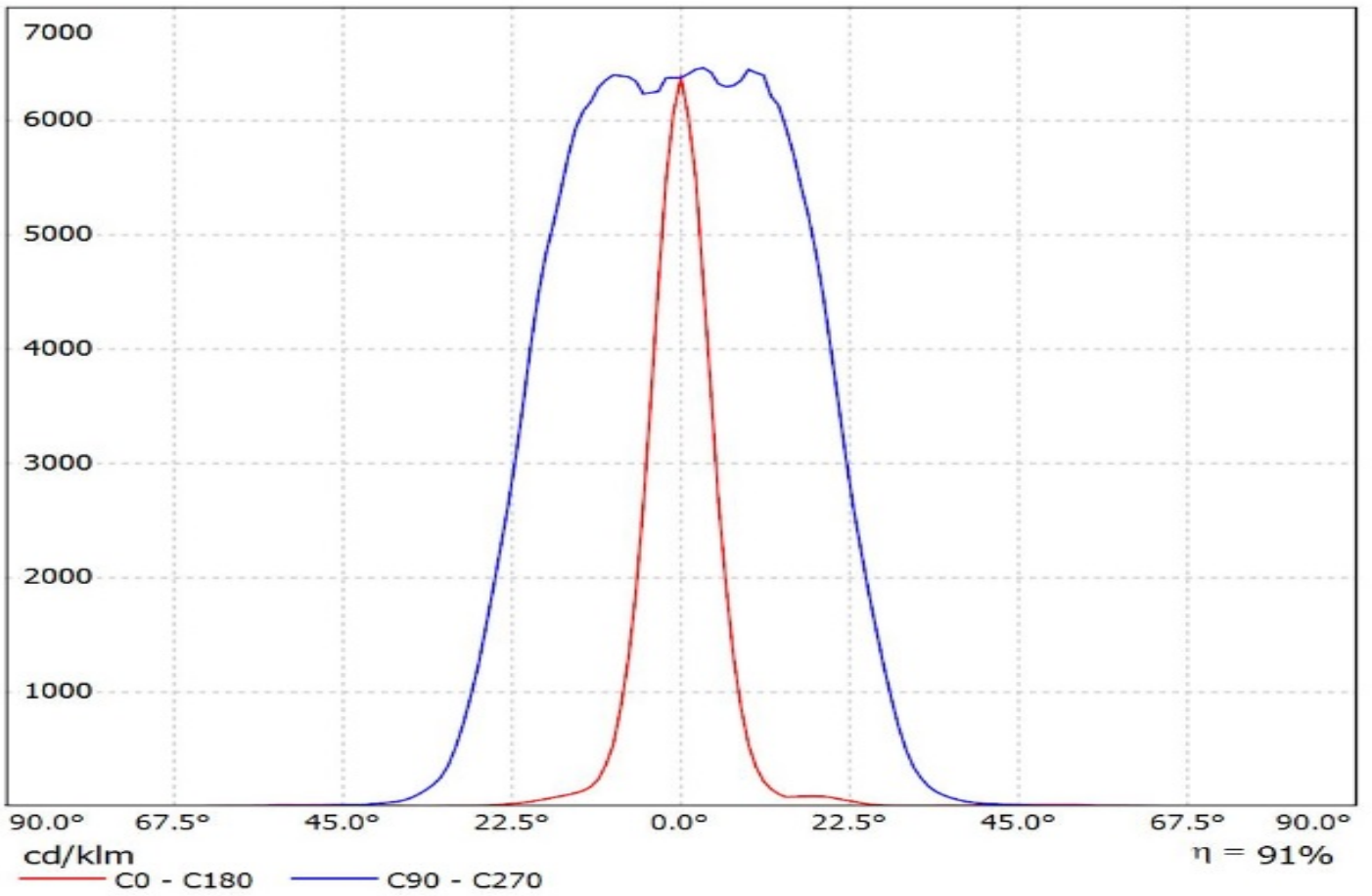



Luminaire: Ledil Oy FA11116\_LXP-O-90 (Samsung LH351A 86lm @ 250mA) Efficiency=89%  
Lamps: 1 x Samsung LH351A 86lm @ 250mA

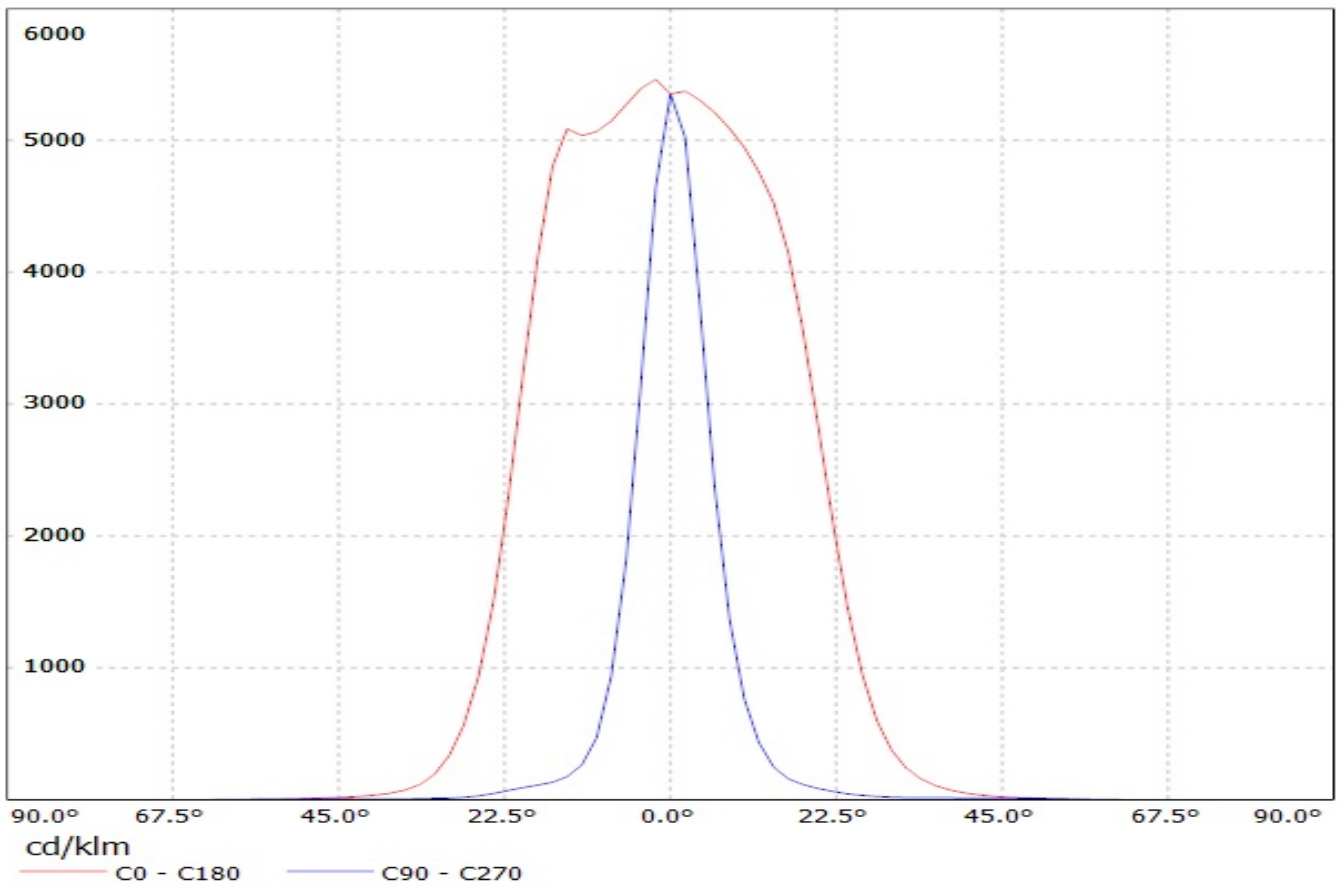

# Ledil Oy FA11116\_LXP-O-90 FA11116\_LXP-O-90 Cree XP-E LOR=89% / LDC (Polar)

Luminaire: Ledil Oy FA11116\_LXP-O-90 FA11116\_LXP-O-90 Cree XP-E LOR=89%  
Lamps: 1 x Cree XP-E

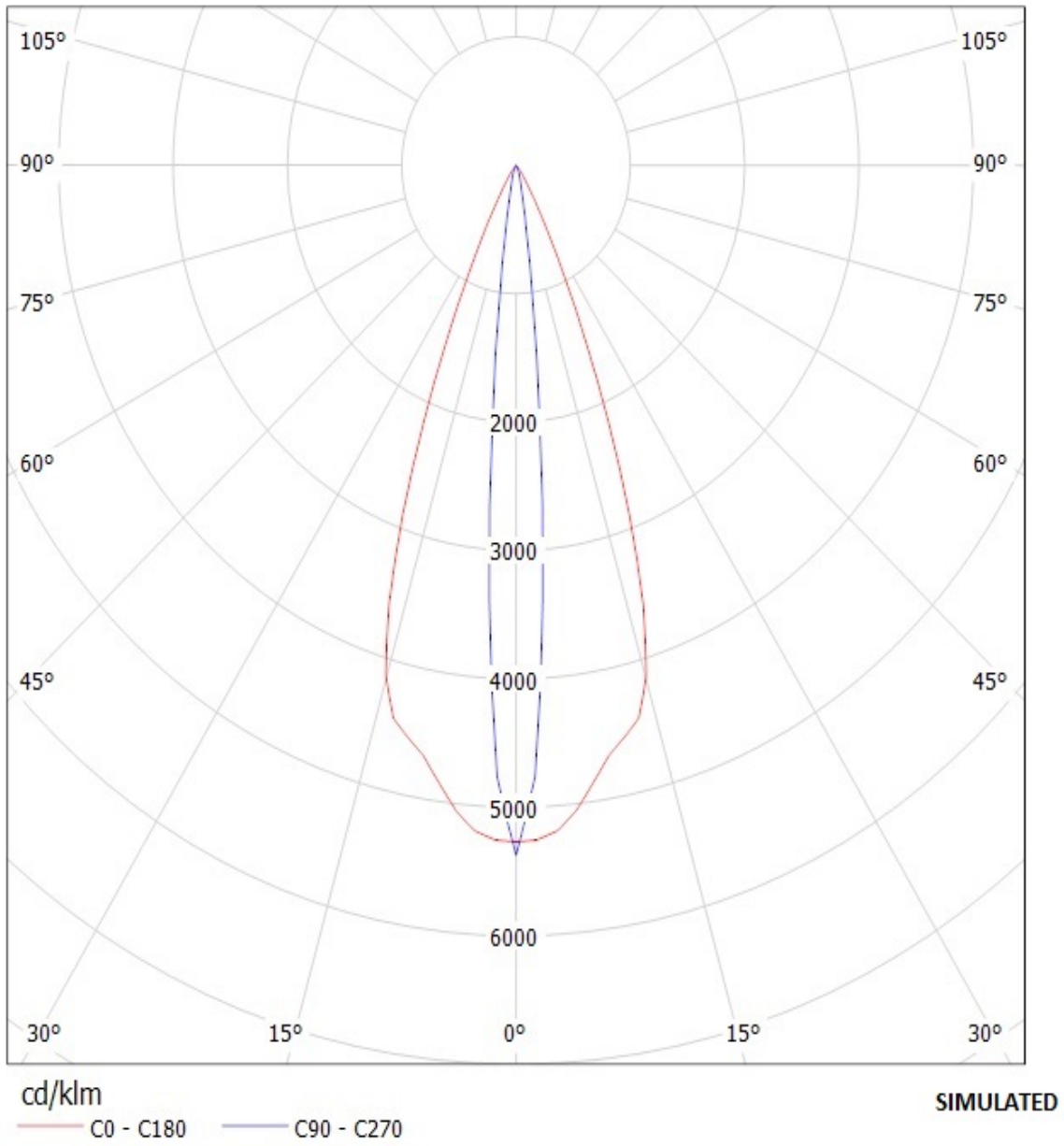

Luminaire: LEDIL OY FA11116-LXP-O-90 (XP-G) Efficiency=91%

Lamps: 1 x Cree XP-G (86lm@250mA)

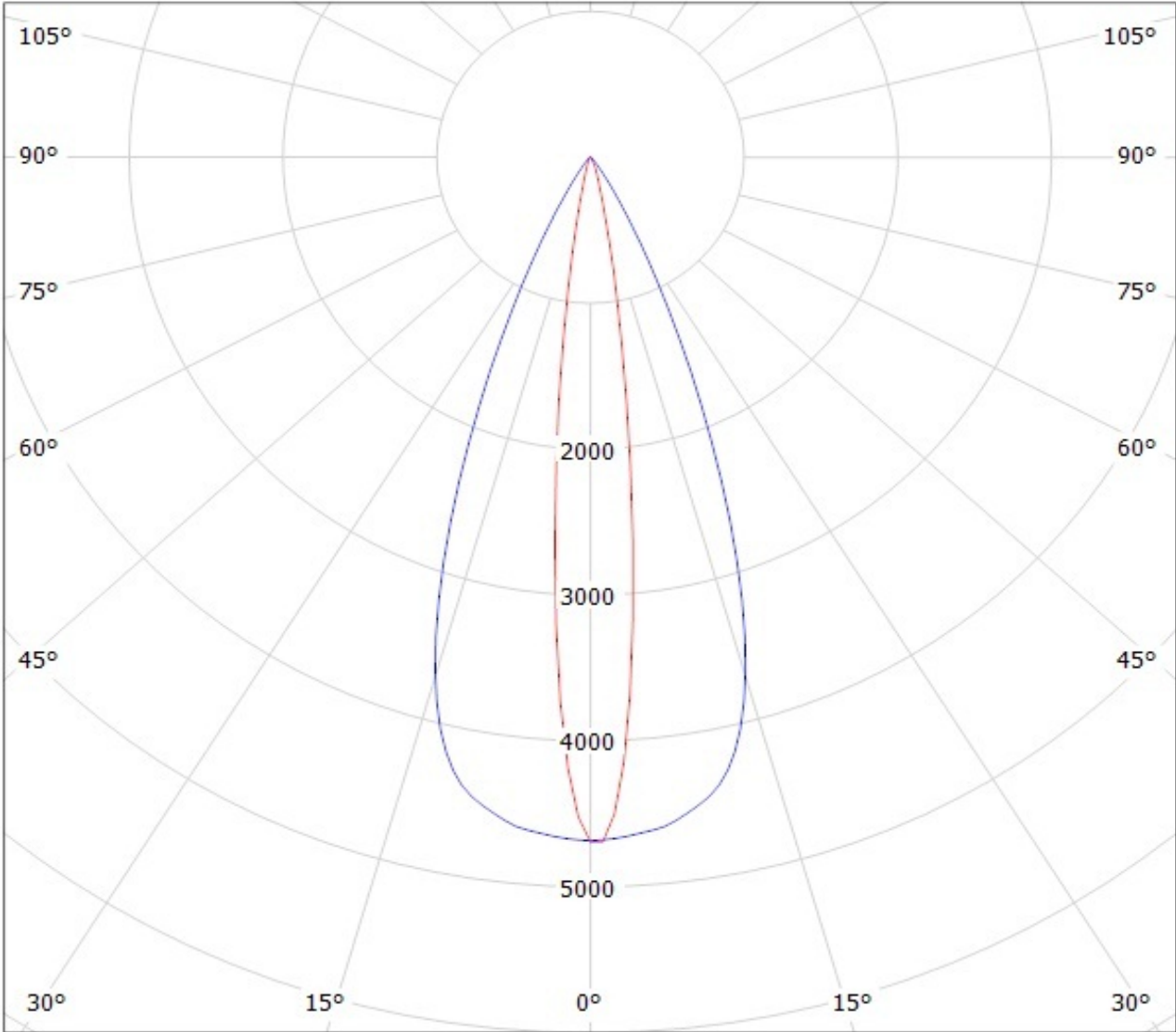

cd/klm

— C0 - C180    — C90 - C270

Luminaire: Ledil Oy FA11116\_LXP-O-90 (Cree XT-E 100lm @ 250mA) Efficiency=85%  
Lamps: 1 x Cree XT-E 100lm @ 250mA

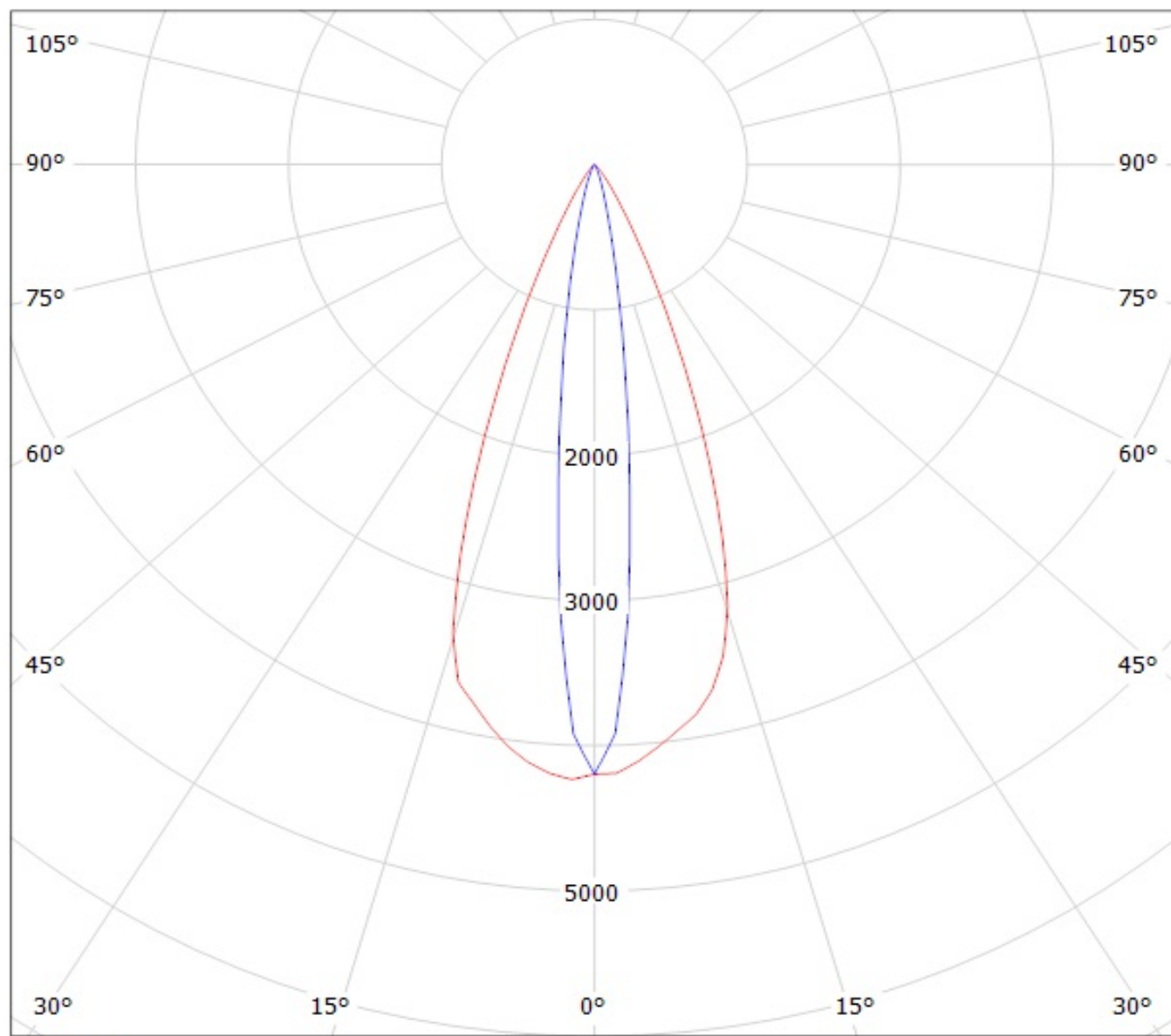

cd/klm

— C0 - C180    — C90 - C270

Luminaire: Ledil Oy FA11116\_LXP-O-90\_(XP-G2) Efficiency=86%  
Lamps: 1 x Cree XP-G2 (104lm @ 250mA) CCT=6600K P=0.8W I=250mA

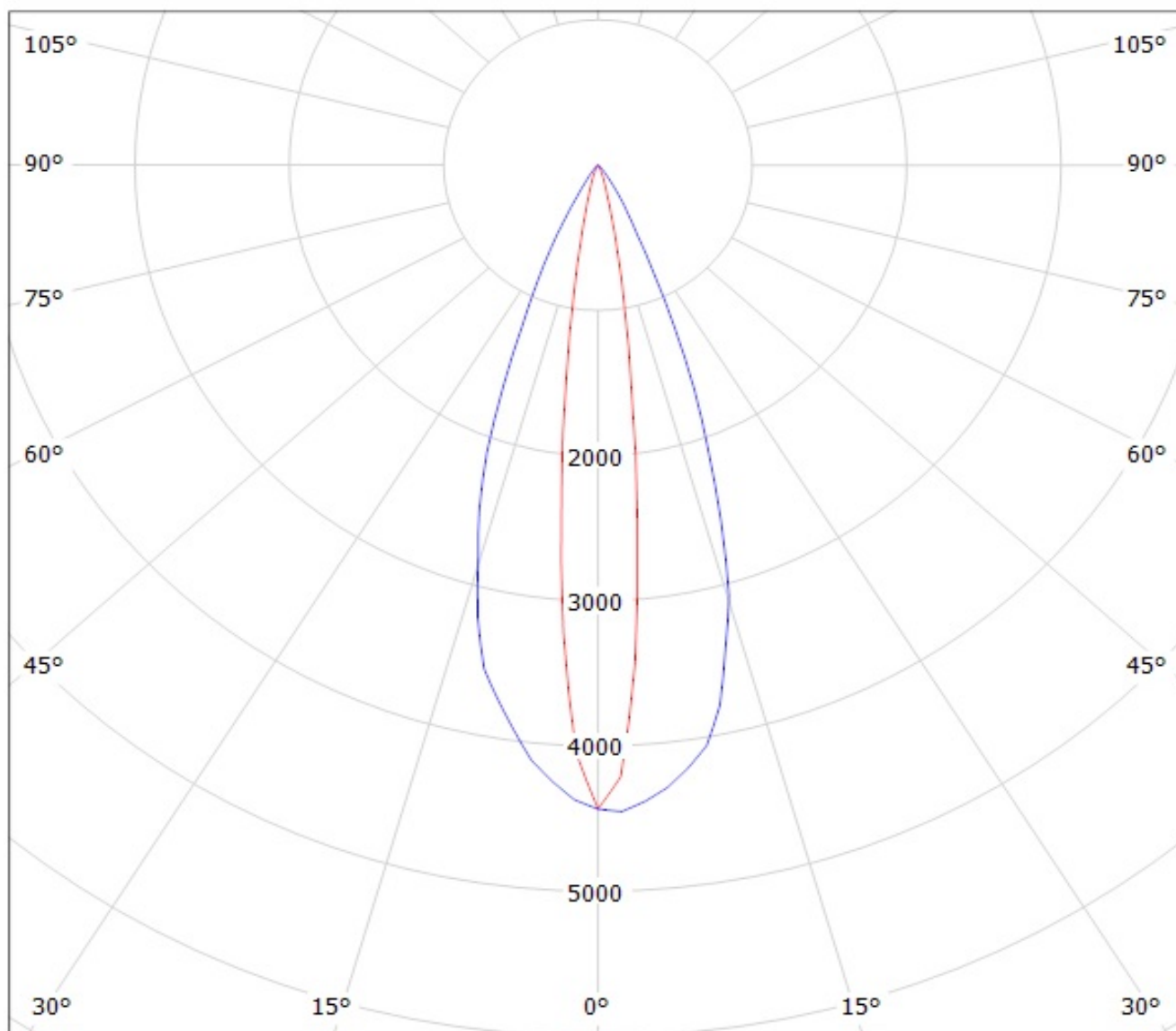

cd/klm

— C0 - C180    — C90 - C270

# Ledil FA11116\_LXP-O-90\_(XP-L\_HI) / LDC (Polar)

Luminaire: Ledil FA11116\_LXP-O-90\_(XP-L\_HI)

Lamps: 1 x CREE\_XP-L\_HI\_116.971lm@250mA\_P=0.75W\_I=0.25A

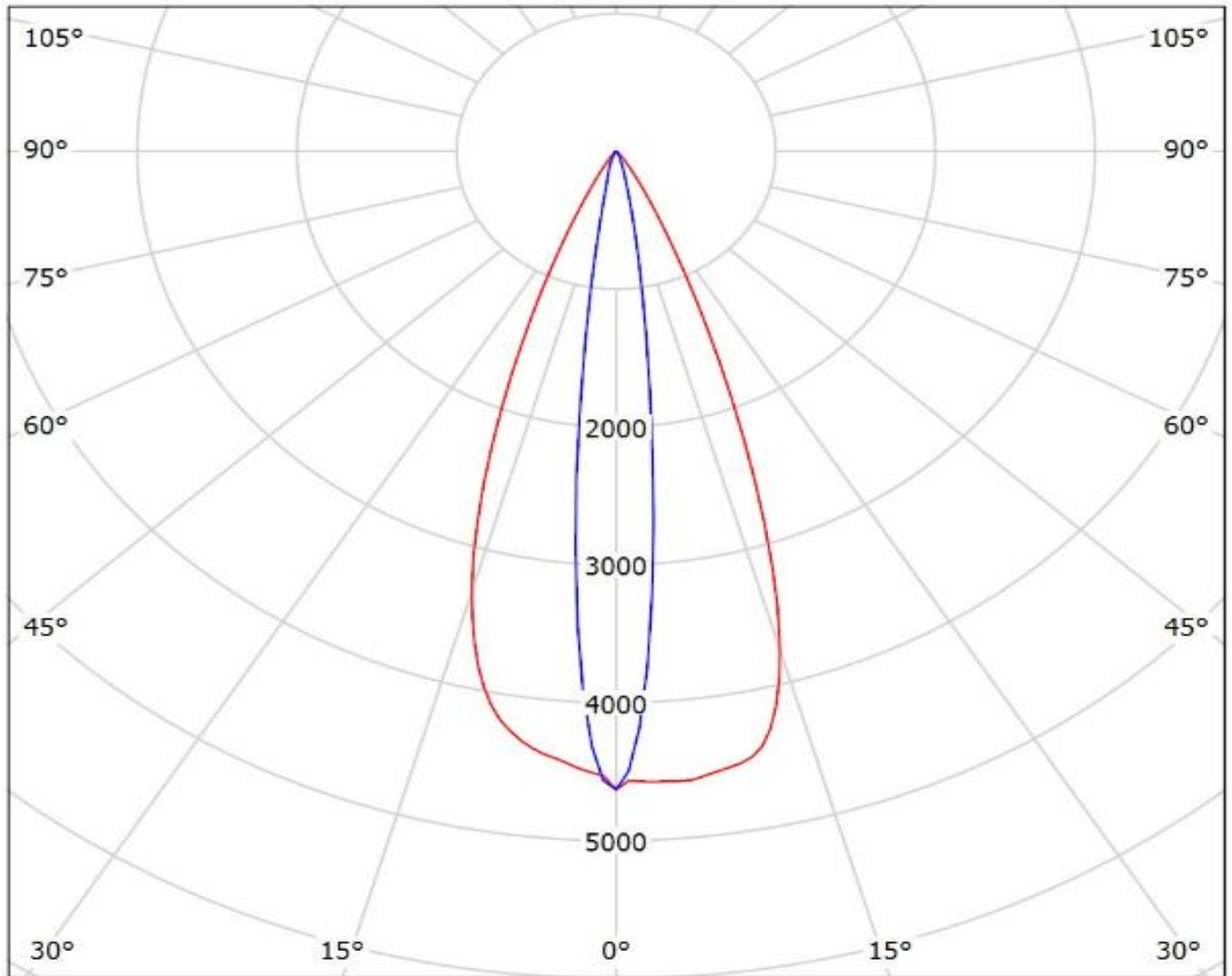

cd/klm

— C0 - C180 — C90 - C270

$\eta = 86\%$

Luminaire: Ledil Oy FA11116\_LXP-O-90\_(XP-E)\_SIMULATED  
Lamps: 1 x Cree XP-E

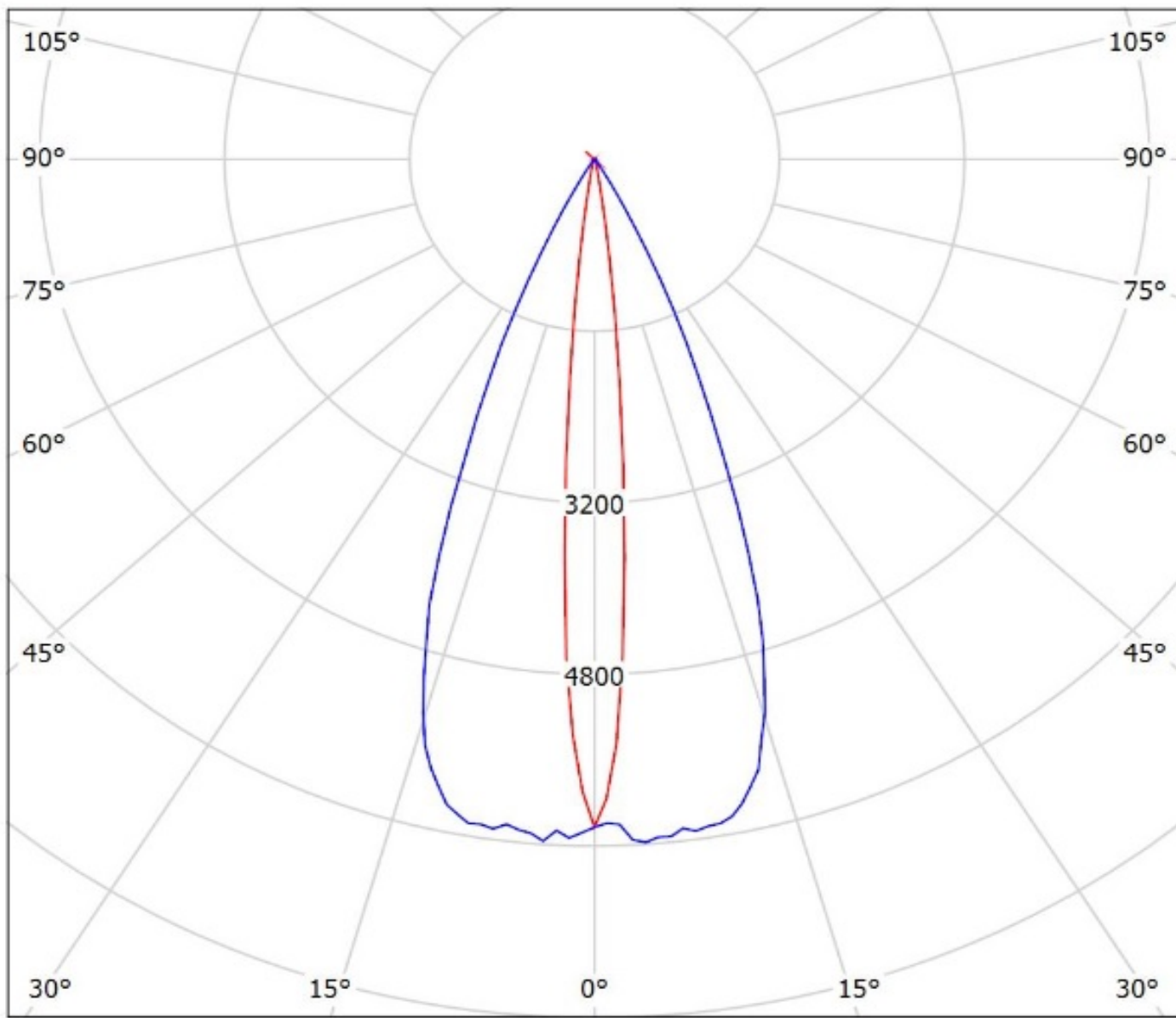

cd/klm  
— C0 - C180 — C90 - C270

$\eta = 92\%$



Luminaire: Ledil Oy FA11116\_LXP-O-90\_(XP-E2)\_SIMULATED  
Lamps: 1 x Cree XP-E2

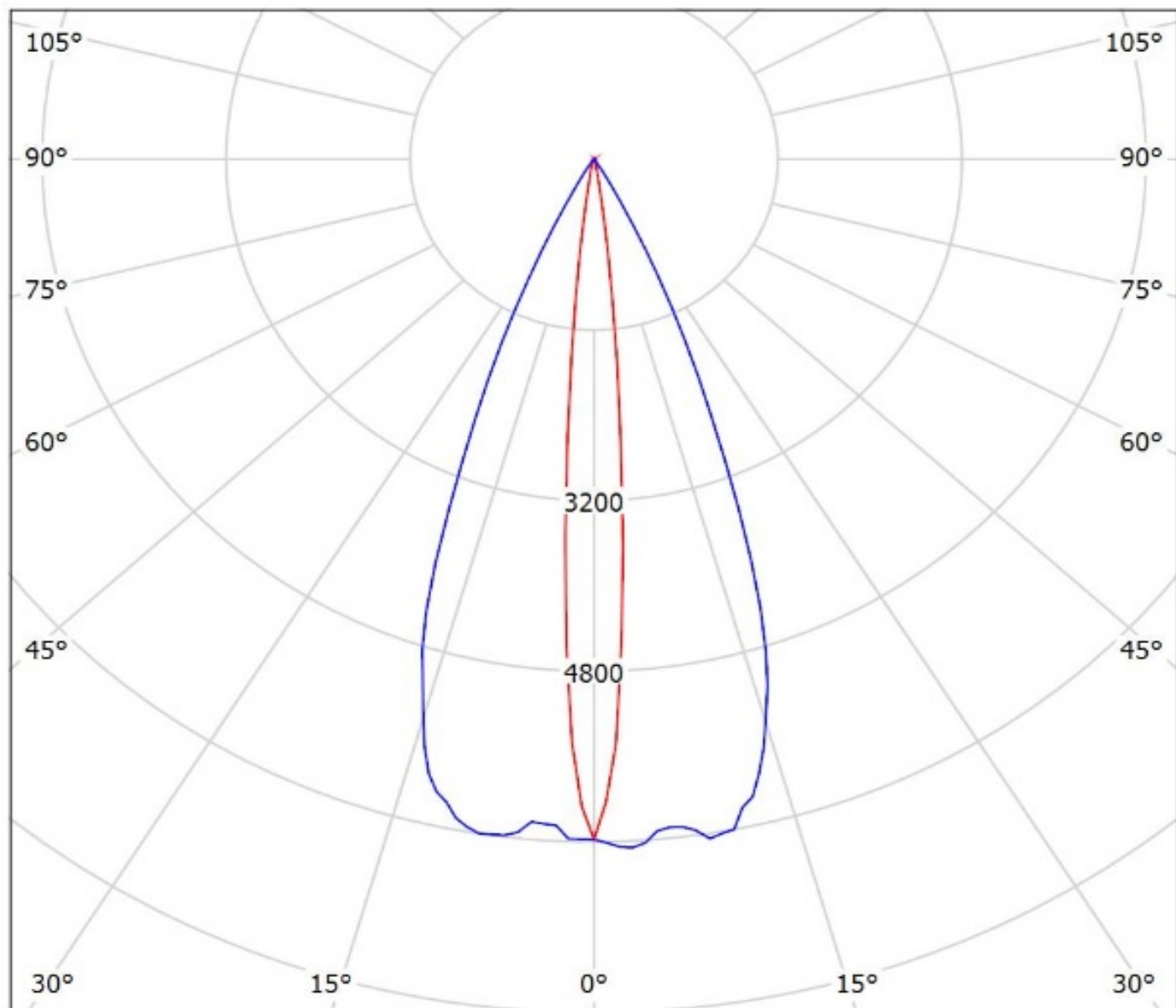

cd/klm

— C0 - C180 — C90 - C270

$\eta = 91\%$



Luminaire: Ledil Oy FA11116\_LXP-O-90 (Samsung LH351A 86lm @ 250mA) Efficiency=89%  
Lamps: 1 x Samsung LH351A 86lm @ 250mA

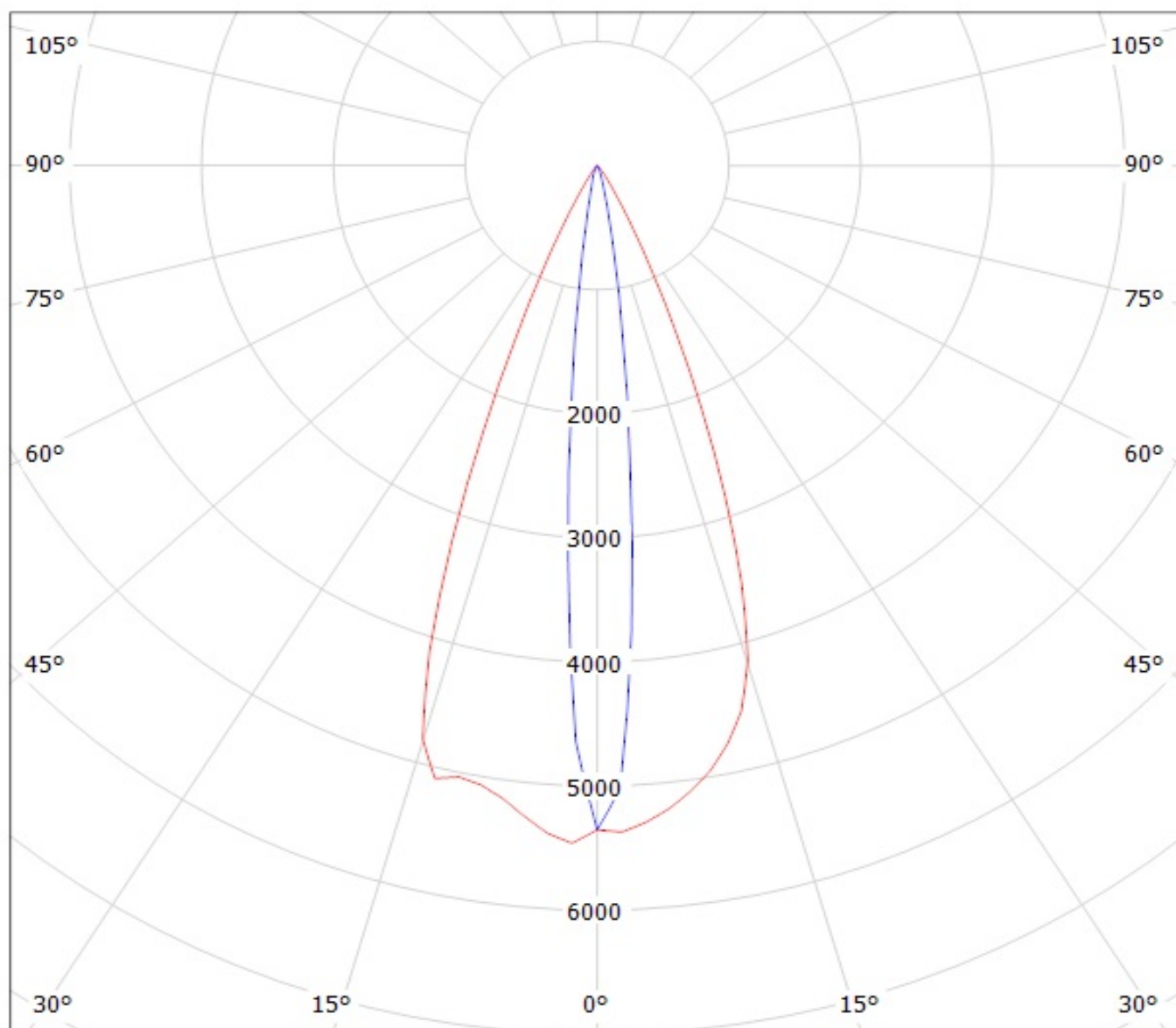

cd/klm

— C0 - C180

— C90 - C270

**NOTE: The typical divergence will be changed by different color, chip size and chip position tolerance. The typical total divergence is the full angle measured where the luminous intensity is half of the peak value.**