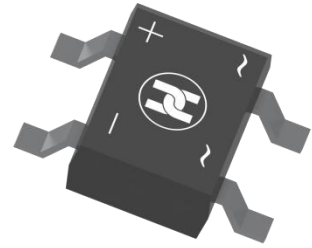
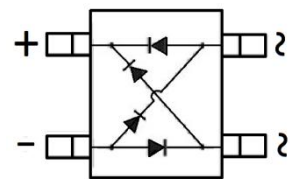

BRIDGE RECTIFIER
FEATURES

- Low Reverse voltage leakage current
- Glass Passivated Die Construction
- Low Forward Voltage Drop
- High forward surge current capability
- Small Surface Mount device

DBS

MECHANICAL DATA

- Case: DBS
- Case Material: Molded Plastic. UL flammability
- Classification Rating: 94V-0
- Weight: 0.40 grams (approximate)
- Marking: DBS102S

MAXIMUM RATINGS (T_A = 25°C unless otherwise noted)

Parameter	Symbol	Value	Unit
Repetitive peak reverse voltage	V _{RRM}	100	V
DC Reverse Voltage	V _R	100	V
RMS Reverse Voltage	V _{RMS}	70	V
Mean rectifying current	I _F	1	A
Non-Repetitive Peak Forward Surge Current @ t = 8.3 ms	I _{FSM}	50	A
Thermal Resistance From Junction To Ambient	R _{θJA}	40	°C/W
Junction Temperature	T _J	-55 ~ +150	°C
Storage Temperature	T _{STG}	-55 ~ +150	°C

ELECTRICAL CHARACTERISTICS (T_A = 25°C unless otherwise specified)

Parameter	Symbol	Min	Max	Unit	Conditions
Forward voltage	V _F		1.1	V	I _F =1A
Reverse current T=25°C	I _R		10	uA	V _R =100V
Reverse current T=125°C	I _R		500	uA	V _R =100V
Junction capacitance	C _J		25	pF	V=4V _{DC} , f=1MH

BRIDGE RECTIFIER

Typical Characteristics

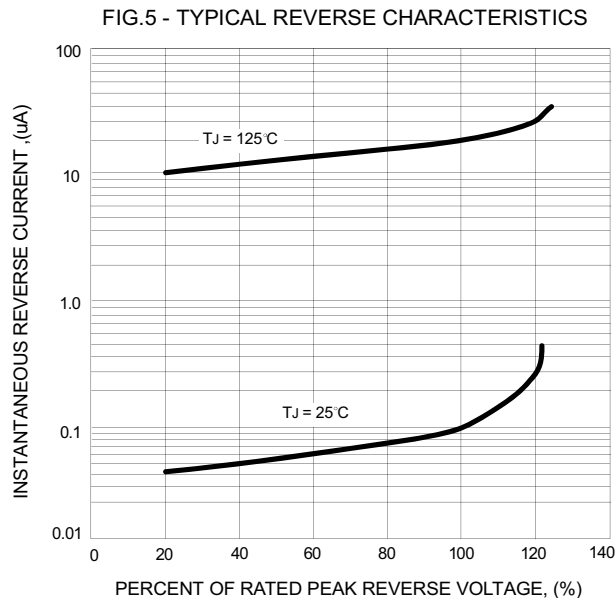
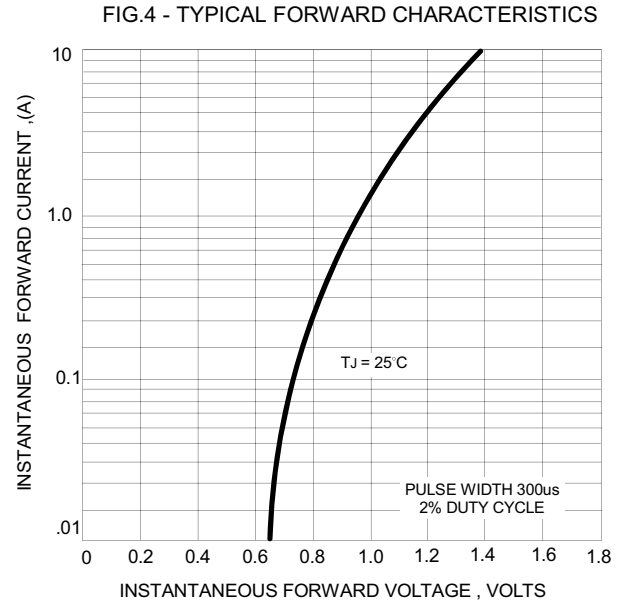
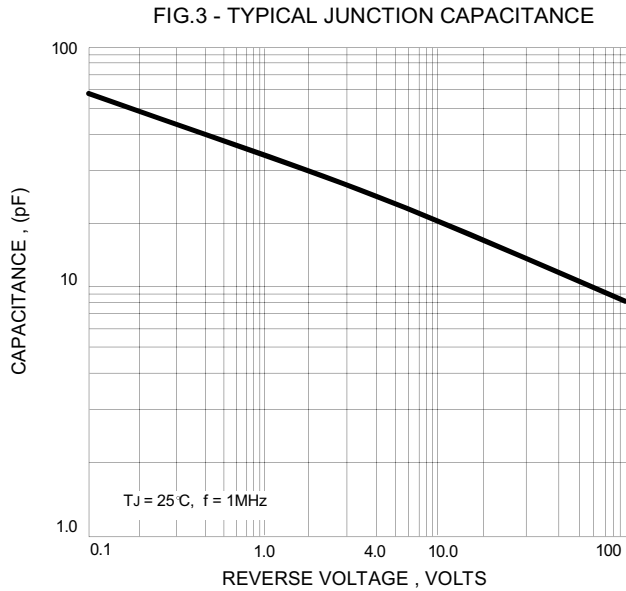
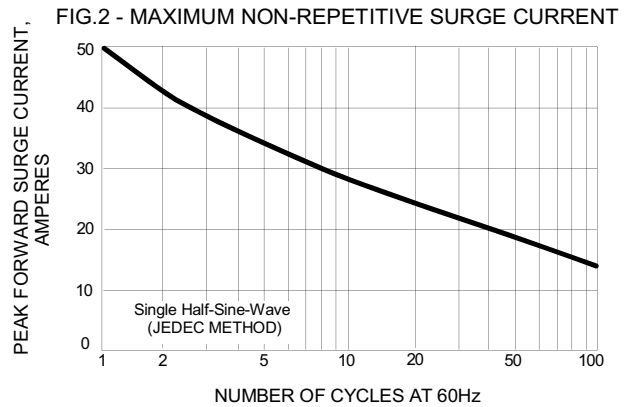
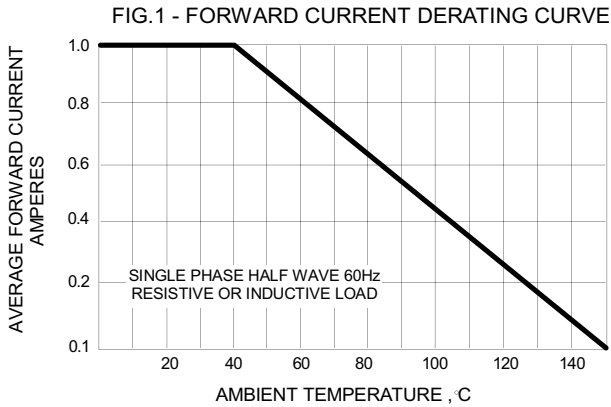

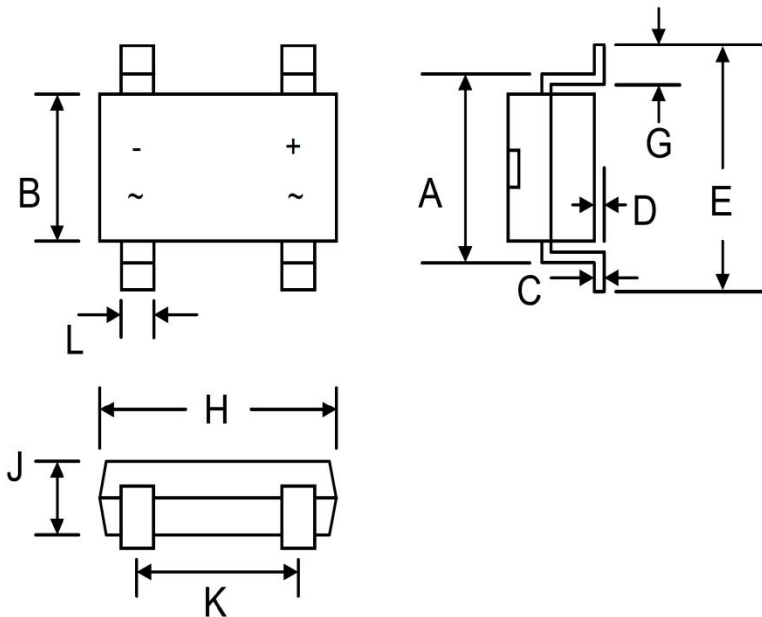
BRIDGE RECTIFIER
DBS Package Outline Dimensions

Symbol	Dimensions In Millimeters		Dimensions In Inches	
	Min.	Max.	Min.	Max.
A	7.40	7.90	0.189	0.209
B	6.20	6.50	0.165	0.181
C	0.25	-----	0.006	0.010
D	0.08	0.33	—	0.008
E	9.30	10.30	0.236	0.268
G	1.02	1.53	0.012	0.028
H	8.00	8.51	0.035	0.043
J	2.15	3.40	—	0.059
K	5.00	5.20	0.150	0.165
L	0.90	1.20	0.048	0.068

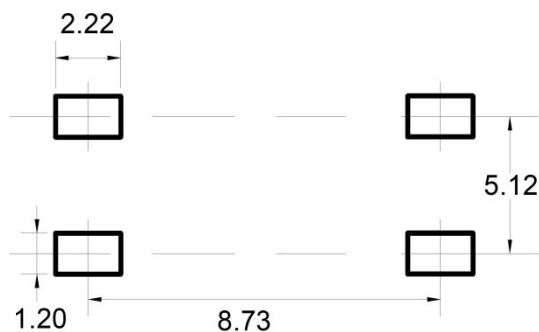
DBS Suggested Pad Layout

Note:

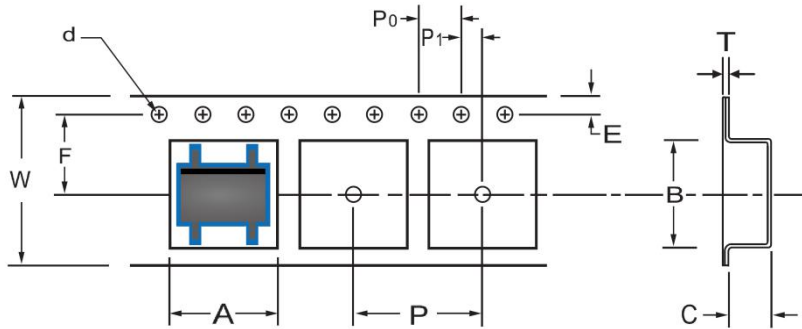
1. Controlling dimension: in millimeters
2. General tolerance: $\pm 0.05\text{mm}$
3. The pad layout is for reference purposes only

BRIDGE RECTIFIER
DBS Tape and Reel
DBS Embossed Carrier Tape

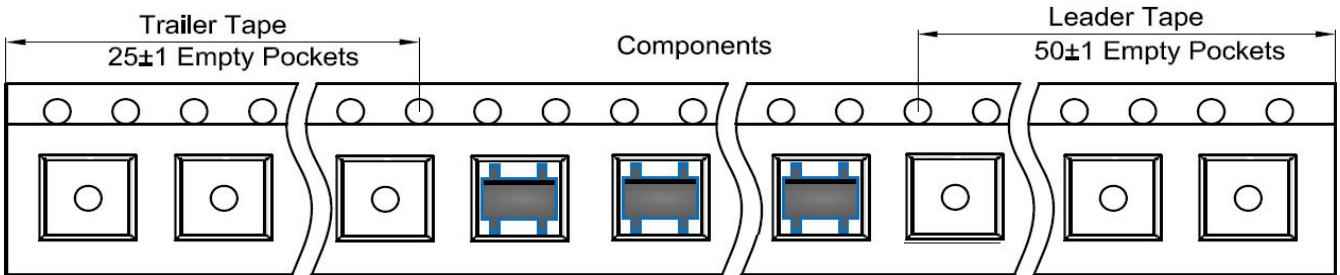
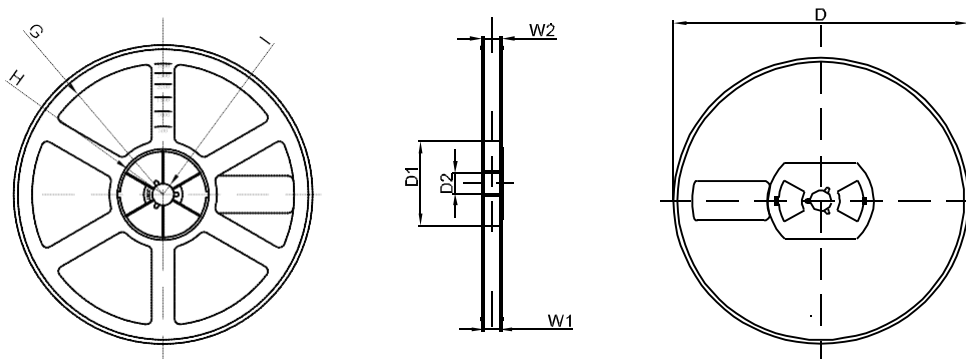
DIMENSIONS ARE IN MILLIMETER										
TYPE	A	B	C	d	E	F	P0	P	P1	W
DBS	8.64	10.41	3.50	Ø1.50	1.75	7.50	4.00	12.00	2.00	16.00
TOLERANCE	±0.1	±0.1	±0.1	±0.1	±0.1	±0.1	±0.1	±0.1	±0.1	±0.1

DBS Tape Leader and Trailer

DBS Reel

DIMENSIONS ARE IN MILLIMETER								
REEL OPTION	D	D1	D2	G	H	I	W1	W2
13" DIA	Ø330	100	21	R165	R50	R6.50	16.4	21.00
TOLERANCE	±2	±1	±1	±1	±1	±1	±1	±1