

## LNB VOLTAGE REGULATOR WITH I<sup>2</sup>C INTERFACE

 Check for Samples: [TPS65233](#)

### FEATURES

- Complete Integration Solution for LNB and I<sup>2</sup>C
- DiSEqC 1.x Compatible
- Supports 5-V and 12-V Power Bus
- Up to 1000-mA Accurate Output Current Limit Adjustable by External Resistor and I<sup>2</sup>C
- Boost Converter With Low R<sub>dson</sub> Internal Power Switch
- Dedicated Enable Pin for Non-I<sup>2</sup>C Application
- Low Noise, Low Drop Output With Push-Pull Output Stage
- Built-In Accurate 22-kHz Tone Generator or External Pin
- Adjustable Soft-Start and 13-V/18-V Voltage Transition Time
- Compliant with main satellite receiver systems Specifications
- LNB Short Circuit Dynamic Protection
- Diagnostics for Output Voltage Level, Input Supply UVLO, and DiSEqC Tone Output
- Cable Disconnect Diagnostic
- Available in a 16-Pin QFN 3-mm x 3-mm (RTE) Package

### APPLICATIONS

- Set Top Box Satellite Receiver
- TV Satellite Receiver
- PC Card Satellite Receiver

### DESCRIPTION/ORDERING INFORMATION

Designed for analog and digital satellite receivers, the TPS65233 is a monolithic voltage regulator with I<sup>2</sup>C interface, specifically to provide the 13-V/18-V power supply and the 22-kHz tone signaling to the LNB down-converter in the antenna dish or to the multi-switch box. It offers a complete solution with very low component count, low power dissipation together with simple design and I<sup>2</sup>C standard interfacing.

TPS65233 features high power efficiency. The boost converter integrates a 120-mΩ power MOSFET running at 500-kHz switching frequency. Drop out voltage at the linear regulator is 0.8 V to minimize power loss. TPS65233 provides multiple ways to generate the 22-kHz signal. Integrated linear regulator with push-pull output stage generates clean 22-kHz tone signal superimposed at the output even at zero loading. Current limit of linear regulator can be programmed by external resistor with ±10% accuracy. Full range of diagnostic read by I<sup>2</sup>C is available for system monitoring.

The part is available in a 16-pin QFN 3-mm x 3-mm (RTE) package.

### ORDERING INFORMATION<sup>(1)</sup>

T <sub>A</sub>	PACKAGE <sup>(2)</sup>		PART NUMBER	TOP-SIDE MARKING
-40°C to 85°C	16-Pin (QFN) - RTE	Reel of 2500	TPS65233RTE	TPS65233RTE

(1) For the most current packaging and ordering information, see the Package Option Addendum at the end of this document, or see the TI web site at [www.ti.com](http://www.ti.com).

(2) Package drawings, thermal data, and symbolization are available at [www.ti.com/packaging](http://www.ti.com/packaging).



Please be aware that an important notice concerning availability, standard warranty, and use in critical applications of Texas Instruments semiconductor products and disclaimers thereto appears at the end of this data sheet.



This integrated circuit can be damaged by ESD. Texas Instruments recommends that all integrated circuits be handled with appropriate precautions. Failure to observe proper handling and installation procedures can cause damage.

ESD damage can range from subtle performance degradation to complete device failure. Precision integrated circuits may be more susceptible to damage because very small parametric changes could cause the device not to meet its published specifications.

**FUNCTIONAL BLOCK DIAGRAM**

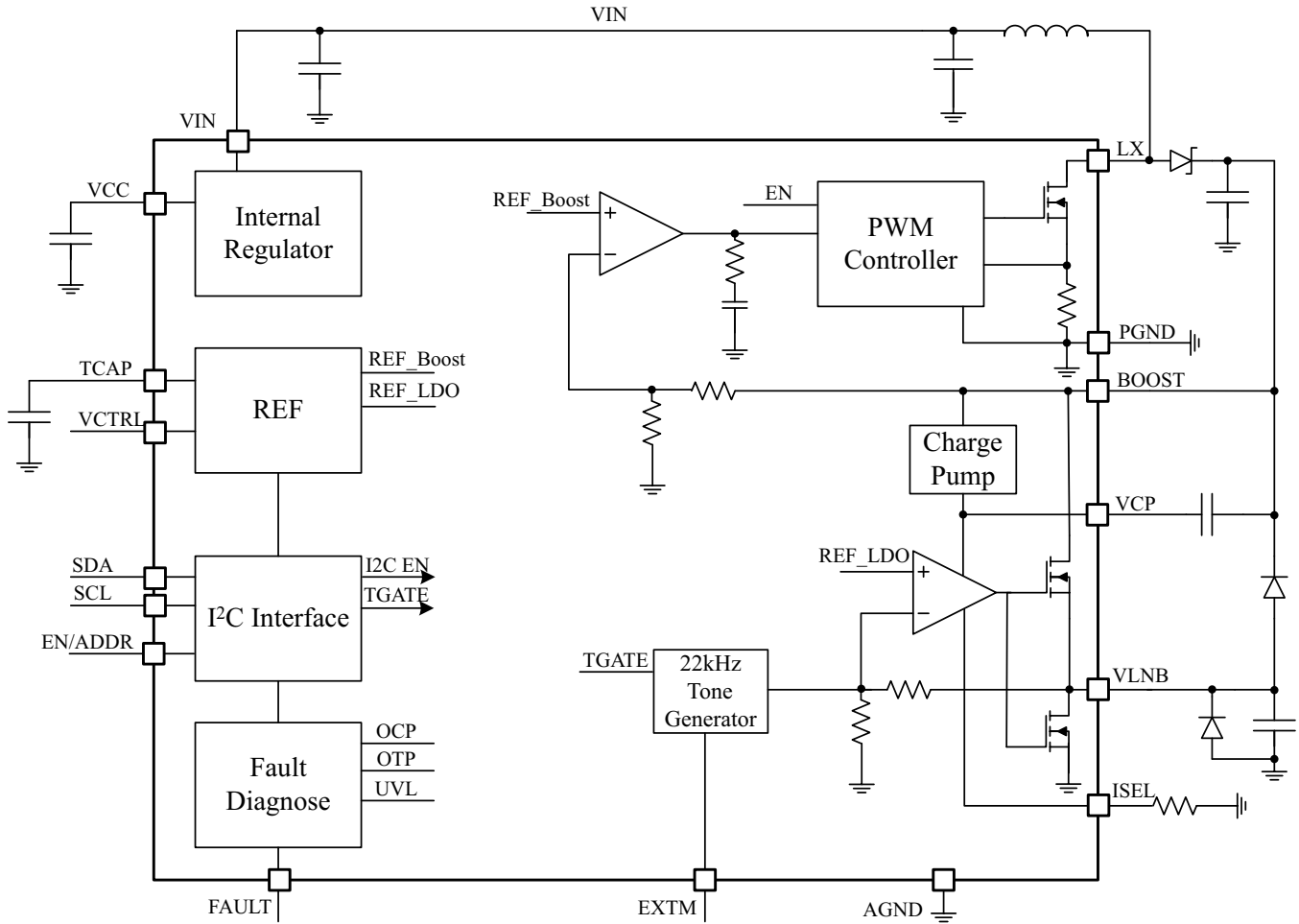

TYPICAL APPLICATION

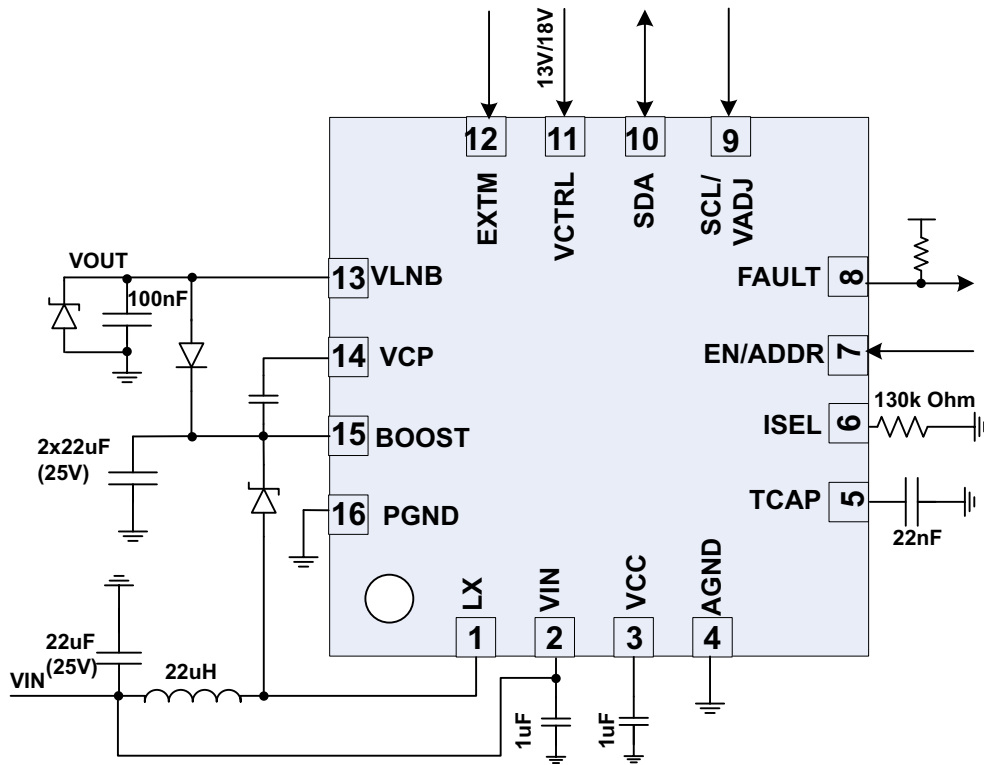

**PIN OUT**

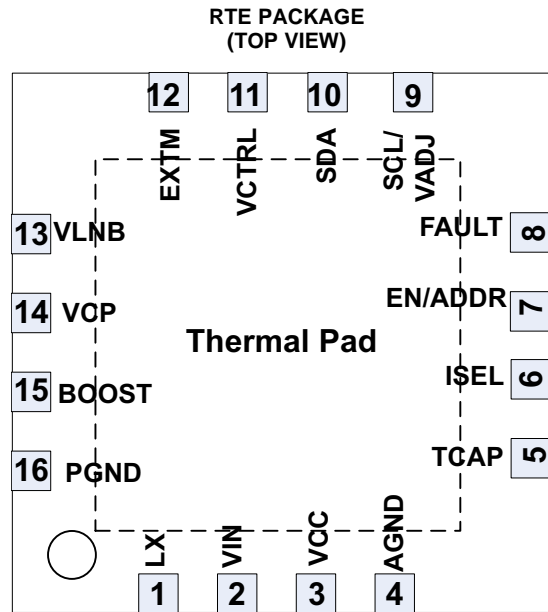

Exposed pad must be soldered to PCB for optimal thermal performance.

**TERMINAL FUNCTIONS**

NAME	NO.	DESCRIPTION
LX	1	Switching node of the boost converter
VIN	2	Input of internal linear regulator
VCC	3	Internal 6.5-V power supply bias. Connect a 1- $\mu$ F ceramic capacitor from this pin to ground. When $V_{IN}$ is 5 V, connect VCC to $V_{IN}$ .
AGND	4	Analog ground. Connect all ground pins and power pad together.
TCAP	5	Connect a capacitor to this pin to set the rise time and fall time of the LNB output between 13 V and 18 V.
ISEL	6	Connect a resistor to this pin to set the LNB output current limit.
EN/ADDR	7	Enable pin to enable the whole chip; pull to ground to disable output, output will be pulled to ground. For I <sup>2</sup> C interface, pulling this pin high or low gives different I <sup>2</sup> C addresses.
FAULT	8	This pin is an open drain output pin, it goes low if any fault flag is set.
SCL/VADJ	9	I <sup>2</sup> C compatible clock input; if I <sup>2</sup> C function is not used, connect this pin to low set output voltage 13 V/18 V, connect to high set output voltage 13.4 V/18.6 V.
SDA	10	I <sup>2</sup> C compatible bi-directional data
VCTRL	11	Logic control pin for 13-V or 18-V voltage selection at LNB output
EXTM	12	External modulation logic input pin which activates the 22-kHz tone output, feeding signal can be 22-kHz tone or logic high or low.
VLNB	13	Output of the LNB power supply connected to satellite receiver or switch
VCP	14	Gate drive supply voltage, output of charge pump, connect a capacitor between this pin to pin BOOST.
BOOST	15	Output of the boost regulator and input voltage of the internal linear regulator
PGND	16	Power ground for Boost Converter
Thermal PAD		Must be soldered to PCB for optimal thermal performance. Have thermal vias on the PCB to enhance power dissipation.

## ABSOLUTE MAXIMUM RATINGS <sup>(1)</sup>

over operating free-air temperature range (unless otherwise noted, all voltages are with respect to GND)

	Voltage range at VIN, LX, BOOST, VLNB	-1 to 30	V
	Voltage range at VCP	BOOST + 7V	V
	Voltage at LX	-1 to 30	V
	Voltage at VCC, EN, FAULT, SCL, SDA, VCTRL, ISEL, EXTM	-0.3 to 7	V
	Voltage at TCAP	-0.3 to 3.6	V
	Voltage at PGND, AGND	-0.3 to 0.3	V
T <sub>J</sub>	Operating junction temperature range	-40 to 125	°C
T <sub>STG</sub>	Storage temperature range	-55 to 150	°C

(1) Stresses beyond those listed under "absolute maximum ratings" may cause permanent damage to the device. These are stress ratings only, and functional operation of the device at these or any other conditions beyond those indicated under "recommended operating conditions" is not implied. Exposure to absolute-maximum-rated conditions for extended periods may affect device reliability.

## RECOMMENDED OPERATING CONDITIONS

over operating free-air temperature range (unless otherwise noted)

		MIN	NOM	MAX	UNIT
VIN	Input operating voltage	4.5		20	V
T <sub>A</sub>	Junction temperature	-40		85	°C

## THERMAL INFORMATION

THERMAL METRIC <sup>(1)</sup>		TPS65233	UNITS
		RTE	
		16 PINS	
θ <sub>JA</sub>	Junction-to-ambient thermal resistance <sup>(2)</sup>	43.4	°C/W
θ <sub>JCtop</sub>	Junction-to-case (top) thermal resistance <sup>(3)</sup>	45.6	
θ <sub>JB</sub>	Junction-to-board thermal resistance <sup>(4)</sup>	15	
ψ <sub>JT</sub>	Junction-to-top characterization parameter <sup>(5)</sup>	0.6	
ψ <sub>JB</sub>	Junction-to-board characterization parameter <sup>(6)</sup>	15	
θ <sub>JCbot</sub>	Junction-to-case (bottom) thermal resistance <sup>(7)</sup>	3.3	

- (1) For more information about traditional and new thermal metrics, see the *IC Package Thermal Metrics* application report, [SPRA953](#).
- (2) The junction-to-ambient thermal resistance under natural convection is obtained in a simulation on a JEDEC-standard, high-K board, as specified in JESD51-7, in an environment described in JESD51-2a.
- (3) The junction-to-case (top) thermal resistance is obtained by simulating a cold plate test on the package top. No specific JEDEC-standard test exists, but a close description can be found in the ANSI SEMI standard G30-88.
- (4) The junction-to-board thermal resistance is obtained by simulating in an environment with a ring cold plate fixture to control the PCB temperature, as described in JESD51-8.
- (5) The junction-to-top characterization parameter, ψ<sub>JT</sub>, estimates the junction temperature of a device in a real system and is extracted from the simulation data for obtaining θ<sub>JA</sub>, using a procedure described in JESD51-2a (sections 6 and 7).
- (6) The junction-to-board characterization parameter, ψ<sub>JB</sub>, estimates the junction temperature of a device in a real system and is extracted from the simulation data for obtaining θ<sub>JA</sub>, using a procedure described in JESD51-2a (sections 6 and 7).
- (7) The junction-to-case (bottom) thermal resistance is obtained by simulating a cold plate test on the exposed (power) pad. No specific JEDEC standard test exists, but a close description can be found in the ANSI SEMI standard G30-88.

## ELECTROSTATIC DISCHARGE (ESD) PROTECTION

	MIN	MAX	UNIT
Human body model (HBM), pin 13 (VLNB)	6000		V
Human body model (HBM), other pins	2000		V
Charge device model (CDM)	500		V

**ELECTRICAL CHARACTERISTICS**
 $T_J = -40^{\circ}\text{C}$  to  $125^{\circ}\text{C}$ ,  $V_{IN} = 12\text{ V}$ ,  $f_{SW} = 528\text{ kHz}$  (unless otherwise noted)

PARAMETER		TEST CONDITIONS	MIN	TYP	MAX	UNIT
<b>INPUT SUPPLY</b>						
$V_{IN}$	Input voltage range	$V_{IN}$	4.5	12	20	V
$I_{DDSDN}$	Shutdown supply current	$EN = 0$		160		$\mu\text{A}$
$I_{DDQ}$	Quiescent power supply current	$EN = 1, I_{OUT} = 0\text{ A}, V_{LNB} = 18\text{ V}$		23		$\text{mA}$
$UVLO$	$V_{IN}$ under voltage lockout	Rising $V_{IN}$	4.05	4.25	4.45	V
		Falling $V_{IN}$	3.6	3.8	4.1	
		Hysteresis		450		$\text{mV}$
<b>OUTPUT VOLTAGE</b>						
$V_{OUT}$	Regulated output voltage	$V_{ctrl} = 1, I_{OUT} = 500\text{ mA}$	18.2	18.6	19	V
		$V_{ctrl} = 0, I_{OUT} = 500\text{ mA}$	13.1	13.4	13.7	
$V_{LINEREG}$	Line regulation-DC	$V_{IN} = 7.5\text{ V to }16\text{ V}, I_{OUT} = 500\text{ mA}$		0.2		$\%/V$
$V_{LOADREG}$	Load regulation-DC	$I_{OUT} = (10\text{-}90\%)*I_{OUTMAX}$		0.7		$\%/A$
$IOCP$	Output short circuit current limit	$R_{SEL} = 200\text{ k}\Omega, T_J = 25^{\circ}\text{C}$	580	650	720	$\text{mA}$
$T_r, T_f$	13 V/18 V Transition rising falling time	$C_{cap} = 5.6\text{ nF}$		0.33		$\text{ms}$
$f_{SW}$	Boost switching frequency		490	528	570	$\text{kHz}$
$I_{limitsw}$	Switching current limit	$V_{IN} = 12\text{ V}, V_{OUT} = 18.6\text{ V}$		3.2		A
$R_{dson\_LS}$	On resistance of low side FET on CH	$V_{IN} = 12\text{ V}$		120		$\text{m}\Omega$
$V_{drop}$	Linear regulator voltage drop-out	$I_{OUT} = 500\text{ mA}$		0.8		V
$I_{rev}$	Reverse bias current	$EN = 1, V_{LNB} = 21\text{ V}$		50		$\text{mA}$
$I_{rev\_dis}$	Disabled reverse bias current	$EN = 0, V_{LNB} = 21\text{ V}$		3		$\text{mA}$
<b>LOGIC SIGNALS</b>						
$V_{EN}$	Enable threshold level			1.15		V
$V_{ENH}$	Enable threshold level hysteresis			80		$\text{mV}$
$V_{LOGICH}, V_{LOGICL}$	$V_{CTRL}, \text{EXTM}$ Logic threshold level	High level input voltage	2			V
		Low level input voltage			0.8	
$V_{OL\_FAULT}$	FAULT Output low voltage	FAULT open drain, $I_{OL} = 1\text{ mA}$			0.4	V
$f_{I2C}$	Maximum I <sup>2</sup> C clock frequency		400			$\text{kHz}$
<b>TONE</b>						
$f_{tone}$	Tone frequency		20	22	24	$\text{kHz}$
$A_{tone}$	Tone amplitude	$I_{OUT} = 0\text{ mA to }500\text{ mA}, C_{OUT} = 100\text{ nF}$	550	680	750	$\text{mV}$
$D_{tone}$	Tone duty cycle		45	50	55	%
$T_{rtone}$	Tone rise time	$I_{OUT} = 0\text{ mA to }500\text{ mA}, C_{OUT} = 100\text{ nF}$		10		$\mu\text{S}$
$T_{ftone}$	Tone fall time	$I_{OUT} = 0\text{ mA to }500\text{ mA}, C_{OUT} = 100\text{ nF}$		10		$\mu\text{S}$
<b>PROTECTION</b>						
$TON$	Over Current Protection On Time			4		$\text{ms}$
$TOFF$	Over Current Protection Off Time			128		$\text{ms}$

**ELECTRICAL CHARACTERISTICS (continued)**
 $T_J = -40^{\circ}\text{C}$  to  $125^{\circ}\text{C}$ ,  $V_{IN} = 12\text{ V}$ ,  $f_{SW} = 528\text{ kHz}$  (unless otherwise noted)

PARAMETER	TEST CONDITIONS	MIN	TYP	MAX	UNIT
<b>THERMAL SHUTDOWN</b>					
$T_{TRIP}$	Thermal shut down trip point		160		$^{\circ}\text{C}$
$T_{HYST}$	Thermal shut down hysteresis		20		$^{\circ}\text{C}$
<b>I<sup>2</sup>C READ BACK FAULT STATUS</b>					
$V_{PGOOD}$	PGOOD Trip levels	Feedback voltage low side rising	95.3		%
		Feedback voltage low side falling	94.7		
		Feedback voltage high side rising	105.3		
		Feedback voltage high side falling	104.7		
$T_{warn}$	Temperature warning threshold		125		$^{\circ}\text{C}$
<b>I<sup>2</sup>C INTERFACE</b>					
$V_{IH}$	SDA,SCL Input high voltage		2		V
$V_{IL}$	SDA,SCL Input low voltage			0.8	V
$I_I$	Input current	SDA, SCL, $V_I = 0.4\text{ V}$ to $4.5\text{ V}$	-10	10	$\mu\text{A}$
$V_{OL}$	SDA Output low voltage	SDA open drain, $I_{OL} = 2\text{ mA}$		0.4	V
$f_{(SCL)}$	Maximum SCL clock frequency		400		kHz
$t_{BUF}$	Bus free time between a STOP and START condition		1.3		$\mu\text{s}$
$t_{HD\_STA}$	Hold time (Repeated) START condition		0.6		$\mu\text{s}$
$t_{SU\_STO}$	Setup time for STOP condition		0.6		$\mu\text{s}$
$t_{LOW}$	LOW Period of the SCL clock		1.3		$\mu\text{s}$
$t_{HIGH}$	HIGH Period of the SCL clock		0.6		$\mu\text{s}$
$t_{SU\_STA}$	Setup time for a repeated START condition		0.6		$\mu\text{s}$
$t_{SU\_DAT}$	Data setup time		0.1		$\mu\text{s}$
$t_{HD\_DAT}$	Data hold time		0	0.9	$\mu\text{s}$
$t_{RCL}$	Rise time of SCL signal	Capacitance of one bus line (pF)	$20 + 0.1C_B$	300	ns
$t_{RCL1}$	Rise time of SCL signal after a repeated START condition and after an acknowledge BIT	Capacitance of one bus line (pF)	$20 + 0.1C_B$	300	ns
$t_{FCL}$	Fall time of SCL signal	Capacitance of one bus line (pF)	$20 + 0.1C_B$	300	ns
$t_{RDA}$	Rise time of SDA signal	Capacitance of one bus line (pF)	$20 + 0.1C_B$	300	ns
$t_{FDA}$	Fall time of SDA signal	Capacitance of one bus line (pF)	$20 + 0.1C_B$	300	ns
$C_B$	Capacitance of one bus line (SCL and SDA)			400	pF

### TYPICAL CHARACTERISTICS

$T_A = 25^\circ\text{C}$ ,  $V_{IN} = 12\text{ V}$ ,  $f_{SW} = 528\text{ kHz}$ ,  $C_{boost} = 2 \times 22\ \mu\text{F}$  (unless otherwise noted)

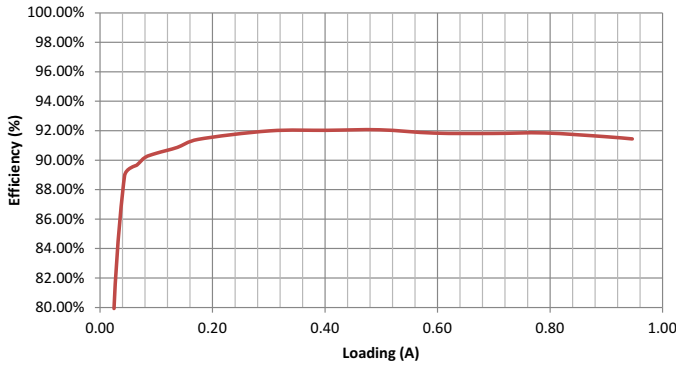

Figure 1. Efficiency ( $V_{IN} = 12\text{ V}$ ,  $V_{LNB} = 13.4\text{ V}$ )

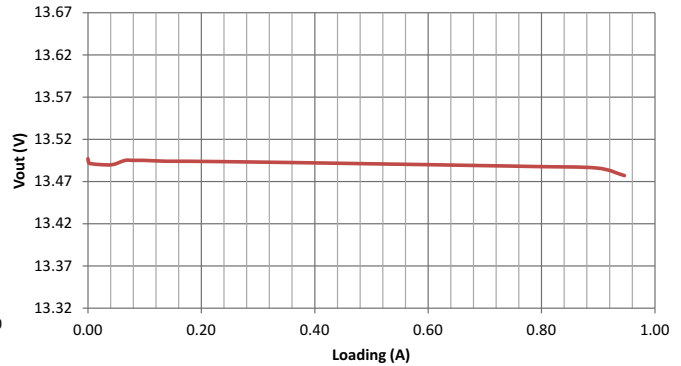

Figure 2. Load Regulation ( $V_{IN} = 12\text{ V}$ ,  $V_{LNB} = 13.4\text{ V}$ )

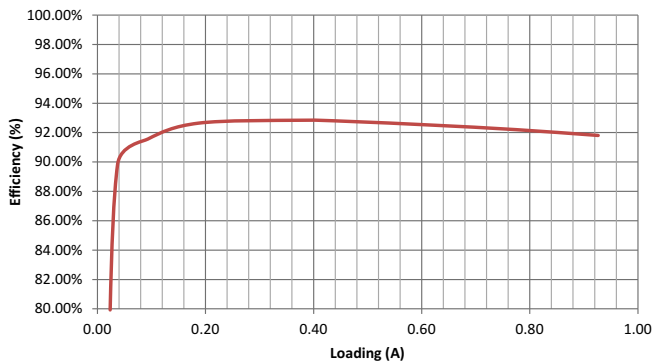

Figure 3. Efficiency ( $V_{IN} = 12\text{ V}$ ,  $V_{LNB} = 18.6\text{ V}$ )

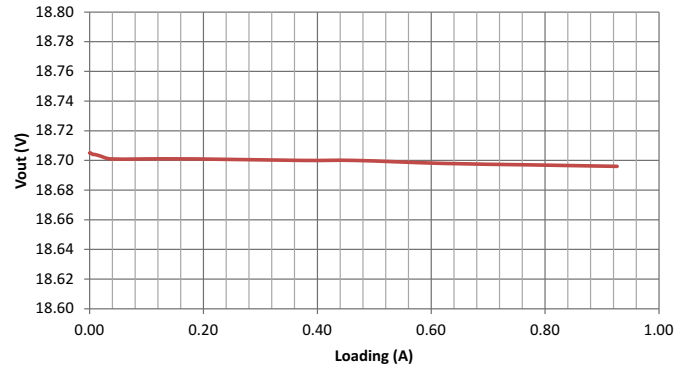

Figure 4. Load Regulation ( $V_{IN} = 12\text{ V}$ ,  $V_{LNB} = 18.6\text{ V}$ )

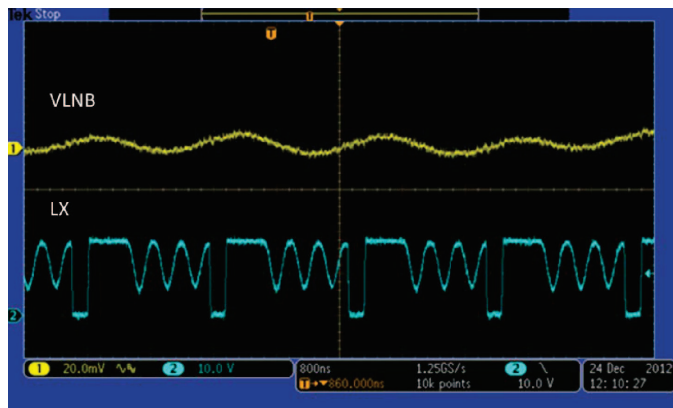

Figure 5. Boost LX Waveform at 0 A, ( $V_{IN} = 12\text{ V}$ ,  $V_{LNB} = 13.4\text{ V}$ )

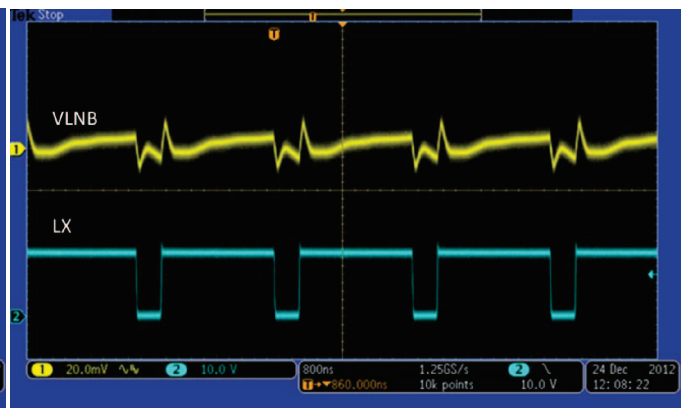

Figure 6. Boost LX Waveform at 0.5 A, ( $V_{IN} = 12\text{ V}$ ,  $V_{LNB} = 13.4\text{ V}$ )



**TYPICAL CHARACTERISTICS (continued)**

$T_A = 25^\circ\text{C}$ ,  $V_{IN} = 12\text{ V}$ ,  $f_{SW} = 528\text{ kHz}$ ,  $C_{boost} = 2 \times 22\ \mu\text{F}$  (unless otherwise noted)

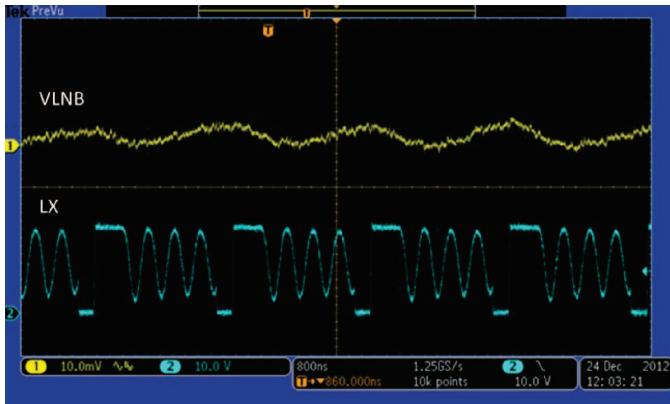

Figure 7. Boost LX Waveform at 0 A, ( $V_{IN} = 12\text{ V}$ ,  $V_{LNB} = 18.6\text{ V}$ )

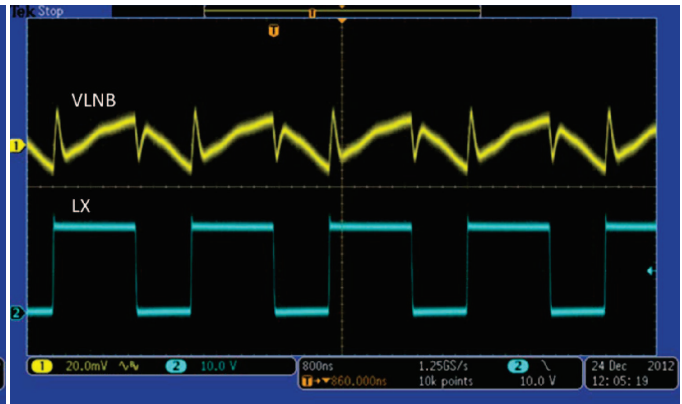

Figure 8. Boost LX Waveform at 0.5 A, ( $V_{IN} = 12\text{ V}$ ,  $V_{LNB} = 18.6\text{ V}$ )

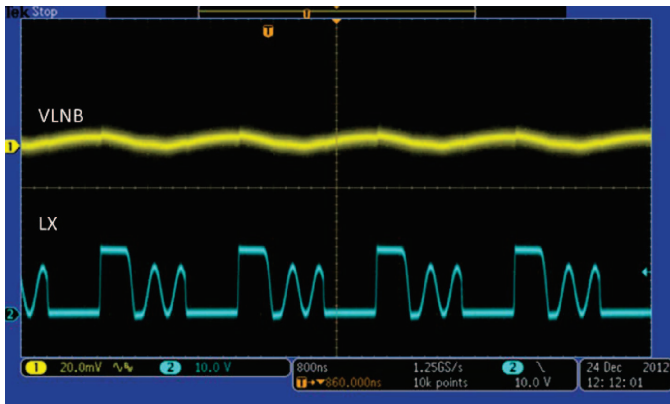

Figure 9. Boost LX Waveform at 0 A, ( $V_{IN} = 5\text{ V}$ ,  $V_{LNB} = 13.4\text{ V}$ )

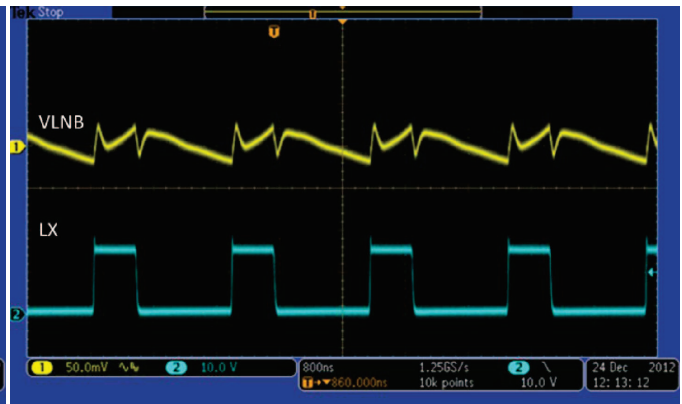

Figure 10. Boost LX Waveform at 0.5 A, ( $V_{IN} = 5\text{ V}$ ,  $V_{LNB} = 13.4\text{ V}$ )

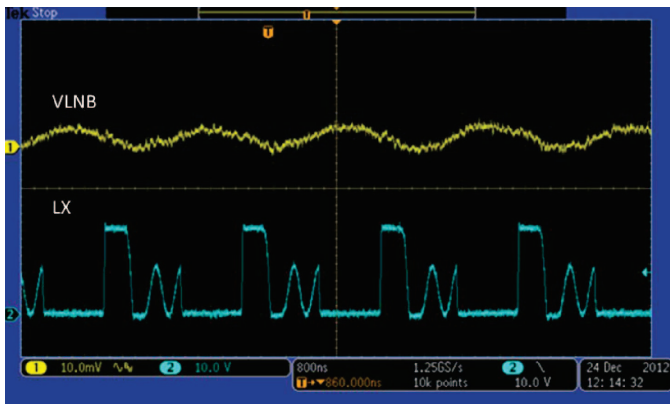

Figure 11. Boost LX Waveform at 0 A, ( $V_{IN} = 5\text{ V}$ ,  $V_{LNB} = 18.6\text{ V}$ )

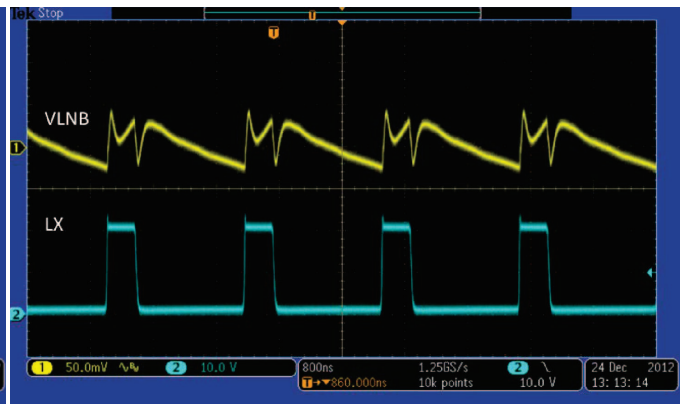

Figure 12. Boost LX Waveform at 0.5 A, ( $V_{IN} = 5\text{ V}$ ,  $V_{LNB} = 18.6\text{ V}$ )

**TYPICAL CHARACTERISTICS (continued)**

$T_A = 25^\circ\text{C}$ ,  $V_{IN} = 12\text{ V}$ ,  $f_{SW} = 528\text{ kHz}$ ,  $C_{boost} = 2 \times 22\ \mu\text{F}$  (unless otherwise noted)

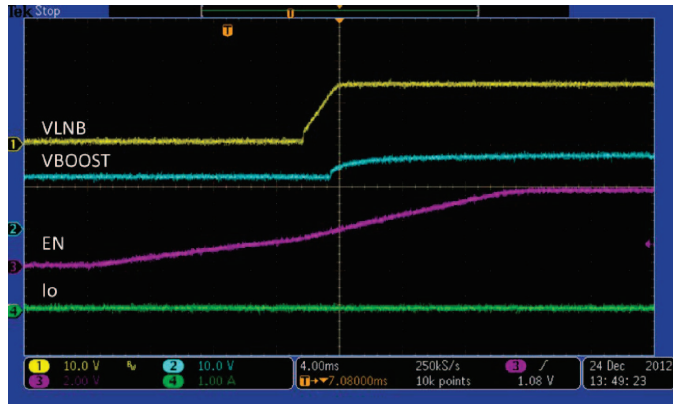

Figure 13.  $V_{IN} = 12\text{ V}$ ,  $V_{LNB} = 13.4\text{ V}$ , No Loading, Soft Start

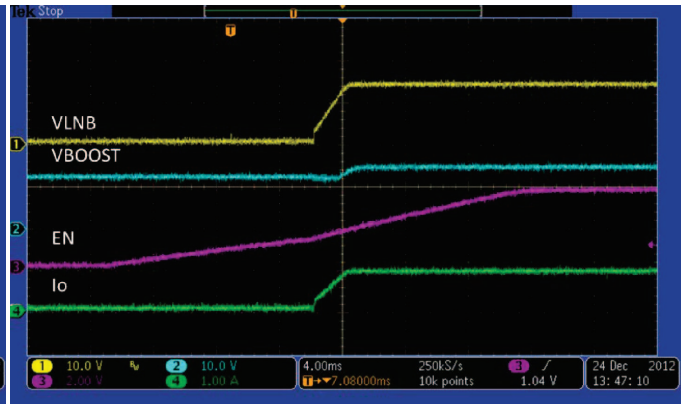

Figure 14.  $V_{IN} = 12\text{ V}$ ,  $V_{LNB} = 13.4\text{ V}$ , 1 A, Soft Start

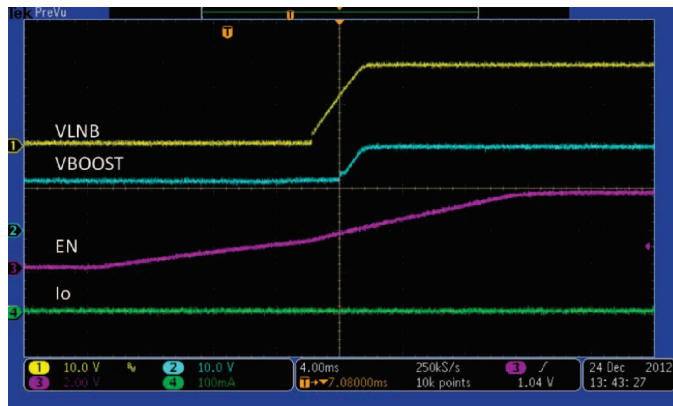

Figure 15.  $V_{IN} = 12\text{ V}$ ,  $V_{LNB} = 18.6\text{ V}$ , No Loading, Soft Start

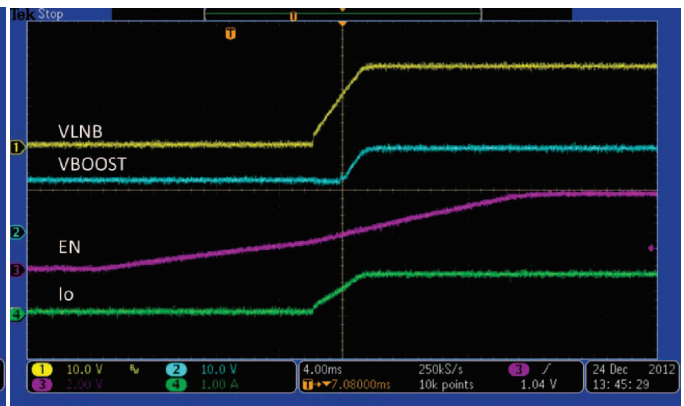

Figure 16.  $V_{IN} = 12\text{ V}$ ,  $V_{LNB} = 18.6\text{ V}$ , 1 A, Soft Start

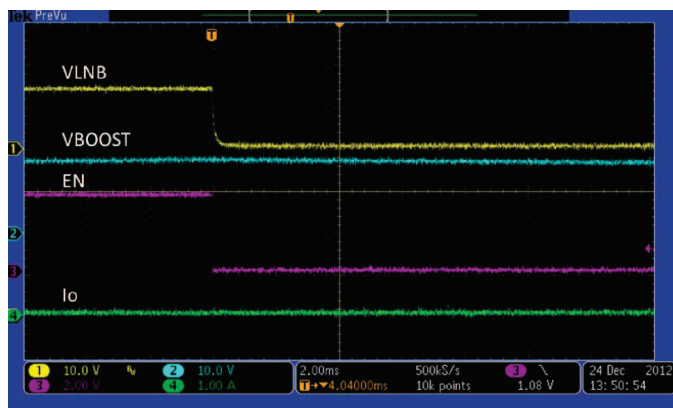

Figure 17.  $V_{IN} = 12\text{ V}$ ,  $V_{LNB} = 13.4\text{ V}$ , 0 A, Shutdown

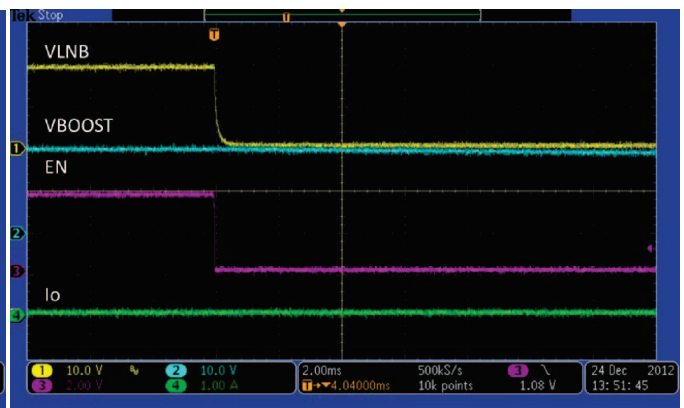

Figure 18.  $V_{IN} = 12\text{ V}$ ,  $V_{LNB} = 18.6\text{ V}$ , 0 A, Shutdown

**TYPICAL CHARACTERISTICS (continued)**

$T_A = 25^\circ\text{C}$ ,  $V_{IN} = 12\text{ V}$ ,  $f_{SW} = 528\text{ kHz}$ ,  $C_{boost} = 2 \times 22\ \mu\text{F}$  (unless otherwise noted)

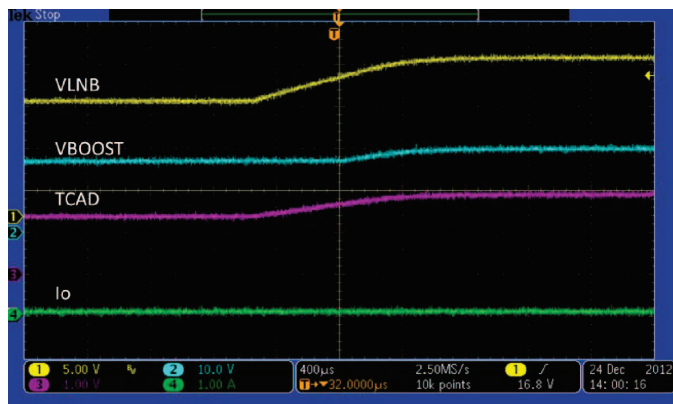

Figure 19.  $V_{IN} = 12\text{ V}$ ,  $V_{LNB} = 13.4\text{ V to } 18.6\text{ V}$ , 0 A, Voltage Transition

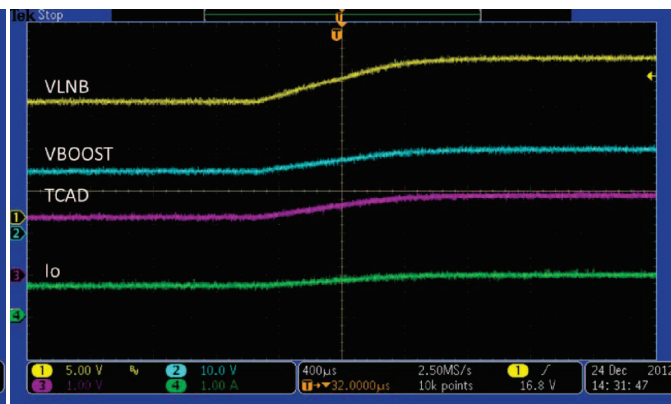

Figure 20.  $V_{IN} = 12\text{ V}$ ,  $V_{LNB} = 13.4\text{ V to } 18.6\text{ V}$ , 1 A, Voltage Transition

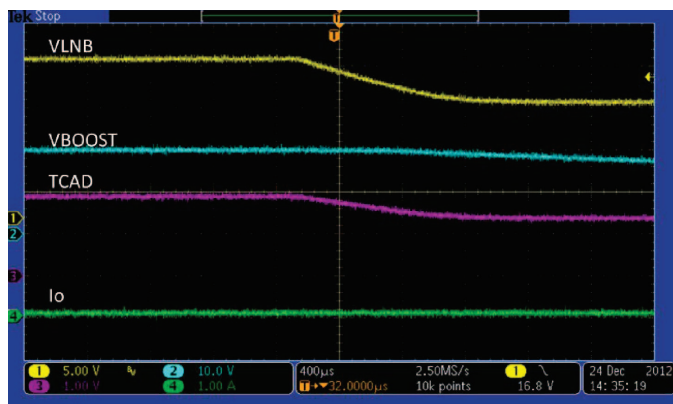

Figure 21.  $V_{IN} = 12\text{ V}$ ,  $V_{LNB} = 18.6\text{ V to } 13.4\text{ V}$ , 0 A, Voltage Transition

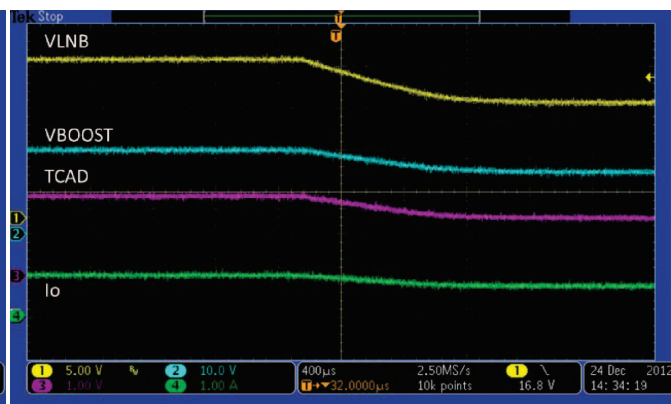

Figure 22.  $V_{IN} = 12\text{ V}$ ,  $V_{LNB} = 18.6\text{ V to } 13.4\text{ V}$ , 1 A, Voltage Transition

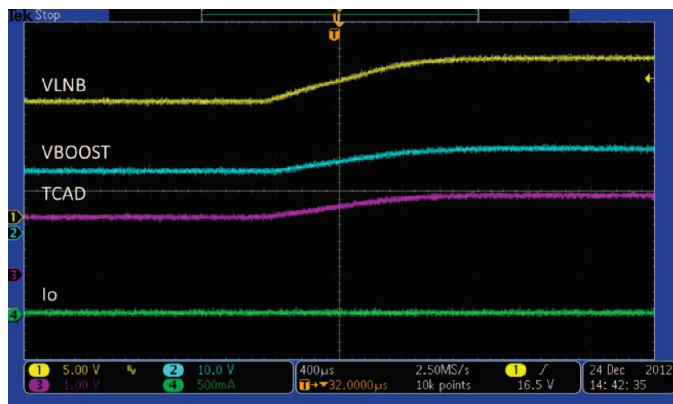

Figure 23.  $V_{IN} = 5\text{ V}$ ,  $V_{LNB} = 13.4\text{ V to } 18.6\text{ V}$ , 0 A, Voltage Transition

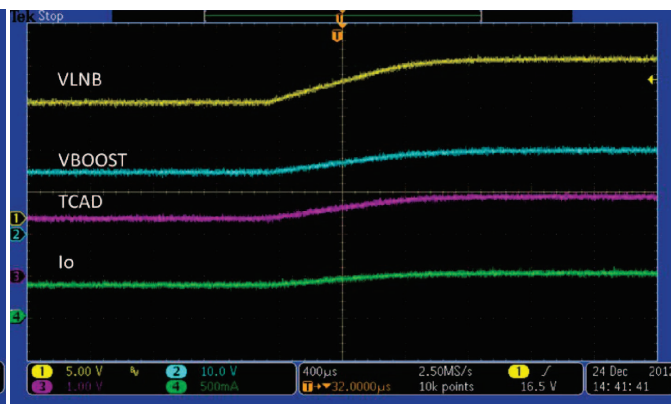

Figure 24.  $V_{IN} = 5\text{ V}$ ,  $V_{LNB} = 13.4\text{ V to } 18.6\text{ V}$ , 0.5 A, Voltage Transition

**TYPICAL CHARACTERISTICS (continued)**

$T_A = 25^\circ\text{C}$ ,  $V_{IN} = 12\text{ V}$ ,  $f_{SW} = 528\text{ kHz}$ ,  $C_{boost} = 2 \times 22\ \mu\text{F}$  (unless otherwise noted)

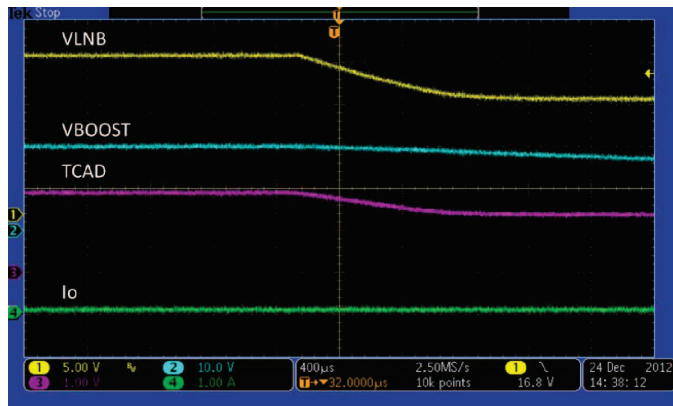

Figure 25.  $V_{IN} = 5\text{ V}$ ,  $V_{LNB} = 18.6\text{ V}$  to  $13.4\text{ V}$ ,  $0\text{ A}$ , Voltage Transition

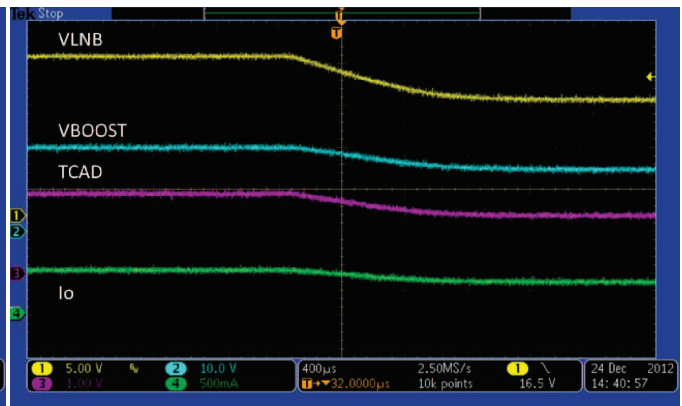

Figure 26.  $V_{IN} = 5\text{ V}$ ,  $V_{LNB} = 18.6\text{ V}$  to  $13.4\text{ V}$ ,  $0.5\text{ A}$ , Voltage Transition

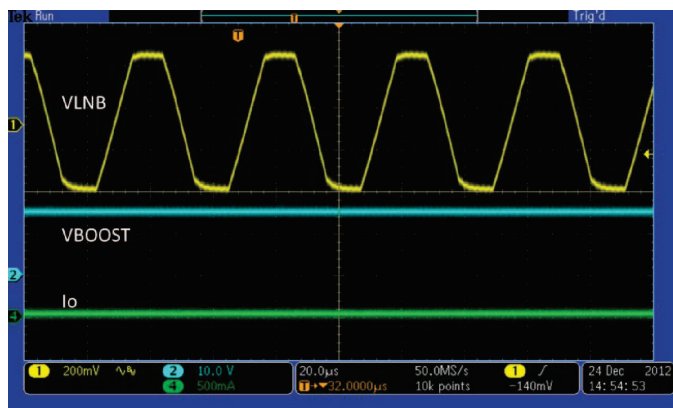

Figure 27.  $V_{IN} = 12\text{ V}$ ,  $V_{LNB} = 13.4\text{ V}$ , No Loading, 22-kHz Tone

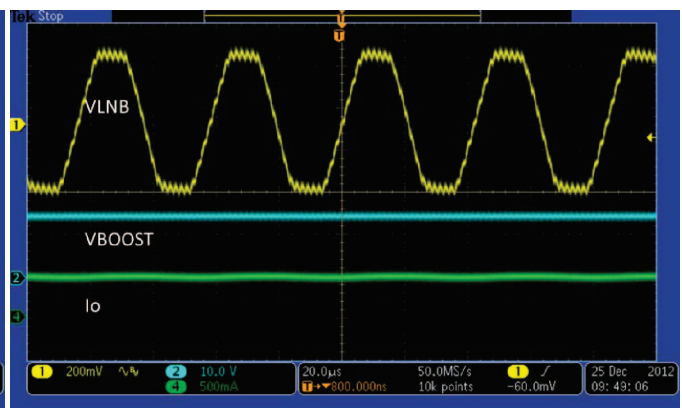

Figure 28.  $V_{IN} = 12\text{ V}$ ,  $V_{LNB} = 13.4\text{ V}$ ,  $1\text{ A}$ , 22-kHz Tone

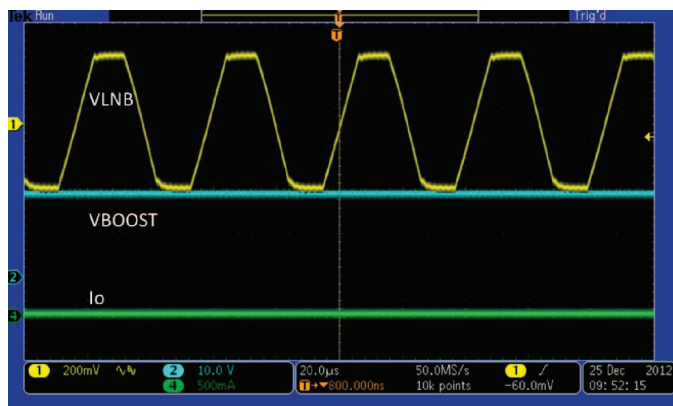

Figure 29.  $V_{IN} = 12\text{ V}$ ,  $V_{LNB} = 18.6\text{ V}$ , No Loading, 22-kHz Tone

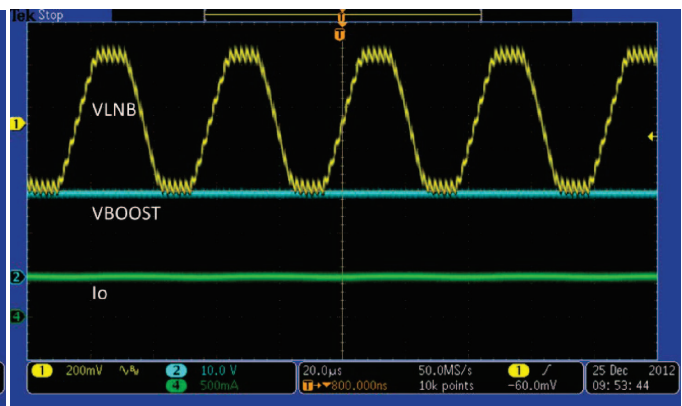

Figure 30.  $V_{IN} = 12\text{ V}$ ,  $V_{LNB} = 18.6\text{ V}$ ,  $1\text{ A}$ , 22-kHz Tone

**TYPICAL CHARACTERISTICS (continued)**

$T_A = 25^\circ\text{C}$ ,  $V_{IN} = 12\text{ V}$ ,  $f_{SW} = 528\text{ kHz}$ ,  $C_{boost} = 2 \times 22\ \mu\text{F}$  (unless otherwise noted)

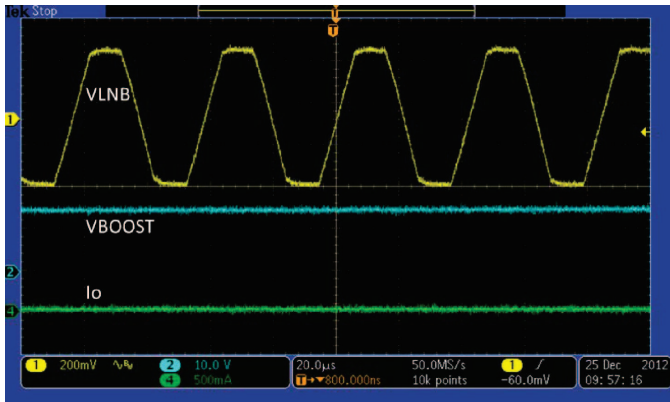

Figure 31.  $V_{IN} = 5\text{ V}$ ,  $V_{LNB} = 13.4\text{ V}$ , No Loading, 22-kHz Tone

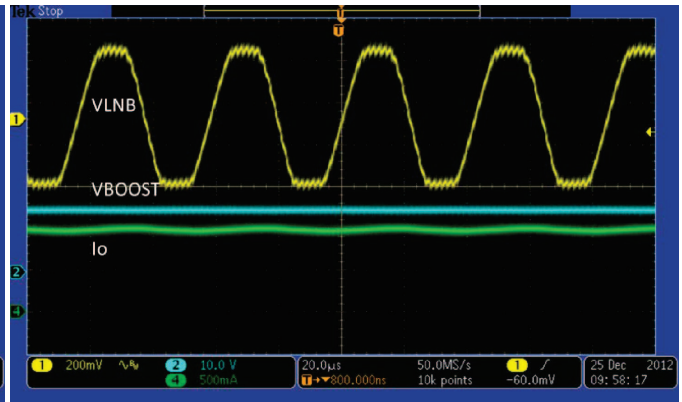

Figure 32.  $V_{IN} = 5\text{ V}$ ,  $V_{LNB} = 13.4\text{ V}$ , 0.5 A, 22-kHz Tone

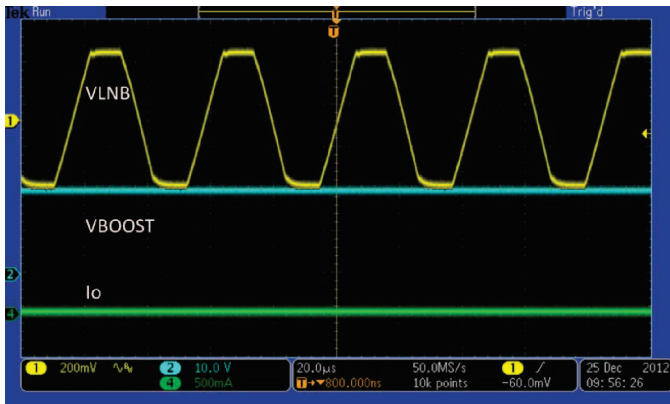

Figure 33.  $V_{IN} = 5\text{ V}$ ,  $V_{LNB} = 18.6\text{ V}$ , No Loading, 22-kHz Tone

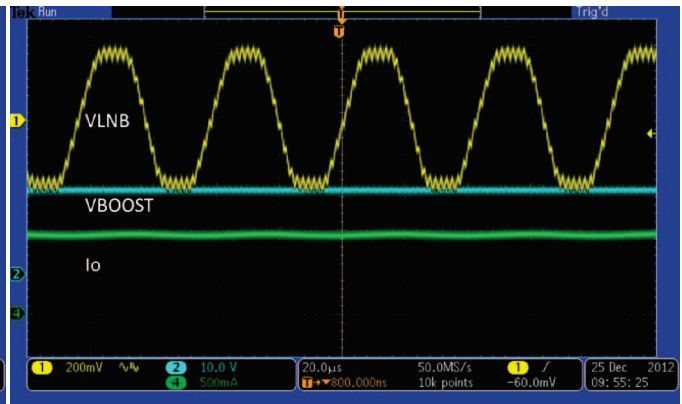

Figure 34.  $V_{IN} = 5\text{ V}$ ,  $V_{LNB} = 18.6\text{ V}$ , 0.5 A, 22-kHz Tone

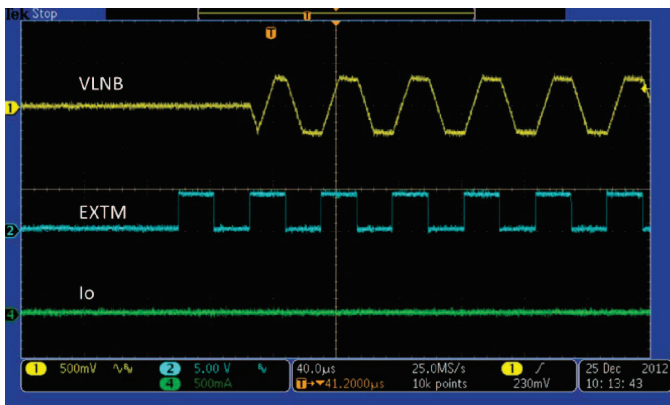

Figure 35.  $V_{IN} = 12\text{ V}$ ,  $V_{LNB} = 13.4\text{ V}$ , No Loading, 22-kHz Tone Delay from EXTM Turns High to Output Tone, On

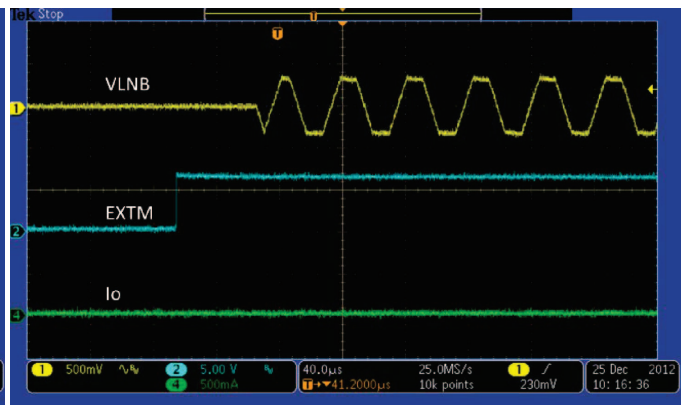
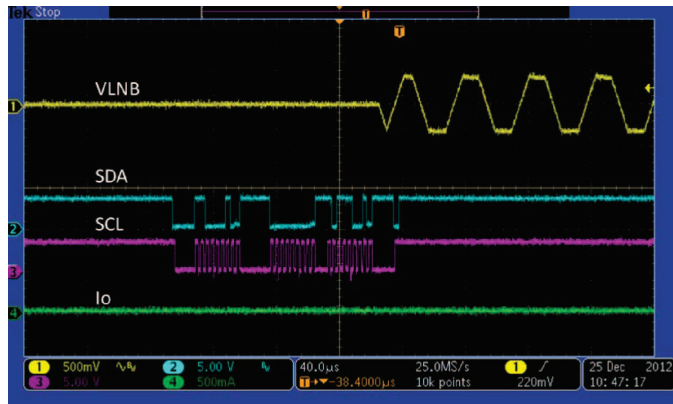

Figure 36.  $V_{IN} = 12\text{ V}$ ,  $V_{LNB} = 13.4\text{ V}$ , No Loading, 22-kHz Tone Delay from EXTM Turns High to Output Tone, On

**TYPICAL CHARACTERISTICS (continued)**

$T_A = 25^\circ\text{C}$ ,  $V_{IN} = 12\text{ V}$ ,  $f_{SW} = 528\text{ kHz}$ ,  $C_{boost} = 2 \times 22\ \mu\text{F}$  (unless otherwise noted)



**Figure 37.**  $V_{IN} = 12\text{ V}$ ,  $V_{LNB} = 13.4\text{ V}$ , No Loading, 22-kHz Tone Delay from I<sup>2</sup>C SDA to Output Tone, On

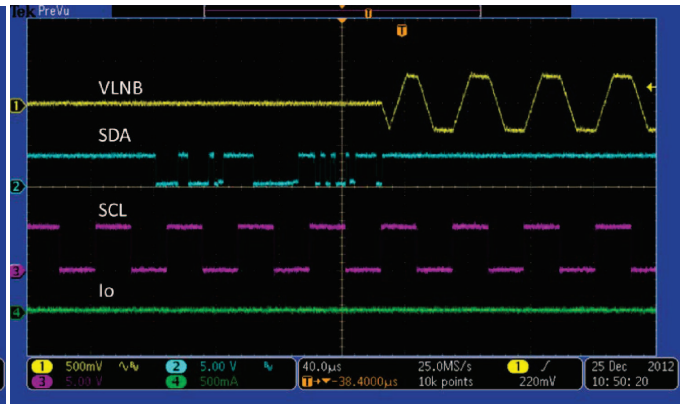

**Figure 38.**  $V_{IN} = 12\text{ V}$ ,  $V_{LNB} = 13.4\text{ V}$ , No Loading, 22-kHz Tone Delay from I<sup>2</sup>C Gated, EXT<sub>M</sub> Provides 22 kHz to Output Tone, On

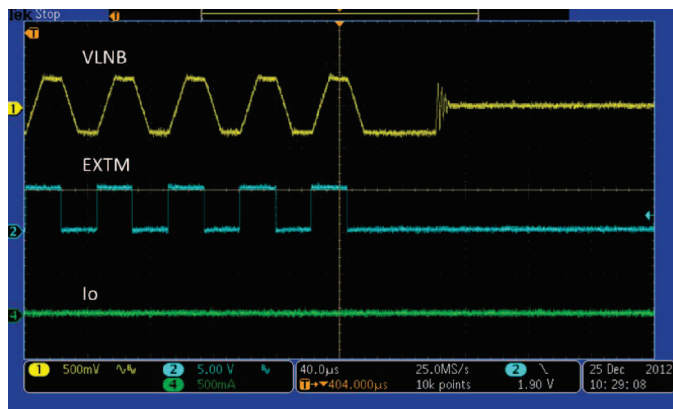

**Figure 39.**  $V_{IN} = 12\text{ V}$ ,  $V_{LNB} = 13.4\text{ V}$ , No Loading, 22-kHz Tone Delay from EXT<sub>M</sub> 22 kHz to Output Tone, Off

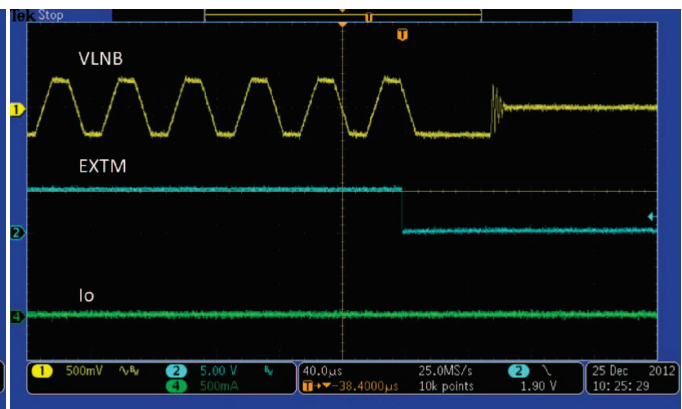

**Figure 40.**  $V_{IN} = 12\text{ V}$ ,  $V_{LNB} = 13.4\text{ V}$ , No Loading, 22-kHz Tone Delay from EXT<sub>M</sub> Turns High to output Tone, Off

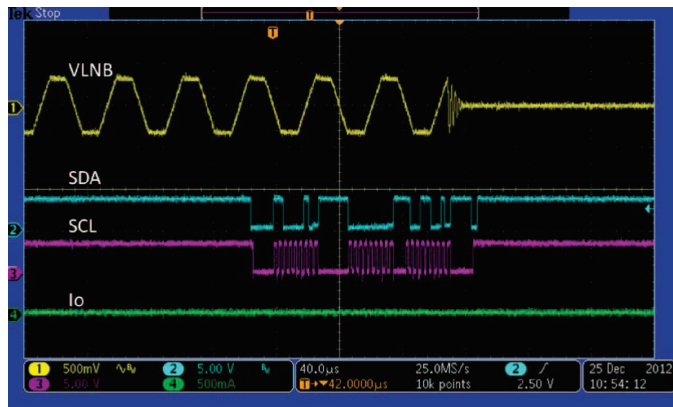

**Figure 41.**  $V_{IN} = 12\text{ V}$ ,  $V_{LNB} = 13.4\text{ V}$ , No Loading, 22-kHz Tone Delay from I<sup>2</sup>C SDA to Output Tone, Off

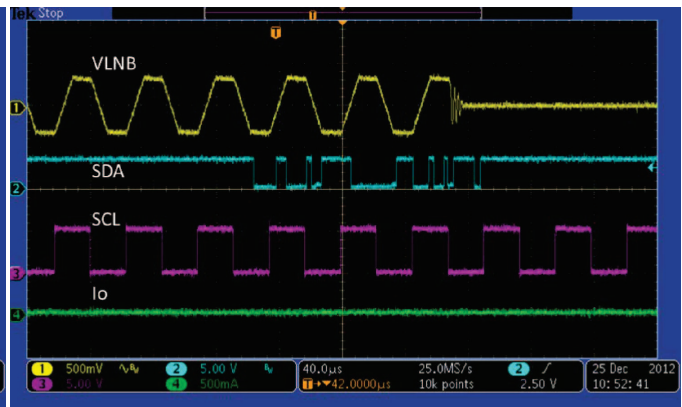

**Figure 42.**  $V_{IN} = 12\text{ V}$ ,  $V_{LNB} = 13.4\text{ V}$ , No Loading, 22-kHz Tone Delay from I<sup>2</sup>C Gated, EXT<sub>M</sub> Provides 22 kHz to Output Tone, Off

**TYPICAL CHARACTERISTICS (continued)**

$T_A = 25^\circ\text{C}$ ,  $V_{IN} = 12\text{ V}$ ,  $f_{SW} = 528\text{ kHz}$ ,  $C_{boost} = 2 \times 22\ \mu\text{F}$  (unless otherwise noted)

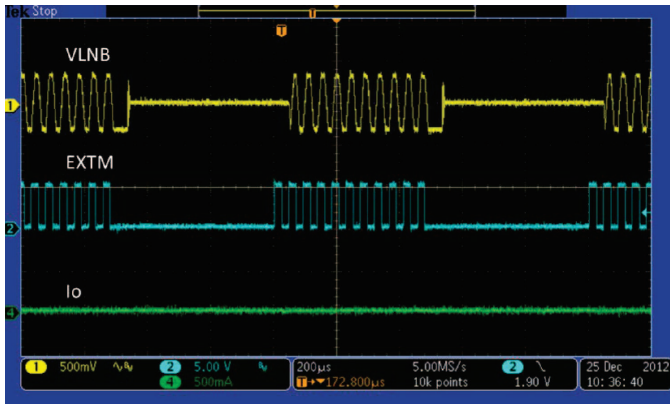

Figure 43.  $V_{IN} = 12\text{ V}$ ,  $V_{LNB} = 13.4\text{ V}$ , No Loading, Tone Burst

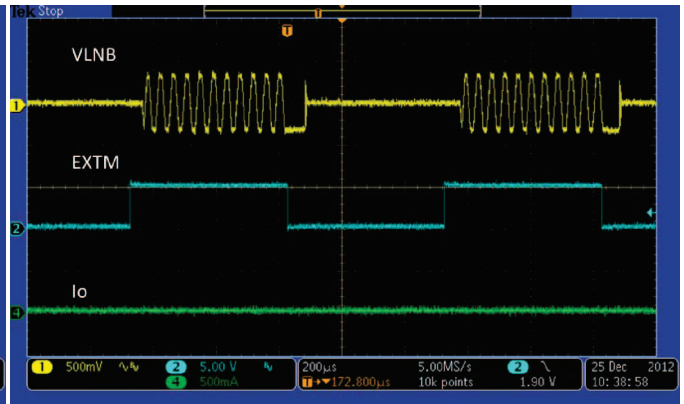

Figure 44.  $V_{IN} = 12\text{ V}$ ,  $V_{LNB} = 13.4\text{ V}$ , No Loading, EXT\_M Level

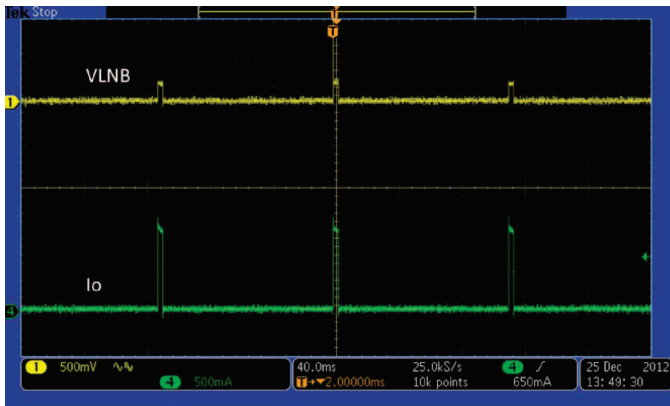

Figure 45.  $V_{IN} = 12\text{ V}$ ,  $V_{LNB} = 13.4\text{ V}$ , Hard Short

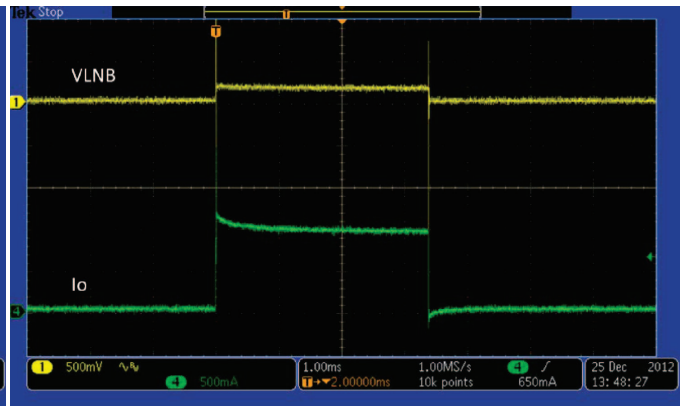

Figure 46.  $V_{IN} = 12\text{ V}$ ,  $V_{LNB} = 13.4\text{ V}$ , Hard Short

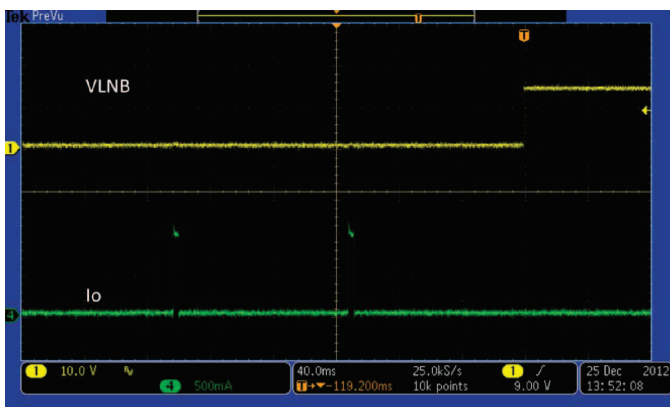

Figure 47.  $V_{IN} = 12\text{ V}$ ,  $V_{LNB} = 13.4\text{ V}$ , Hard Short Recovery

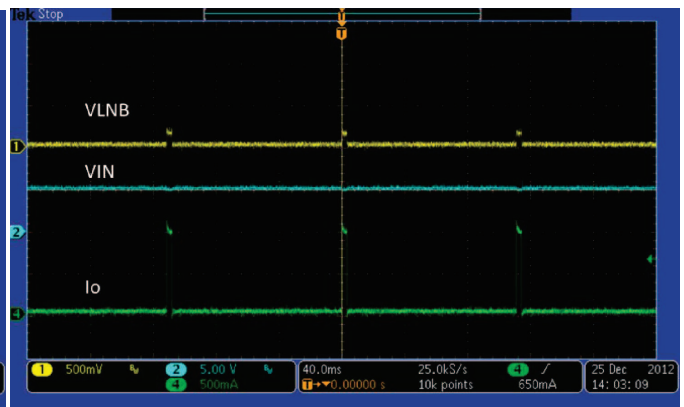

Figure 48.  $V_{IN} = 5\text{ V}$ ,  $V_{LNB} = 13.4\text{ V}$ , Hard Short

**TYPICAL CHARACTERISTICS (continued)**

$T_A = 25^\circ\text{C}$ ,  $V_{IN} = 12\text{ V}$ ,  $f_{SW} = 528\text{ kHz}$ ,  $C_{boost} = 2 \times 22\ \mu\text{F}$  (unless otherwise noted)

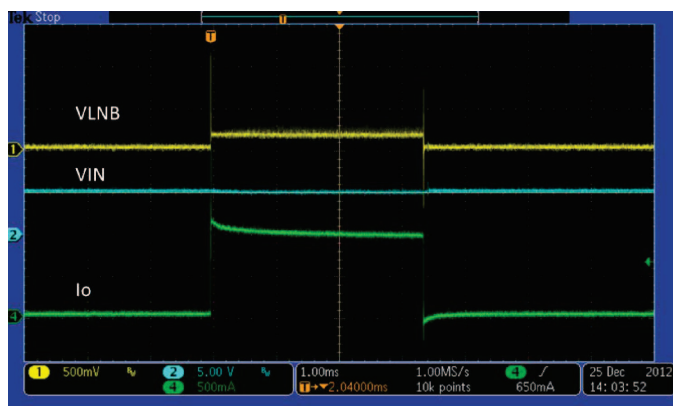

Figure 49.  $V_{IN} = 5\text{ V}$ ,  $V_{LNB} = 13.4\text{ V}$ , Hard Short

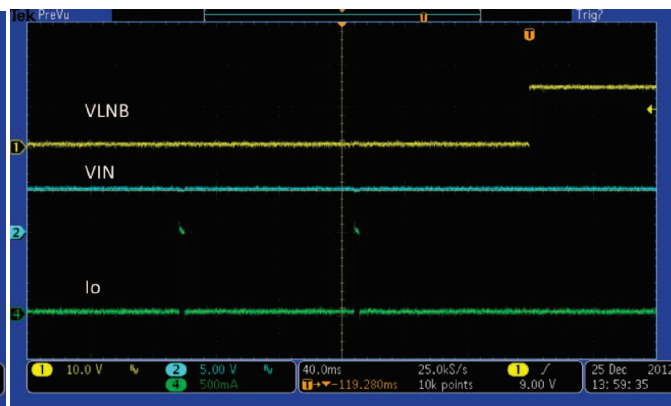

Figure 50.  $V_{IN} = 5\text{ V}$ ,  $V_{LNB} = 13.4\text{ V}$ , Hard Short Recovery



## OVERVIEW

TPS65233 is a power management IC that integrates a boost converter, a LDO and a 22-kHz tone generator serves as a LNB power supply. This solution compiles the DiSEqC 1.x standard with or without I<sup>2</sup>C interface. Output current can be precisely programmed by an external resistor. There are four ways to generate the 22-kHz tone signal with or without I<sup>2</sup>C. Integrated boost features low R<sub>dson</sub> MOSFET and internal compensation. Fixed 500-kHz switching frequency is designed to reduce components size.

## DETAILED DESCRIPTION

### Boost Converter

The TPS65233 consists of an internal compensated boost converter and linear regulator. The boost converter tracks the output LNB voltage to within 800 mV even at loading 750 mA, to minimize power dissipation. Under conditions where the input voltage, VBOOST, is greater than the output voltage, VLNB, the linear regulator must drop the differential voltage. When operating in these conditions, care must be taken to ensure that the safe operating temperature range of the TPS65233 is not exceeded. The boost converter operates at 528 kHz typical. The TPS65233 has internal pulse-by-pulse current limiting on the boost converter and DC current limiting on the LNB output to protect the IC against short circuits. When the LNB output is shorted, the LNB output current is limited. The current limit is set by the external resistor. And the IC will be shut down if the overcurrent condition lasts for more than 4 ms, the converter enters hiccup mode and will re-try startup in 128 ms. At extremely light loads, the boost converter operates in a pulse-skipping mode.

If two or more set top box LNB outputs are connected together, one output voltage could be set higher than others. The output with lower set voltage would be effectively turned off. Once the voltage drops to the set level, the LNB output with lower set output voltage will return to normal conditions.

### Linear Regulator and Current Limit

The linear regulator is used to generate the 22-kHz tone signal by changing the reference voltage. The linear regulator features low drop out voltage to minimize power loss while keeps enough head room for the 0.68-V, 22-kHz tone. It also implements a tight current limit for over current protection. The current limit is set by an external resistor connected to ISEL pin. The curve below shows the relationship between the current limit threshold and the resistor value.

### RISEL versus ISEL

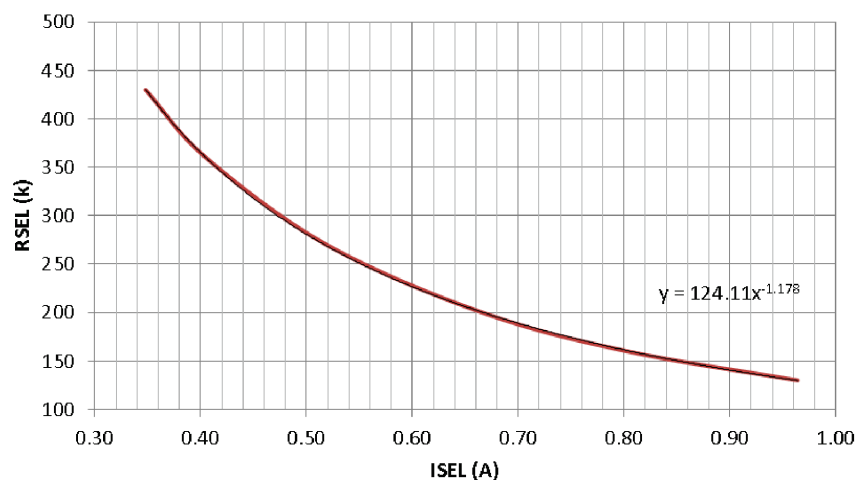

Figure 51. Linear Regulator Current Limit Versus Resistor

$$R_{SEL}(\text{k}\Omega) = 124.11 \cdot I_{SEL}^{-1.178}(\text{A}) \quad (1)$$

A 270-k $\Omega$  resistor set the current to be 0.5 A.

The current limit can also be set by I<sup>2</sup>C through register.

## Charge Pump

The charge pump circuitry generates a voltage to drive the NMOS of the linear regulator. One end the charge pump capacitor is connected to the output of the boost converter. The voltage on the charge pump capacitor is about 6.25 V.

## Slew Rate Control

When LNB output voltage transits from 13 V to 18 V or vice versa, the capacitor at pin TCAP controls the transition time. This transition is to make sure the boost converter can follow the voltage change. Usually boost converter has low bandwidth and can't response fast. The voltage at TCAP acts as the reference voltage of the linear regulator. The boost converter's reference is also based on TCAP with additional fixed voltage to generate 0.8 V above the output.

The charging and discharging current is 10  $\mu$ A, thus the transition time can be calculated as:

$$T_{\text{cad}}(\text{ms}) = 0.5 \cdot \frac{C_{\text{SS}}(\text{nF})}{I_{\text{SS}}(\mu\text{A})} \quad (2)$$

A 22-nF capacitor generates 1.1-ms transition time.

In light load conditions, when LNB output voltage is set from 18 V to 13 V, the voltage might drops very slow, which might cause wrong logic detection at LNB side. TPS65233 has the integrated a pull down circuit to pull down the output during the transition. This will ensure the voltage change can follow the voltage at TCAP. Meanwhile, when 22-kHz tone signal is superimposing on the LNB output voltage, the pull down current can also provide square wave instead of a distorted waveforms, which could cause another detection problem.

## Capacitor Selection

TPS65233 works fine with all ceramic capacitors. Two 22- $\mu$ F, 35-V capacitors can be put at the output of the boost converter. If lower cost is demanded, a 100- $\mu$ F electrolytic and a 1- $\mu$ F ceramic capacitor work well also.

## Short Circuit Protection, Hiccup and Over Temperature Protection

The LNB output limit can be set by an external resistor. When short circuit conditions occur, the output current is clamped at the current limit for 4 ms. If the condition remains, the converter will shut down for 128 ms and then try restart. This hiccup behavior prevents the IC from overheating.

The low side MOSFET of the boost converter has a current limit threshold at 3.2 A, which serves as secondary protection. If the boost converter's peak current limit is triggered, the peak current will clamp at 3.2 A. If loading current continues to increase, output voltage starts to drop and output power drops.

Thermal shutdown prevents the chip from operating at exceedingly high temperatures. When the silicon die temperature exceeds 160°C, the output shuts down. When the temperature drops below its lower threshold, typically 140°C, the output is enabled.

When the chip is in over current protection or thermal shutdown, the I<sup>2</sup>C interface and some logic are still active. The Fault pin is pulled down to signal the processor. The Fault pin signal will remain low unless the following actions are taken:

1. If I<sup>2</sup>C interface is not used to control, Enable pin must be recycled in order to pull Fault pin back to high.
2. If I<sup>2</sup>C interface is used, the I<sup>2</sup>C master needs to read the OCP or OTP bit in the register, then the Fault pin returns to high.

## Tone Generation

A 22-kHz tone signal is superimposed at the LNB output voltage as a carrier for DiSEqC command. This tone signal can be generated by feeding an external 22-kHz clock at the EXTM pin. It can also be generated with its internal tone generator gated by control logic. The output stage of the regulator facilitates a push-pull circuit, so even at zero loading the 22-kHz tone at the output is still clear of distortion.

There are four ways to generate the 22-kHz tone signal at the output.

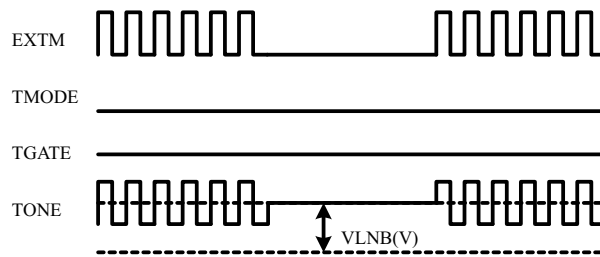

Option 1, Use external tone

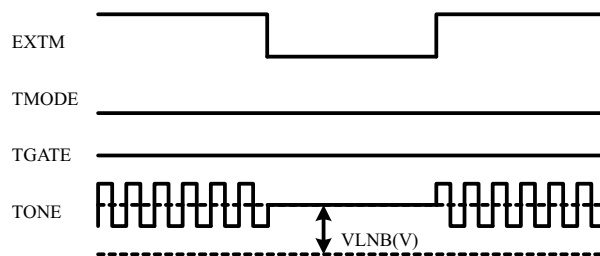

Option 2, Use internal tone, gated by EXTM logic

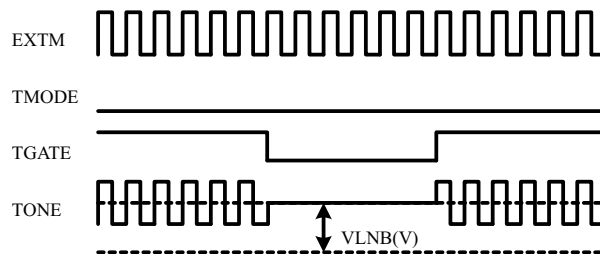

Option 3, Use external tone, gated by TGATE

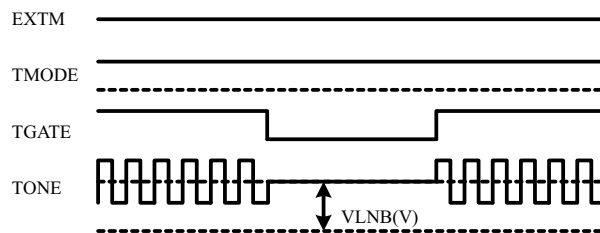

Option 4, Use internal tone, gated by TGATE

**Figure 52. Four Ways to Generate 22-kHz Tone**

### Serial Interface Description

I<sup>2</sup>C is a 2-wire serial interface developed by Philips Semiconductor (see I<sup>2</sup>C-Bus Specification, Version 2.1, January 2000). The bus consists of a data line (SDA) and a clock line (SCL) with pull-up structures. When the bus is idle, both SDA and SCL lines are pulled high. All the I<sup>2</sup>C compatible devices connect to the I<sup>2</sup>C bus through open drain I/O pins, SDA and SCL. A master device, usually a microcontroller or a digital signal processor, controls the bus. The master is responsible for generating the SCL signal and device addresses. The master also generates specific conditions that indicate the START and STOP of data transfer. A slave device receives and transmits data on the bus under control of the master device.

The TPS65233 device works as a slave and supports the following data transfer modes, as defined in the I<sup>2</sup>C-Bus Specification: standard mode (100 kbps), and fast mode (400 kbps). The interface adds flexibility to the power supply solution, enabling most functions to be programmed to new values depending on the instantaneous application requirements. Register contents remain intact as long as supply voltage remains above 4.5 V (typical).

The data transfer protocol for standard and fast modes is exactly the same; therefore, they are referred to as F/S-mode in this document. The TPS65233 device supports 7-bit addressing; 10-bit addressing and general call address are not supported.

The TPS65233 device has a 7-bit address with the 2 LSB bits set by EN pin. Connecting EN to ground set the address 0x60H, connecting to high set the address 0x61H.

**Table 1. I<sup>2</sup>C Address Selection**

EN/ADDR PIN	I <sup>2</sup> C ADDRESS
Connect to Ground	0x60H
Connect to High	0x61H

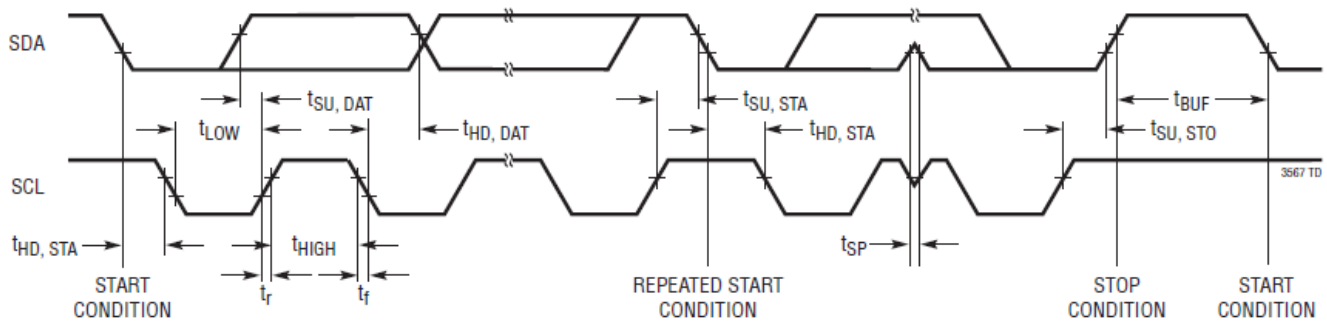
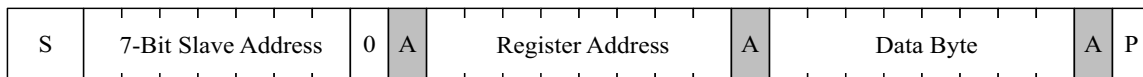

**Figure 53. I<sup>2</sup>C Interface Timing Diagram**

### TPS65233 I<sup>2</sup>C Update Sequence

The TPS65233 requires a start condition, a valid I<sup>2</sup>C address, a register address byte, and a data byte for a single update. After the receipt of each byte, TPS65233 device acknowledges by pulling the SDA line low during the high period of a single clock pulse. TPS65233 performs an update on the falling edge of the LSB byte.

When the TPS65233 is disabled (EN pin tied to ground) the device can still be updated via the I<sup>2</sup>C interface.



**Figure 54. I<sup>2</sup>C Write Data Format**

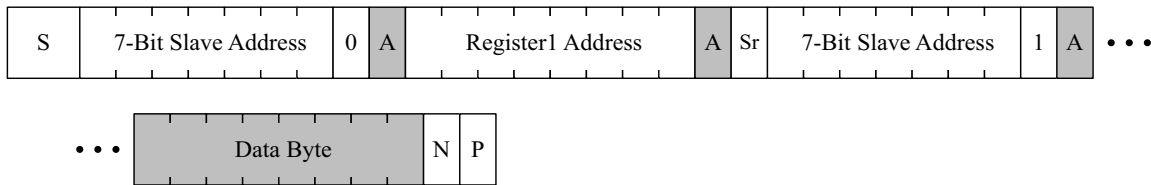

Figure 55. I<sup>2</sup>C Read Data Format

A: Acknowledge  
 N: Not Acknowledge  
 S: Start  
 P: Stop  
 Sr: Repeated Start

System Host  
 Chip

Register Description

Register descriptions are shown below tables.

Table 2. Control Register 1

	NO. OF BITS	ACCESS	NAME	DEFAULT VALUE	DESCRIPTION
Control Register	Bit 8				
address: 0x00H	Bit 7	R/W	I2C_CON	0	1: I <sup>2</sup> C control enabled; 0: I <sup>2</sup> C control disabled
	Bit 6	R/W		0	reserved
	Bit 5	R/W	TGATE	0	Tone Gate. Allows either the internal or external 22-kHz tone signals to be gated. 1: Tone Gate on, 0: Tone gate off
	Bit 4	R/W	TMODE	0	Tone mode. Select between the use of an external 22-kHz or internal 22-kHz signal. 1: internal; 0: external
	Bit 3	R/W	EN	1	LNB output voltage Enable 1: output enabled; 0: output disabled
Bit 1	Bit 2	R/W	VSEL2	0	See Table 3 for output voltage selection
	R/W	VSEL1	0		
	Bit 0	R/W			

Table 3. Voltage Selection Bits

VSEL2	VSEL1	VSEL0	LNB(V)
0	0	0	13
0	0	1	13.4
0	1	0	13.8
0	1	1	14.2
1	0	0	18
1	0	1	18.6
1	1	0	19.2
1	1	1	19.8

**Table 4. Control Register 2**

	NO. OF BITS	ACCESS	NAME	DEFAULT VALUE	DESCRIPTION
Control Register	Bit 8				
address: 0x01H	Bit 7	R/W			
	Bit 6	R/W			
	Bit 5	R/W			
	Bit 4	R/W	TONE_POS1	0	00: tone above Vout; 01: tone in the middle of Vout; 10: tone below Vout
	Bit 3	R/W	TONE_POS0	1	
	Bit 2	R/W	CL1	0	Current limit set bits
	Bit 1	R/W	CL0	0	
	Bit 0	R/W	CL_EXT	1	1: current limit set by external resistor; 0: current limit set by register

Some tone detection circuits in LNB is sensitive to the position of the tone on the output voltage. TPS65233 provides options to selection the position by setting the TONE\_POS1 and TONE\_POS0 bits, as illustrated below.



*Option 1, TONE\_POS1=0, TONE\_POS0=0, Tone above VLNB*

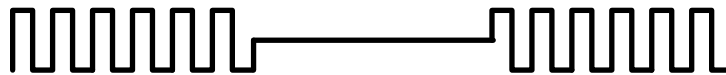

*Option 2, TONE\_POS1=0, TONE\_POS0=1, Tone in the middle of VLNB*

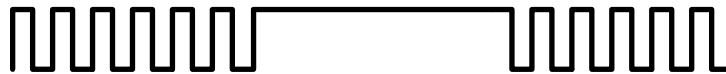

*Option 2, TONE\_POS1=1, TONE\_POS0=0, Tone below VLNB*

**Figure 56. Tone Position Programmed by TONE\_POS1, TONE\_POS0 Bits**

In addition to program the LDO's current continuously via an external resistor, internal registers also provide options to program the current limit. There are four options can be selected.

**Table 5. Current Limit Selection Bits**

CL1	CL0	CURRENT LIMIT (mA)
0	0	400
0	1	600
1	0	750
1	1	1000

TPS65233 has full range of diagnostic flags for operation and debug. If any of the flags are triggered, pin FAULT will be pulled low, sending an interrupt signal to processor. Processor then can read the status register to check the error conditions. Status bits are described as follow. Among these bits, TSD and OCP are different from others. Once TSD and OCP are set to "1", the Fault pin logic is latched to low, processor need to reset the bits in order to release the fault conditions. Other bits will change as conditions change without latch.

**Table 6. Status Register 1**

	NO. OF BITS	ACCESS	NAME	DEFAULT VALUE	DESCRIPTION
Status Register	Bit 8				
address: 0x02H	Bit 7				
	Bit 6	R	T125	0	1: if die temperature T>125°C; 0: if die temperature T<125°C;
	Bit 5	R	LDO_ON	0	1: internal LDO is turned on and boost converter is on; 0: Internal LDO is turned off but boost converter is on
	Bit 4	R		0	reserved
	Bit 3	R	TSD	0	1: thermal shutdown occurs; 0: thermal shutdown does not occur. FAULT pin pull low and latch, I <sup>2</sup> C master need to read and release
	Bit 2	R	OCP	0	Over current protection. If over current conditions last for more than 48ms. 1: over current protection triggered. 0: over current protection conditions released. FAULT pin pull low and latch, I <sup>2</sup> C master need to read and release
	Bit 1	R	CABLE_GOOD	0	Cable connection good. 1: output current above 50 mA; 0: output current less than 50 mA.
	Bit 0	R	VOUT_GOOD	0	LNB output voltage in range. 1: in range; 0: out of range

### Layout Recommendation

TPS65233 is designed to layout in a 2-layer PCB. The following illustration shows the recommended layout practice. It's critical to make sure the GND of input cap, output cap and the boost converter are connected at one point at same layer as shown below. PGND and AGND are in different region. They are connected to thermal pad. Other components are connected AGND.

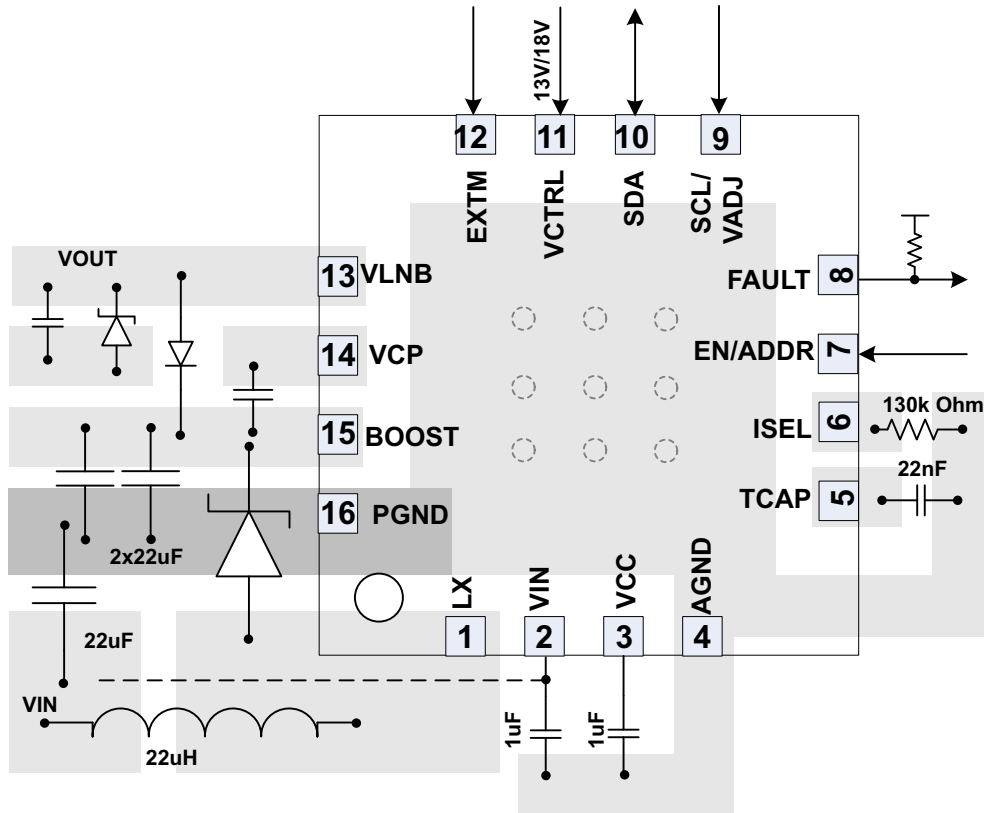

Figure 57. 2-Layer PCB Layout



**PACKAGING INFORMATION**

Orderable Device	Status (1)	Package Type	Package Drawing	Pins	Package Qty	Eco Plan (2)	Lead/Ball Finish (6)	MSL Peak Temp (3)	Op Temp (°C)	Device Marking (4/5)	Samples
TPS65233RTER	ACTIVE	WQFN	RTE	16	3000	Green (RoHS & no Sb/Br)	CU NIPDAU	Level-2-260C-1 YEAR	-40 to 85	65233	<a href="#">Samples</a>
TPS65233RTET	ACTIVE	WQFN	RTE	16	250	Green (RoHS & no Sb/Br)	CU NIPDAU	Level-2-260C-1 YEAR	-40 to 85	65233	<a href="#">Samples</a>

(1) The marketing status values are defined as follows:

**ACTIVE:** Product device recommended for new designs.

**LIFEBUY:** TI has announced that the device will be discontinued, and a lifetime-buy period is in effect.

**NRND:** Not recommended for new designs. Device is in production to support existing customers, but TI does not recommend using this part in a new design.

**PREVIEW:** Device has been announced but is not in production. Samples may or may not be available.

**OBSOLETE:** TI has discontinued the production of the device.

(2) Eco Plan - The planned eco-friendly classification: Pb-Free (RoHS), Pb-Free (RoHS Exempt), or Green (RoHS & no Sb/Br) - please check <http://www.ti.com/productcontent> for the latest availability information and additional product content details.

**TBD:** The Pb-Free/Green conversion plan has not been defined.

**Pb-Free (RoHS):** TI's terms "Lead-Free" or "Pb-Free" mean semiconductor products that are compatible with the current RoHS requirements for all 6 substances, including the requirement that lead not exceed 0.1% by weight in homogeneous materials. Where designed to be soldered at high temperatures, TI Pb-Free products are suitable for use in specified lead-free processes.

**Pb-Free (RoHS Exempt):** This component has a RoHS exemption for either 1) lead-based flip-chip solder bumps used between the die and package, or 2) lead-based die adhesive used between the die and leadframe. The component is otherwise considered Pb-Free (RoHS compatible) as defined above.

**Green (RoHS & no Sb/Br):** TI defines "Green" to mean Pb-Free (RoHS compatible), and free of Bromine (Br) and Antimony (Sb) based flame retardants (Br or Sb do not exceed 0.1% by weight in homogeneous material)

(3) MSL, Peak Temp. - The Moisture Sensitivity Level rating according to the JEDEC industry standard classifications, and peak solder temperature.

(4) There may be additional marking, which relates to the logo, the lot trace code information, or the environmental category on the device.

(5) Multiple Device Markings will be inside parentheses. Only one Device Marking contained in parentheses and separated by a "~" will appear on a device. If a line is indented then it is a continuation of the previous line and the two combined represent the entire Device Marking for that device.

(6) Lead/Ball Finish - Orderable Devices may have multiple material finish options. Finish options are separated by a vertical ruled line. Lead/Ball Finish values may wrap to two lines if the finish value exceeds the maximum column width.

**Important Information and Disclaimer:** The information provided on this page represents TI's knowledge and belief as of the date that it is provided. TI bases its knowledge and belief on information provided by third parties, and makes no representation or warranty as to the accuracy of such information. Efforts are underway to better integrate information from third parties. TI has taken and continues to take reasonable steps to provide representative and accurate information but may not have conducted destructive testing or chemical analysis on incoming materials and chemicals. TI and TI suppliers consider certain information to be proprietary, and thus CAS numbers and other limited information may not be available for release.

In no event shall TI's liability arising out of such information exceed the total purchase price of the TI part(s) at issue in this document sold by TI to Customer on an annual basis.

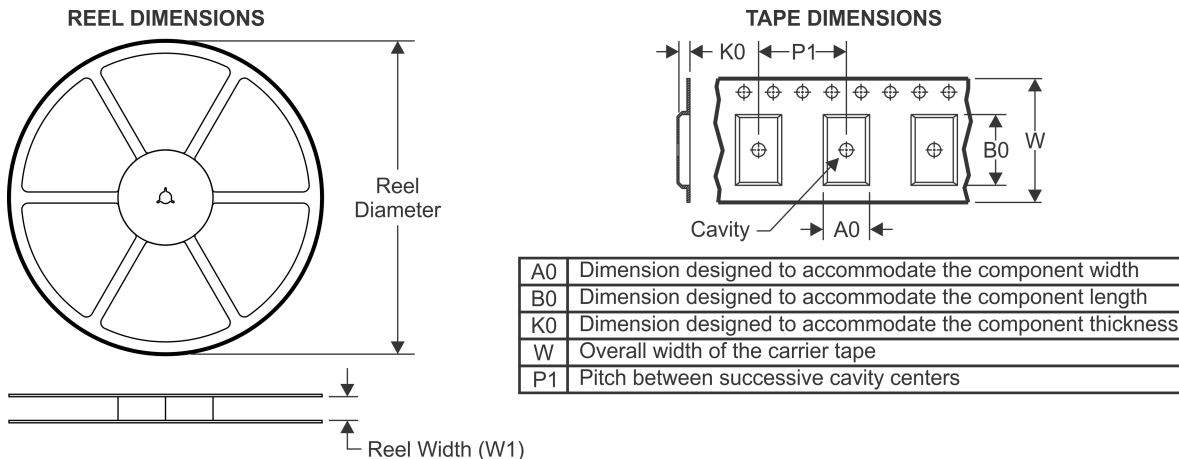
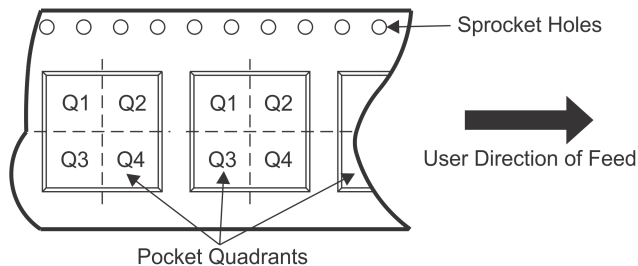
**TAPE AND REEL INFORMATION**

**QUADRANT ASSIGNMENTS FOR PIN 1 ORIENTATION IN TAPE**

\*All dimensions are nominal

Device	Package Type	Package Drawing	Pins	SPQ	Reel Diameter (mm)	Reel Width W1 (mm)	A0 (mm)	B0 (mm)	K0 (mm)	P1 (mm)	W (mm)	Pin1 Quadrant
TPS65233RTER	WQFN	RTE	16	3000	330.0	12.4	3.3	3.3	1.1	8.0	12.0	Q2
TPS65233RTET	WQFN	RTE	16	250	180.0	12.4	3.3	3.3	1.1	8.0	12.0	Q2

**TAPE AND REEL BOX DIMENSIONS**



\*All dimensions are nominal

Device	Package Type	Package Drawing	Pins	SPQ	Length (mm)	Width (mm)	Height (mm)
TPS65233RTER	WQFN	RTE	16	3000	367.0	367.0	35.0
TPS65233RTET	WQFN	RTE	16	250	210.0	185.0	35.0

# MECHANICAL DATA

RTE (S-PWQFN-N16)

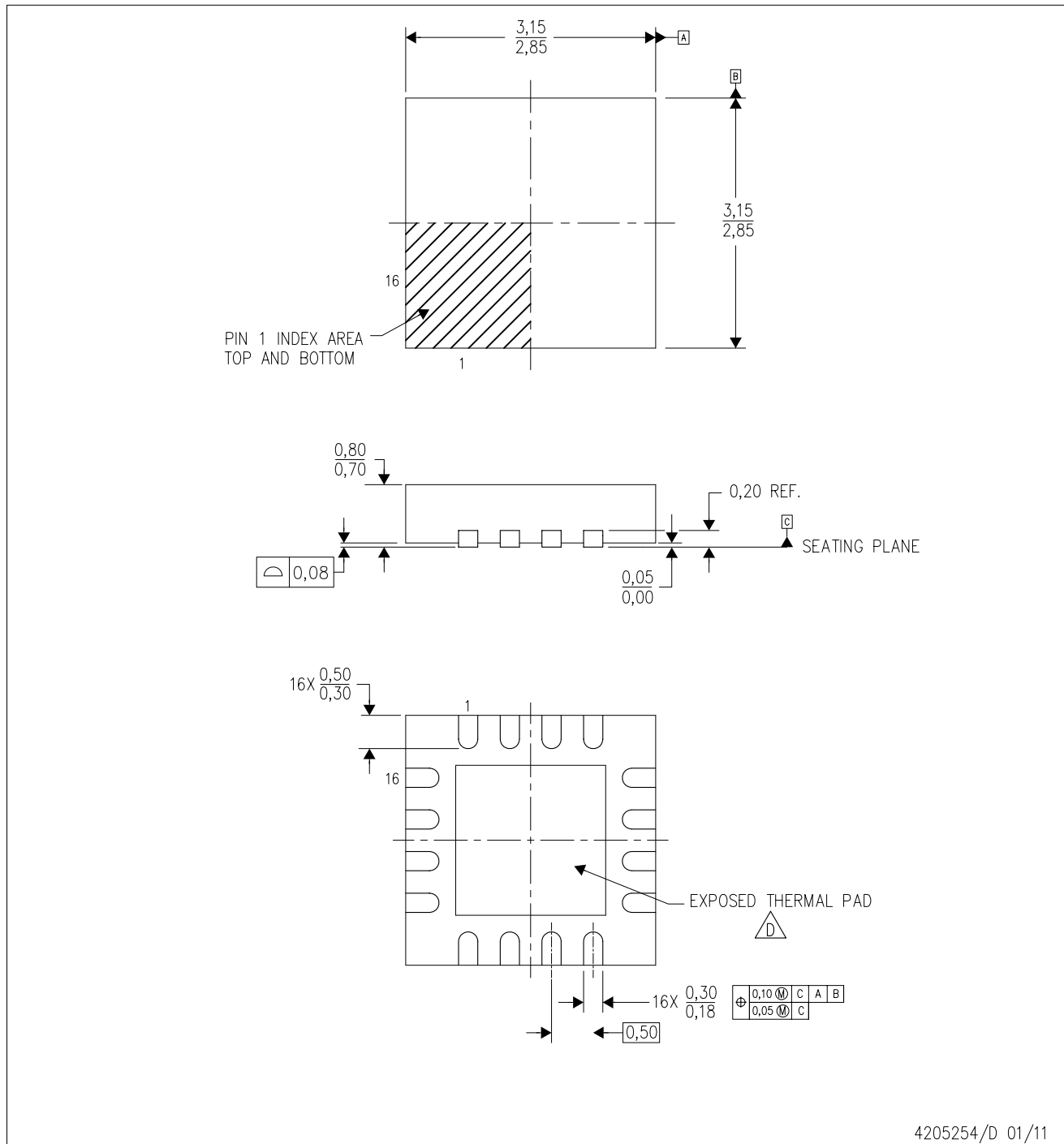
PLASTIC QUAD FLATPACK NO-LEAD



4205254/D 01/11

- NOTES:
- A. All linear dimensions are in millimeters. Dimensioning and tolerancing per ASME Y14.5M-1994.
  - B. This drawing is subject to change without notice.
  - C. Quad Flatpack, No-leads (QFN) package configuration.
  -  The package thermal pad must be soldered to the board for thermal and mechanical performance. See the Product Data Sheet for details regarding the exposed thermal pad dimensions.
  - E. Falls within JEDEC MO-220.

## THERMAL PAD MECHANICAL DATA

RTE (S-PWQFN-N16)

PLASTIC QUAD FLATPACK NO-LEAD

### THERMAL INFORMATION

This package incorporates an exposed thermal pad that is designed to be attached directly to an external heatsink. The thermal pad must be soldered directly to the printed circuit board (PCB). After soldering, the PCB can be used as a heatsink. In addition, through the use of thermal vias, the thermal pad can be attached directly to the appropriate copper plane shown in the electrical schematic for the device, or alternatively, can be attached to a special heatsink structure designed into the PCB. This design optimizes the heat transfer from the integrated circuit (IC).

For information on the Quad Flatpack No-Lead (QFN) package and its advantages, refer to Application Report, QFN/SON PCB Attachment, Texas Instruments Literature No. SLUA271. This document is available at [www.ti.com](http://www.ti.com).

The exposed thermal pad dimensions for this package are shown in the following illustration.

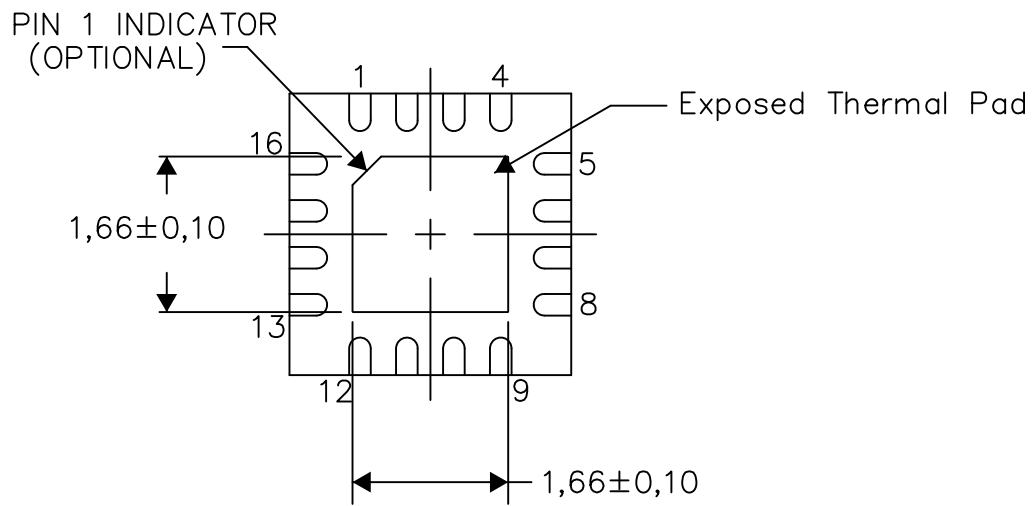

Bottom View

Exposed Thermal Pad Dimensions

4206446-8/U 08/15

NOTE: A. All linear dimensions are in millimeters

RTE (S-PWQFN-N16)

PLASTIC QUAD FLATPACK NO-LEAD

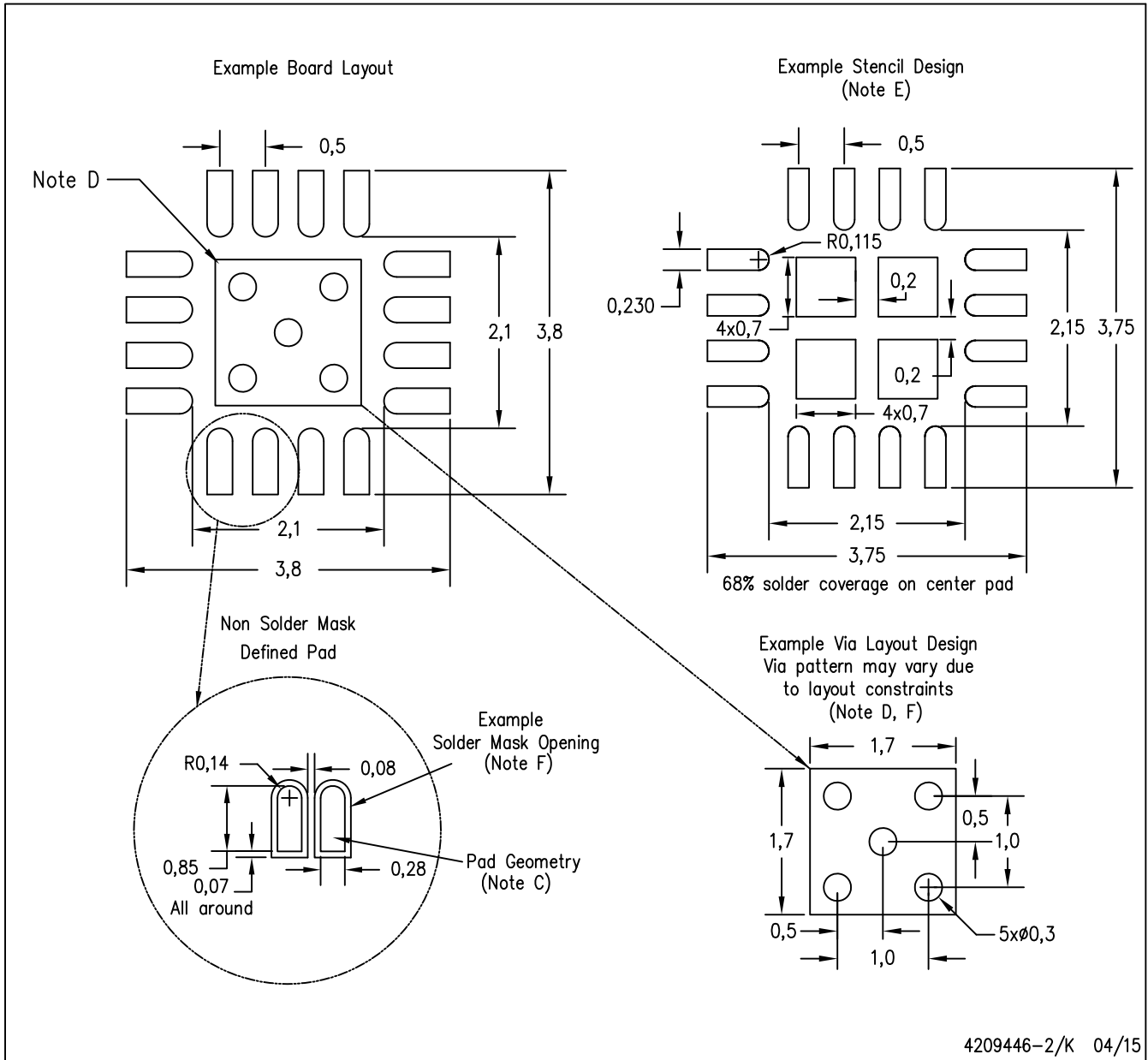

- NOTES:
- All linear dimensions are in millimeters.
  - This drawing is subject to change without notice.
  - Publication IPC-7351 is recommended for alternate designs.
  - This package is designed to be soldered to a thermal pad on the board. Refer to Application Note, Quad Flat-Pack Packages, Texas Instruments Literature No. SLUA271, and also the Product Data Sheets for specific thermal information, via requirements, and recommended board layout. These documents are available at [www.ti.com](http://www.ti.com) <<http://www.ti.com>>.
  - Laser cutting apertures with trapezoidal walls and also rounding corners will offer better paste release. Customers should contact their board assembly site for stencil design recommendations. Refer to IPC 7525 for stencil design considerations.
  - Customers should contact their board fabrication site for minimum solder mask web tolerances between signal pads.

## IMPORTANT NOTICE

Texas Instruments Incorporated and its subsidiaries (TI) reserve the right to make corrections, enhancements, improvements and other changes to its semiconductor products and services per JESD46, latest issue, and to discontinue any product or service per JESD48, latest issue. Buyers should obtain the latest relevant information before placing orders and should verify that such information is current and complete. All semiconductor products (also referred to herein as "components") are sold subject to TI's terms and conditions of sale supplied at the time of order acknowledgment.

TI warrants performance of its components to the specifications applicable at the time of sale, in accordance with the warranty in TI's terms and conditions of sale of semiconductor products. Testing and other quality control techniques are used to the extent TI deems necessary to support this warranty. Except where mandated by applicable law, testing of all parameters of each component is not necessarily performed.

TI assumes no liability for applications assistance or the design of Buyers' products. Buyers are responsible for their products and applications using TI components. To minimize the risks associated with Buyers' products and applications, Buyers should provide adequate design and operating safeguards.

TI does not warrant or represent that any license, either express or implied, is granted under any patent right, copyright, mask work right, or other intellectual property right relating to any combination, machine, or process in which TI components or services are used. Information published by TI regarding third-party products or services does not constitute a license to use such products or services or a warranty or endorsement thereof. Use of such information may require a license from a third party under the patents or other intellectual property of the third party, or a license from TI under the patents or other intellectual property of TI.

Reproduction of significant portions of TI information in TI data books or data sheets is permissible only if reproduction is without alteration and is accompanied by all associated warranties, conditions, limitations, and notices. TI is not responsible or liable for such altered documentation. Information of third parties may be subject to additional restrictions.

Resale of TI components or services with statements different from or beyond the parameters stated by TI for that component or service voids all express and any implied warranties for the associated TI component or service and is an unfair and deceptive business practice. TI is not responsible or liable for any such statements.

Buyer acknowledges and agrees that it is solely responsible for compliance with all legal, regulatory and safety-related requirements concerning its products, and any use of TI components in its applications, notwithstanding any applications-related information or support that may be provided by TI. Buyer represents and agrees that it has all the necessary expertise to create and implement safeguards which anticipate dangerous consequences of failures, monitor failures and their consequences, lessen the likelihood of failures that might cause harm and take appropriate remedial actions. Buyer will fully indemnify TI and its representatives against any damages arising out of the use of any TI components in safety-critical applications.

In some cases, TI components may be promoted specifically to facilitate safety-related applications. With such components, TI's goal is to help enable customers to design and create their own end-product solutions that meet applicable functional safety standards and requirements. Nonetheless, such components are subject to these terms.

No TI components are authorized for use in FDA Class III (or similar life-critical medical equipment) unless authorized officers of the parties have executed a special agreement specifically governing such use.

Only those TI components which TI has specifically designated as military grade or "enhanced plastic" are designed and intended for use in military/aerospace applications or environments. Buyer acknowledges and agrees that any military or aerospace use of TI components which have **not** been so designated is solely at the Buyer's risk, and that Buyer is solely responsible for compliance with all legal and regulatory requirements in connection with such use.

TI has specifically designated certain components as meeting ISO/TS16949 requirements, mainly for automotive use. In any case of use of non-designated products, TI will not be responsible for any failure to meet ISO/TS16949.

### Products

Audio	<a href="http://www.ti.com/audio">www.ti.com/audio</a>
Amplifiers	<a href="http://amplifier.ti.com">amplifier.ti.com</a>
Data Converters	<a href="http://dataconverter.ti.com">dataconverter.ti.com</a>
DLP® Products	<a href="http://www.dlp.com">www.dlp.com</a>
DSP	<a href="http://dsp.ti.com">dsp.ti.com</a>
Clocks and Timers	<a href="http://www.ti.com/clocks">www.ti.com/clocks</a>
Interface	<a href="http://interface.ti.com">interface.ti.com</a>
Logic	<a href="http://logic.ti.com">logic.ti.com</a>
Power Mgmt	<a href="http://power.ti.com">power.ti.com</a>
Microcontrollers	<a href="http://microcontroller.ti.com">microcontroller.ti.com</a>
RFID	<a href="http://www.ti-rfid.com">www.ti-rfid.com</a>
OMAP Applications Processors	<a href="http://www.ti.com/omap">www.ti.com/omap</a>
Wireless Connectivity	<a href="http://www.ti.com/wirelessconnectivity">www.ti.com/wirelessconnectivity</a>

### Applications

Automotive and Transportation	<a href="http://www.ti.com/automotive">www.ti.com/automotive</a>
Communications and Telecom	<a href="http://www.ti.com/communications">www.ti.com/communications</a>
Computers and Peripherals	<a href="http://www.ti.com/computers">www.ti.com/computers</a>
Consumer Electronics	<a href="http://www.ti.com/consumer-apps">www.ti.com/consumer-apps</a>
Energy and Lighting	<a href="http://www.ti.com/energy">www.ti.com/energy</a>
Industrial	<a href="http://www.ti.com/industrial">www.ti.com/industrial</a>
Medical	<a href="http://www.ti.com/medical">www.ti.com/medical</a>
Security	<a href="http://www.ti.com/security">www.ti.com/security</a>
Space, Avionics and Defense	<a href="http://www.ti.com/space-avionics-defense">www.ti.com/space-avionics-defense</a>
Video and Imaging	<a href="http://www.ti.com/video">www.ti.com/video</a>

### TI E2E Community

[e2e.ti.com](http://e2e.ti.com)