

Switch

Slide Switch Series

KLS7-SS01-12E09 (1P2T) Slide Switch Series

SPECIFICATIONS

- Rating: 0.3A 50VDC
- Contact Resistance: 50MΩ max
- Insulation Resistance: 500VDC 100MΩ Min
- Dielectric Strength: 100V AC 1 Minute
- Operating Force: 100gf~800gf
- Electrical Life : 10,000 cycles

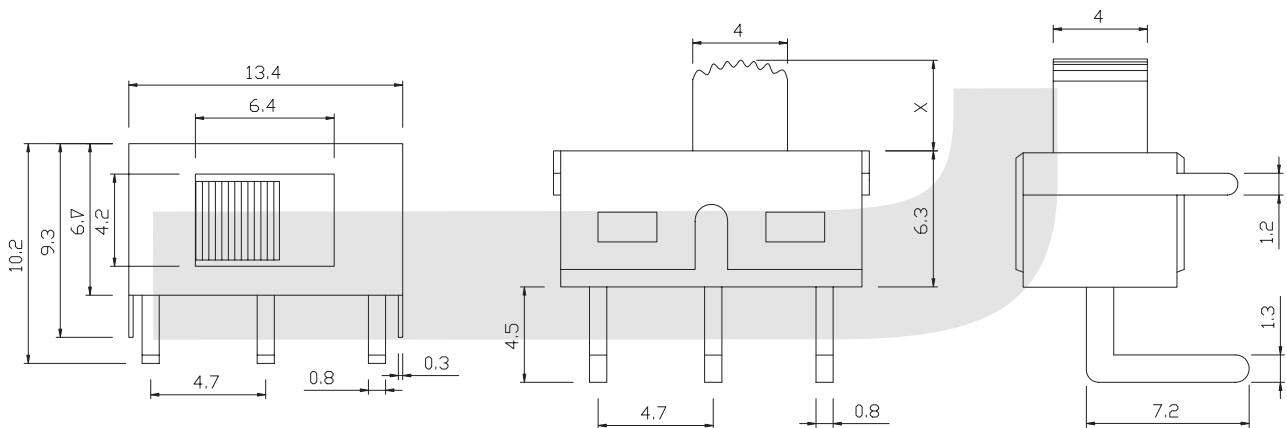

ORDER INFORMATION

KLS7-SS01 - 1 2 E 09 - X X - X

- Part Number
- Slide Switch Type
- Pole
- Throw
- Operating Force
- Knobe Height
- Sequential No.

Travelling					
C	D	E	F	G	H
1.5	2.0	2.5	3.0	3.5	4.0
I	J	K	L	N	P
4.5	5.0	5.5	6.0	7.0	8.0

