

1W isolated DC-DC converter
Fixed input voltage, unregulated single output

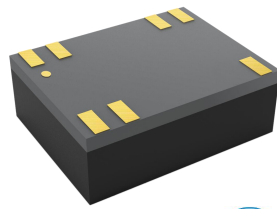

UL **CE** **CB** Patent Protection **RoHS**

FEATURES

- Ultra-small, ultra-thin DFN package (9.00 x 7.00 x 3.10mm)
- Isolation capacitance as low as 8pF
- I/O isolation test voltage 3k VDC
- Operating ambient temperature range: -40°C to +125°C
- High efficiency up to 85%
- Continuous short-circuit protection
- IEC62368/UL62368/EN62368 approved
- AEC-Q100 approved

B05xxMT-1WR4 series are specially designed for applications where an isolated voltage is required in a distributed power supply system and especially suitable in applications such as digital circuits, low frequency analog circuits, relay-driven circuits and data switching circuits.

Selection Guide

Certification	Part No.	Input Voltage (VDC)	Output		Full Load Efficiency (%) Min./Typ.	Capacitive Load(μF) Max.
		Nominal (Range)	Voltage (VDC)	Current(mA) Max./Min.		
UL/CE/CB	B0505MT-1WR4	5 (4.5-5.5)	5	200/20	81/85	2400

Input Specifications

Item	Operating Conditions	Min.	Typ.	Max.	Unit
Input Current (full load / no-load)	5VDC input	--	235/7	247/15	mA
Reflected Ripple Current*		--	10	--	mA
Surge Voltage (1sec. max.)	5VDC input	-0.7	--	9	VDC
Input Filter		Capacitance filter			
Hot Plug		Unavailable			

Note: * Please refer to DC-DC Converter Application Note for detailed description of reflected ripple current testing method.

Output Specifications

Item	Operating Conditions	Min.	Typ.	Max.	Unit
Voltage Accuracy		See output regulation curve (Fig. 1)			
Linear Regulation	Input voltage change: ±1%	--	--	1.2	--
Load Regulation	10%-100% load	--	8	15	%
Ripple & Noise*	20MHz bandwidth	--	30	75	mVp-p
Temperature Coefficient	Full load	--	±0.02	--	%/°C
Short-circuit Protection		Continuous, self-recovery			

Note: * The "parallel cable" method is used for ripple and noise test, please refer to DC-DC Converter Application Notes for specific information.

General Specifications

Item	Operating Conditions	Min.	Typ.	Max.	Unit
Isolation	Input-output electric strength test for 1 minute with a leakage current of 1mA max.	3000	--	--	VDC
		1500	--	--	VAC
Insulation Resistance	Input-output resistance at 500VDC	1000	--	--	MΩ
Isolation Capacitance	Input-output capacitance at 100kHz/0.1V	--	8	--	pF
Operating Temperature	Derating when operating temperature ≥ 105°C, (see Fig. 2)	-40	--	125	°C

Storage Temperature		-55	--	125	°C
Case Temperature Rise	Ta=25°C	--	10	--	
Storage Humidity	Non-condensing	--	--	95	%RH
Reflow Soldering Temperature*		Peak temp. ≤245°C, maximum duration time ≤60s over 217°C			
Vibration		10-150Hz, 0.75mm, 5G, 90Min. along X, Y and Z			
Switching Frequency	Full load, nominal input voltage	--	300	--	kHz
MTBF	MIL-HDBK-217F@25°C	7500	--	--	k hours
Moisture Sensitivity Level (MSL)	IPC/JEDEC J-STD-020D.1	Level 3			

Note: * See also IPC/JEDEC J-STD-020D.1.

Mechanical Specifications

Case Material	Black epoxy resin; flame-retardant and heat-resistant (UL94 V-0)
Dimensions	9.00 x 7.00 x 3.10 mm
Weight	0.5(Typ.)
Cooling Method	Free air convection

Electromagnetic Compatibility (EMC)

Emissions	CE	CISPR32/EN55032	CLASS B (see Fig. 4 for recommended circuit)
	RE	CISPR32/EN55032	CLASS B (see Fig. 4 for recommended circuit)
Immunity	ESD	IEC/EN61000-4-2	Contact ±8kV perf. Criteria B
	RS	IEC/EN61000-4-3	10V/m perf. Criteria A
	CS	IEC/EN61000-4-6	3Vr.m.s perf. Criteria A

Typical Characteristic Curves

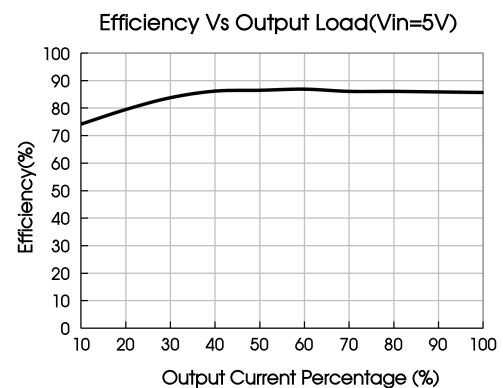
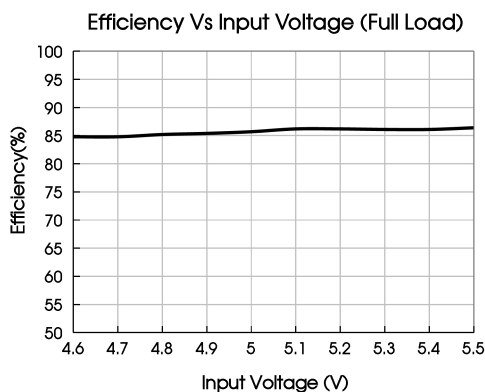
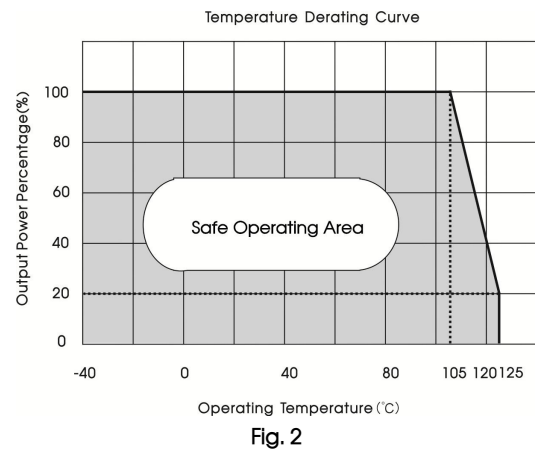
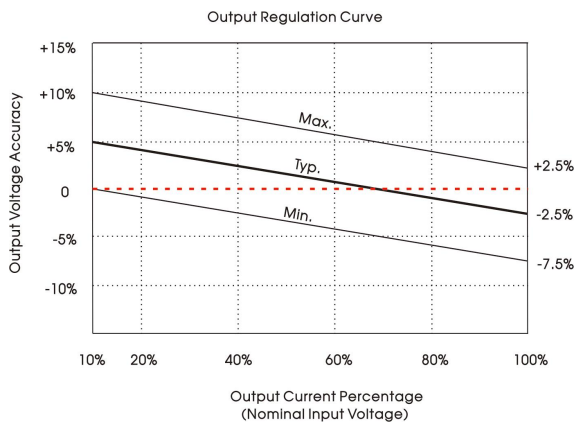

Design Reference

1. Typical application

Input and/or output ripple can be further reduced, by connecting a filter capacitor from the input and/or output terminals to ground as shown in Fig.3.

Choosing suitable filter capacitor values is very important for a smooth operation of the modules. For recommended input and output capacitor values refer to Table 1.

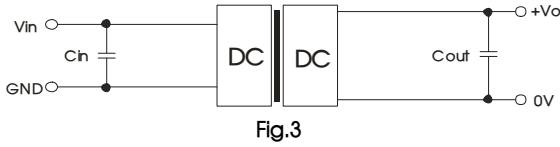

Fig.3

Table 1: Recommended input and output capacitor values

Vin(VDC)	Cin(μF)	Vo (VDC)	Cout(μF)
5	4.7	5	10

2. EMC (CLASS B) compliance circuit

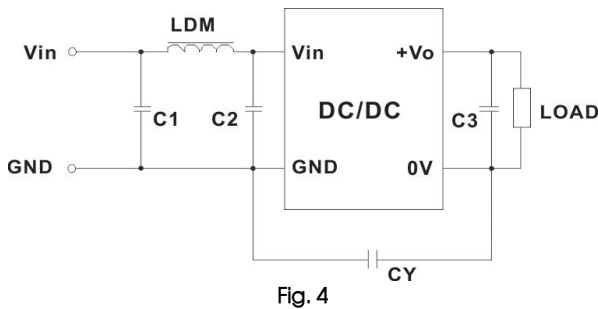

Fig. 4

Table 2: Recommended EMC filter values

Input voltage 5VDC	Output voltage(VDC)		5
	Emissions	C1/C2	4.7μF /25V
		CY	47pF/4KVDC
		C3	Refer to the Cout in table 1
LDM		6.8μH	

3. For additional information, please refer to DC-DC converter application notes on www.mornsun-power.com

Dimensions and Recommended Layout

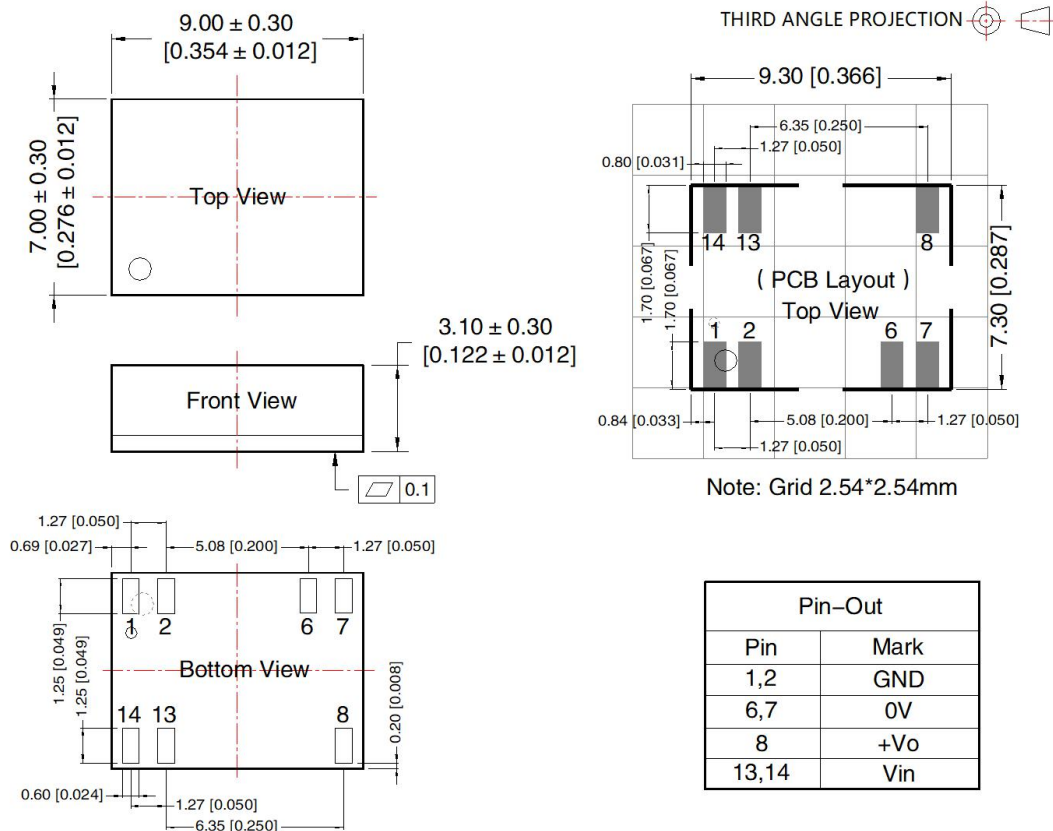

Pin-Out	
Pin	Mark
1,2	GND
6,7	0V
8	+Vo
13,14	Vin

Note:
Unit: mm[inch]
Pin diameter tolerances: ± 0.10[± 0.004]

Tape/Reel packaging

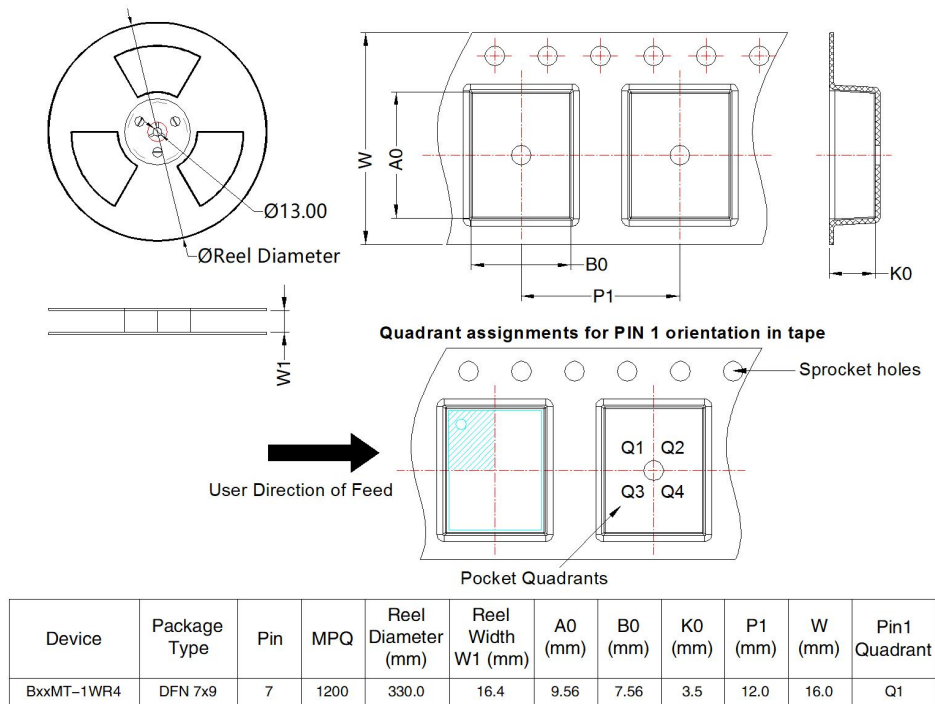

Temperature Rise Test PCB Layout

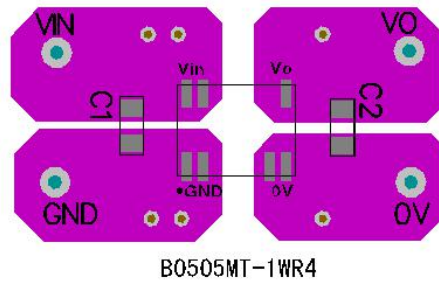

Notes:

- For additional information on Product Packaging please refer to www.mornsun-power.com. Tape/Reel packaging bag number: 58240017;
- Refer to *IPC 7093* for the welding process design of this product. For detailed operation guidance, please refer to *Hot Air Gun Welding Operation Instruction for DFN Package Product* or *Welding Operation Instruction for DFN Package Product*;
- If the product is not operated within the required load range, the product performance cannot be guaranteed to comply with all parameters in the datasheet;
- The maximum capacitive load offered were tested at input voltage range and full load;
- Unless otherwise specified, parameters in this datasheet were measured under the conditions of $T_a=25^{\circ}\text{C}$, humidity<75%RH with nominal input voltage and rated output load;
- All index testing methods in this datasheet are based on our company corporate standards;
- We can provide product customization service, please contact our technicians directly for specific information;
- Products are related to laws and regulations: see "Features" and "EMC";
- Our products shall be classified according to ISO14001 and related environmental laws and regulations, and shall be handled by qualified units.

MORNSUN Guangzhou Science & Technology Co., Ltd.

Address: No. 5, Kehui St. 1, Kehui development center, Science Ave., Guangzhou Science City, Huangpu District, Guangzhou, P. R. China
Tel: 86-20-38601850 Fax: 86-20-38601272 E-mail: info@mornsun.cn www.mornsun-power.com