

Data sheet

Commercial Art.No.: 46.031.4550.6

Connector RST16i3 S B1 ZT4S A TB

RST16i3 connector, 3 pole, female, screw connection, application 250/400V with PE, 16A, for cable diameters 5.0-9.5mm, coding color turquoise blue, color of housing black



Commercial Art.No.	46.031.4550.6
EAN	4049088284250
Order Unit	1

Certificates / Approvals



Technical data

General

Rated current	16 A
Rated voltage	250 V / 400 V
Rated impulse voltage	4 kV
strain relief	yes
Pollution degree	3
Lockable	self-locking (unlocking by hand)
Color of coding/ contact carrier	turquoise blue
Marking of poles	D1, D2, PE
Color of housing inclusive strain relief	black

Connection Data

Cable diameter max.	9.5 mm
Cable diameter min.	5 mm
Connection cross section solid mm ² max.	2.5 mm ²
Connection cross section solid mm ² min.	0.25 mm ²
Connection cross section fine stranded mm ² max.	2.5 mm ²
Connection cross section fine stranded mm ² min.	0.25 mm ²
Terminations per pole	1
sheath strip length	25 mm
Wire strip length	8 mm

Model

Model	female
Connection type	screw connection
Degree of protection (IP)	IP66/68 (3m;2h) /IP69

Material

Housing material	Polyamide
halogen free	yes
Contact material	CuZn
Fire load	0.151 kWh
Insulation components continuous temperature	100 °C
Surface finish	Silver-plated

Dimensions

Length	71 mm
Width	19.9 mm
Height	19.9 mm

Classification

ECLASS 11	
ECLASS 8.1	27440605
ETIM 7.0	EC002560
ETIM 6.0	EC002560
ETIM 5.0	EC002560
ETIM 4.0	EC002560

Note

Note	RST® terminals with screw clamping allow the connection of conductors without special preparation (without ferrules) according to EN 60999-1.
------	---

Product compliance

ROHS conformity status	Compliant/Exempted
ROHS exceptions	III-6(c)
REACH-SVHC conformity status	Duty-To-Declare
REACH-SVHC substances	Lead
REACH-SVHC CAS numbers	7439-92-1

Fits with



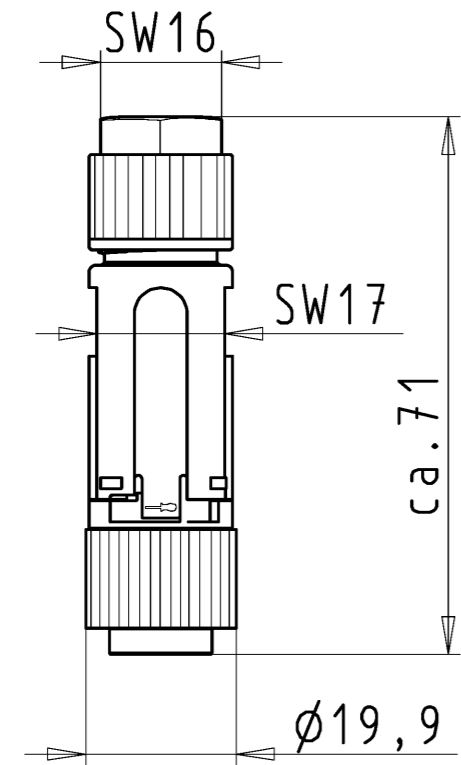

Commercial Art.No.:	Article-type description:	Description:
46.032.4550.6	Connector RST16i3 S S1 ZT4S A TB	RST16i3 connector, 3 pole, male, screw connection, application 250/400V with PE, 16A, for cable diameters 5.0-9.5mm, coding color turquoise blue, color of housing black
46.032.5050.6	Device connector RST16i3 S S1 M02 A TB	RST16i3 device connector M16, 3 pole, male, screw connection, application 250/400V with PE, 16A, coding color turquoise blue
46.030.0150.6	Distributor RST16i3B 3P1 F G V TB	RST16i3 compact distribution unit, 3 pole, application 250/400V with PE, 16 A, 1 input and 3 outputs, fastening option, coding color turquoise blue, color of housing black
46.032.M050.6	Device connector RST16i3 S D03 MTB	RST16i3 modular device connector M20, 3 pole, male, spring clamp connection, with automatic wiring option, application 250/400V with PE, 16A, coding color turquoise blue
46.032.M0L0.6	Device connector RST16i3 2 D03 MTB	RST16i3 modular device connector with longitudinal sealing M20, 3 pole, male, spring clamp connection, with automatic wiring option, application 250/400V with PE, 16A, coding color turquoise blue

46.030.1250.6	Distributor RST16i3V 2P1 TGVGA TB	RST16i3 distribution block, 3 pole, application 250/400V with PE, 16 A, 1 input and 2 outputs, fastening option with separate mounting plate, coding color turquoise blue
---------------	-----------------------------------	---

These dimensions will be especially checked at delivery
 Only inspection dimensions
 With /E marked dimensions are only valid for internal use
 Diese Maße werden bei Abnahme besonders geprüft
 Ausschließlich Prüfmaße
 Mit /E gekennzeichnete Maße sind nur für interne Zwecke gültig



Kodierung
/Coding

-  C1
-  C2
-  C3
-  C4
-  C5

Auslieferungszustand
/delivery condition

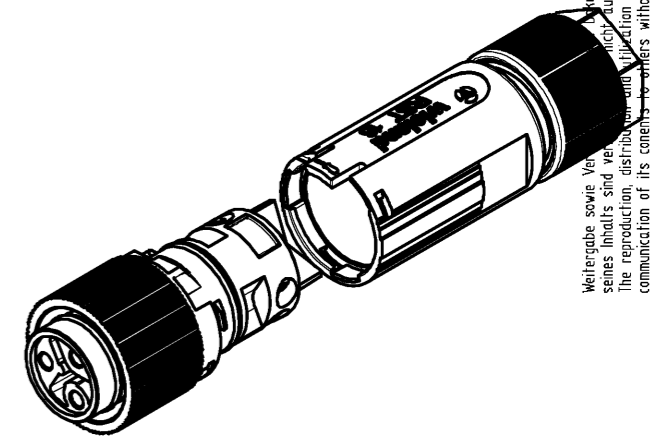
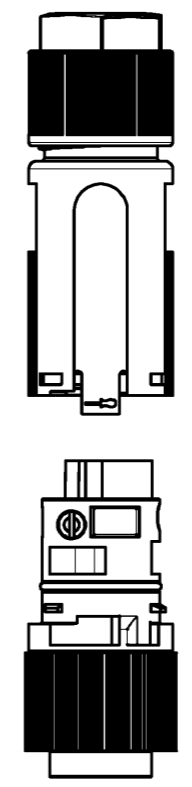

Weitergabe sowie Verwertung des Dokuments, Verwertung und Mitteilung seines Inhalts sind verbotlich.
 The reproduction, distribution and application of this document as well as the communication of its contents to others without express authorization is prohibited.

46.031.4550.6	RST16 I3	S B1 ZT4S A TB	C5	türkisblau /turquoise blue
46.031.4553.9	RST16 I3	S B1 ZT4S H BL	C4	lichtblau /light blue
46.031.4550.4	RST16 I3	S B1 ZT4S L BR	C3	signalbraun /signal brown
46.031.4555.7	RST16 I3	S B1 ZT4S GN	C2	laubgrün /leaf green
46.031.4553.1	RST16 I3	S B1 ZT4 SW	C1	schwarz /black
46.031.4553.0	RST16 I3	S B1 ZT4 GL	C1	lichtgrau /light grey
Bestellnummer /Order number	Typ /Type		Kodierung /Coding	Farbe /Colour
Weitere Daten siehe KATALOG oder eKatalog. Additional data see CATALOG or eCatalog.			www.wieland-electric.com eshop.wieland-electric.com	

Tolerierung Size ISO 14405 (Tolerance system Size ISO 14405).
 (This ISO-standard describes the envelope principle. According to the envelope principle the deviations of form and parallelism are limited by the size tolerances).

ja/yes Stoffverbots- und Deklarationsliste nach WN 5020.010 ist einzuhalten.
 Conformity with Wieland document WN 5020.010 e (list of prohibited / declarable hazardous substances) to be declared!

Freitoleranz nach General tolerance CAD - Zeichnung, keine manuellen Änderungen CAD - drawing, no manual modifications allowed 1. Verwendung: - First Use: - Blatt: 1 von 1 Sheet: of 1

Werkstoff/Material	2014 Tag/Date	Name	Zeichnung Nr./Drawing No.	Index
gezeichnet/drawn	02.09.	Treschan		
geprüft/checked	-	-		
Maßstab/Scale	1:1	Normgepr. Stand. check	Maße in mm/Dimensions are in mm	
Vol. mm ³	Ofl./Surf. mm ²	Ersatz für/Replacement for: -		
a	06.10.2014/	Type	Benennung/Title	
Index	Datum / Blatt Date / Sheet	 wieland	RST16..	BUCHSENTE I L
Änderung/Revision		www.wieland-electric.com	FA - mit Zugentlastung, 3-polig female, with strain relief, 3 poles	