

BC807 TRANSISTOR(PNP)

FEATURES

- Ideally Suited for Automatic Insertion
- Epitaxial Planar Die Construction
- For Switching, AF Driver and Amplifier Applications
- Complementary NPN Types Available (BC817)

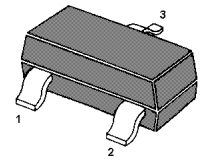

SOT-23

1. BASE 2. EMITTER 3. COLLECTOR

MARKING:BC807-16:5A

BC807-25:5B

BC807-40:5C

MAXIMUM RATINGS ($T_A=25^{\circ}\text{C}$ unless otherwise noted)

Symbol	Parameter	Value	Units
V_{CBO}	Collector-Base Voltage	-50	V
V_{CEO}	Collector-Emitter Voltage	-45	V
V_{EBO}	Emitter-Base Voltage	-5	V
I_C	Collector Current -Continuous	-0.5	A
P_C	Collector Power Dissipation	0.3	W
T_j	Junction Temperature	150	$^{\circ}\text{C}$
T_{stg}	Storage Temperature	-55-150	$^{\circ}\text{C}$

ELECTRICAL CHARACTERISTICS ($T_{amb}=25^{\circ}\text{C}$ unless otherwise specified)

Parameter	Symbol	Test conditions	MIN	MAX	UNIT	
Collector-base breakdown voltage	$V_{(BR)CBO}$	$I_C = -10\mu\text{A}, I_E=0$	-50		V	
Collector-emitter breakdown voltage	$V_{(BR)CEO}$	$I_C = -10\text{mA}, I_B=0$	-45		V	
Emitter-base breakdown voltage	$V_{(BR)EBO}$	$I_E = -1\mu\text{A}, I_C=0$	-5		V	
Collector cut-off current	I_{CBO}	$V_{CB} = -45\text{V}, I_E=0$		-0.1	μA	
Emitter cut-off current	I_{EBO}	$V_{EB} = -4\text{V}, I_C=0$		-0.1	μA	
DC current gain	807-16	$h_{FE(1)}$	$V_{CE} = -1\text{V}, I_C = -100\text{mA}$	100	250	
	807-25	$h_{FE(2)}$	$V_{CE} = -1\text{V}, I_C = -100\text{mA}$	160	400	
	807-40	$h_{FE(3)}$	$V_{CE} = -1\text{V}, I_C = -100\text{mA}$	250	600	
Collector-emitter saturation voltage	$V_{CE(sat)}$	$I_C = -500\text{mA}, I_B = -50\text{mA}$		-0.7	V	
Base-emitter saturation voltage	$V_{BE(sat)}$	$I_C = -500\text{mA}, I_B = -50\text{mA}$		-1.2	V	
Transition frequency	f_T	$V_{CE} = -5\text{V}, I_C = -10\text{mA}$ $f=100\text{MHz}$	100		MHz	

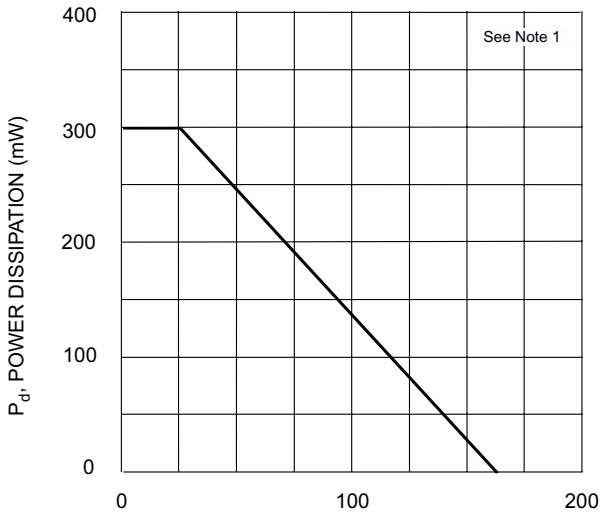

T_{SB} : SUBSTRATE TEMPERATURE ($^{\circ}C$)
Fig. 1, Power Derating Curve

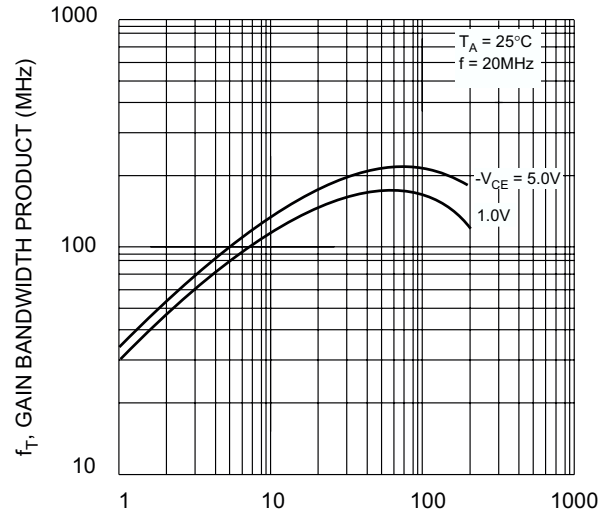

$-I_C$: COLLECTOR CURRENT (mA)
Fig. 2, Gain-Bandwidth Product vs. Collector Current

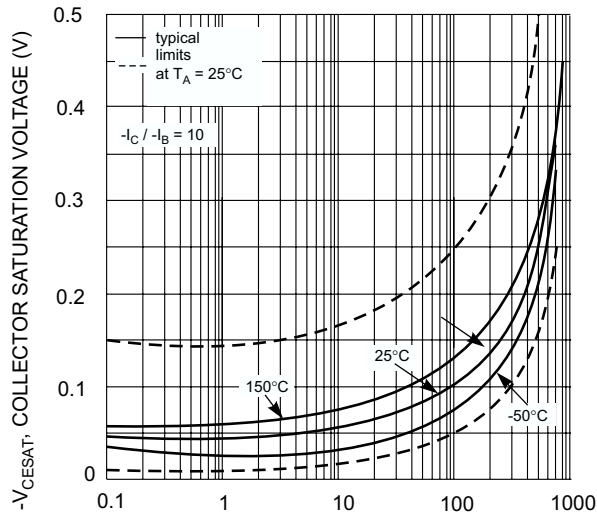

$-I_C$: COLLECTOR CURRENT (mA)
Fig. 3, Collector Sat. Voltage vs. Collector Current

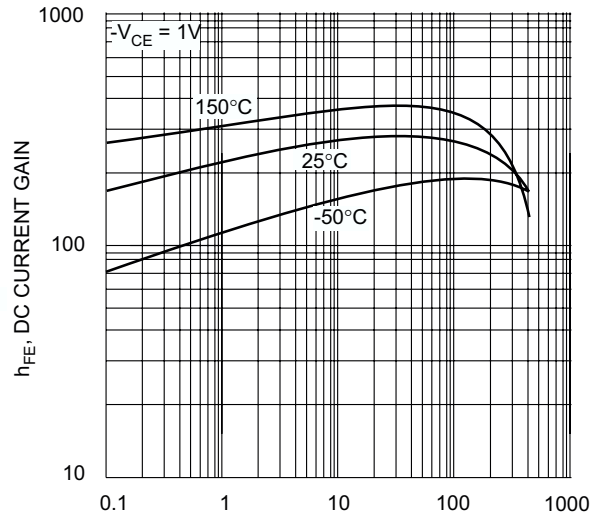

$-I_C$: COLLECTOR CURRENT (mA)
Fig. 4, DC Current Gain vs. Collector Current

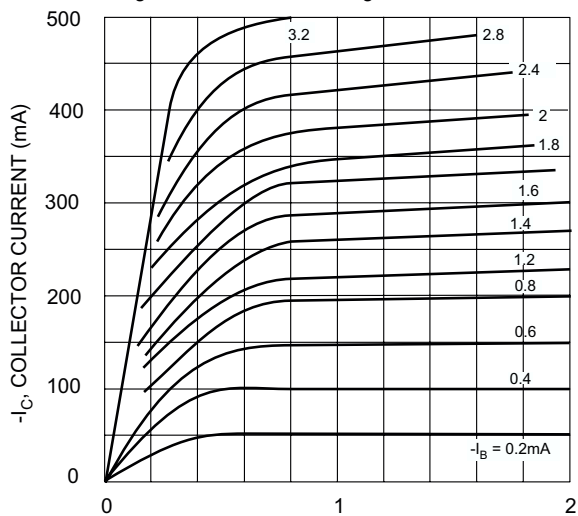

$-V_{CE}$: COLLECTOR-EMITTER VOLTAGE (V)
Fig. 5, Typical Emitter-Collector Characteristics

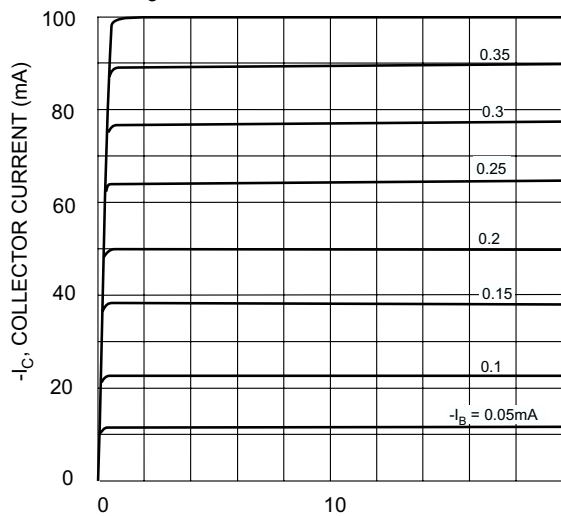

$-V_{CE}$: COLLECTOR-EMITTER VOLTAGE (V)
Fig. 6, Typical Emitter-Collector Characteristics

PACKAGE OUTLINE

Plastic surface mounted package; 3 leads

SOT-23

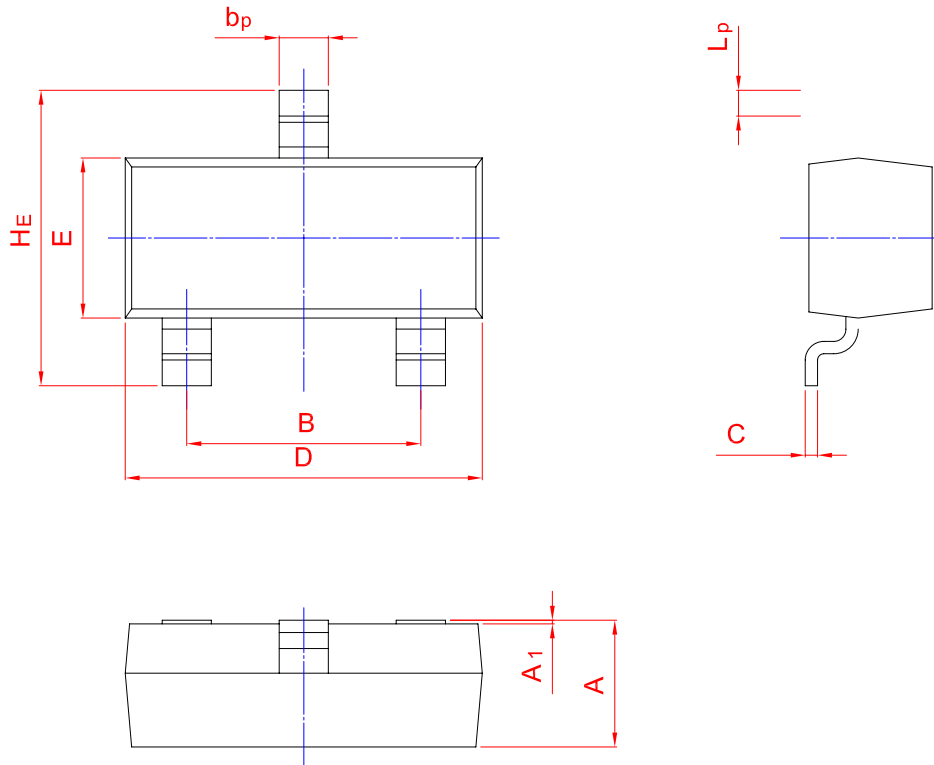

UNIT	A	B	b_p	C	D	E	$H\epsilon$	A_1	L_p
mm	1.40	2.04	0.50	0.19	3.10	1.65	3.00	0.100	0.50
	0.95	1.78	0.35	0.08	2.70	1.20	2.20	0.013	0.20