

SKM 75GB176D



SEMITRANS® 2

Trench IGBT Modules

SKM 75GB176D

Features

- Homogeneous Si
- Trench = Trenchgate technology
- $V_{CE(sat)}$ with positive temperature coefficient
- High short circuit capability, self limiting to $6 \times I_C$

Typical Applications*

- AC inverter drives mains 575 - 750 V AC
- Public transport (auxiliary syst.)

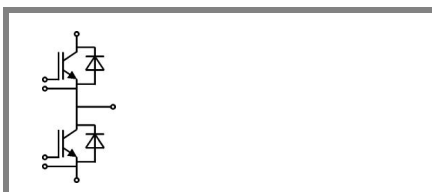

GB

Absolute Maximum Ratings		$T_{case} = 25^\circ\text{C}$, unless otherwise specified		
Symbol	Conditions	Values	Units	
IGBT				
V_{CES}	$T_j = 25^\circ\text{C}$	1700	V	
I_C	$T_j = 150^\circ\text{C}$	$T_c = 25^\circ\text{C}$	80	A
		$T_c = 80^\circ\text{C}$	55	A
I_{CRM}	$I_{CRM} = 2 \times I_{Cnom}$	100	A	
V_{GES}		± 20	V	
t_{psc}	$V_{CC} = 1200\text{ V}; V_{GE} \leq 20\text{ V}; T_j = 125^\circ\text{C}$ $V_{CES} < 1700\text{ V}$	10	μs	
Inverse Diode				
I_F	$T_j = 150^\circ\text{C}$	$T_c = 25^\circ\text{C}$	80	A
		$T_c = 80^\circ\text{C}$	55	A
I_{FRM}	$I_{FRM} = 2 \times I_{Fnom}$	100	A	
I_{FSM}	$t_p = 10\text{ ms}; \text{sin.}$	$T_j = 150^\circ\text{C}$	550	A
Module				
$I_{t(RMS)}$		200	A	
T_{vj}		-40 ... +150	$^\circ\text{C}$	
T_{stg}		-40 ... +125	$^\circ\text{C}$	
V_{isol}	AC, 1 min.	4000	V	

Characteristics		$T_{case} = 25^\circ\text{C}$, unless otherwise specified			
Symbol	Conditions	min.	typ.	max.	Units
IGBT					
$V_{GE(th)}$	$V_{GE} = V_{CE}, I_C = 2\text{ mA}$	5,2	5,8	6,4	V
I_{CES}	$V_{GE} = 0\text{ V}, V_{CE} = V_{CES}$			3	mA
V_{CE0}		$T_j = 25^\circ\text{C}$	1	1,2	V
		$T_j = 125^\circ\text{C}$	0,9	1,1	V
r_{CE}	$V_{GE} = 15\text{ V}$	$T_j = 25^\circ\text{C}$	20	25	m Ω
		$T_j = 125^\circ\text{C}$	31	36	m Ω
$V_{CE(sat)}$	$I_{Cnom} = 50\text{ A}, V_{GE} = 15\text{ V}$	$T_j = 25^\circ\text{C}_{chiplev.}$	2	2,45	V
		$T_j = 125^\circ\text{C}_{chiplev.}$	2,45	2,9	V
C_{res}	$V_{CE} = 25, V_{GE} = 0\text{ V}$	$f = 1\text{ MHz}$	4,3		nF
C_{oes}			0,18		nF
C_{res}			0,15		nF
Q_G	$V_{GE} = -8\text{V}...+15\text{V}$		410		nC
R_{Gint}	$T_j = 25^\circ\text{C}$		9,5		Ω
$t_{d(on)}$	$R_{Gon} = 6,2\ \Omega$ $di/dt = 1680\text{ A}/\mu\text{s}$	$V_{CC} = 1200\text{V}$ $I_C = 50\text{A}$	210		ns
t_r			30		ns
E_{on}			25		mJ
$t_{d(off)}$	$R_{Goff} = 6,2\ \Omega$ $di/dt = 320\text{ A}/\mu\text{s}$	$T_j = 125^\circ\text{C}$ $V_{GE} = \pm 15\text{V}$	590		ns
t_f			135		ns
E_{off}			18		mJ
$R_{th(j-c)}$	per IGBT			0,38	K/W

SKM 75GB176D



SEMITRANS® 2

Trench IGBT Modules

SKM 75GB176D

Features

- Homogeneous Si
- Trench = Trenchgate technology
- $V_{CE(sat)}$ with positive temperature coefficient
- High short circuit capability, self limiting to $6 \times I_C$

Typical Applications*

- AC inverter drives mains 575 - 750 V AC
- Public transport (auxiliary syst.)



GB

Characteristics			min.	typ.	max.	Units
Inverse Diode						
$V_F = V_{EC}$	$I_{Fnom} = 50 \text{ A}; V_{GE} = 0 \text{ V}$	$T_j = 25 \text{ }^\circ\text{C}_{chiplev.}$		1,7	1,9	V
		$T_j = 125 \text{ }^\circ\text{C}_{chiplev.}$		1,8	2	V
V_{F0}		$T_j = 25 \text{ }^\circ\text{C}$		1,1	1,3	V
		$T_j = 125 \text{ }^\circ\text{C}$		0,9	1,1	V
r_F		$T_j = 25 \text{ }^\circ\text{C}$		12	12	m Ω
		$T_j = 125 \text{ }^\circ\text{C}$		18	18	m Ω
I_{RRM}	$I_F = 50 \text{ A}$	$T_j = 125 \text{ }^\circ\text{C}$		52		A
Q_{rr}	$di/dt = 1320 \text{ A}/\mu\text{s}$			20		μC
E_{rr}	$V_{GE} = -15 \text{ V}; V_{CC} = 1200 \text{ V}$			14,5		mJ
$R_{th(j-c)D}$	per diode				0,55	K/W
Module						
L_{CE}					30	nH
$R_{CC'+EE'}$	res., terminal-chip	$T_{case} = 25 \text{ }^\circ\text{C}$		0,75		m Ω
		$T_{case} = 125 \text{ }^\circ\text{C}$		1		m Ω
$R_{th(c-s)}$	per module				0,05	K/W
M_s	to heat sink M6		3		5	Nm
M_t	to terminals M5		2,5		5	Nm
w					160	g

This is an electrostatic discharge sensitive device (ESDS), international standard IEC 60747-1, Chapter IX.

* The specifications of our components may not be considered as an assurance of component characteristics. Components have to be tested for the respective application. Adjustments may be necessary. The use of SEMIKRON products in life support appliances and systems is subject to prior specification and written approval by SEMIKRON. We therefore strongly recommend prior consultation of our personal.

SKM 75GB176D



SEMITRANS® 2

Trench IGBT Modules

SKM 75GB176D

Features

- Homogeneous Si
- Trench = Trenchgate technology
- $V_{CE(sat)}$ with positive temperature coefficient
- High short circuit capability, self limiting to $6 \times I_C$

Typical Applications*

- AC inverter drives mains 575 - 750 V AC
- Public transport (auxiliary syst.)

Z_{th}		Conditions	Values	Units
$Z_{th(j-c)I}$				
$R_{\theta j-c}$	$i = 1$		270	mk/W
$R_{\theta j-c}$	$i = 2$		85	mk/W
$R_{\theta j-c}$	$i = 3$		21	mk/W
$R_{\theta j-c}$	$i = 4$		4	mk/W
$\tau_{th(j-c)}$	$i = 1$		0,0393	s
$\tau_{th(j-c)}$	$i = 2$		0,0786	s
$\tau_{th(j-c)}$	$i = 3$		0,0014	s
$\tau_{th(j-c)}$	$i = 4$		0,0002	s
$Z_{th(j-c)D}$				
$R_{\theta j-cD}$	$i = 1$		360	mk/W
$R_{\theta j-cD}$	$i = 2$		150	mk/W
$R_{\theta j-cD}$	$i = 3$		36	mk/W
$R_{\theta j-cD}$	$i = 4$		4	mk/W
$\tau_{th(j-c)D}$	$i = 1$		0,0262	s
$\tau_{th(j-c)D}$	$i = 2$		0,0417	s
$\tau_{th(j-c)D}$	$i = 3$		0,0012	s
$\tau_{th(j-c)D}$	$i = 4$		0,001	s

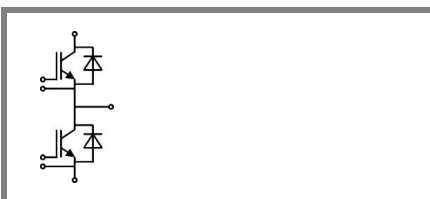

GB

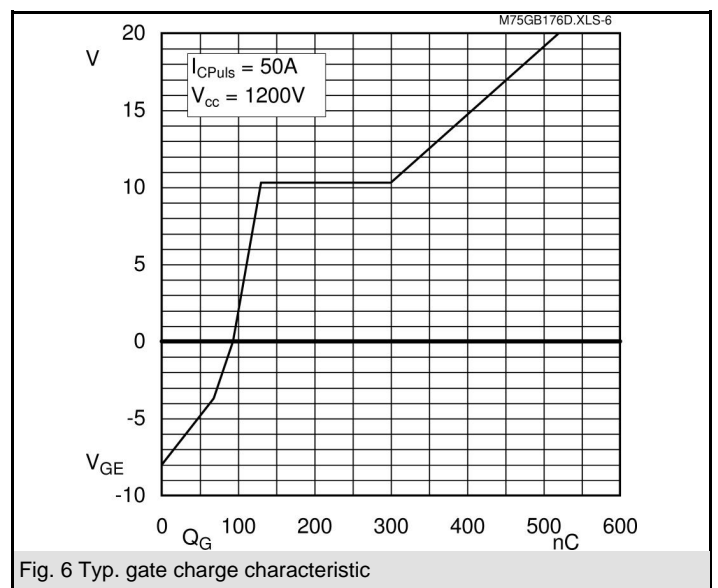
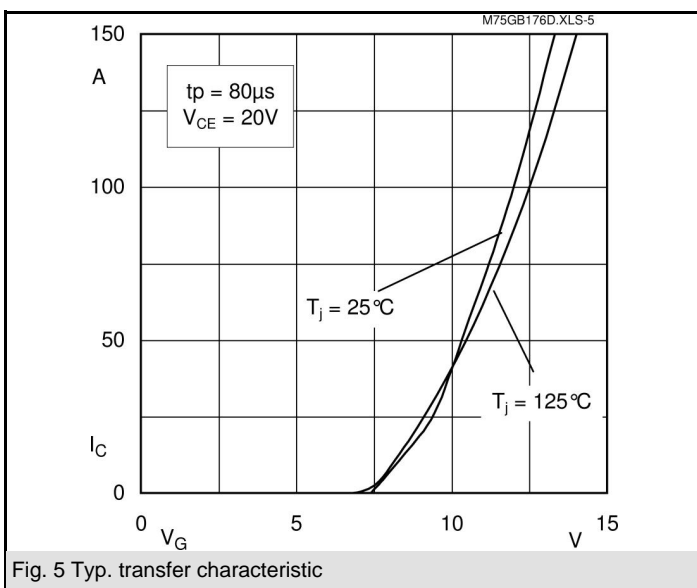
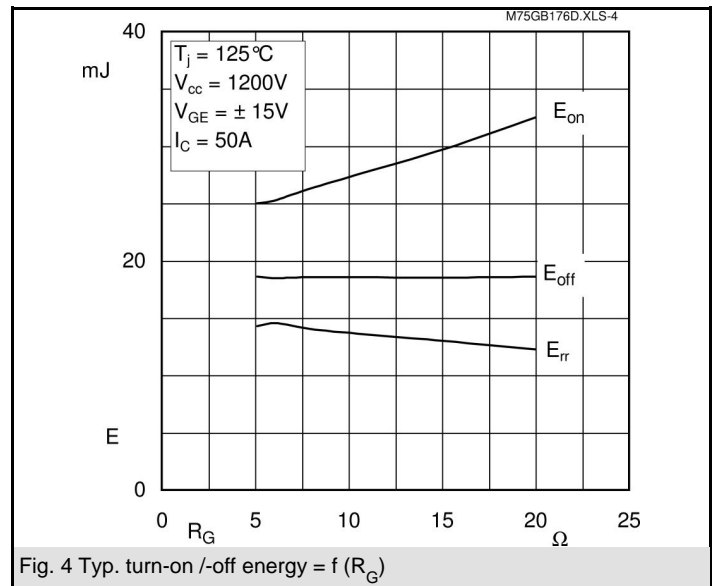
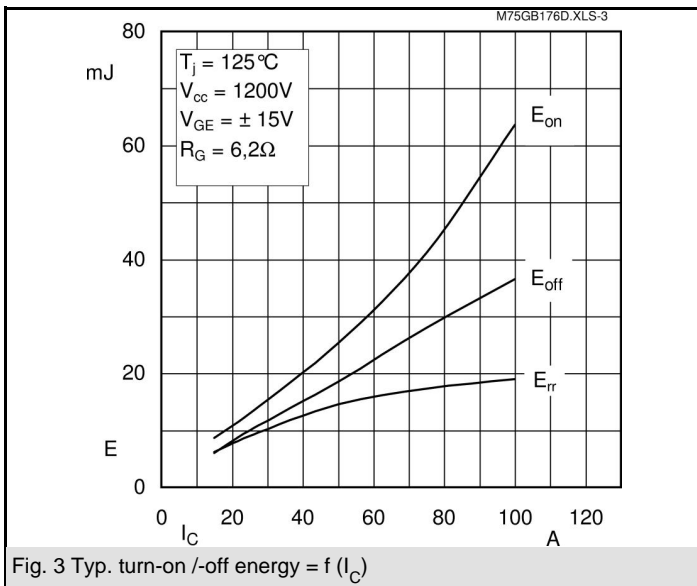
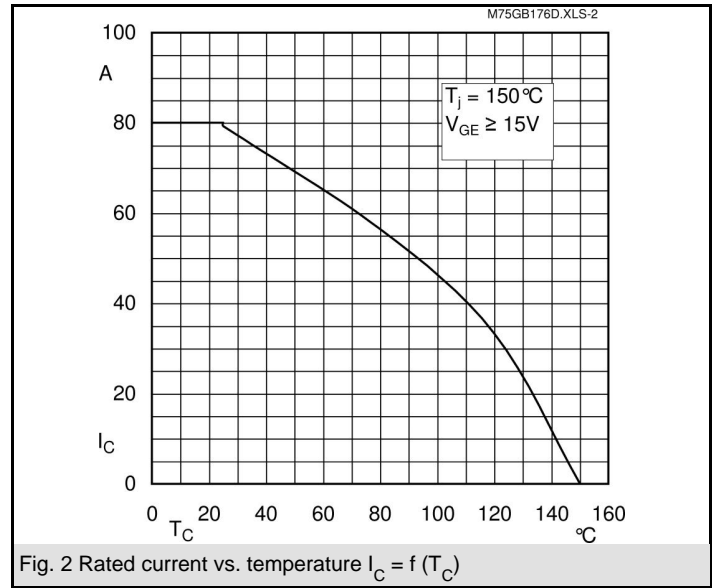
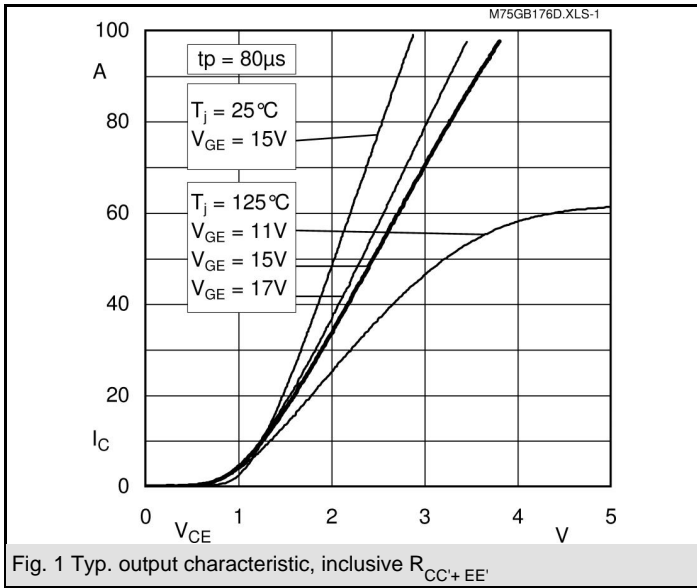

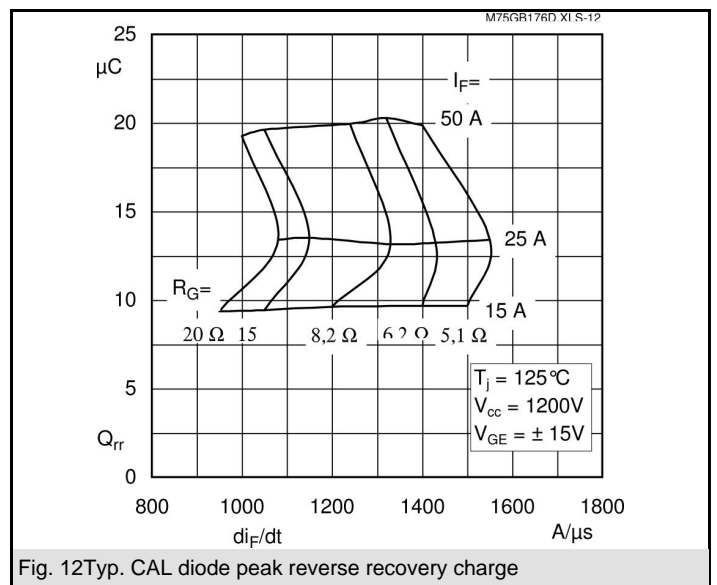
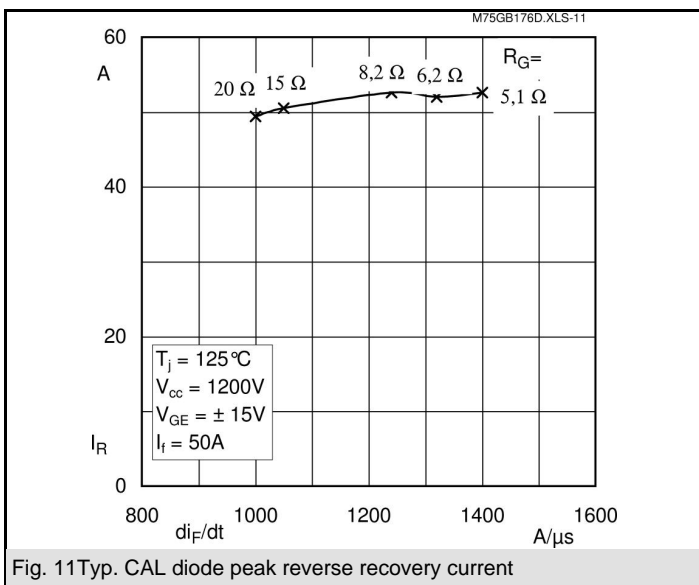
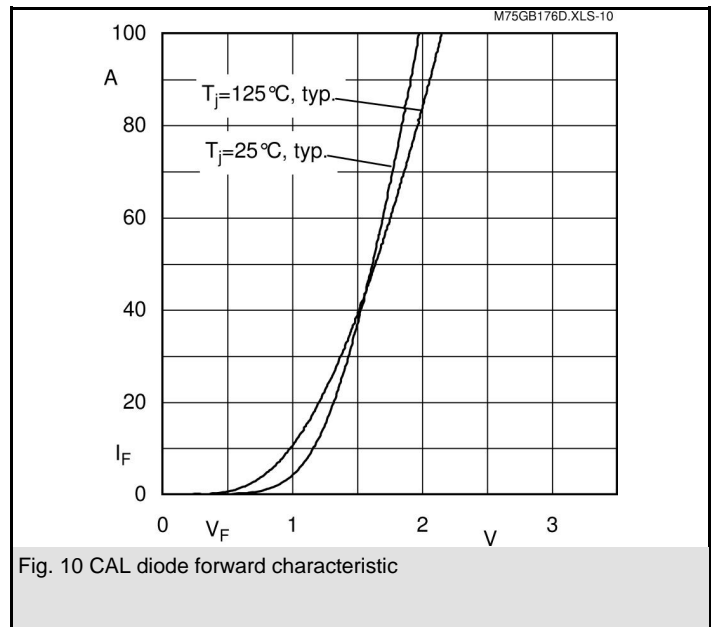
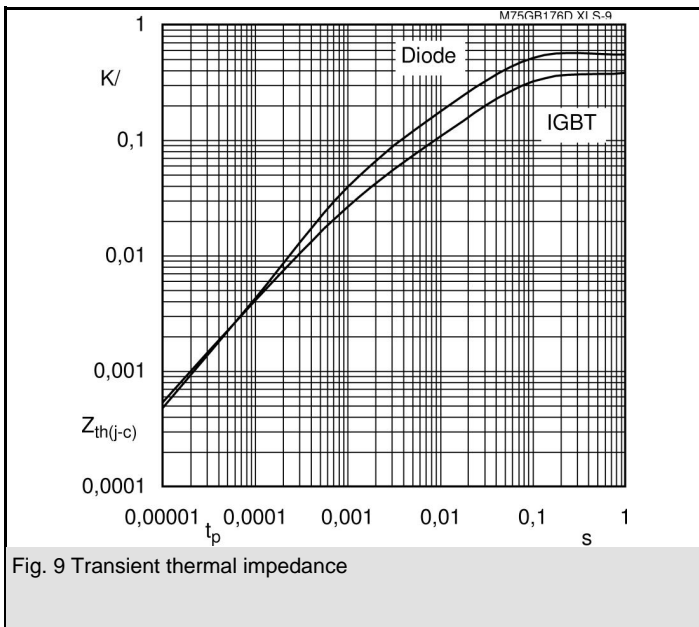
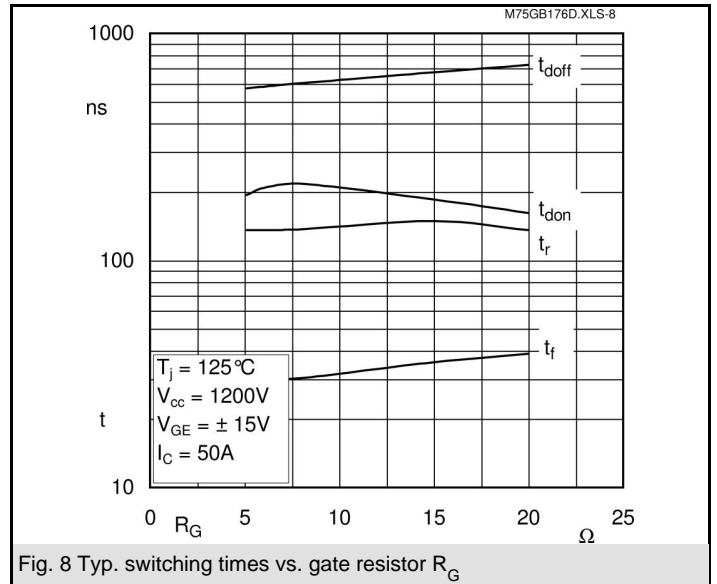
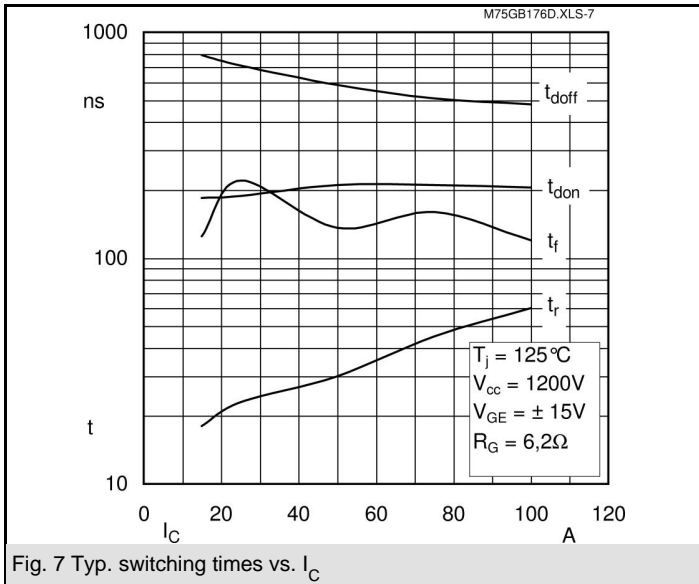

SKM 75GB176D

UL Regognized

CASED61

File no. E 63 532

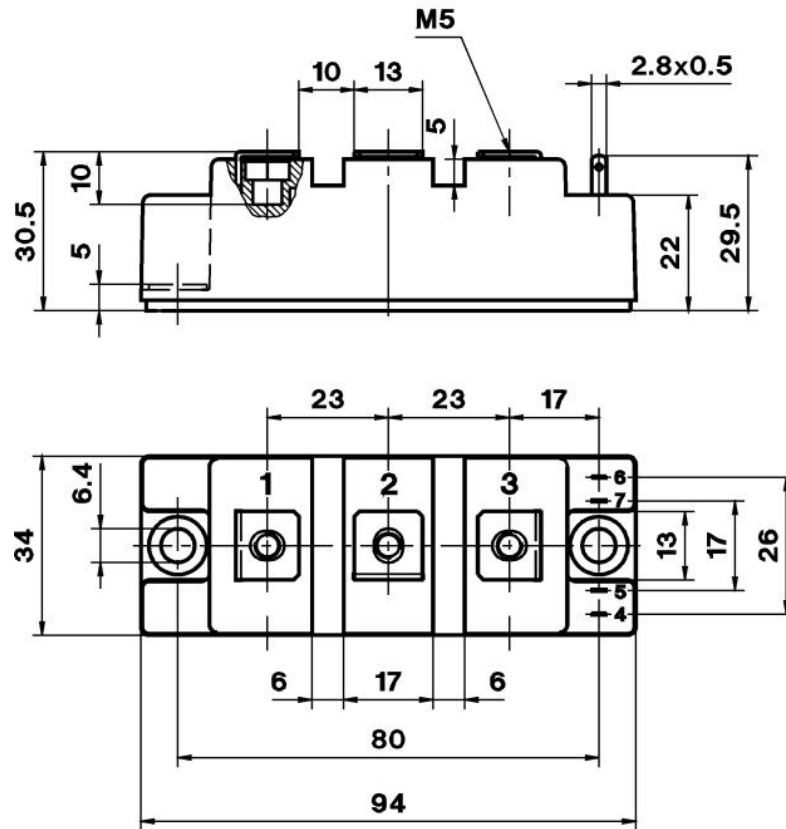

Case D 61

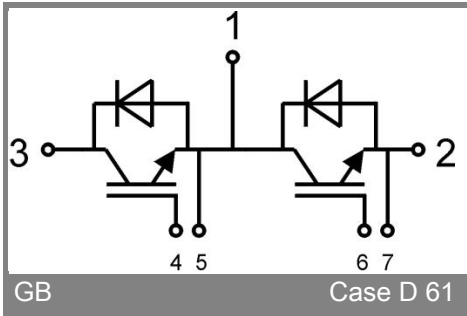

GB

Case D 61