

# Real Time Clock Module with I<sup>2</sup>C Bus

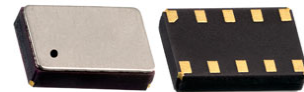

3.7 x 2.5 x 0.9 mm

AB-RTCMC-32.768kHz-B5ZE-S3



RoHS/RoHS II compliant

Moisture Sensitivity Level: MSL=1

## FEATURES:

- RTC module with built-in crystal oscillating at 32.768 kHz
- 1 MHz Fast-mode Plus (Fm+) two-wire I2C interface
- Wide Interface operating voltage: 1.6 – 5.5 V
- Wide clock operating voltage: 1.2 – 5.5 V
- Ultra low power consumption: 130 nA typ @ 3.0V / 25°C
- Provides year, month, day, weekday, hours, minutes, seconds
- Freely programmable Alarm and Timer functions with interrupt capability
- Low voltage detector, internal power on reset
- Battery backup input pin and switch-over circuit
- INT\_1 can be programmed either as interrupt or clock output (open-drain)
- Programmable clock output for peripheral devices (32.768 kHz, 16.384 kHz, 8192 Hz, 4096 Hz, 1024 Hz, 32 Hz and 1 Hz)
- Programmable offset register for frequency adjustment
- I2C slave address: read D1h, write D0h
- Small and compact package size: 3.7 x 2.5 x 0.9 mm. RoHS-compliant and 100% leadfree

## APPLICATIONS:

- Wide range in communication & measuring equipment
- Commercial & Industrial applications
- Automotive electronics applications
- Wireless communications
- PDA and Palm Pilots
- Credit Cards with Security Technology

## STANDARD SPECIFICATIONS:

### Absolute Maximum Ratings

Parameters	Min.	Typ.	Max.	Units	Notes
Supply Voltage (V <sub>DD</sub> )	-0.5		+6.5	V	
Battery Supply voltage (V <sub>BACKUP</sub> )	-0.5		+6.5	V	
Input Voltage (V <sub>I</sub> )	-0.5		+6.5	V	
Output Voltage (V <sub>O</sub> )	-0.5		+6.5	V	
Supply Current (I <sub>DD</sub> )	-50		+50	mA	
DC Input Current (I <sub>I</sub> )	-10		+10	mA	
DC Output Current (I <sub>O</sub> )	-10		+10	mA	
Operating Temperature Range (T <sub>OPR</sub> )	-40		+85	°C	
Storage Temperature (T <sub>STO</sub> )	-55		+125	°C	Stored as bare product

### Frequency Characteristics

Parameters	Min.	Typ.	Max.	Units	Notes
Frequency Accuracy (ΔF/F)		±10	±20	ppm	T <sub>AMB</sub> = +25°C; V <sub>DD</sub> = 3.0V
Frequency vs Voltage (ΔF/V)		±0.8	±1.5	ppm/V	T <sub>AMB</sub> = +25°C; V <sub>DD</sub> = 1.8~5.5V
Frequency vs Temperature ΔF/T <sub>OPR</sub> )	-0.035ppm/°C <sup>2</sup> (T <sub>OPR</sub> - T <sub>O</sub> ) <sup>2</sup> ±10%			ppm	T <sub>REF</sub> = +25°C; V <sub>DD</sub> = 3.0V
Turnover Temperature (T <sub>O</sub> )	+20	+25	+30	°C	
Aging (first year)	-3		+3	ppm	T <sub>AMB</sub> = +25°C
Oscillator Start-up Time (T <sub>START</sub> )		350	500	ms	T <sub>AMB</sub> = +25°C
CLKOUT duty cycle	40	50	60	%	T <sub>AMB</sub> = +25°C

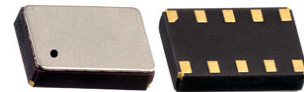

3.7 x 2.5 x 0.9 mm

AB-RTCMC-32.768kHz-B5ZE-S3



RoHS/RoHS II compliant

## Static Characteristics

$V_{DD} = 1.2V$  to  $5.5V$ ;  $V_{SS} = 0V$ ;  $T_{AMB} = -40^{\circ}C$  to  $+85^{\circ}C$ ;  $f_{OSC} = 32.768$  kHz; unless otherwise specified

Parameters		Min.	Typ.	Max.	Units	Notes
Supply Voltage ( $V_{DD}$ )	For clock data integrity I <sup>2</sup> C bus inactive	1.2		5.5	V	
	I <sup>2</sup> C bus active	1.6		5.5		
	Power management function active	1.8		5.5		
Slew Rate (SR)	Of $V_{DD}$			$\pm 0.5$	V/ms	
Battery Supply Voltage ( $V_{BACKUP}$ )	Power management function active	1.8		5.5	V	
Current Consumption ( $I_{DD}$ ) I <sup>2</sup> C bus active	$f_{SCL} = 1000$ kHz $V_{DD} = 3.0V$		100	200	$\mu A$	
	$f_{SCL} = 100$ kHz $V_{DD} = 3.0V$		50	100	$\mu A$	
Current Consumption ( $I_{DD0}$ ) 1)	$V_{DD} = 3.0V$		130	180	nA	I <sup>2</sup> C bus inactive ( $f_{SCL} = 0$ Hz) Interrupts disabled CLKOUT disabled Power management fct. disabled (PM[2:0] = 111) $T_{amb} = +25^{\circ}C$
	$V_{DD} = 2.0V$		110	160	nA	
Current Consumption ( $I_{DD0}$ ) 1)	$V_{DD} = 2.0$ to $5.0V$			500	nA	I <sup>2</sup> C bus inactive ( $f_{SCL} = 0$ Hz) Interrupts disabled CLKOUT disabled Power management fct. disabled (PM[2:0] = 111) $T_{amb} = -40 \sim +85^{\circ}C$
Current Consumption ( $I_{DD32k}$ ) <sup>2)</sup>	$V_{BACKUP}$ or $V_{DD} = 3.0V$		1200		nA	I <sup>2</sup> C bus inactive ( $f_{SCL} = 0$ Hz) Interrupts disabled CLKOUT enabled (32.768kHz) Power management fct. enabled (PM[2:0] = 00 0) $T_{amb} = +25^{\circ}C$
Current Consumption ( $I_{DD32k}$ ) <sup>2)</sup>	$V_{BACKUP}$ or $V_{DD} = 2.0$ to $5.0V$			3600	nA	I <sup>2</sup> C bus inactive ( $f_{SCL} = 0$ Hz) Interrupts disabled CLKOUT enabled (32.768kHz) Power management fct. enabled (PM[2:0] = 000) $T_{amb} = -40 \sim +85^{\circ}C$
Battery Leakage Current ( $I_{L(bat)}$ )	$V_{DD}$ active; $V_{BACKUP} = 3.0V$		50	100	nA	

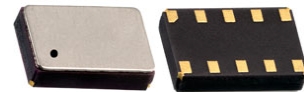

(Continued)

$V_{DD} = 1.2\text{ V to } 5.5\text{ V}; V_{SS} = 0\text{ V}; T_{AMB} = -40^{\circ}\text{C to } +85^{\circ}\text{C}; f_{OSC} = 32.768\text{ kHz};$  unless otherwise specified

Parameters	Min.	Typ.	Max.	Units	Notes	
<b>Power Management</b>						
Battery Switch Threshold Voltage ( $V_{th(sw)bat}$ )	2.28	2.5	2.7	V		
<b>Inputs</b> <sup>3)</sup>						
LOW Level Input Voltage ( $V_{IL}$ )			$30\%V_{DD}$	V		
HIGH Level Input Voltage ( $V_{IH}$ )	$70\%V_{DD}$			V		
Input Voltage ( $V_I$ )	-0.5		$V_{DD}+0.5$	V		
Input Leakage Current( $I_L$ )	$V_I = V_{DD}$ or $V_{SS}$		0	nA		
	Post ESD Event	-1		+1	$\mu\text{A}$	
Input Capacitance( $C_I$ ) <sup>4)</sup>			7	pF		
<b>Outputs</b>						
Output Voltage ( $V_O$ )	On pin $\overline{\text{INT}}_1$ , $\overline{\text{INT}}_2$ , CLKOUT, SDA (refers to ext. pull-up voltage)		-0.5		+5.5	V
LOW Level Output Voltage ( $V_{OL}$ )			$V_{SS}$		0.4	V
LOW Level Output Current ( $I_{OL}$ ) <sup>5)</sup>	Output sink current; On pin $\overline{\text{INT}}_1$ , $\overline{\text{INT}}_2$ , CLKOUT $V_{OL}=0.4\text{V}; V_{DD}=5.0\text{V}$		1.5			mA
	On pin SDA $V_{OL}=0.4\text{V}; V_{DD}=3.0\text{V}$		20			
Output Leakage Current ( $I_{LO}$ )	$V_O = V_{DD}$ or $V_{SS}$				0	nA
	Post ESD Event		-1		+1	$\mu\text{A}$

1) Timer source clock = 1/3600 Hz, level of pins SCL and SDA is  $V_{SS}$  or  $V_{DD}$ .

2) When the device is supplied via the  $V_{BACKUP}$  pin instead of the  $V_{DD}$  pin, the current values for  $I_{BACKUP}$  will be as specified for  $I_{DD}$  under the same conditions.

3) The I<sup>2</sup>C bus is 5V tolerant.

4) Implicit by design.

5) Tested on sample basis.

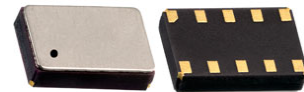

## I<sup>2</sup>C Interface Dynamic Characteristics

Parameters	Symbol	Standard Mode		Fast Mode (FM)		Fast Mode Plus (FM+) <sup>1)</sup>		Units
		Min.	Max.	Min.	Max.	Min.	Max.	
<b>Pin SCL</b>								
SCL clock frequency <sup>2)</sup>	f <sub>SCL</sub>		100		400		1000	kHz
LOW period of SCL clock	t <sub>LOW</sub>	4.7		1.3		0.5		µs
HIGH period of SCL clock	t <sub>HIGH</sub>	4.0		1.6		0.26		µs
<b>Pin SDA</b>								
Data setup time	t <sub>SU;DAT</sub>	250		100		50		ns
Data hold time	t <sub>HD;DAT</sub>	0		0		0		ns
<b>Pin SCL and SDA</b>								
Bus free time between STOP and START condition	t <sub>BUF</sub>	4.7		1.3		0.5		µs
Setup time for STOP condition	t <sub>SU;STO</sub>	4.0		0.6		0.26		µs
Hold time (repeated) START condition	t <sub>HD;STA</sub>	4.0		0.6		0.26		µs
Setup time for repeated START condition	t <sub>SU;STA</sub>	4.7		0.6		0.26		µs
Rise time of both SDA and SCL signals <sup>3) 4)</sup>	t <sub>r</sub>		1000	20+0.1C <sub>b</sub>	300		120	ns
Fall time of both SDA and SCL signals <sup>3) 4)</sup>	t <sub>f</sub>		300	20+0.1C <sub>b</sub>	300		120	ns
Capacitive load for each bus line	C <sub>b</sub>		400		400		550	pF
Data valid acknowledge time <sup>5)</sup>	t <sub>VD;ACK</sub>		3.45		0.9		0.45	µs
Data valid time <sup>6)</sup>	t <sub>VD;DAT</sub>		3.45		0.9		0.45	µs
Pulse width of spikes that must be suppressed by the input filter <sup>7)</sup>	t <sub>SP</sub>		50		50		50	ns

1) Fast mode plus guaranteed at 3.0 V < V<sub>DD</sub> < 5.5 V.

2) The minimum SCL clock frequency is limited by the bus timeout feature, which resets the serial bus interface if either the SDA or SCL is held LOW for a minimum of 25 ms. The bus timeout feature must be disabled for DC operation.

3) A master device must internally provide a hold time of at least 300 ns for the SDA signal (refer to the V<sub>IL</sub> of the SCL signal) in order to bridge the undefined region of the falling edge of SCL.

4) The maximum t<sub>r</sub> for the SDA and SCL bus lines is 300 ns. The maximum fall time for the SDA output stage, t<sub>f</sub> is 250 ns. This allows series protection resistors to be connected between the SDA pin, the SCL pin and the SDA/SCL bus lines without exceeding the maximum t

5) t<sub>VD;ACK</sub> = time for acknowledgement signal from SCL LOW to SDA output LOW.

6) t<sub>VD;DAT</sub> = minimum time for valid SDA output following SCL LOW.

7) Input filters on the SDA and SCL inputs suppress noise spikes of less than 50 ns.

## I<sup>2</sup>C Interface Timing Characteristics

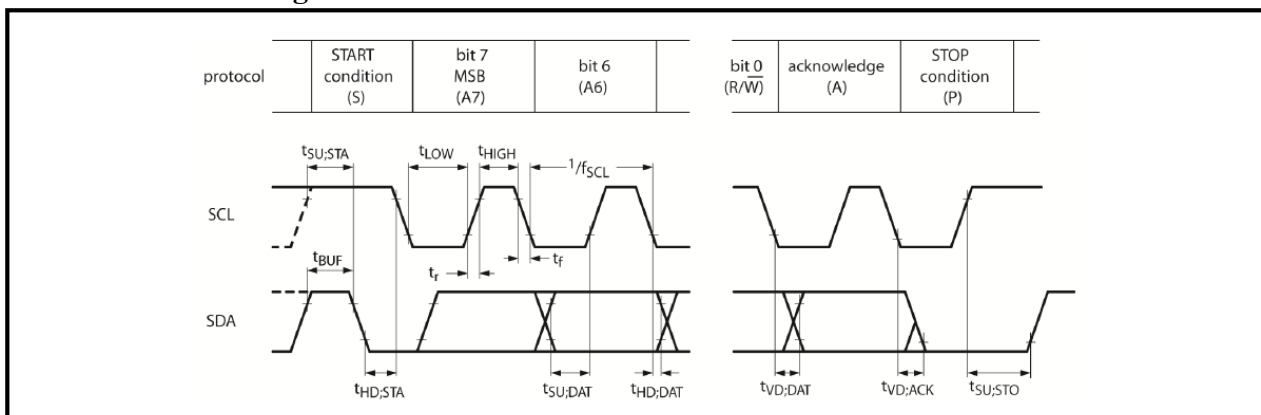

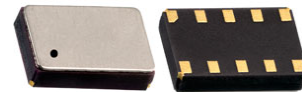

3.7 x 2.5 x 0.9 mm

AB-RTCMC-32.768kHz-B5ZE-S3



RoHS/RoHS II compliant

## PART IDENTIFICATIONS:

AB -RTCMC -32.768 kHz-B5ZE -S3-



**Packaging**

Blank: Bulk

T: 1000pcs/reel

## OUTLINE DIMENSIONS:

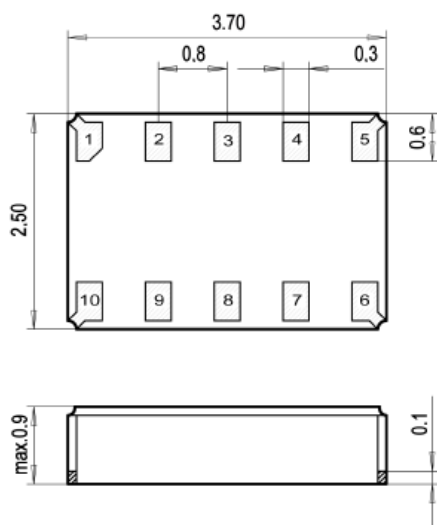

### Recommended Land Pattern

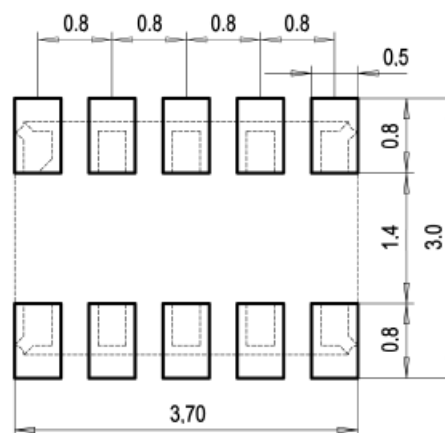

Dimensions: mm

## PIN DESCRIPTIONS:

Pin No.	Pin Name	Function
1	V <sub>DD</sub>	Power Supply Voltage
2	INT_1	Interrupt_1 Output pin
3	SCL	Serial Clock Input pin
4	SDA	Serial Data Input-Output pin
5	CLKOUT	Clock Output pin; open-drain; requires pull-up resistor
6	INT_2	Interrupt_2 Output pin
7	V <sub>SS</sub>	Ground
8	V <sub>BACKUP</sub>	Backup Supply Voltage
9	N.C.	Not Connected
10	N.C.	Not Connected

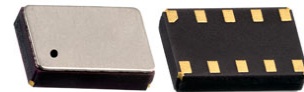

## BLOCK DIAGRAM:

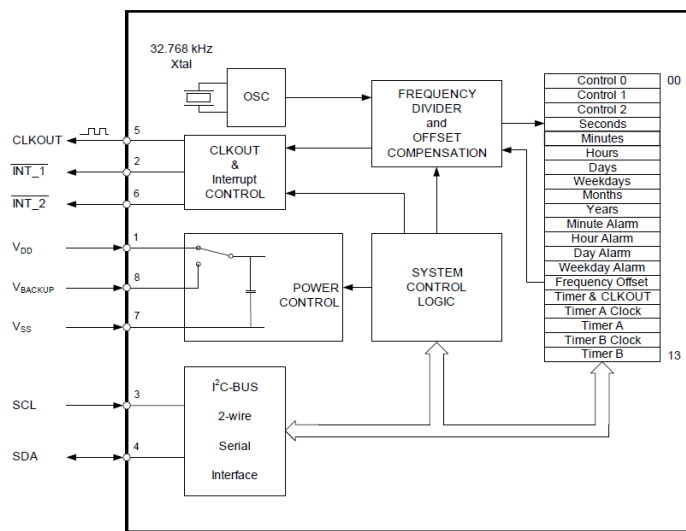

## RECOMMENDED REFLOW PROFILE:

Maximum Reflow Conditions in accordance with IPC/JEDEC J-STD-020C “Pb-free”

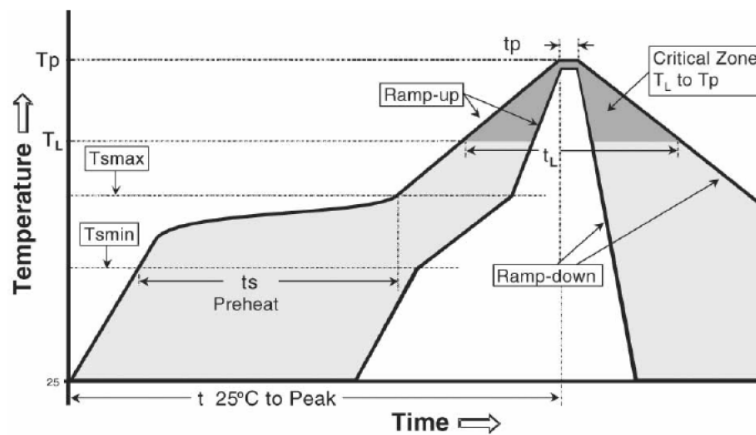

Temperature	Conditions	Units
Average Ramp-up Rate (T <sub>Smax</sub> to T <sub>p</sub> )	3°C/second max	°C/s
Ramp Down Rate (T <sub>cool</sub> )	6°C/second max	°C/s
Time 25°C to Peak Temperature (T <sub>to-peak</sub> )	8 minutes max	m
<b>Preheat</b>		
Temperature Min (T <sub>Smin</sub> )	150	°C
Temperature Max (T <sub>Smax</sub> )	200	°C
Time T <sub>Smin</sub> to T <sub>Smax</sub> (t <sub>s</sub> )	60 ~ 180	sec
<b>Time Above Liquidus</b>		
Temperature Liquidus (T <sub>L</sub> )	217	°C
Time above Liquidus (t <sub>L</sub> )	60 ~ 150	sec
<b>Peak Temperature</b>		
Peak Temperature (T <sub>p</sub> )	260	°C
Time within 5°C of Peak Temperature (t <sub>p</sub> )	20 ~ 40	sec

# Real Time Clock Module with I<sup>2</sup>C Bus

AB-RTCMC-32.768kHz-B5ZE-S3



RoHS/RoHS II compliant

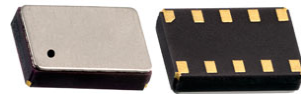

3.7 x 2.5 x 0.9 mm

## TAPE & REEL:

T = 1000pcs/reel

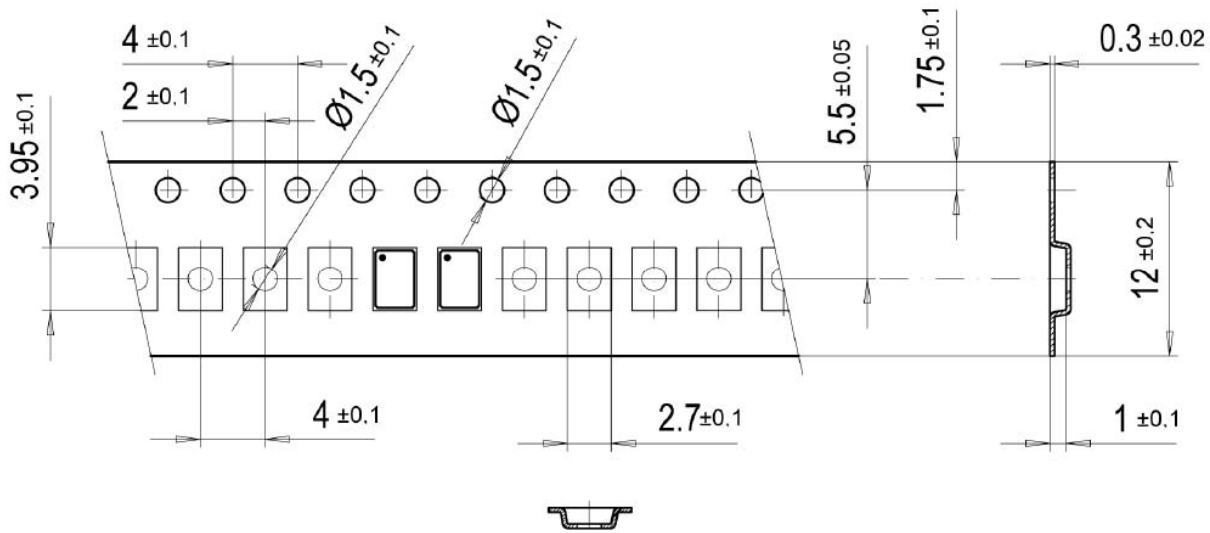

➔ User Direction of Feed

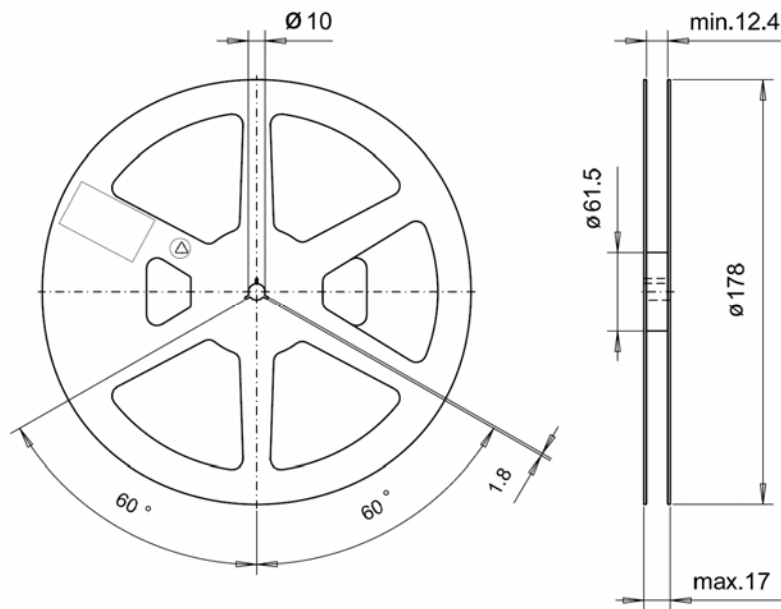

Dimension: mm

**ATTENTION:** Abracon LLC's products are COTS – Commercial-Off-The-Shelf products; suitable for Commercial, Industrial and, where designated, Automotive Applications. Abracon's products are not specifically designed for Military, Aviation, Aerospace, Life-dependant Medical applications or any application requiring high reliability where component failure could result in loss of life and/or property. For applications requiring high reliability and/or presenting an extreme operating environment, written consent and authorization from Abracon LLC is required. Please contact Abracon LLC for more information.