

SCHOTTKY RECTIFIER

2.1 Amp

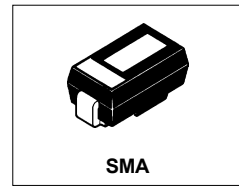

Major Ratings and Characteristics

Characteristics	10MQ100N	Units
I_F DC	2.1	A
V_{RRM}	100	V
I_{FSM} @tp=5 μ s sine	120	A
V_F @1.5Apk, $T_J=125^\circ\text{C}$	0.68	V
T_J range	-55 to 150	$^\circ\text{C}$

Description/Features

The 10MQ100N surface mount Schottky rectifier has been designed for applications requiring low forward drop and very small foot prints on PC boards. Typical applications are in disk drives, switching power supplies, converters, free-wheeling diodes, battery charging, and reverse battery protection.

- Small foot print, surface mountable
- Low forward voltage drop
- High frequency operation
- Guard ring for enhanced ruggedness and long term reliability

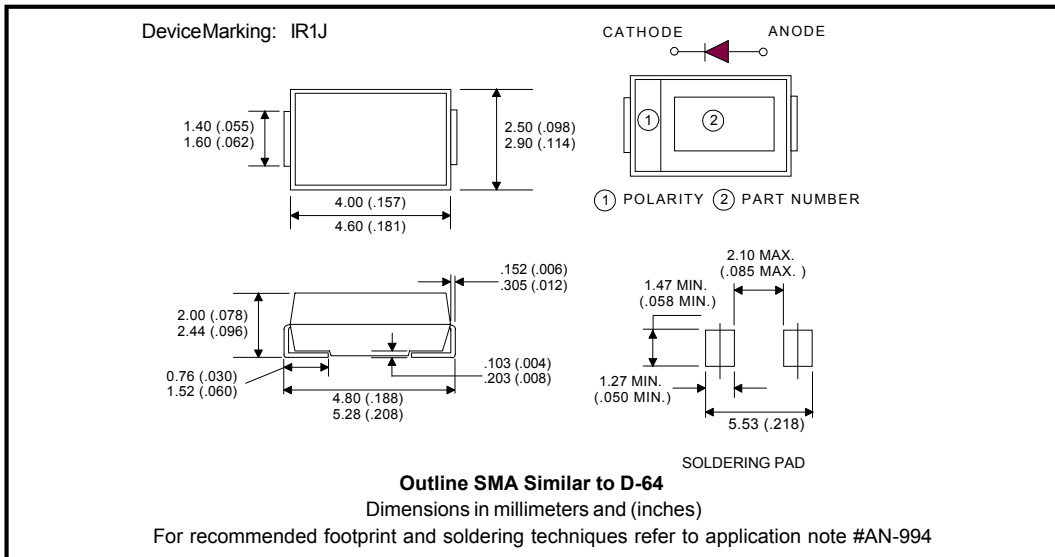

Voltage Ratings

Part number	10MQ100N
V_R Max. DC Reverse Voltage (V)	100
V_{RWM} Max. Working Peak Reverse Voltage (V)	

Absolute Maximum Ratings

Parameters	10MQ	Units	Conditions
$I_{F(AV)}$ Max. Average Forward Current * See Fig. 4	1.5	A	50% duty cycle @ $T_L = 126^\circ\text{C}$, rectangular waveform. On PC board 9mm ² island (.013mm thick copper pad area)
I_{FSM} Max. Peak One Cycle Non-Repetitive Surge Current * See Fig. 6	120	A	Following any rated load condition and with rated V_{RWM} applied
	30		
E_{AS} Non-Repetitive Avalanche Energy	3.0	mJ	$T_J = 25^\circ\text{C}$, $I_{AS} = 0.8\text{A}$, $L = 10\text{mH}$
I_{AR} Repetitive Avalanche Current	0.2	A	

Electrical Specifications

Parameters	10MQ	Units	Conditions
V_{FM} Max. Forward Voltage Drop (1) * See Fig. 1	0.78	V	@ 1A
	0.85	V	@ 1.5A
	0.63	V	@ 1A
	0.68	V	@ 1.5A
I_{RM} Max. Reverse Leakage Current (1) * See Fig. 2	0.1	mA	$T_J = 25^\circ\text{C}$
	1	mA	$T_J = 125^\circ\text{C}$
$V_{F(TO)}$ Threshold Voltage	0.52	V	$T_J = T_J \text{ max.}$
r_t Forward Slope Resistance	78.4	m Ω	
C_T Typical Junction Capacitance	38	pF	$V_R = 10V_{DC}$, $T_J = 25^\circ\text{C}$, test signal = 1Mhz
L_S Typical Series Inductance	2.0	nH	Measured lead to lead 5mm from package body
dv/dt Max. Voltage Rate of Change (Rated V_R)	10000	V/ μs	

(1) Pulse Width < 300 μs , Duty Cycle < 2%

Thermal-Mechanical Specifications

Parameters	10MQ	Units	Conditions
T_J Max. Junction Temperature Range (*)	-55 to 150	$^\circ\text{C}$	
T_{stg} Max. Storage Temperature Range	-55 to 150	$^\circ\text{C}$	
R_{thJA} Max. Thermal Resistance Junction to Ambient	80	$^\circ\text{C/W}$	DC operation
wt Approximate Weight	0.07(0.002)	g(oz.)	
Case Style	SMA		Similar D-64
Device Marking	IR1J		

(*) $\frac{dP_{tot}}{dT_J} < \frac{1}{R_{th(j-a)}}$ thermal runaway condition for a diode on its own heatsink

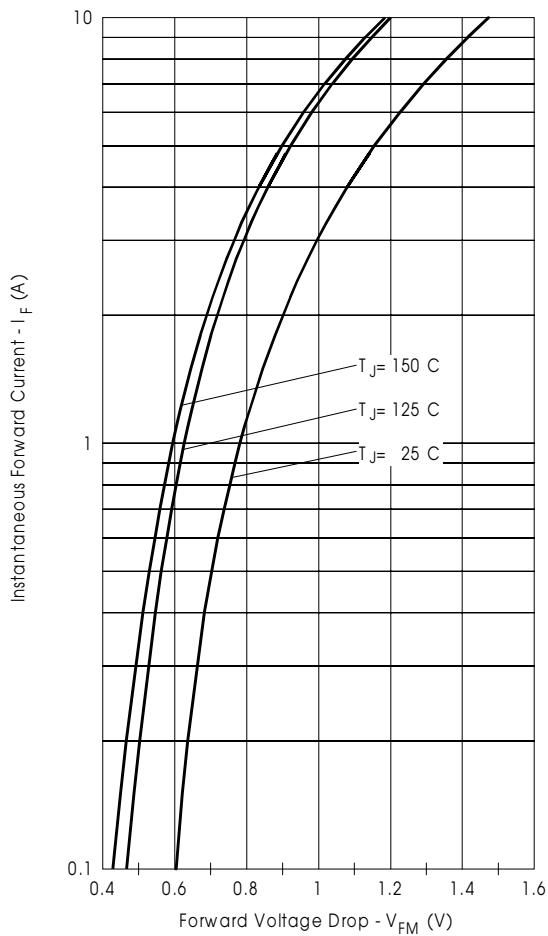

Fig. 1 - Maximum Forward Voltage Drop Characteristics

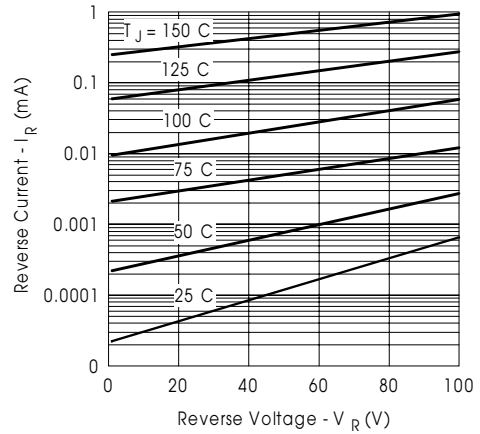

Fig. 2 - Typical Peak Reverse Current Vs. Reverse Voltage

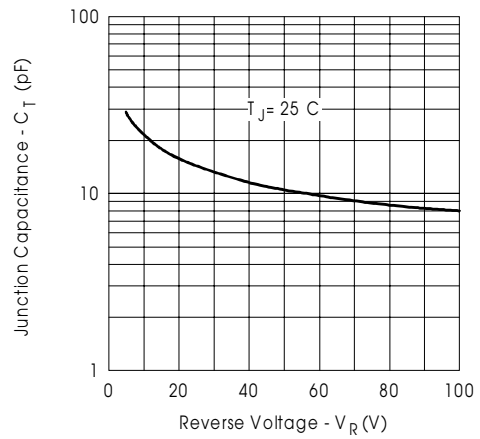

Fig. 3 - Typical Junction Capacitance Vs. Reverse Voltage

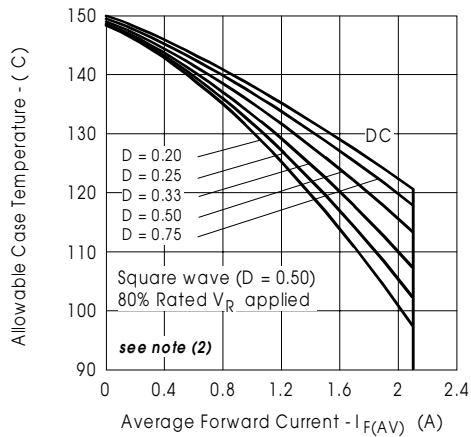

Fig. 4- Maximum Average Forward Current Vs. Allowable Lead Temperature

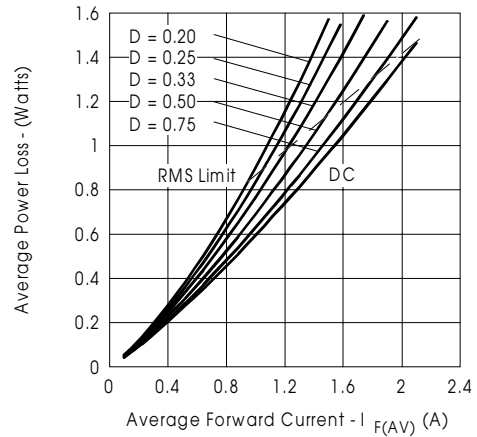

Fig. 5- Maximum Average Forward Dissipation Vs. Average Forward Current

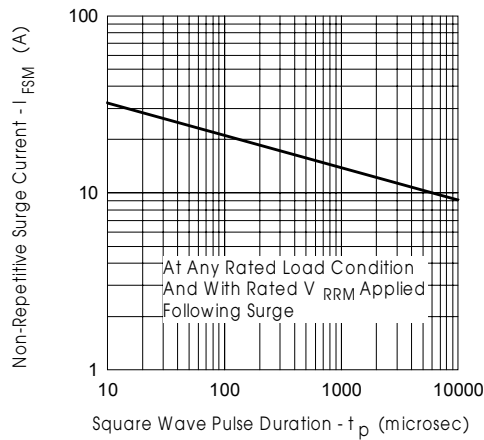

Fig. 6- Maximum Peak Surge Forward Current Vs. Pulse Duration

(2) Formula used: $T_c = T_j - (P_d + P_{d_{REV}}) \times R_{thJC}$;

P_d = Forward Power Loss = $I_{F(AV)} \times V_{FM} @ (I_{F(AV)} / D)$ (see Fig. 6);

$P_{d_{REV}}$ = Inverse Power Loss = $V_{R1} \times I_{R1} (1 - D)$; $I_{R1} @ V_{R1} = 80\%$ rated V_R

Tape & Reel Information

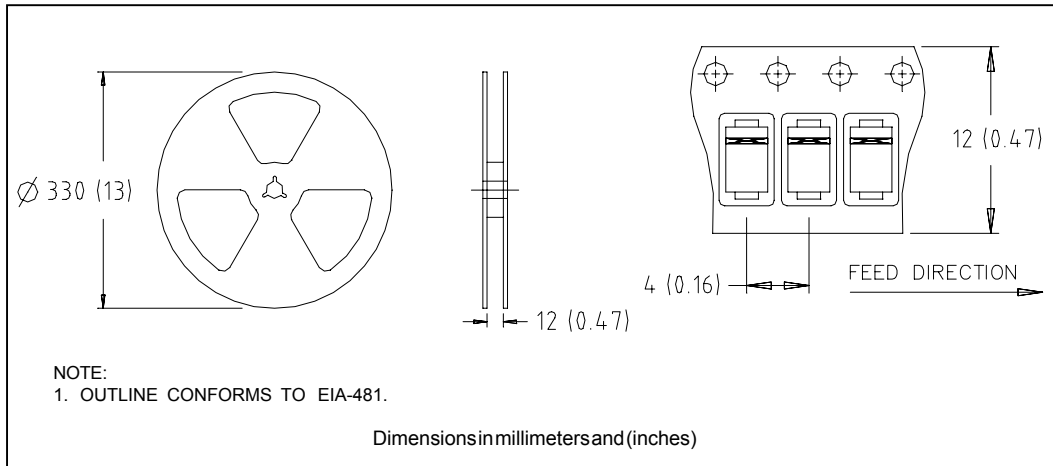

Marking & Identification

Each device has 8 characters, configured 4 digits on two rows, for identification. The first row designates the device as manufactured by International Rectifier as indicated by the letters "IR", and the Part Number (indicates the current rating and voltage/process). The second row indicates the year and the week of manufacturing.

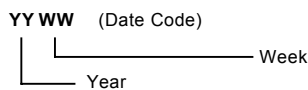
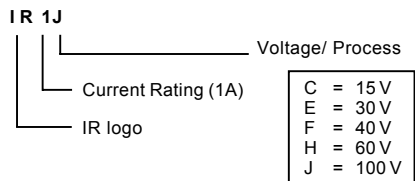
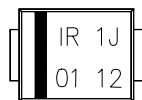

Ordering Information

10MQSERIES - TAPE AND REEL

WHEN ORDERING, INDICATE THE PART NUMBER AND THE QUANTITY (IN MULTIPLES OF 7500 PIECES).

EXAMPLE: 10MQ100TR - 15000PIECES

10MQSERIES - BULK QUANTITIES

WHEN ORDERING, INDICATE THE PART NUMBER AND THE QUANTITY (IN MULTIPLES OF 1000 PIECES).

EXAMPLE: 10MQ100 - 2000PIECES

10MQ100N

Bulletin PD-20520 rev. G 02/02

International
IOR Rectifier

Data and specifications subject to change without notice.
This product has been designed and qualified for Industrial Level.
Qualification Standards can be found on IR's Web site.

International
IOR Rectifier

IR WORLD HEADQUARTERS: 233 Kansas St., El Segundo, California 90245, USA Tel: (310) 252-7105
TAC Fax: (310) 252-7309

Visit us at www.irf.com for sales contact information. 02/02